



Page 3-2

**FOR BG SERIES MINI-CONTACTORS**

- Type RF9, phase failure sensitive, manual resetting
- Type RFA9, phase failure sensitive, automatic resetting
- Type RFN9, non phase failure sensitive, manual resetting
- Type RFNA9, non phase failure sensitive, automatic resetting.



Page 3-4

**FOR BF SERIES CONTACTORS**

- Type RF38, phase failure sensitive, manual or automatic resetting
- Type RFN38, non phase failure sensitive, manual or automatic resetting
- Type RF82 and RF95, phase failure sensitive, manual resetting
- Type RFA82 and RFA95, phase failure sensitive, automatic resetting
- Type RFN82 and RFN95, non phase failure sensitive, manual resetting
- Type RFNA82 and RFNA95, non phase failure sensitive, automatic resetting.



Page 3-8

**FOR B SERIES CONTACTORS**

- Type RF200 and RF420, phase failure sensitive, manual or automatic resetting
- Type RFN200 and RFN420, non phase failure sensitive, manual or automatic resetting.



Page 3-11

**THERMISTOR PROTECTION RELAY**

- 24VDC and 24 to 240VAC supply types.

**RF38 features**

**FRONT PROTECTION COVER OF THERMAL OVERLOAD RELAYS**

A sealable protection cover is available. When fitted on to the relay front, it precludes all possible adjuster tampering and involuntary activation of the "Reset" and "Stop" buttons of the thermal overload relay.



**CLEAR IDENTIFICATION OF THERMAL OVERLOAD RELAY MANUAL OR AUTOMATIC RESETTING**

The RF38 thermal overload relay is supplied configured for manual resetting. Breaking the plate below the "Reset" button allows for the automatic resetting configuration.



**FIXING EASE OF THE THERMAL OVERLOAD RELAY**

While the thermal overload relay is being linked to the contactor, its auxiliary contact fits on and connects to the coil terminal by rigid terminal. Complete relay fixing is done in a single operation, with no need of other connections.

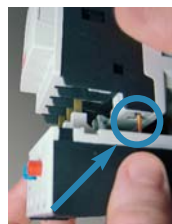

**SEALABLE RELAY COVER**

A handy closing flap feature excludes any tampering of the thermal overload relay adjuster.





- Thermal overload relays for currents between 0.09 and 420A
- Phase failure sensitive and non phase failure sensitive versions
- Automatic and/or manual resetting
- Independent or direct mounting on contactor
- Thermistor protection relay.

	SEC. - PAGE
<b>Thermal overload relays</b>	
For BG series mini-contactors .....	3 - 2
For BF series contactors .....	3 - 4
For B series contactors .....	3 - 8
Accessories .....	3 - 10
<b>Electronic relay</b>	
Thermistor protection relay .....	3 - 11
<b>Dimensions</b> .....	<b>3 - 12</b>
<b>Wiring diagrams</b> .....	<b>3 - 13</b>
<b>Technical characteristics</b> .....	<b>3 - 14</b>

Type of contactor	TYPE OF THERMAL OVERLOAD RELAY				Pages
	Phase failure/single phase sensitive		Non phase failure / non single phase sensitive		
	Manual/hand reset	Automatic reset	Manual/hand reset	Automatic reset	
BG06...BG12	<b>RF9</b>	<b>RFA9</b>	<b>RFN9</b>	<b>RFNA9</b>	3-2 and 3-3
BF09...BF38	<b>RF38</b>		<b>RFN38</b>		3-4...3-6
BF40...BF80❶	<b>RF82</b>	<b>RFA82</b>	<b>RFN82</b>	<b>RFNA82</b>	3-5 and 3-7
BF95...BF110	<b>RF95</b>	<b>RFA95</b>	<b>RFN95</b>	<b>RFNA95</b>	3-4...3-7
B115...B180	<b>RF200</b>		<b>RFN200</b>		3-8 and 3-9
B250...B400	<b>RF400</b>		<b>RFN400</b>		

❶ For BF80 contactors ...A... and ...E... type.

### Phase failure / single phase sensitive Three poles (three phase)

3



11 RF9...



11 RFA9...

Order code	Adjustment range	Protection fuses			Qty per pkg	Wt [kg]
		IEC aM	gG [A]	UL K5 [A]		
	[A]	[A]	[A]	[A]	n°	

#### MANUAL RESETTING.

Direct mounting on BG06, BG09, BG12 mini-contactors.

11 RF9 015	0.09...0.15	0.25	—	—	1	0.116
11 RF9 023	0.14...0.23	0.5	—	1	1	0.116
11 RF9 033	0.2...0.33	0.5	1	1	1	0.116
11 RF9 05	0.3...0.5	1	2	3	1	0.116
11 RF9 075	0.45...0.75	1	2	3	1	0.116
11 RF9 1	0.6...1	2	4	3	5	0.116
11 RF9 1V5	0.9...1.5	2	4	6	5	0.116
11 RF9 2V3	1.4...2.3	4	6	10	5	0.116
11 RF9 33	2...3.3	4	10	10	5	0.116
11 RF9 5	3...5	6	16	15	5	0.116
11 RF9 75	4.5...7.5	8	20	25	5	0.116
11 RF9 10	6...10	10	32	30	5	0.116
11 RF9 15	9...15	16	40	45	5	0.116

#### AUTOMATIC RESETTING.

Direct mounting on BG06, BG09, BG12 mini-contactors.

11 RFA9 015	0.09...0.15	0.25	—	—	1	0.116
11 RFA9 023	0.14...0.23	0.5	—	1	1	0.116
11 RFA9 033	0.2...0.33	0.5	1	1	1	0.116
11 RFA9 05	0.3...0.5	1	2	3	1	0.116
11 RFA9 075	0.45...0.75	1	2	3	1	0.116
11 RFA9 1	0.6...1	2	4	3	1	0.116
11 RFA9 1V5	0.9...1.5	2	4	6	1	0.116
11 RFA9 2V3	1.4...2.3	4	6	10	1	0.116
11 RFA9 33	2...3.3	4	10	10	1	0.116
11 RFA9 5	3...5	6	16	15	1	0.116
11 RFA9 75	4.5...7.5	8	20	25	1	0.116
11 RFA9 10	6...10	10	32	30	1	0.116
11 RFA9 15	9...15	16	40	45	1	0.116

NOTE: Two-pole (single phase) versions are available on request. Add the letter "S" in the order code e.g. 11RF9015 is three pole; 11RFS9015 two pole.

The appropriate adjustment range of the overload relay should be selected on the basis of the motor nameplate full-load current when direct, across the line starting is considered.

#### Three-phase IEC motor powers ①

230V [kW]	400V [kW]	415V [kW]	440V [kW]	500V [kW]	690V [kW]
-----------	-----------	-----------	-----------	-----------	-----------

②	②	②	②	②	②
②	②	②	②	②	②
②	②	②	②	②	②
②	②	②	②	②	②
②	②	②	②	②	0.37
②	②	②	0.37	0.37	0.55
②	②	0.55	0.55	0.55	0.75
0.37	0.55-0.75	0.75	0.75	1.1	1.1-1.5
0.55	1.1	1.1	1.1-1.5	1.5	2.2
0.75-1.1	1.5	1.5-2.2	2.2	2.2	3-3.7
1.5	2.2-3	3-3.7	3-3.7	3-3.7	4
2.2	3.7-4	4	3.7-4	4-5.5	—
3.2	5.5	5.5-7.5	5.5	—	—

②	②	②	②	②	②
②	②	②	②	②	②
②	②	②	②	②	②
②	②	②	②	②	②
②	②	②	②	②	0.37
②	②	②	0.37	0.37	0.55
②	②	0.55	0.55	0.55	0.75
0.37	0.55-0.75	0.75	0.75	1.1	1.1-1.5
0.55	1.1	1.1	1.1-1.5	1.5	2.2
0.75-1.1	1.5	1.5-2.2	2.2	2.2	3-3.7
1.5	2.2-3	3-3.7	3-3.7	3-3.7	4
2.2	3.7-4	4	3.7-4	4-5.5	—
3.2	5.5	5.5-7.5	5.5	—	—

① The indicated powers apply to 4-pole motors; it is advisable to always check that the nameplate motor current is within the relay adjustment range.

② No standard power ratings exist; select relay according to current consumption.

NOTE: To facilitate connection between the auxiliary NC contact of the RF...9 thermal relay and terminal A2 of the contactor, insert the conductor into the appropriate conduit as shown.

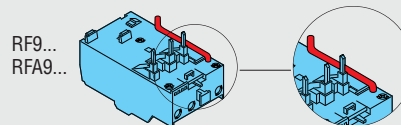

#### Certifications and compliance

Certifications obtained:

Type	cULus	CSA	EAC	CCC
RF9... - RFA9...	●	●	●	●

● Certified products.

cULus – UL Listed for USA and Canada (cULus - File E93601) as Auxiliary Devices – Thermal Overload Relays, 600VAC, open type, ambient compensated, 5000 Amps RMS symmetrical short circuit rating; the trip current is 120% FLA.

CSA – CSA certified for Canada only (File 54332) as Auxiliary Devices for use with magnetic contactors.

Compliant with standards: IEC/EN 60947-1, IEC/EN 60947-4-1, UL508, CSA C22.2 n° 14.

### Non phase failure / non single phase sensitive Three poles (three phase)



11 RFN9...



11 RFNA9...

Order code	Adjustment range	Protection		fuses	Qty	Wt
	[A]	IEC aM	gG [A]	UL K5 [A]	per pkg n°	[kg]

#### MANUAL RESETTING.

Direct mounting on BG06, BG09, BG12 mini-contactors.

11 RFN9 015	0.09...0.15	0.25	—	—	1	0.123
11 RFN9 023	0.14...0.23	0.5	—	1	1	0.123
11 RFN9 033	0.2...0.33	0.5	1	1	1	0.123
11 RFN9 05	0.3...0.5	1	2	3	1	0.123
11 RFN9 075	0.45...0.75	1	2	3	1	0.123
11 RFN9 1	0.6...1	2	4	3	1	0.123
11 RFN9 1V5	0.9...1.5	2	4	6	1	0.123
11 RFN9 2V3	1.4...2.3	4	6	10	1	0.123
11 RFN9 33	2...3.3	4	10	10	1	0.123
11 RFN9 5	3...5	6	16	15	1	0.123
11 RFN9 75	4.5...7.5	8	20	25	1	0.123
11 RFN9 10	6...10	10	32	30	1	0.123
11 RFN9 15	9...15	16	40	45	1	0.123

#### AUTOMATIC RESETTING.

Direct mounting on BG06, BG09, BG12 mini-contactors.

11 RFNA9 015	0.09...0.15	0.25	—	—	1	0.123
11 RFNA9 023	0.14...0.23	0.5	—	1	1	0.123
11 RFNA9 033	0.2...0.33	0.5	1	1	1	0.123
11 RFNA9 05	0.3...0.5	1	2	3	1	0.123
11 RFNA9 075	0.45...0.75	1	2	3	1	0.123
11 RFNA9 1	0.6...1	2	4	3	1	0.123
11 RFNA9 1V5	0.9...1.5	2	4	6	1	0.123
11 RFNA9 2V3	1.4...2.3	4	6	10	1	0.123
11 RFNA9 33	2...3.3	4	10	10	1	0.123
11 RFNA9 5	3...5	6	16	15	1	0.123
11 RFNA9 75	4.5...7.5	8	20	25	1	0.123
11 RFNA9 10	6...10	10	32	30	1	0.123
11 RFNA9 15	9...15	16	40	45	1	0.123

NOTE: The appropriate adjustment range of the overload relay should be selected on the basis of the motor nameplate full-load current when direct, across the line starting is considered.

#### Three-phase IEC motor powers ①

230V	400V	415V	440V	500V	690V
[kW]	[kW]	[kW]	[kW]	[kW]	[kW]

⊗	⊗	⊗	⊗	⊗	⊗
⊗	⊗	⊗	⊗	⊗	⊗
⊗	⊗	⊗	⊗	⊗	⊗
⊗	⊗	⊗	⊗	⊗	⊗
⊗	⊗	⊗	⊗	⊗	0.37
⊗	⊗	⊗	0.37	0.37	0.55
⊗	⊗	0.55	0.55	0.55	0.75
0.37	0.55-0.75	0.75	0.75	1.1	1.1-1.5
0.55	1.1	1.1	1.1-1.5	1.5	2.2
0.75-1.1	1.5	1.5-2.2	2.2	2.2	3-3.7
1.5	2.2-3	3-3.7	3-3.7	3-3.7	4
2.2	3.7-4	4	3.7-4	4-5.5	—
3.2	5.5	5.5-7.5	5.5	—	—

⊗	⊗	⊗	⊗	⊗	⊗
⊗	⊗	⊗	⊗	⊗	⊗
⊗	⊗	⊗	⊗	⊗	⊗
⊗	⊗	⊗	⊗	⊗	⊗
⊗	⊗	⊗	⊗	⊗	0.37
⊗	⊗	⊗	0.37	0.37	0.55
⊗	⊗	0.55	0.55	0.55	0.75
0.37	0.55-0.75	0.75	0.75	1.1	1.1-1.5
0.55	1.1	1.1	1.1-1.5	1.5	2.2
0.75-1.1	1.5	1.5-2.2	2.2	2.2	3-3.7
1.5	2.2-3	3-3.7	3-3.7	3-3.7	4
2.2	3.7-4	4	3.7-4	4-5.5	—
3.2	5.5	5.5-7.5	5.5	—	—

① The indicated powers apply to 4-pole motors; it is advisable to always check that the nameplate motor current is within the relay adjustment range.

⊗ No standard power ratings exist; select relay according to current consumption.

NOTE: To facilitate connection between the auxiliary NC contact of the RFN...9 thermal relay and terminal A2 of the contactor, insert the conductor into the appropriate conduit as shown.

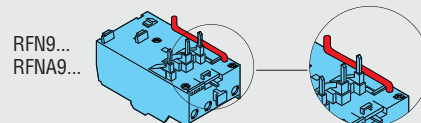

#### Certifications and compliance

Certifications obtained:

Type	cULus	CSA	EAC	CCC
RFN9... - RFNA9...	●	●	●	●

● Certified products.

cULus – UL Listed for USA and Canada (cULus - File E93601) as Auxiliary Devices – Thermal Overload Relays, 600VAC, open type, ambient compensated, 5000 Amps RMS symmetrical short circuit rating; the trip current is 120% FLA.

CSA – CSA certified for Canada only (File 54332) as Auxiliary Devices for use with magnetic contactors.

Compliant with standards: IEC/EN 60947-1, IEC/EN 60947-4-1, UL508, CSA C22.2 n° 14.

### Phase failure / single phase sensitive Three poles (three phase)

3



RF38...

Order code	Adjustment range	Protection fuses			Qty per pkg	Wt [kg]
		IEC aM	gG [A]	UL 1 [A]		
	[A]	[A]	[A]	[A]	n°	

MANUAL OR AUTOMATIC RESETTING.

Direct mounting on BF09...BF38 contactors.

Independent mounting with RFX38 04 base.

RF38 0016	0.1...0.16	0.25	—	1	1	0.160
RF38 0025	0.16...0.25	0.5	—	1	1	0.160
RF38 0040	0.25...0.4	0.5	1	3	1	0.160
RF38 0063	0.4...0.63	1	2	3	1	0.160
RF38 0100	0.63...1	2	4	3	5	0.160
RF38 0160	1...1.6	2	4	6	5	0.160
RF38 0250	1.6...2.5	4	6	10	5	0.160
RF38 0400	2.5...4	4	6	15	5	0.160
RF38 0650	4...6.5	8	16	25	5	0.160
RF38 1000	6.3...10	10	20	40	5	0.160
RF38 1400	9...14	16	32	50	5	0.160
RF38 1800	13...18	25	40	70	5	0.160
RF38 2300	17...23	25	50	90	5	0.160
RF38 2500	20...25	32	50	100	5	0.160
RF38 3200	24...32	40	63	120	1	0.160
RF38 3800	32...38	40	63	150	1	0.160

1 UL RK5 fuse class for RF38 types and UL K5 fuse class for RF...95 types.

NOTE: Two pole (single phase) versions are available on request.

Add the letter "S" in the order code e.g. RF381000 is three pole; RFS381000 two pole.

The appropriate adjustment range of the overload relay should be selected on the basis of the motor nameplate full-load current when direct, across the line starting is considered.

### Three-phase IEC motor powers ②

230V	400V	415V	440V	500V	690V
[kW]	[kW]	[kW]	[kW]	[kW]	[kW]

②	②	②	②	②	0.06
②	0.06	0.06	0.06-0.09	0.06-0.09	0.09-0.12
0.06	0.09	0.09	0.12	0.12	0.18
0.09	0.12-0.18	0.12-0.18	0.18	0.18	0.25
0.12	0.25	0.25	0.37	0.25-0.37	0.37-0.55
0.18-0.25	0.37-0.55	0.37-0.55	0.55	0.55-0.75	0.75
0.37	0.75	0.75	0.75-1.1	1.1	1.1-1.5
0.55-0.75	1.1-1.5	1.1-1.5	1.1	1.5-2.2	2.2-3
1.1-1.5	2.2	2.2	2.2-3	3	4
1.5-2.2	3-4	4	4	4-5.5	5.5-7.5
3	5.5	5.5	5.5-7.5	5.5-7.5	11
4	7.5	7.5-9	9	11	15
5.5	11	9-11	11	11	18.5
5.5	11	11	11	15	22
7.5	15	15	15	18.5	30
11	18.5	18.5	18.5	22	30

② No standard powers ratings exist; select relay according to current consumption.

③ The indicated powers apply to 4-pole motors; it is advisable to always check that the nameplate motor current is within the relay adjustment range.

### Certifications and compliance

Certifications obtained:

Typo	cULus	CSA	EAC	CCC	Register of shipping
RF38	●	—	●	●	—

● Certified products.

cULus – UL Listed for USA and Canada (cULus - File E93601) as Auxiliary Devices – Thermal Overload Relays, 600VAC, open type, ambient compensated, 5000 Amps RMS symmetrical short circuit rating up to 82A FLA range and 10000 Amps RMS for 95A and 110A FLA range; the trip current is 120% FLA. CSA – CSA certified for Canada only (File 54332) as Auxiliary Devices for use with magnetic contactors.

Compliant with standards: IEC/EN 60947-1, IEC/EN 60947-4-1, UL508, CSA C22.2 n° 14.

### FIXING EASE OF THE THERMAL OVERLOAD RELAY

While the thermal overload relay is being linked to the contactor, its auxiliary contact fits on and connects to the coil terminal by rigid terminal.

Complete relay fixing is done in a single operation, with no need of other connections.

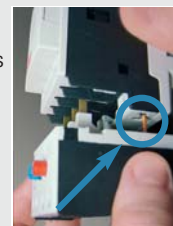

### Phase failure / single phase sensitive Three poles (three phase)



RF82



11 RF95 3...



RFA82



11 RFA95 3...

Order code	Adjustment range	Protection IEC aM	fuses gG	UL fuses	Qty per pkg	Wt [kg]
	[A]	[A]	[A]	[A]	n°	[kg]

MANUAL RESETTING.  
Direct mounting on BF40...BF80 contactors (BF80 ...A... and ...E... type).  
Complete with G261 links.  
Independent mounting with G270 base.

<b>RF82 3300</b>	20...33	40	63	110	1	0.365
<b>RF82 4200</b>	28...42	50	80	150	1	0.365
<b>RF82 5000</b>	35...50	50	100	175	1	0.365
<b>RF82 6500</b>	46...65	80	125	200	1	0.365
<b>RF82 8200</b>	60...82	100	200	250	1	0.365

MANUAL RESETTING.  
Direct mounting on BF95...BF110 contactors.  
Complete with G261 links.  
Independent mounting with G270 base.

<b>11 RF95 3 82</b>	60...82	100	200	250	1	0.365
<b>11 RF95 3 95</b>	70...95	100	200	350	1	0.365
<b>11 RF95 3 110</b>	90...110	125	200	350	1	0.365

AUTOMATIC RESETTING.  
Direct mounting on BF40...BF80 contactors (BF80 ...A... and ...E... type).  
Complete with G261 links.  
Independent mounting with G270 base.

<b>RFA82 3300</b>	20...33	40	63	110	1	0.365
<b>RFA82 4200</b>	28...42	50	80	150	1	0.365
<b>RFA82 5000</b>	35...50	50	100	175	1	0.365
<b>RFA82 6500</b>	46...65	80	125	200	1	0.365
<b>RFA82 8200</b>	60...82	100	200	250	1	0.365

AUTOMATIC RESETTING.  
Direct mounting on BF95...BF110 contactors.  
Complete with G261 links.  
Independent mounting with G270 base.

<b>11 RFA95 3 82</b>	60...82	100	200	250	1	0.365
<b>11 RFA95 3 95</b>	70...95	100	200	350	1	0.365
<b>11 RFA95 3 110</b>	90...110	125	200	350	1	0.365

① UL RK5 fuse class for RF38 types and UL K5 fuse class for RF...95 types.

NOTE: Two pole (single phase) versions are available on request.  
Add the letter "S" in the order code e.g. RF828200 is three pole; RFS828200 two pole.

The appropriate adjustment range of the overload relay should be selected on the basis of the motor nameplate full-load current when direct, across the line starting is considered.

### Three-phase IEC motor powers ②

230V [kW]	400V [kW]	415V [kW]	440V [kW]	500V [kW]	690V [kW]
-----------	-----------	-----------	-----------	-----------	-----------

7.5	11-15	11-15	15-18.5	15-18.5	22-25
9-10	15-18.5	18.5-22	18.5-22	22-25	30-33
10-11	22	25	25	30	37-40
15-18.5	25-30	30-33	30-33	33-40	45-55
22	33-40	37-45	37-45	45-55	59-75

22	33-40	37-45	37-45	45-55	59-75
22-25	40-45	45-51	45-55	55-63	75-80
30	55	55	55	75	90

7.5	11-15	11-15	15-18.5	15-18.5	22-25
9-10	15-18.5	18.5-22	18.5-22	22-25	30-33
10-11	22	25	25	30	37-40
15-18.5	25-30	30-33	30-33	33-40	45-55
22	33-40	37-45	37-45	45-55	59-75

22	33-40	37-45	37-45	45-55	59-75
22-25	40-45	45-51	45-55	55-63	75-80
30	55	55	55	75	90

② The indicated powers apply to 4-pole motors; it is advisable to always check that the nameplate motor current is within the relay adjustment range.

### Certifications and compliance

Certifications obtained:

Typo	cULus	CSA	EEC	CCC	Register of shipping
RF82	●	—	●	●	—
RFNA82	●	—	●	●	—
RF95	●	●	●	●	●
RFA95	●	●	●	●	—

● Certified products.

cULus – UL Listed for USA and Canada (cULus - File E93601) as Auxiliary Devices – Thermal Overload Relays, 600VAC, open type, ambient compensated, 5000 Amps RMS symmetrical short circuit rating up to 82A FLA range and 10000 Amps RMS for 95A and 110A FLA range; the trip current is 120% FLA.  
CSA – CSA certified for Canada only (File 54332) as Auxiliary Devices for use with magnetic contactors.

Compliant with standards: IEC/EN 60947-1, IEC/EN 60947-4-1, UL508, CSA C22.2 n° 14.

### FIXING EASE OF THE THERMAL OVERLOAD RELAY

While the thermal overload relay is being linked to the contactor, its auxiliary contact fits on and connects to the coil terminal by rigid terminal. Complete relay fixing is done in a single operation, with no need of other connections.

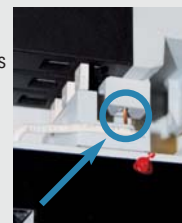



# Motor protection relays

## Thermal overload relays for BF series contactors

**Non phase failure / non single phase sensitive**  
**Three poles (three phase)**

3



RFN38...

Order code	Adjustment range	Protection fuses		Qty per pkg	Wt [kg]
		IEC aM	gG		
	[A]	[A]	[A]	n°	

MANUAL OR AUTOMATIC RESETTING.  
Direct mounting on BF09...BF38 contactors.  
Independent mounting with RFX38 04 base.

Order code	Adjustment range	Protection fuses IEC aM	Protection fuses gG	Qty per pkg	Wt [kg]
RFN38 0016	0.1...0.16	0.25	—	1	0.160
RFN38 0025	0.16...0.25	0.5	—	1	0.160
RFN38 0040	0.25...0.4	0.5	1	3	0.160
RFN38 0063	0.4...0.63	1	2	3	0.160
RFN38 0100	0.63...1	2	4	3	0.160
RFN38 0160	1...1.6	2	4	6	0.160
RFN38 0250	1.6...2.5	4	6	10	0.160
RFN38 0400	2.5...4	4	6	15	0.160
RFN38 0650	4...6.5	8	16	25	0.160
RFN38 1000	6.3...10	10	20	40	0.160
RFN38 1400	9...14	16	32	50	0.160
RFN38 1800	13...18	25	40	70	0.160
RFN38 2300	17...23	25	50	90	0.160
RFN38 2500	20...25	32	50	100	0.160
RFN38 3200	24...32	40	63	125	0.160
RFN38 3800	32...38	40	63	150	0.160

① UL RK5 fuse class for RFN38 types and UL K5 fuse class for RF...95 types.

NOTE: The appropriate adjustment range of the overload relay should be selected on the basis of the motor nameplate full-load current when direct, across the line starting is considered.

### Three-phase IEC motor powers ②

230V [kW]	400V [kW]	415V [kW]	440V [kW]	550V [kW]	690V [kW]
-----------	-----------	-----------	-----------	-----------	-----------

②	②	②	②	②	0.06
②	0.06	0.06	0.06-0.09	0.06-0.09	0.09-0.12
0.06	0.09	0.09	0.12	0.12	0.18
0.09	0.12-0.18	0.12-0.18	0.18	0.18	0.25
0.12	0.25	0.25	0.37	0.25-0.37	0.37-0.55
0.18-0.25	0.37-0.55	0.37-0.55	0.55	0.55-0.75	0.75
0.37	0.75	0.75	0.75-1.1	1.1	1.1-1.5
0.55-0.75	1.1-1.5	1.1-1.5	1.1	1.5-2.2	2.2-3
1.1-1.5	2.2	2.2	2.2-3	3	4
1.5-2.2	3-4	4	4	4-5.5	5.5-7.5
3	5.5	5.5	5.5-7.5	5.5-7.5	11
4	7.5	7.5-9	9	11	15
5.5	11	9-11	11	11	18.5
5.5	11	11	11	15	22
7.5	15	15	15	18.5	30
11	18.5	18.5	18.5	22	30

② No standard power ratings exist; select relay according to current consumption.

③ The indicated powers apply to 4-pole motors; it is advisable to always check that the nameplate motor current is within the relay adjustment range.

### Certifications and compliance

Certifications obtained:

Type	cULus	CSA	EAC	CCC
RFN38	●	—	●	●

● Certified products.

cULus – UL Listed for USA and Canada (cULus - File E93601) as Auxiliary Devices – Thermal Overload Relays, 600VAC, open type, ambient compensated, 5000 Amps RMS symmetrical short circuit rating up to 82A FLA range and 10000 Amps RMS for 95A and 110A FLA range; the trip current is 120% FLA.  
CSA – CSA certified for Canada only (File 54332) as Auxiliary Devices for use with magnetic contactors.

Compliant with standards: IEC/EN 60947-1, IEC/EN 60947-4-1, UL508, CSA C22.2 n° 14.

### Non phase failure / non single phase sensitive Three poles (three phase)



RFN82



11 RFN95 3...



RFNA82



11 RFNA95 3...

Order code	Adjustment range	Protection fuses UL			Qty per pkg	Wt [kg]
		IEC aM	gG	UL ①		
	[A]	[A]	[A]	[A]	n°	

**MANUAL RESETTING.**  
Direct mounting on BF40...BF80 contactors (BF80 ...A... and ...E... type).  
Complete with G261 links.  
Independent mounting with G270 base.

<b>RFN82 4200</b>	28...42	50	80	150	1	0.365
<b>RFN82 5000</b>	35...50	50	100	175	1	0.365
<b>RFN82 6500</b>	46...65	80	125	200	1	0.365
<b>RFN82 8200</b>	60...82	100	200	250	1	0.365

**MANUAL RESETTING.**  
Direct mounting on BF95...BF110 contactors.  
Complete with G261 links.  
Independent mounting with G270 base.

<b>11 RFN95 3 82</b>	60...82	100	200	250	1	0.365
<b>11 RFN95 3 95</b>	70...95	100	200	350	1	0.365
<b>11 RFN95 3 110</b>	90...110	125	200	350	1	0.365

**AUTOMATIC RESETTING.**  
Direct mounting on BF40...BF80 contactors (BF80 ...A... and ...E... type).  
Complete with G261 links.  
Independent mounting with G270 base.

<b>RFNA82 4200</b>	28...42	50	80	150	1	0.365
<b>RFNA82 5000</b>	35...50	50	100	175	1	0.365
<b>RFNA82 6500</b>	46...65	80	125	200	1	0.365
<b>RFNA82 8200</b>	60...82	100	200	250	1	0.365

**AUTOMATIC RESETTING.**  
Direct mounting on BF95...BF110 contactors.  
Complete with G261 links.  
Independent mounting with G270 base.

<b>11 RFNA95 3 82</b>	60...82	100	200	250	1	0.365
<b>11 RFNA95 3 95</b>	70...95	100	200	350	1	0.365
<b>11 RFNA95 3 110</b>	90...110	125	200	350	1	0.365

① UL RK5 fuse class for RFN82 types and UL K5 fuse class for RF...95 types.

NOTE: The appropriate adjustment range of the overload relay should be selected on the basis of the motor nameplate full-load current when direct, across the line starting is considered.

### Three-phase IEC motor powers ②

230V [kW]	400V [kW]	415V [kW]	440V [kW]	550V [kW]	690V [kW]
-----------	-----------	-----------	-----------	-----------	-----------

9-10	15-18.5	18.5-22	18.5-22	22-25	30-33
10-11	22	25	25	30	37-40
15-18.5	25-30	30-33	30-33	33-40	45-55
22	33-40	37-45	37-45	45-55	59-75

22	33-40	37-45	37-45	45-55	59-75
22-25	40-45	45-51	45-55	55-63	75-80
30	55	55	55	75	90

9-10	15-18.5	18.5-22	18.5-22	22-25	30-33
10-11	22	25	25	30	37-40
15-18.5	25-30	30-33	30-33	33-40	45-55
22	33-40	37-45	37-45	45-55	59-75

22	33-40	37-45	37-45	45-55	59-75
22-25	40-45	45-51	45-55	55-63	75-80
30	55	55	55	75	90

② The indicated powers apply to 4-pole motors; it is advisable to always check that the nameplate motor current is within the relay adjustment range.

### Certifications and compliance

Certifications obtained:

Type	cULus	CSA	EAC	CCC
RFN82	●	—	●	●
RFNA82	●	—	●	●
RFN95	●	●	●	●
RFNA95	●	●	●	●

● Certified products.

cULus – UL Listed for USA and Canada (cULus - File E93601) as Auxiliary Devices – Thermal Overload Relays, 600VAC, open type, ambient compensated, 5000 Amps RMS symmetrical short circuit rating up to 82A FLA range and 10000 Amps RMS for 95A and 110A FLA range; the trip current is 120% FLA.  
CSA – CSA certified for Canada only (File 54332) as Auxiliary Devices for use with magnetic contactors.

Compliant with standards: IEC/EN 60947-1, IEC/EN 60947-4-1, UL508, CSA C22.2 n° 14.

### FIXING EASE OF THE THERMAL OVERLOAD RELAY

While the thermal overload relay is being linked to the contactor, its auxiliary contact fits on and connects to the coil terminal by rigid terminal. Complete relay fixing is done in a single operation, with no need of other connections.

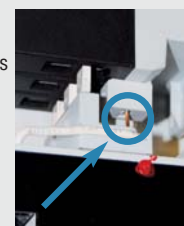



### Phase failure / single phase sensitive Three poles (three phase)

3



RF200... - RF420...

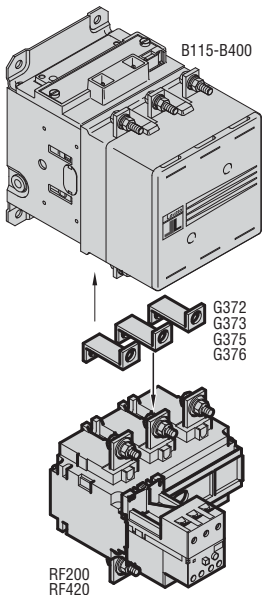

Order code	Adjustment range	Protection fuses			Qty per pkg	Wt [kg]
		IEC aM	gG [A]	UL K5 [A]		
	[A]	[A]	[A]	[A]	n°	

#### MANUAL OR AUTOMATIC RESETTING.

Independent screw fixing or direct mounting on contactors:  
B115-B145-B180 using G372 links.  
B250-B310-B400 using G373 links.

<b>RF200 100</b>	60...100	100	160	500	1	2.150
<b>RF200 125</b>	75...125	125	200	500	1	2.150
<b>RF200 150</b>	90...150	160	250	500	1	2.150
<b>RF200 200</b>	120...200	200	315	500	1	2.150

Independent screw fixing or direct mounting on contactors:  
B145-B180 using G375 links  
B250-B310-B400 using G376 links

<b>RF420 250</b>	150...250	250	400	800	1	2.460
<b>RF420 300</b>	180...300	315	500	800	1	2.460
<b>RF420 420</b>	250...420	500	630	800	1	2.460

NOTE: The appropriate adjustment range of the overload relay should be selected on the basis of the motor nameplate full-load current when direct, across the line starting is considered.

#### RELAYS FOR B500 AND B630 CONTACTORS

##### MANUAL OR AUTOMATIC RESETTING.

Consult Customer Service for the relative order codes and detailed information; see contact details on inside front cover.

#### Three-phase IEC motor powers

230V [kW]	400V [kW]	415V [kW]	440V [kW]	550V [kW]	690V [kW]
-----------	-----------	-----------	-----------	-----------	-----------

18.5-25	33-51	37-55	37-59	45-63	59-92
22-37	40-63	45-63	51-75	55-80	75-110
25-45	51-80	55-80	55-92	63-100	92-140
37-59	75-100	75-100	75-110	92-140	129-184

45-75	92-132	92-147	100-150	110-162	140-220
55-92	100-162	110-162	129-184	129-198	180-280
75-110	129-198	147-220	150-220	180-280	250-368

NOTE: For 1000V powers, consult Customer Service for information; see contact details on inside front cover.

ⓘ The indicated powers apply to 4-pole motors; it is advisable to always check that the nameplate motor current is within the relay adjustment range.

#### Certifications and compliance

Certifications obtained:

Type	C U L U S	E A C
RF200	●	●
RF420	●	●

● Certified products.

cULus – UL Listed for USA and Canada (cULus - File E93601) as Auxiliary Devices – Thermal Overload Relays, 600VAC, open type, ambient compensated, 5000 Amps RMS symmetrical short circuit rating up to 150A FLA range, 10000 Amps RMS for 200A up to 300A FLA range and 18000 Amps for the 420A; the trip current is 120% FLA.

Compliant with standards: IEC/EN 60947-1, IEC/EN 60947-4-1, UL508, CSA C22.2 n° 14.

# Motor protection relays

## Thermal overload relays for B series contactors

**Non phase failure / non single phase sensitive  
Three poles (three phase)**



RFN200... - RFN420...

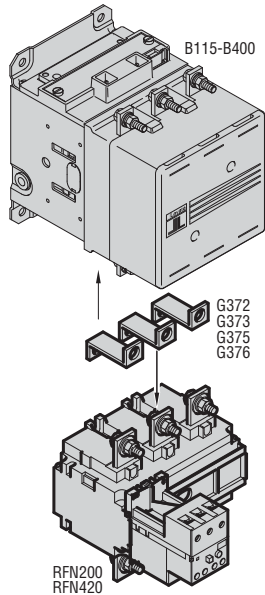

Order code	Adjustment range	Protection fuses			Qty per pkg	Wt [kg]
		IEC aM [A]	gG [A]	UL K5 [A]		
	[A]	[A]	[A]	[A]	n°	

MANUAL OR AUTOMATIC RESETTING.  
Independent screw fixing or direct mounting on contactors:  
B115-B145-B180 using G372 links.  
B250-B310-B400 using G373 links.

<b>RFN200 100</b>	60...100	100	160	500	1	2.150
<b>RFN200 125</b>	75...125	125	200	500	1	2.150
<b>RFN200 150</b>	90...150	160	250	500	1	2.150
<b>RFN200 200</b>	120...200	200	315	500	1	2.150

Independent screw fixing or direct mounting on contactors:  
B145-B180 using G375 links.  
B250-B310-B400 using G376 links.

<b>RFN420 250</b>	150...250	250	400	800	1	2.460
<b>RFN420 300</b>	180...300	315	500	800	1	2.460
<b>RFN420 420</b>	250...420	500	630	800	1	2.460

NOTE: The appropriate adjustment range of the overload relay should be selected on the basis of the motor nameplate full-load current when direct, across the line starting is considered.

### RELAYS FOR B500 AND B630 CONTACTORS.

MANUAL OR AUTOMATIC RESETTING.  
Consult Customer Service for the relative order codes and detailed information; see contact details on inside front cover.

### Three-phase IEC motor powers

230V [kW]	400V [kW]	415V [kW]	440V [kW]	550V [kW]	690V [kW]
-----------	-----------	-----------	-----------	-----------	-----------

18.5-25	33-51	37-55	37-59	45-63	59-92
22-37	40-63	45-63	51-75	55-80	75-110
25-45	51-80	55-80	55-92	63-100	92-140
37-59	75-100	75-100	75-110	92-140	129-184

45-75	92-132	92-147	100-150	110-162	140-220
55-92	100-162	110-162	129-184	129-198	180-280
75-110	129-198	147-220	150-220	180-280	250-368

NOTE: For 1000V powers, consult Customer Service for information; see contact details on inside front cover.

ⓘ The indicated powers apply to 4-pole motors; it is advisable to always check that the nameplate motor current is within the relay adjustment range.

### Certifications and compliance

Certifications obtained:

Type	C U L u s	E A C
RFN200	●	●
RFN420	●	●

● Certified products.

cULus – UL Listed for USA and Canada (cULus - File E93601) as Auxiliary Devices – Thermal Overload Relays, 600VAC, open type, ambient compensated, 5000 Amps RMS symmetrical short circuit rating up to 150A FLA range, 10000 Amps RMS for 200A up to 300A FLA range and 18000 Amps for the 420A; the trip current is 120% FLA.

Compliant with standards: IEC/EN 60947-1, IEC/EN 60947-4-1, UL508, CSA C22.2 n° 14.

3



RFX38 02



RFX38 03



11 G262



RFX38 04



11 G228



11 G244

Order code	For relay	Qty per pkg	Wt
		n°	[kg]

Set of links for direct contactor mounting.

11 G372	RF...200 on contactor	B115-B145-B180	1	0.250
11 G373		B250-B310-B400	1	0.360
11 G375	RF...420 on contactor	B145-B180	1	0.313
11 G376		B250-B310-B400	1	0.500

Protection cover for thermal overload relay-contactor assembly.

RFX38 02	RF38 on contactor BF09-BF12-BF18-BF25	10	0.014
RFX38 03	RF38 on contactor BF26-BF32-BF38	10	0.014

Protection shrouds for power terminals.

11 G262	RF...95...3	10	0.003
11 G361	RF...200	6	0.026
11 G363	RF...420	6	0.046

Independent mounting.  
Screw fixing or 35mm DIN rail (IEC/EN 60715) mounting.

RFX38 04	RF...38	5	0.082
11 G270	RF...82 - RF...95	10	0.148

Electrical reset.

11 G228	RF...9 - RF...82 - RF...95	5	0.072
---------	----------------------------	---	-------

Sealing device.

RFX38 01	RF...38 - RF...200 - RF...420	10	0.002
11 G233	RF...9 - RF...82 - RF...95	1	0.006

Electric button NO.

11 G244	RF...9 - RF...82 - RF...95	10	0.011
---------	----------------------------	----	-------

Marking element.

11 RB6	RF...9 - RF...82 - RF...95	100	0.003
--------	----------------------------	-----	-------

Set of 100 alphanumeric symbol.

3958	RF...9 - RF...82 - RF...95	1	0.002
------	----------------------------	---	-------

- Front IP20 protection is warranted to contactor-thermal relay connections.
- Independent mounting base for any RF95 relay. Remove the links fixed on RF...95 and use those supplied with the base.
- Replace with voltage digit. Standard voltages are:  
- AC 50/60Hz 24V / 48V / 110-125V / 220-240V / 380-415V.
- Replace with the required alphanumeric symbol. Each package contains 100 pieces of the same symbol.

### Operational characteristics

#### ELECTRICAL RESET G228

Control circuit voltage AC (50/60Hz)	V	12...550
Power consumption in AC	VA	300
Minimum reset time	ms	20
Terminals	Faston	6.3x0.8

NOTE: Coils can remain supplied for a maximum interval of 500ms; 3 consecutive operations are allowed, followed by a 5 minute interval. Reset only if at least 1min has passed from overload tripping.  
It is recommended to use the wiring diagram on page 3-13.

#### INDEPENDENT MOUNTING

- Conductor cross section with one cable:

- 6...10mm<sup>2</sup> / AWG 8 for RFX38 04
- 35mm<sup>2</sup> / AWG 2 for G270

- Tightening torque:

- 2...2.5Nm / 1.5...1.8lbf for RFX38 04
- 3.9Nm / 2.88lbf for G270.

#### Certifications and compliance

Certifications obtained:

Typo	cULus	CSA	EAC
G361	—	●	●
G363	—	●	●
G372	—	●	●
G373	—	●	●
G375	—	●	●
G376	—	●	●
G270	●	—	●
RFX38 04	●	—	●

● Certified products.

cULus – UL Listed for USA and Canada (cULus - File E93601) as Auxiliary Devices for thermal overload relays.  
CSA – CSA certified for Canada only (File 54332) as Kits for industrial control equipment.

Compliant with standards: IEC/EN 60947-1, IEC/EN 60947-4-1, UL508, CSA C22.2 n° 14.

### Combinations

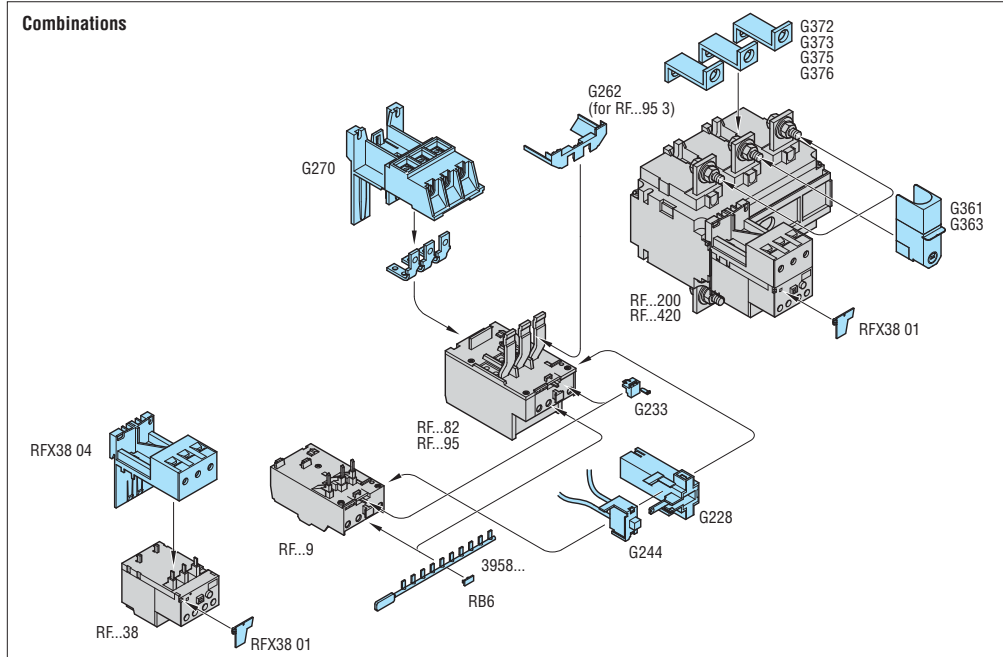

#### Protection cover for thermal overload relay-contactor assembly

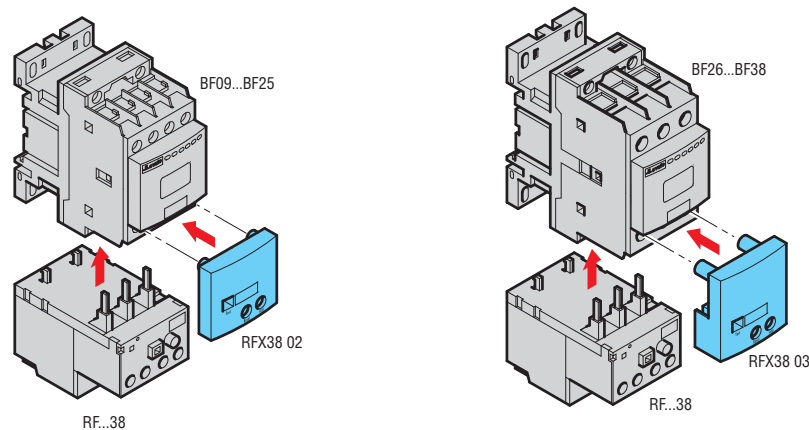

### Thermistor protection relay



31 DRPT...

Order code	Rated auxiliary supply voltage	Qty per pkg	Wt.
	[V]	n°	[kg]
DC supply (version for 35mm DIN rail IEC/EN 60715).			
<b>31 DRPTC 24</b>	24VDC	1	0.269
AC supply (version for 35mm DIN rail IEC/EN 60715).			
<b>31 DRPT 24</b>	24VAC	1	0.269
<b>31 DRPT 110</b>	110VAC	1	0.269
<b>31 DRPT 220</b>	220...240VAC	1	0.269
Accessories.			
Order code	Description	Qty per pkg	Wt.
		n°	[kg]
<b>31 CE106</b>	Adapter for screw fixing of DRPT relay on mounting plate.	10	0.008

① Galvanic isolation between supply and measuring circuits does not exist.

#### General characteristics

The DRPT is a thermal protection relay for motors equipped with thermistor PTC sensors immersed in the winding heads. The maximum number of thermistors to be used is limited by the resistance of all the sensors connected in series; total ohmic value is not to exceed 1.5kΩ at 25°C.

The DRPT type has fail-safe operation: the protective feature trips even in the case the PTC circuit is disconnected or there is a lack of voltage. Resetting is manual or automatic.

#### Operational characteristics

- Supply circuit
  - Rated frequency: 50-60Hz for AC types only
  - Operational limits: 0.85...1.1 Us
  - Maximum dissipation: 2.5W
  - Connection: permanent
- Measuring circuit
  - Type of connectable PTC sensor: According to DIN 44081
  - Total PTC resistance at 25°C: ≤1.5kΩ
  - Tripping resistance: 2.7...3.1kΩ
  - Resetting resistance: 1.5...1.8kΩ
  - Voltage at PTC terminals: ≤ 2.5VDC
- Remote resetting
  - Control: NC contact opening
  - Contact voltage: 5VDC
  - Current consumption: about 1mA
- Relay output
  - Arrangement: 1 relay with 2 changeover contacts
  - Rated operational voltage Ue: 250VAC
  - Conventional free air thermal current Ith: 5A
  - Designation to IEC/EN 60947-5-1: B300
  - Mechanical life: 50x10<sup>6</sup> cycles
  - Electrical life (with rated load): 2x10<sup>5</sup> cycles
- Indications
  - Green LED indicator for power ON
  - Red LED indicator for relay state TRIP
- Connections
  - Conductor section 2x1.5mm<sup>2</sup> with ferrule (max)
  - Tightening torque: 0.8-1.2Nm
- Ambient conditions
  - Operating temperature: -10...+60°C
  - Storage temperature: -30...+80°C
- Housing
  - Snap on 35mm DIN rail (IEC/EN 60715)
  - For screw fixing, use CE106 adapter
  - Degree of protection
    - IP40 housing
    - IP20 terminals.

#### Certifications and compliance

Certifications obtained: EAC.  
Compliant with standards: IEC/EN 60255-5.

### ACCESSORIES FOR THERMAL OVERLOAD RELAYS

#### RFX38 04 base c/w RF...38 thermal relay

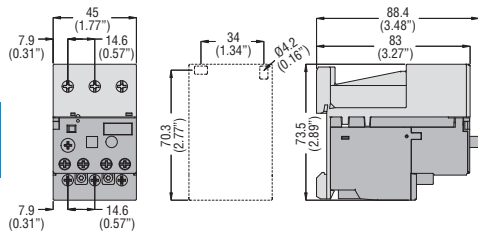

#### G270 base c/w RF...82 and RF...95 thermal relay

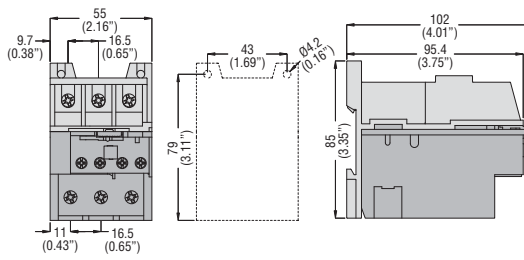

### THERMAL RELAYS WITH LINKS

#### RF...200 with G372 and G373

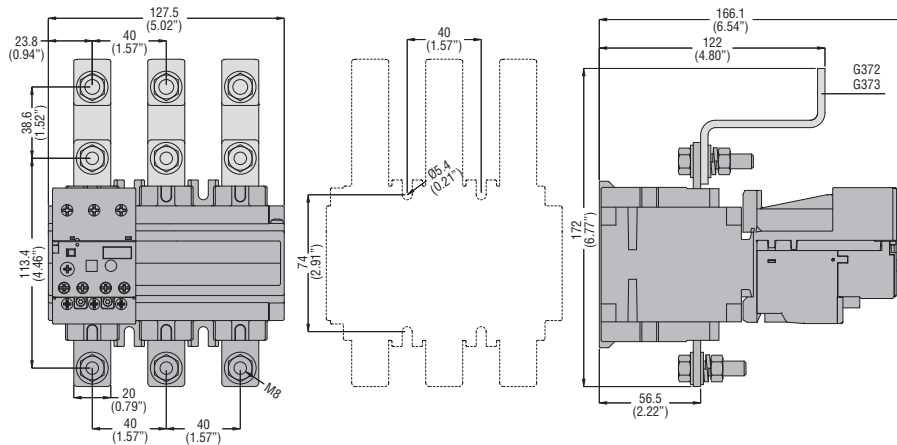

#### RF...420 with G375 and G376

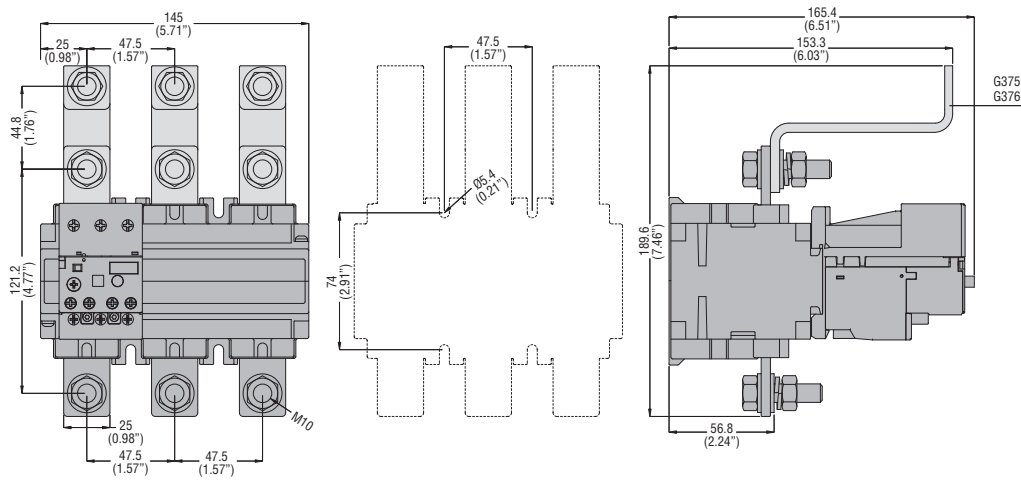

### ADD-ON BLOCKS FOR THERMAL OVERLOAD RELAYS RF...9, RF...82 and RF...95

#### G228... reset

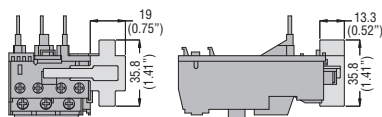

#### G244 button

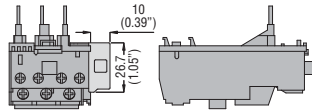

### THERMISTOR PROTECTION RELAY

#### DRPT

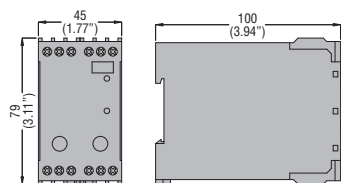

#### CE106 adapter

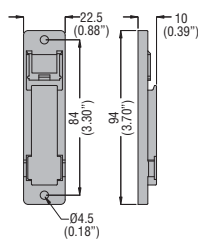

### THERMAL OVERLOAD RELAYS FOR BG MINI-CONTACTORS

#### RF9 - RFN9

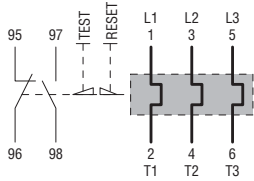

#### RFA9 - RFNA9

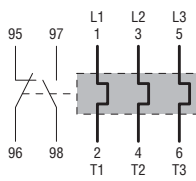

### THERMAL OVERLOAD RELAYS FOR BF CONTACTORS

#### RF38 - RFN38

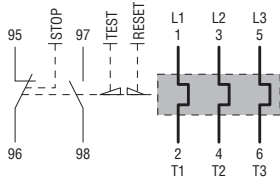

#### RF82 - RFN82 - RF95 - RFN95

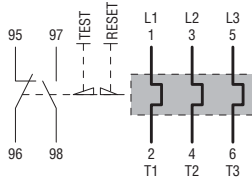

#### RFA82 - RFNA82 - RFA95 - RFNA95

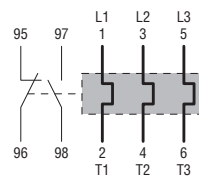

### THERMAL OVERLOAD RELAYS FOR B CONTACTORS

#### RF200 - RFN200

#### RF420 - RFN420

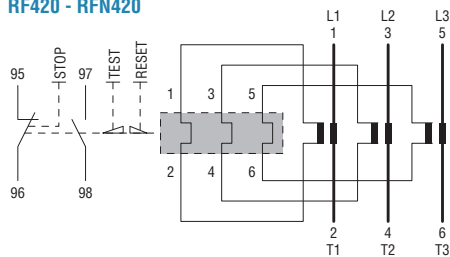

### ADD-ON BLOCKS FOR THERMAL OVERLOAD RELAYS RF9 - RF95

#### Electric reset G228

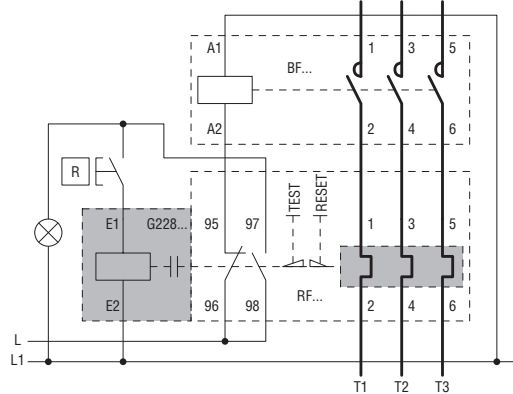

### THERMISTOR PROTECTION RELAY

#### DRPT

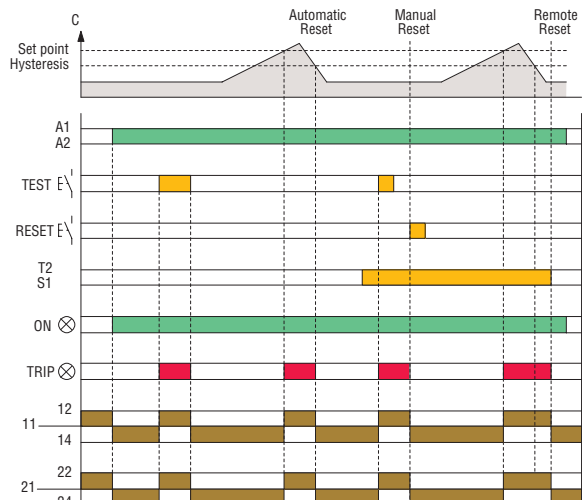
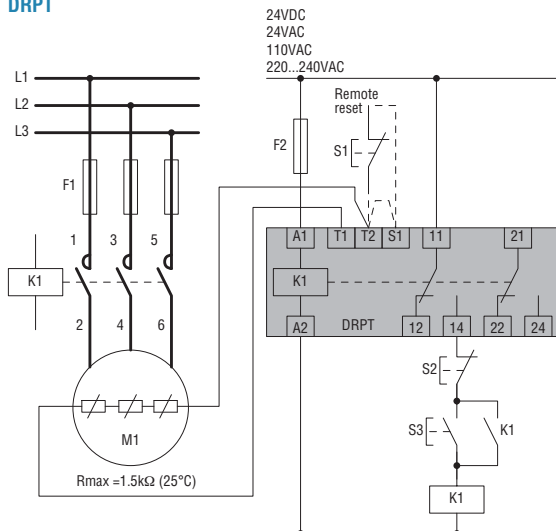



Phase failure/single phase sensitive manual reset	<b>RF9</b>	<b>RF38<sup>①</sup></b>	<b>RF82</b>	<b>RF95</b>	<b>RF200<sup>①</sup></b>	<b>RF420<sup>①</sup></b>
Phase failure sensitive automatic reset	<b>RFA9</b>	<b>RFN38<sup>①</sup></b>	<b>RFA82</b>	<b>RFA95</b>	<b>RFN200<sup>①</sup></b>	<b>RFN420<sup>①</sup></b>
Non phase failure/non single phase sensitive manual reset	<b>RFN9</b>		<b>RFN82</b>	<b>RFN95</b>		
Non phase failure/non single phase sensitive automatic reset	<b>RFNA9</b>		<b>RFNA82</b>	<b>RFNA95</b>		

### POWER CIRCUIT CHARACTERISTICS

IEC rated insulation voltage $U_i$	V	690	690	690	690	1000	1000
IEC rated impulse withstand voltage $U_{imp}$	kV	8	6	8	8	6	6
Frequency limit	Hz	0...400	0...400	0...400	0...400	50...60	50...60
Operational range	from	A	0.09	0.1	14	14	60
	to	A	15	38	82	110	200
Tripping class		10A					
Particular characteristics		Test button - Trip indicator					
Connection		Direct				With current transformers <sup>②</sup>	
Terminals	Type	Screw and washer		Yoke clamp		Screw and flat washer	
	Screw	M4	M4	M5	M5	M8	M10
	Terminal width	mm	9.8	12.6	9	9	20
Phillips	n°	2	2	2	2	13mm <sup>④</sup>	18mm <sup>④</sup>
	Nm	2.3	2...2.5	3.9	3.9	18	35
Tightening torque for power terminals	lbft	1.7	1.5...1.8	2.88	2.88	13.3	25.9
	Maximum conductor section connectable						
AWG	N°	10	8	2	2	-	-
Flexible w/o lug	mm <sup>2</sup>	6	10	35	35	-	-
Flexible c/w lug	mm <sup>2</sup>	10	6	-	-	150	2 x 150
Bar	mm	-	-	-	-	25 x 3	30 x 5
Dissipation per phase	W	0.7...2.4	0.7...2.4	2.0...4.2	2.0...4.2	0.7...2.4	0.7...2.4

### AUXILIARY CIRCUIT CHARACTERISTICS

Available contacts	NO	n°	1					
	NC	n°	1					
IEC rated insulation voltage	V	690						
IEC conventional free air thermal current $I_{th}$	A	10						
Terminals with screw and washer	Screw	M3.5						
	Terminal width	mm	8					
	Phillips	n°	1	2	1	1	2	2
Maximum conductor section connectable	Flexible w/o lug	mm <sup>2</sup>	2.5					
	Flexible c/w lug	mm <sup>2</sup>	2.5					
	Tightening torque for auxiliary terminals	Nm	1	0.8...1	1	1	0.8...1	0.8...1
lbft		0.74	0.59...0.74	0.74	0.74	0.59...0.74	0.59...0.74	
UL/CSA and IEC/EN 60947-5-1 designation		B600-P600 <sup>⑤</sup>	B600-R300	B600-P600 <sup>⑤</sup>	B600-P600 <sup>⑤</sup>	B600-R300	B600-R300	

### AMBIENT CONDITIONS

Operating temperature	°C	-20...+55	-25...+60	-20...+55	-20...+55	-25...+60	-25...+60
Storage temperature	°C	-55...+70	-50...+70	-55...+70	-55...+70	-50...+70	-50...+70
Compensation temperature	°C	-15...+55	-20...+60	-15...+55	-15...+55	-20...+60	-20...+60
Maximum altitude	m	3000					
Operation position	Normal	On vertical plane					
	Allowable	±30°					
Mounting		On contactor or separately					

<sup>①</sup> With manual and automatic resetting.

<sup>②</sup> For currents higher than 420A, consult Customer Service for information; see contact details on inside front cover.

<sup>③</sup> Standard supplied.

<sup>④</sup> Metric wrench/spanner.

<sup>⑤</sup> C600-R300 for automatic reset type.

### TRIP CHARACTERISTIC FOR RF THERMAL OVERLOAD RELAYS (AVERAGE TIME)

Three-phase balanced operation

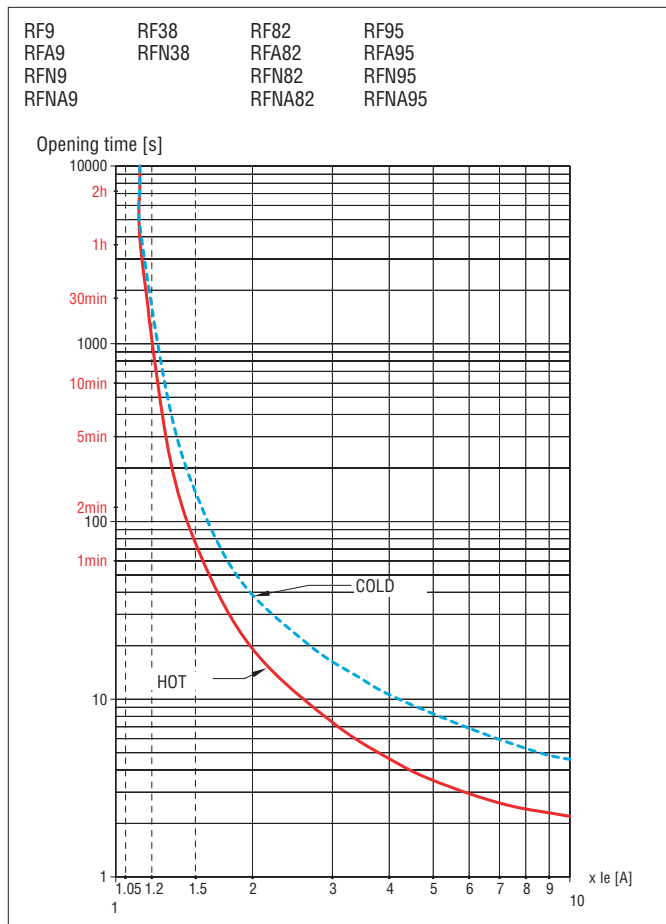

Two-phase operation (phase failure/single phase)

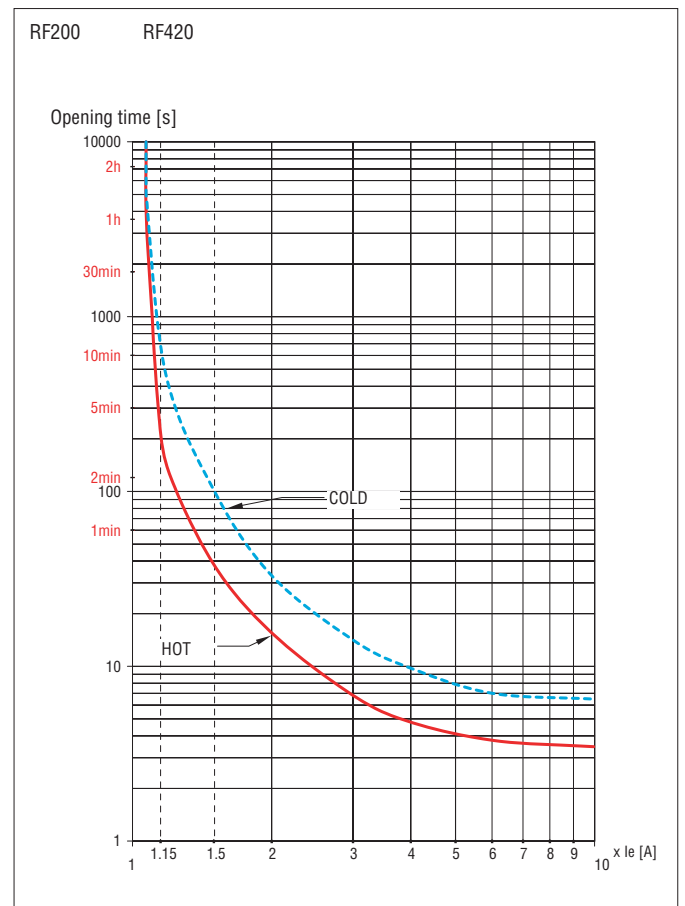
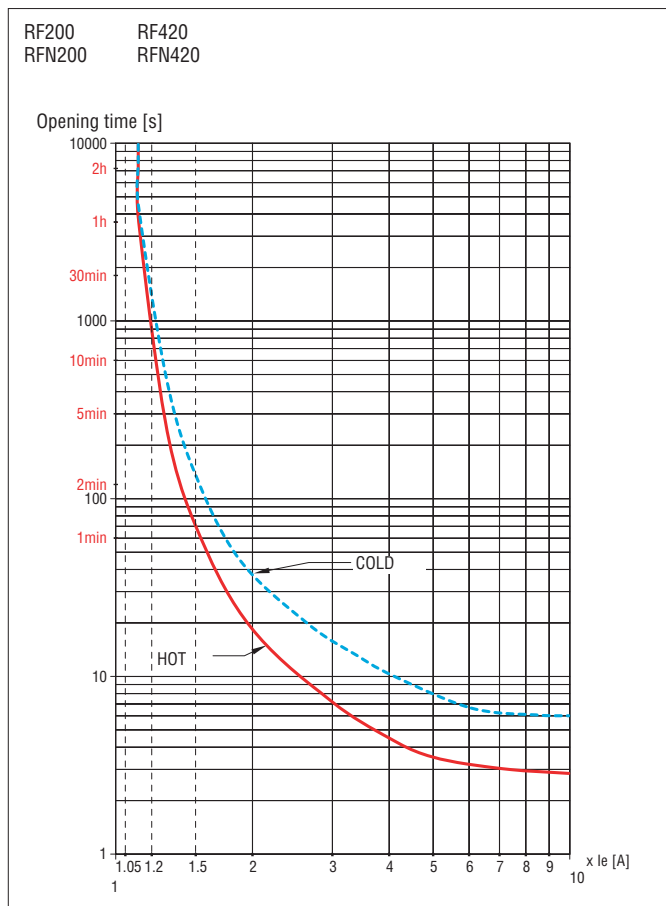
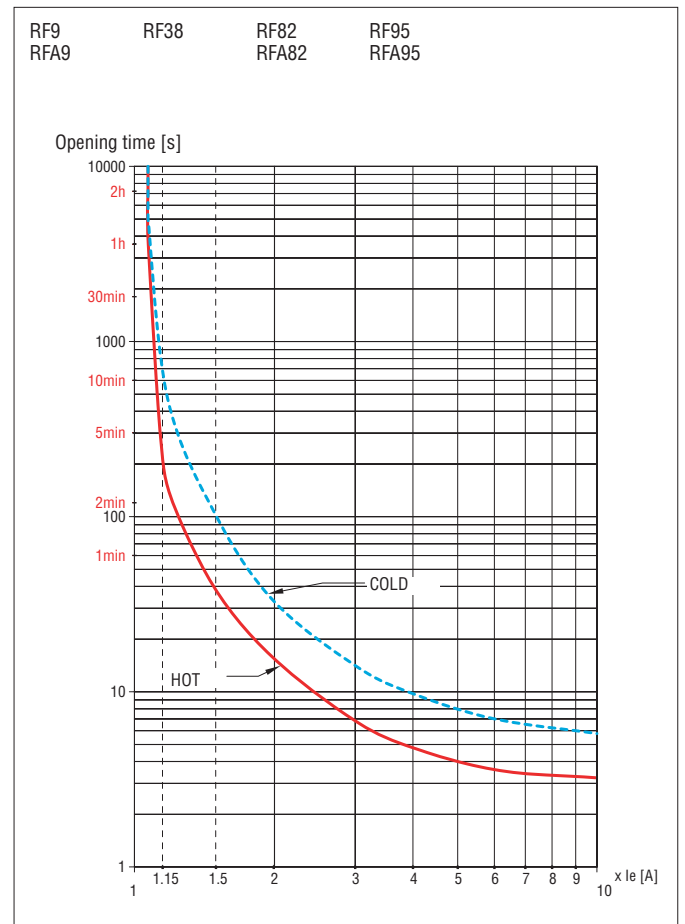

Tripping times can have a  $\pm 20\%$  deviation with respect to the average tripping curve values above.

# X-ON Electronics

Largest Supplier of Electrical and Electronic Components

*Click to view similar products for [Relay Sockets & Fixings](#) category:*

*Click to view products by [Lovato](#) manufacturer:*

Other Similar products are found below :

[M41G](#) [7-1616360-5](#) [8000-DG2-5](#) [GDA12HA](#) [GDA12HD](#) [GDA12SA](#) [GDA12SD](#) [GDA16HD](#) [GDA22HA](#) [GDA95A](#) [GDA95D](#) [GFX20](#) [GUA1](#)  
[GUA2-11](#) [GUA2-20](#) [GUA4-04](#) [GUA4-31](#) [GUM5R](#) [GUR-120](#) [GUR-24](#) [GUR-240](#) [GUR-277](#) [GURX-277](#) [GUW12](#) [GUW95](#) [GUZ32S](#) [GUZ63L](#)  
[GUZ95L](#) [AS-11](#) [AX-4MS-31](#) [AX-4MS-40](#) [2-1608090-3](#) [PB-16](#) [SM2S-61](#) [SQ9Z-C](#) [SYSWINSMP](#) [AR-12MW](#) [AR-400](#) [GDA16HA](#) [GDA16SA](#)  
[GDA16SD](#) [GDA22HD](#) [GDA22SA](#) [GDA22SD](#) [GDA32HA](#) [GDA32HD](#) [GDA32SA](#) [GDA32SD](#) [GDA63A](#) [GDA63D](#)