

2M-Series

MINIATURE TOGGLES

The 2M family of miniature toggle switches is composed of three switch series; the **2M1-Series** miniature toggle switch, the **2MS-Series** sealed miniature toggle switch, and the **2M1H-Series** premium sealed miniature toggle switch. These series all feature PC mounting and offer a variety of ratings, circuits, contact materials, terminal platings, toggle styles and lengths, and optional color caps.



Product Highlights:

- IP67 Sealing
- 8 Single and Double Pole Circuits
- Long, Short and Flatted Bushing Options
- Large Variety of Termination Options
- Available Gold, Silver and Tin Platings
- UL Approved
- Sleek Black Finish

Typical Applications:

- Telecommunications
- Instrumentation
- Networking
- Medical Equipment
- Military Communications

Resources:

[Download 3D CAD Files](#)

[IGS >](#) [STP >](#)



Carling Technologies, Inc.
60 Johnson Avenue, Plainville, CT 06062
Email: sales@carlingtech.com
Application Support: team2@carlingtech.com
Phone: 860.793.9281 Fax: 860.793.9231

www.carlingtech.com



2M1H-Series
Premium Sealed
Miniature
Toggle Switch



2MS-Series
Sealed
Miniature
Toggle Switch



2M1-Series
Miniature
Toggle Switch

Electrical

Contact Rating refer to ordering scheme
 Electrical Life 50,000 make & break cycles @ full load
 Contact Resistance 10 mΩ max. initial @ 2-4 VDC
 100mA for both silver & gold plated contacts
 Insulation Resistance 1000 MΩ min.
 Dielectric Strength 1500 Volts RMS @ sea level

Physical

Operating Temperature -30°C to +85°C
 Index of Protection *2M1H-Series:* IP67
2MS-Series: IP67
 Solder Heat Resistance MIL-STD-202, Method 210
 Actuator Travel 25°

Material

Case *2M1H-Series & 2M1-Series:* Dially phthalate (DAP) (UL 94V-0)
2MS-Series: Glass filled nylon 6/6, flame retardant, heat stabilized (UL 94V-0)
 Toggle *2M1H-Series:* Brass, black finish with o-ring seal
2MS-Series: Brass, chrome plated, internal o-ring sealed
2M1-Series: Brass, chrome plated
 Bushing *2M1H-Series:* Brass, black finish with o-ring seal
2MS-Series: Glass filled nylon 6/6, flame retardant, heat stabilized (UL 94V-0)
2M1-Series: Brass, nickel plated
 Housing Stainless Steel
 Bracket *2MS-Series:* Nylon (UL 94V-0)
2M1-Series: Stainless Steel
 Actuator Pivot Retainer *2MS-Series:* Stainless Steel
 Switch Support Brass, tin plated
 Terminal Seal Epoxy

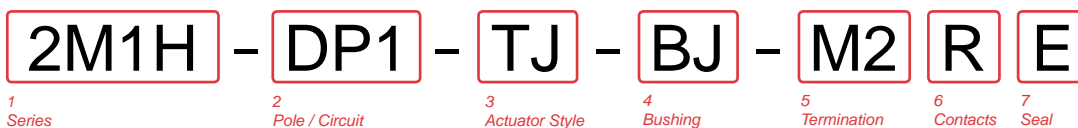

1 SERIES
2M1H Premium Sealed Miniature Toggle Switch

2 POLE / CIRCUIT
 () - momentary
Position:

	1	2	3
	2-3, 5-6	Connected Terminals	2-1, 5-4
SP1	ON	NONE	ON
SP2	ON	NONE	(ON)
SP3	ON	OFF	ON
SP4	(ON)	OFF	(ON)
SP5	ON	OFF	(ON)
DP1	ON	NONE	ON
DP2	ON	NONE	(ON)
DP3	ON	OFF	ON
DP4	(ON)	OFF	(ON)
DP5	ON	OFF	(ON)
DP6 *	ON	ON	ON
DP7 *	(ON)	ON	(ON)
DP8 *	ON	ON	(ON)

*Center position connects 2-3, 5-4

3 ACTUATOR STYLE
TJ .709" [18 mm] length **TK** .512" [13.00 mm] length

4 BUSHING
BJ .429" [10.90 mm] threaded, length **BK** .386" [9.80 mm] threaded, flat

5 TERMINATION ⁷

M1	Solder Lug	M51	Wire Wrap, .750" [19.05mm] length
M2	PCB	M52	Wire Wrap, .964" [24.48mm] length
M3	Quick Connect	M53	Wire Wrap, .425" [10.80mm] length
		M54	Wire Wrap, 1.062" [25.97mm] length

6 CONTACTS / TERMINALS

	Contact Material	Terminal Plating	Rating	Approvals
G	silver ¹	gold over silver	5A 125VAC or 28VDC, 2A 250VAC	IP67
K	gold ^{2,5}	tin ^{4,7}	0.4VA max 20V max (AC/DC)	IP67
P	silver ^{1,6}	tin ^{4,7}	5A 125VAC or 28VDC, 2A 250VAC	IP67
Q	silver ¹	silver ¹	5A 125VAC or 28VDC, 2A 250VAC	IP67
R	gold ²	gold ³	0.4VA max 20V max (AC/DC)	IP67

7 EPOXY SEAL
E Epoxy Seal

- Notes:
 Switches supplied with (1) 2M1-HDW4 hex nut and (1) 3MNH-WCP-0872 O-Ring
 1 Movable contact and terminal platings: silver over copper alloy
 2 Movable contact and terminal platings: gold over nickel over copper alloy
 3 Terminal platings: gold over nickel over copper alloy
 4 Terminal platings: tin over copper alloy
 5 Terminal contact platings: gold over nickel alloy
 6 Terminal contact platings: silver over nickel alloy
 7 Tin option not available with M1 & M3 terminations.

*Manufacturer reserves the right to change product specification without prior notice.

2MS - WSP 1 - T1 - B4 - M1 G E

1 Series 2 Poles 3 Circuit 4 Actuator Style 5 Bushing 6 Termination 7 Contacts 8 Seal

1 SERIES

2MS Sealed Miniature Toggle Switch

2 POLES

WSP Single pole - uses terminals 1, 2 & 3
WDP Double pole - uses terminals 1, 2, 3, 4, 5 & 6
W3P Three pole - uses terminals 1, 2, 3, 4, 5, 6, 7, 8 & 9

3 CIRCUIT

() - momentary

Position:	1	2	3
	2-3, 5-6, 8-9	Connected Terminals	2-1, 5-4, 8-7
1	ON	NONE	ON
2	ON	NONE	(ON)
3	ON	OFF	ON
4	(ON)	OFF	(ON)
5	ON	OFF	(ON)

4 ACTUATOR STYLE

T1 Round Bat **T9** Long Black Plastic .492" length
T2 Round Short Bat **P1** Plastic Anti-Static .496" length
P2 Plastic Anti-Static .299" length

5 BUSHING

B1 Threaded, Keyway **B4** Unthreaded, Short, Keyway, Flat

6 TERMINATION

M1 ⁴	Solder Lug	VS21	Vertical, Snap-In, .460" [11.70mm]
M2	PCB	VS3	Vertical, .630" [16mm]
M3	Quick Connect	VS31	Vertical, Snap-In, .630" [16mm]
M51	Wire Wrap, .750" [19.05mm]	U2	Vertical, .551" [14mm] - only 3PDT
M52	Wire Wrap, .964" [24.48mm]	VS4	Vertical, .461" [11.70mm]
M53	Wire Wrap, .425" [10.80mm]	VS41	Vertical, Snap-In, .461" [11.70mm]
M54	Wire Wrap, 1.062" [25.97mm]	U4	Vertical, .551" [14mm] - only 3PDT
M6	Right Angle, PC Thru-Hole	VS5	Vertical, .630" [16mm]
M61	Right Angle, Snap-In	VS51	Vertical, Snap-In, .630" [16mm]
M7	Vertical, Right Angle, PC Thru-Hole		
M71	Vertical, Right Angle, Snap-In		
VS2	Vertical, .461" [11.70mm]		

7 CONTACTS / TERMINALS

	Contact Material	Terminal Plating	Rating	Approvals
G	silver ¹	gold over silver	5A 125VAC or 28VDC, 2A 250VAC	eTÜS, IP67
K	gold ²	tin ^{3,4}	0.4VA max 20V max (AC/DC)	IP67
P	silver ¹	tin ^{3,4}	5A 125VAC or 28VDC, 2A 250VAC	eTÜS, IP67
R	gold ²	gold ²	0.4VA max 20V max (AC/DC)	IP67

8 EPOXY SEAL

E Epoxy Seal **0** without Epoxy Seal

Notes:

- B1 Bushing switches supplied with (2) 2M1-HDW2 nuts, (1) 2M1-HDW11 washer and (1) 2M1-HDW15 locking ring. See page 76-77.
 1 Movable contact & terminal platings: silver over copper alloy
 2 Movable contact & terminal platings: gold over nickel over copper alloy
 3 Terminal platings: tin over nickel over copper alloy
 4 Tin option not available with M1 terminal

2M1 - SP 1 - T1 - B1 - M1 Q E

1 Series 2 Poles 3 Circuit 4 Actuator Style 5 Bushing 6 Termination 7 Contacts 8 Seal

1 SERIES

2M1 Miniature Toggle Switch

2 POLES

SP Single pole - uses terminals 1, 2 & 3
DP Double pole - uses terminals 1, 2, 3, 4, 5 & 6
3P Three pole - uses terminals 1, 2, 3, 4, 5, 6, 7, 8 & 9
4P Three pole - uses terminals 1, 2, 3, 4, 5, 6, 7, 8, 9, 10, 11 & 12

3 CIRCUIT

() - momentary

Position:	1	2	3
	2-3, 5-6, 8-9, 11-12	Connected Terminals	2-1, 5-4, 8-7, 11-10
1	ON	NONE	ON
2	ON	NONE	(ON)
3	ON	OFF	ON
4	(ON)	OFF	(ON)
5	ON	OFF	(ON)
6*	ON	ON	ON
7*	(ON)	ON	(ON)
8*	ON	ON	(ON)

*Available with DP and 4P switches only. Center position connects 2-3, 5-4, 8-9, 11-10

4 ACTUATOR STYLE

T1 Round Bat **T7** Large Bat (B0 bushing)
T2 Round Short Bat **T8** X-Large Bat (B0 bushing)
T3 Paddle **T9** Black Plastic
T4 Medium Paddle **T0** Rectangular
T5 Long Paddle **TA** Locking Lever
T6 Flat (B1,B2,B5,BA,BB,BE) **TI** Locking Lever
TL Locking Lever

5 BUSHING

B1 Threaded Standard, keyway **B8** Metric
B2 Non-Threaded Standard, keyway **B9** Splashproof
B3 Threaded Short, keyway **B0** 15/32" Threaded (Standard for T7 & T8 actuator styles)
B4 Non-Threaded Short, keyway **BA** Threaded for T6
B5 High Torque, 7.5mm, flat **BB** Non-Threaded for T6
B6 High Torque, 8.0mm, keyway **BE** Threaded Hi Torque for T6
B7 Long threaded **BL** Threaded, Locking

6 TERMINATION

M1 ⁴	Solder Lug	M71	Vertical, Right Angle, Snap-In
M2	PCB	VS2	Vertical, .461" [11.70mm]
M3	Quick Connect	VS21	Vertical, Snap-In, .461" [11.70mm]
M51	Wire Wrap, .750" [19.05mm]	VS3	Vertical, .630" [16mm]
M52	Wire Wrap, .964" [24.48mm]	VS31	Vertical, Snap-In, .630" [16mm]
M53	Wire Wrap, .425" [10.80mm]	VS4	Vertical, .461" [11.70mm]
M54	Wire Wrap, 1.062" [25.97mm]	VS41	Vertical, Snap-In, .461" [11.70mm]
M6	Right Angle, PC Thru-Hole	VS5	Vertical, .630" [16mm]
M61	Right Angle, Snap-In	VS51	Vertical, Snap-In, .630" [16mm]
M7	Vertical, Right Angle, PC Thru-Hole		

7 CONTACTS / TERMINALS

	Contact Material	Terminal Plating	Rating	Approvals
G	silver ¹	gold over silver	5A 125VAC or 28VDC, 2A 250VAC	TÜS, IP67
K	gold ²	tin ^{3,4}	0.4VA max 20V max (AC/DC)	N/A
P	silver ¹	tin ^{3,4}	5A 125VAC or 28VDC, 2A 250VAC	TÜS, IP67
Q	silver ¹	silver ¹	5A 125VAC or 28VDC, 2A 250VAC	TÜS, IP67
R	gold ²	gold ²	0.4VA max 20V max (AC/DC)	N/A

8 EPOXY SEAL

E Epoxy Seal **0** without Epoxy Seal

Notes:

- B1 Bushing switches supplied with (2) 2M1-HDW2 nuts, (1) 2M1-HDW11 washer and (1) 2M1-HDW15 locking ring.
 1 Movable contact & terminal platings: silver over copper alloy
 2 Movable contact & terminal platings: gold over nickel over copper alloy
 3 Terminal platings: tin over nickel over copper alloy
 4 Tin option not available with M1 terminal

2M-Series Accessories

To order accessories assembled on a switch, specify the switch number followed by the accessory part number and the word "assembled". Ex: 2M1-SP1-T1-B1-M1QE-T12 ASSEMBLED. To order accessories in bulk, specify the Series, followed by the accessory. Ex: 2M1-T12. See page 76 for dimensional specifications.

Optional Toggle Cap

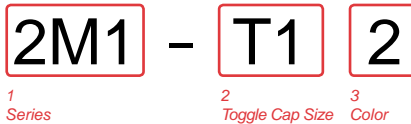

1 SERIES
2M1 Fits 2M1H, 2MS or 2M1

2 TOGGLE CAP SIZE
T1 10.6 mm **T2** 7.6 mm

3 CAP COLOR

1 White	5 Yellow
2 Black	6 Green
3 Red	7 Blue

Optional Dress and Knurled Nuts

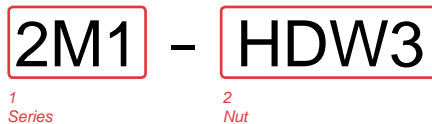

1 SERIES
2M1 Fits 2M1H, 2MS or 2M1

2 NUT
HDW3 Dress nut for 1/4" bushing
HDW5 Knurled nut for 15/32" bushing (2M1-Series only)

Optional Rubber Seals

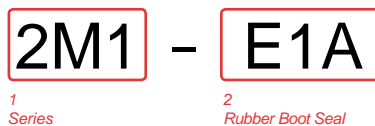

1 SERIES
2M1 Fits 2M1H, 2MS or 2M1

2 RUBBER BOOT SEAL
E1A 1/4 - 40" UNS bushing (Not available for B0 bushing option)
K1 Metric M6 bushing (B8 bushing only)
YE1D 15/32 - 32" UNS bushing (TJ, TK and B0 bushings only)
YE1E 15/32 - 32" UNS bushing 1/2 boot (T7, T8, TJ, TK and B0 bushings only)

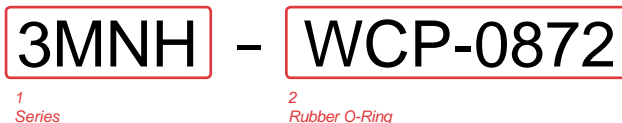

1 SERIES
3MNH Fits 3MNH or 2M1H

2 RUBBER O-RING
WCP-0872 For 15/32 bushing option

2M1H-Series Dimensional Specifications: in. [mm]

Single Pole

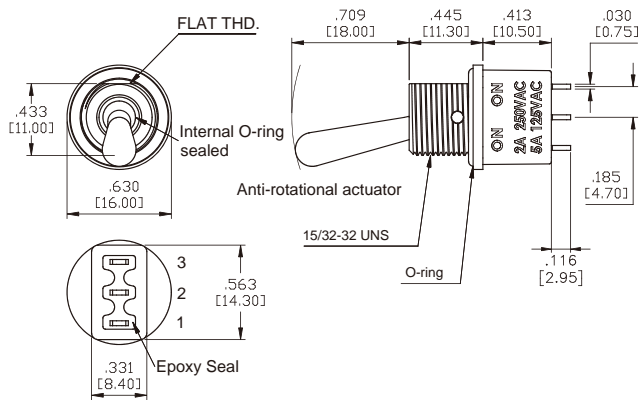

Double Pole

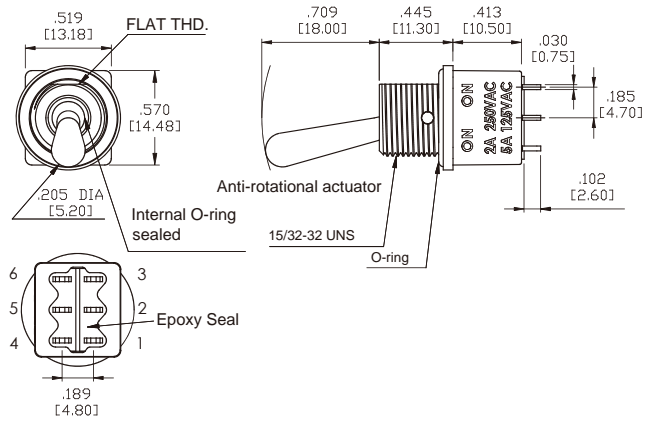

Actuator Options

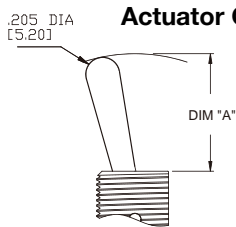

OPTION CODE	DIM. "A"
TJ	.709 [18.00]
TK	.512 [13.00]

Bushing Options & Mounting

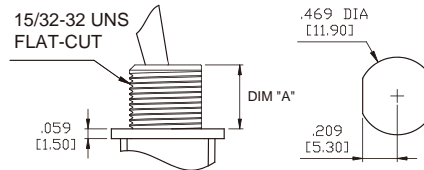

OPTION CODE	DIM. "A"
BJ	.429 [10.90]
BK	.386 [9.80]

Termination Options

M1 Standard Solder Lug

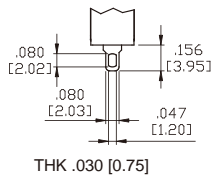

M2 PC Thru-Hole

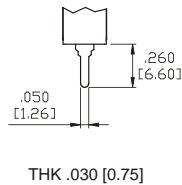

M3 Quick Connect

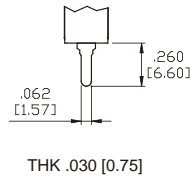

M5 Wire Wrap

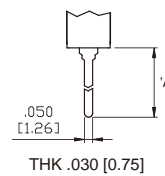

OPTION CODE	DIM. "A"
M5-1	.750 [19.05]
M5-2	.964 [24.48]
M5-3	.425 [10.80]
M5-4	1.062 [26.97]

2MS-Series Dimensional Specifications: in. [mm]

Single Pole

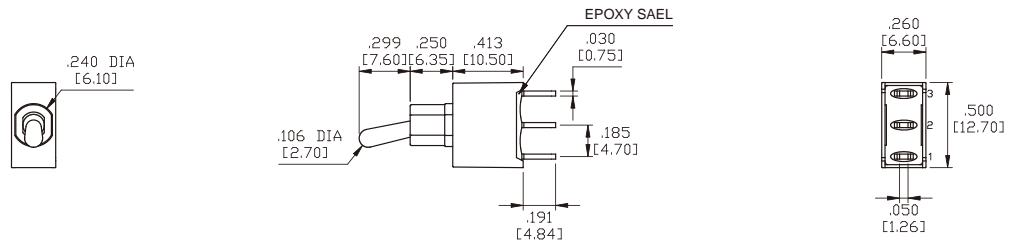

Double Pole

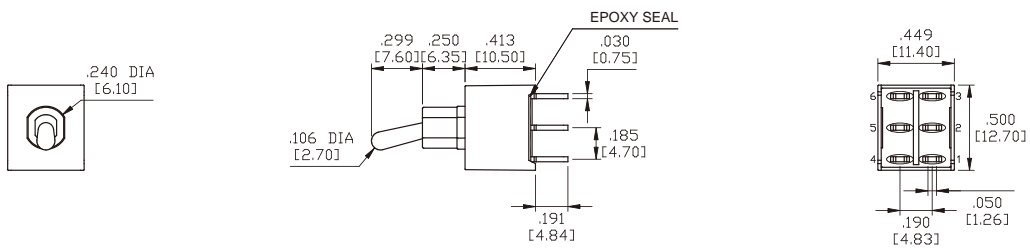

Three Pole

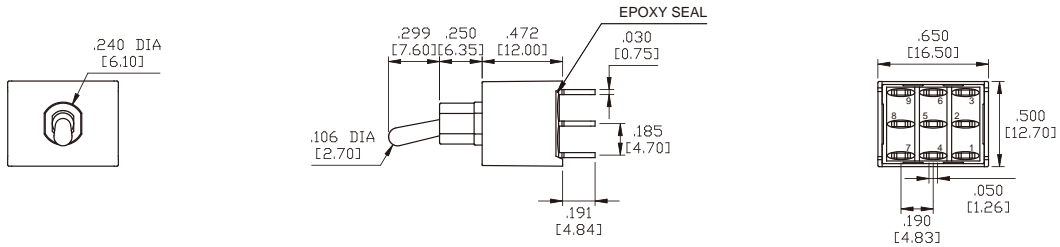

Actuator Options

T1

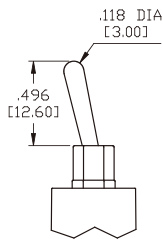

T2

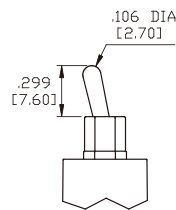

T9 with Plastic Cap

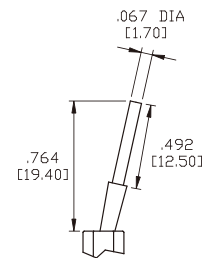

NO.	COLOR
1	White
2	Black(std.)
3	Red
4	Orange
5	Yellow
6	Green
7	Blue
8	Brown
9	Gray

P1 Plastic Toggle

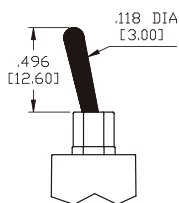

P2 Plastic Toggle

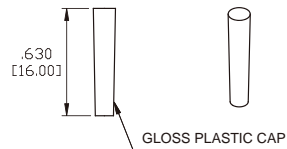
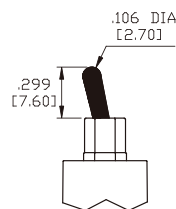

* Shown with B4 bushing. Subtract .075" (1.90 mm) from actuator height for B1 bushing.

2MS-Series Dimensional Specifications: in. [mm]

Bushing Options

B1

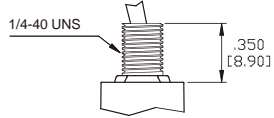

B4

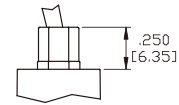

Termination Options

M1 Standard Solder Lug

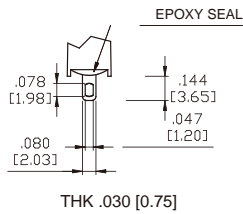

M2 PC Thru-Hole

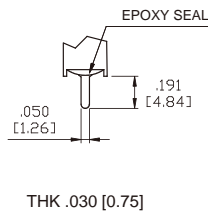

M3 Quick Connect

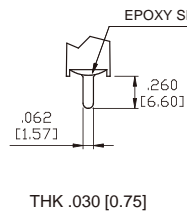

M5 Wire Wrap

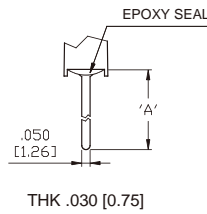

OPTION CODE	DIM.'A'
M5-1	.750 [19.05]
M5-2	.964 [24.48]
M5-3	.425 [10.80]
M5-4	1.062 [26.97]

M6 Single Pole

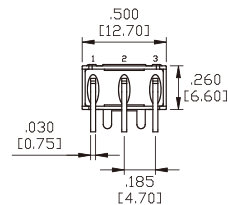
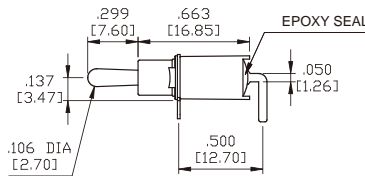
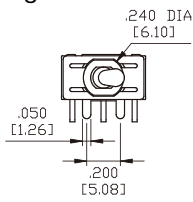

P.C.MOUNTING

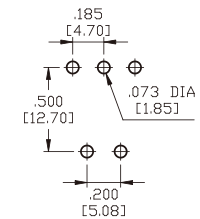

M6 Double Pole

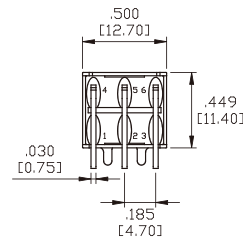
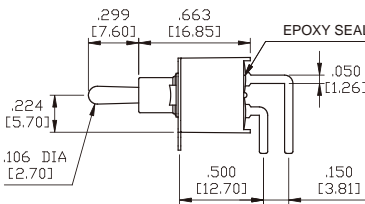
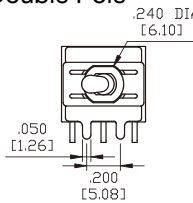

P.C.MOUNTING

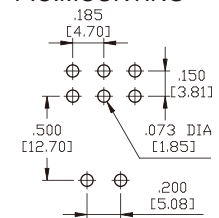

M6 Three Pole

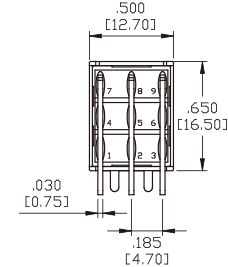
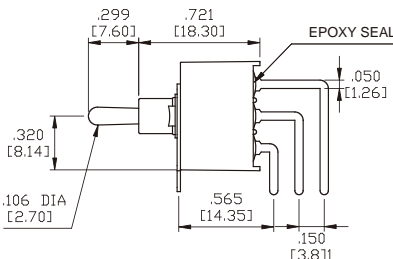
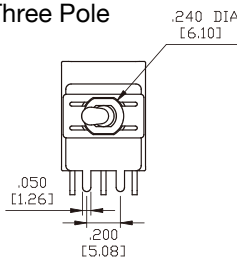

P.C.MOUNTING

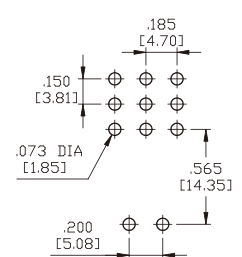

M7 Single Pole

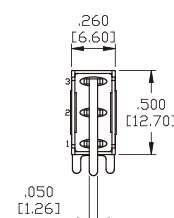
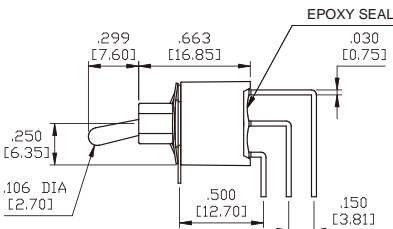
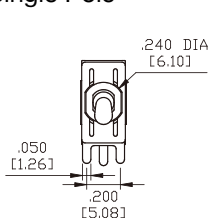

P.C.MOUNTING

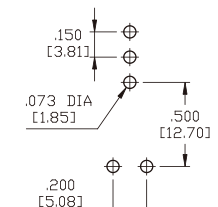

2MS-Series Dimensional Specifications: in. [mm]

Termination Options

M7 Double Pole

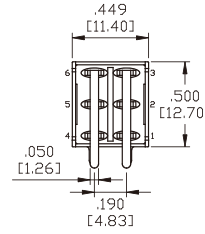
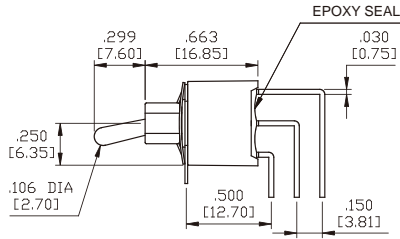
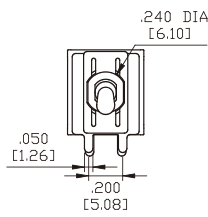

P.C.MOUNTING

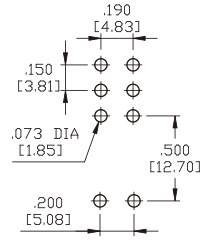

M7 Three Pole

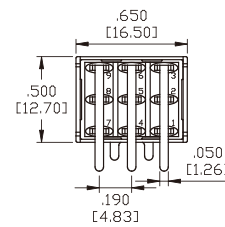
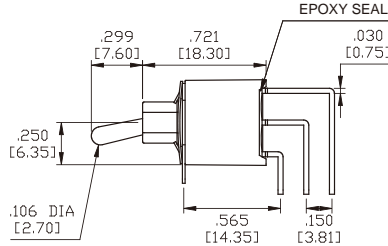
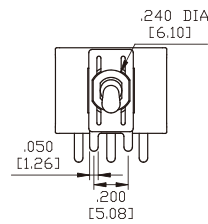

P.C.MOUNTING

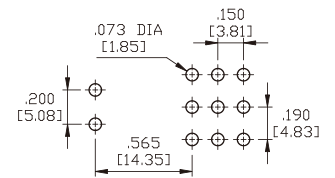

VS2-VS3 Single Pole

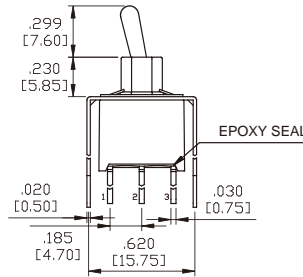
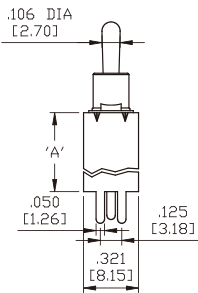

OPTION CODE	DIM.'A'
VS2	.461 [11.70]
VS3	.630 [16.00]

P.C.MOUNTING

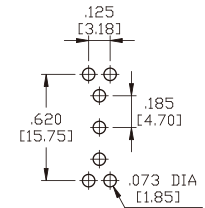

VS2-VS3 Double Pole

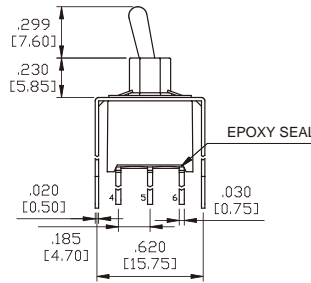
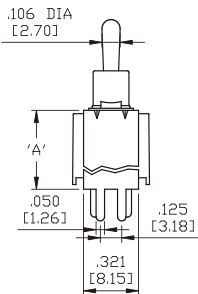

OPTION CODE	DIM.'A'
VS2	.461 [11.70]
VS3	.630 [16.00]

P.C.MOUNTING

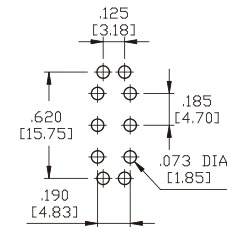

U2-VS3 Three Pole

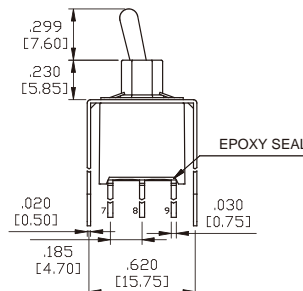
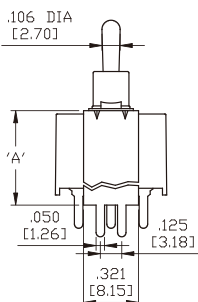

OPTION CODE	DIM.'A'
U2	.551 [14.00]
VS3	.630 [16.00]

P.C.MOUNTING

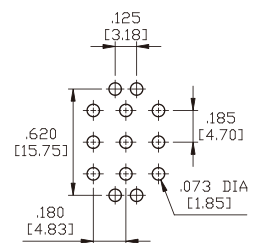

2MS-Series Dimensional Specifications: in. [mm]

Termination Options

VS4-VS5 Single Pole

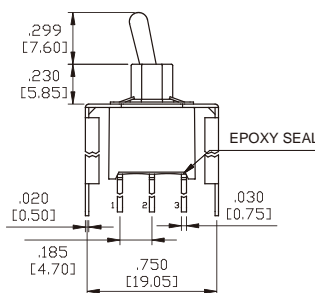
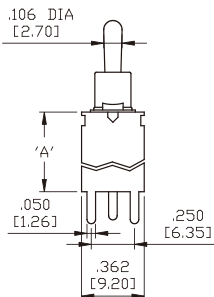

OPTION CODE	DIM.'A'
VS4	.461 [11.70]
VS5	.630 [16.00]

P.C.MOUNTING

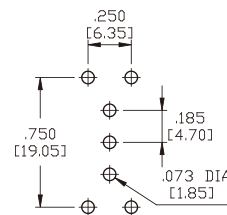

VS4-VS5 Double Pole

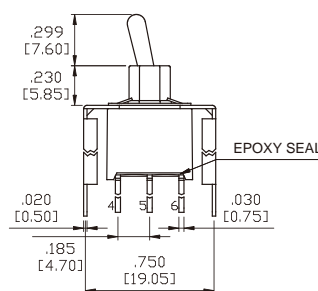
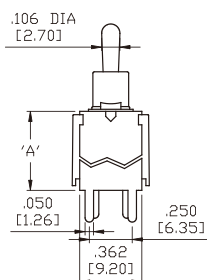

OPTION CODE	DIM.'A'
VS4	.461 [11.70]
VS5	.630 [16.00]

P.C.MOUNTING

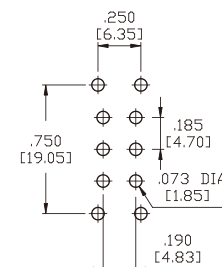

U4-VS5 Three Pole

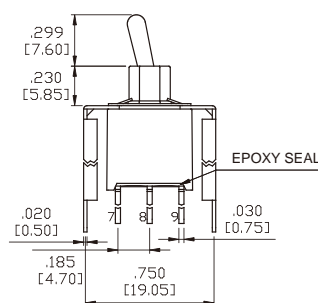
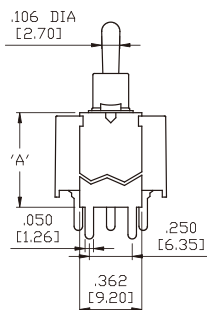

OPTION CODE	DIM.'A'
U4	.551 [14.00]
VS5	.630 [16.00]

P.C.MOUNTING

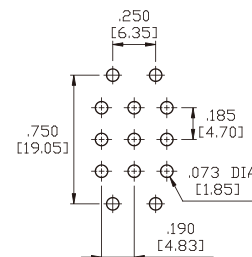

Snap-In Termination Options

M61

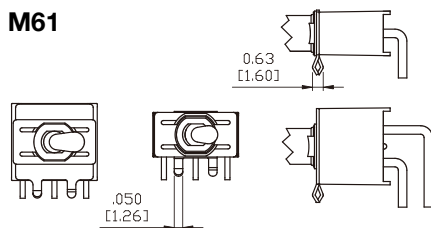

VS21, VS31

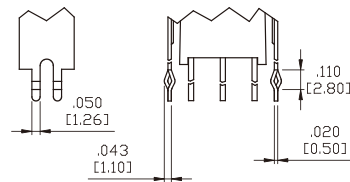

M71

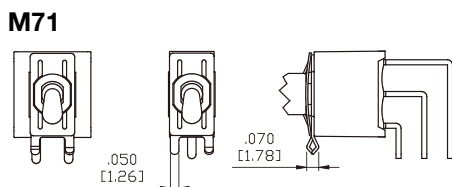

VS41, VS51

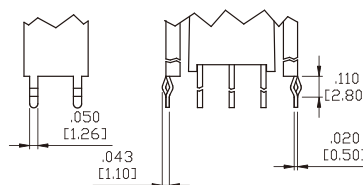

* PC Mounting for M61, M71, VS21, VS31, VS41, VS51 refer to M6, M7, VS2, VS3, VS4, VS5 respectively.

2M1-Series Dimensional Specifications: in. [mm]

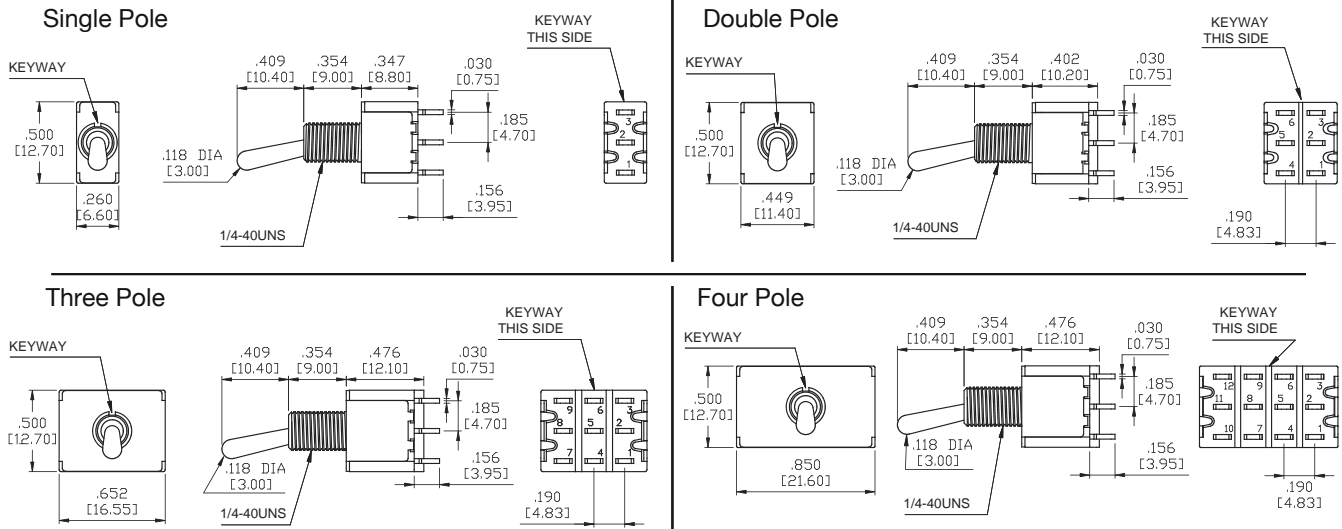

Actuator Options for Panel Rear Mount

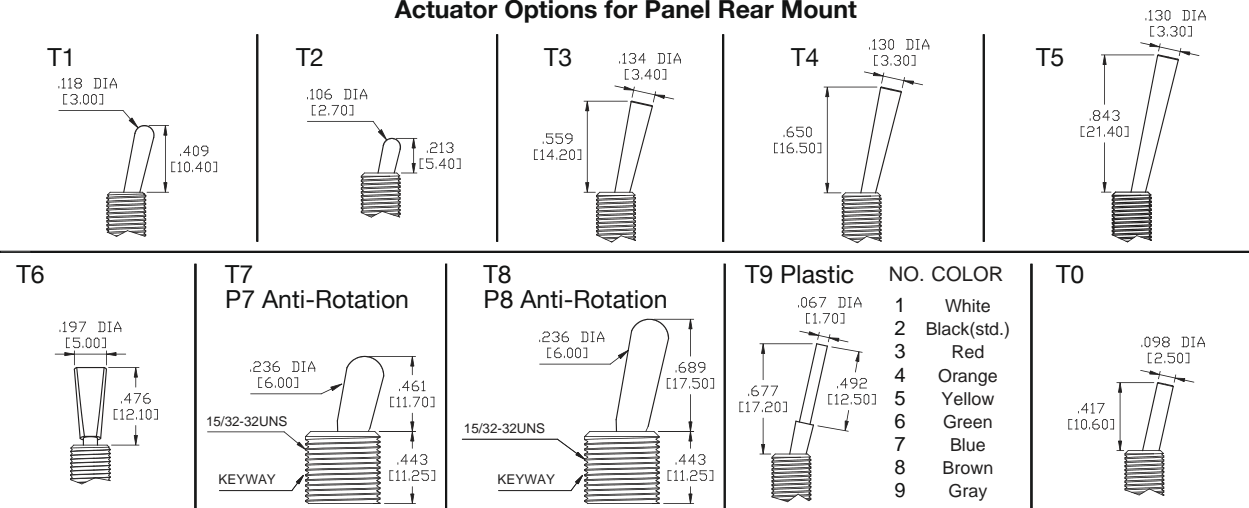

* T6 actuator is available with B1, B2, B5, B6, BA, BB & BE bushing. Actuator length shown for T1 – T5, T9 and T10 is with B1 bushing. T7, P7, T8 & P8 does not require a bushing code.

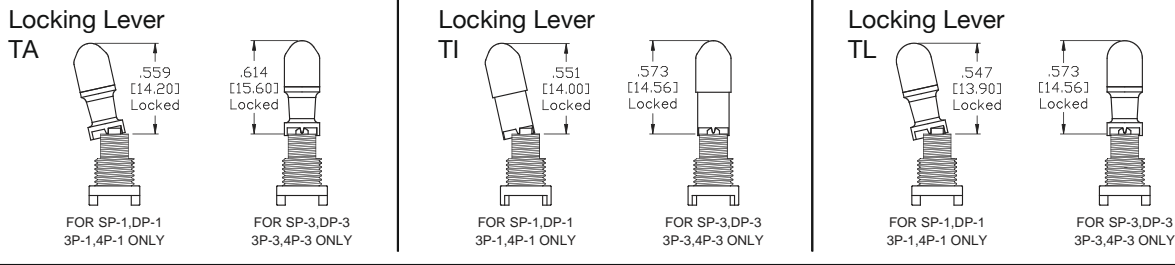

Bushing Options

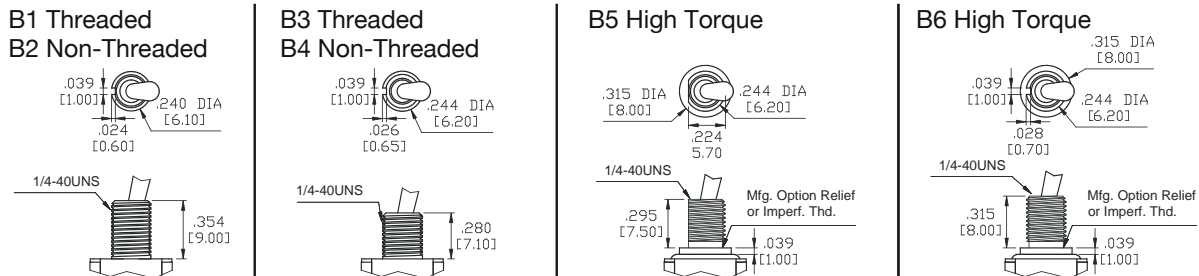

2M1-Series Dimensional Specifications: in. [mm]

Bushing Options

B7 Long

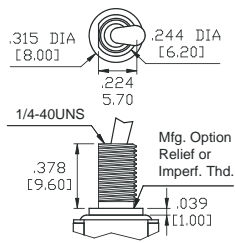

B8 Metric

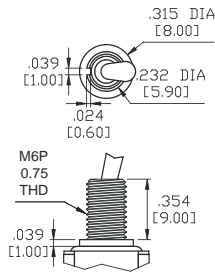

B9 Splash-Proof

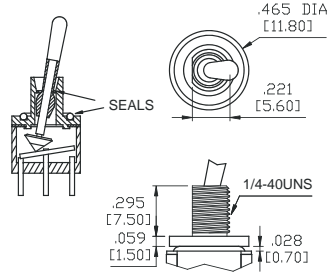

BL Locking Lever

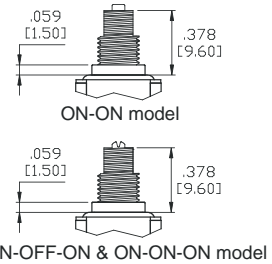

BA Threaded for T6

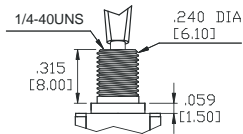

BB Non-Threaded for T6

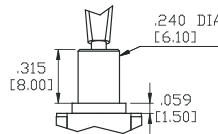

BB High Torque for T6

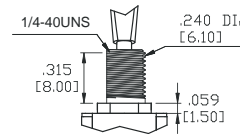

Panel Mounting

1/4 INCH BUSHING

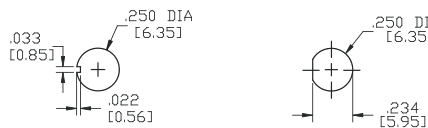

15/32 INCH BUSHING

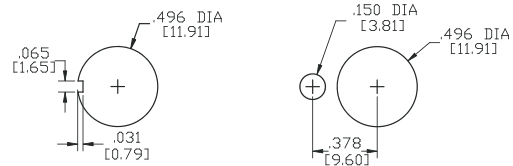

Termination Options

M1 Standard Solder Lug

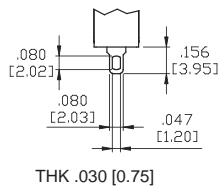

M2 PC Thru-Hole

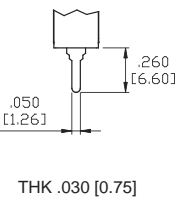

M3 Quick Connect

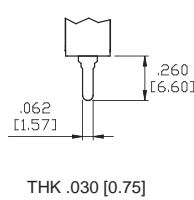

M5 Wire Wrap

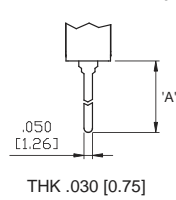

OPTION CODE	DIM.'A'
M5-1	.750 [19.05]
M5-2	.964 [24.48]
M5-3	.425 [10.80]
M5-4	1.062 [26.97]

M6 Single Pole

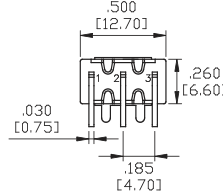
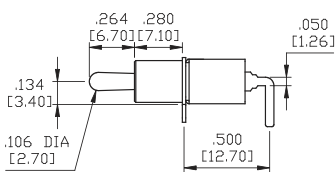
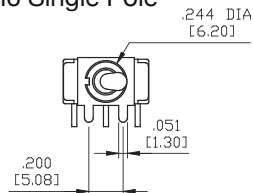

P.C. MOUNTING

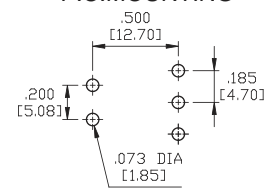

M6 Double Pole

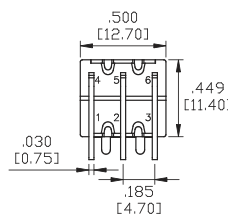
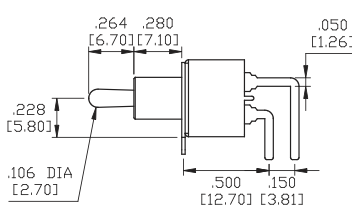
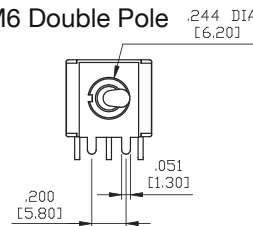

P.C. MOUNTING

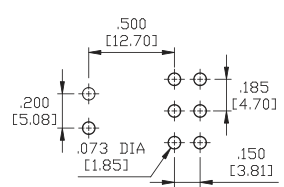

2M1-Series Dimensional Specifications: in. [mm]

Termination Options

M6 Three Pole .244 DIA [6.20]

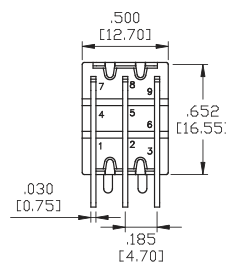
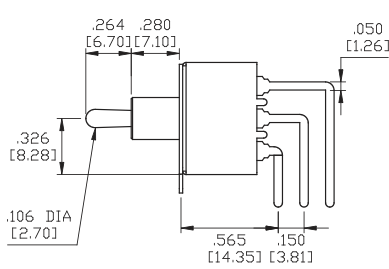
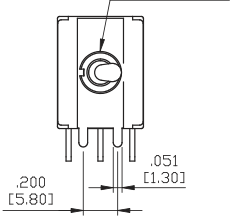

P.C.MOUNTING

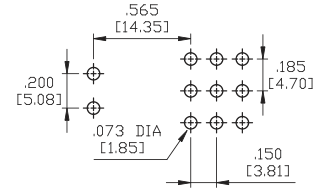

M7 Single Pole .244 DIA [6.20]

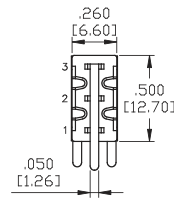
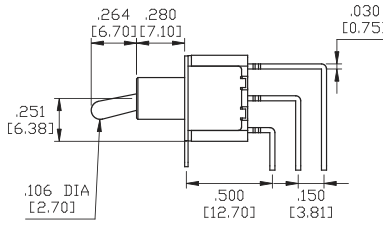
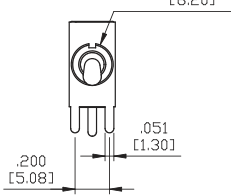

P.C.MOUNTING

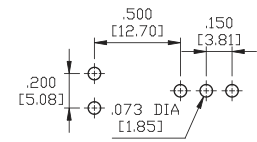

M7 Double Pole .244 DIA [6.20]

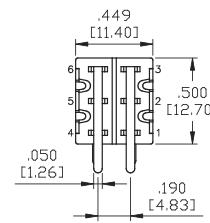
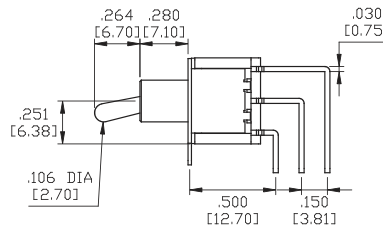
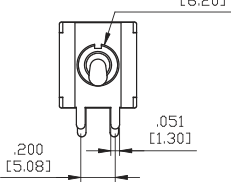

P.C.MOUNTING

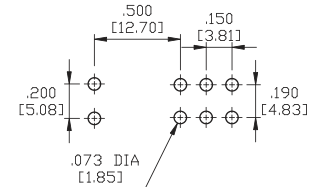

M7 Three Pole .244 DIA [6.20]

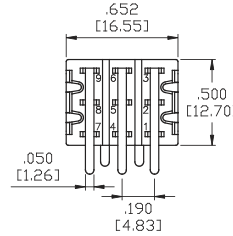
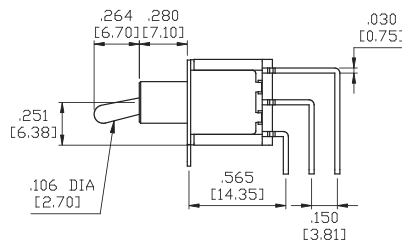
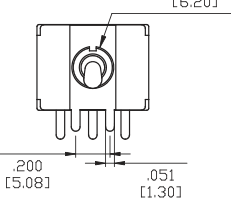

P.C.MOUNTING

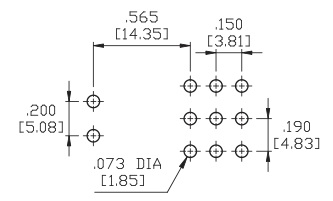

M7 Four Pole .244 DIA [6.20]

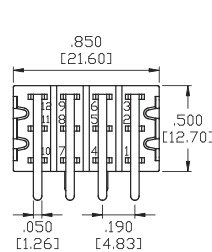
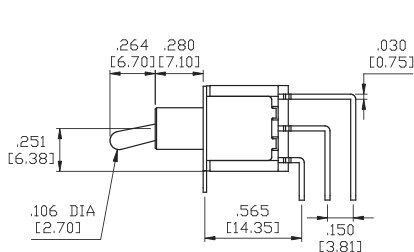
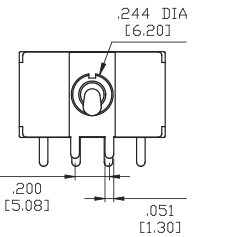

P.C.MOUNTING

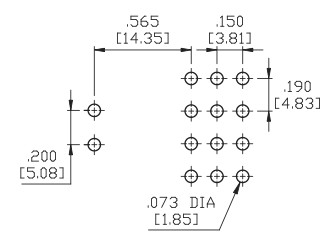

VS2-VS3 Single Pole

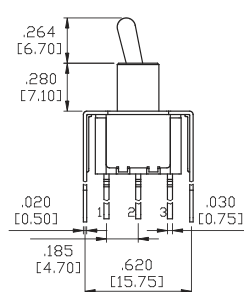
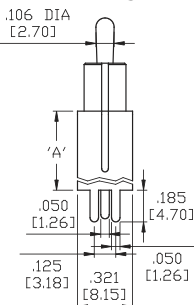

OPTION CODE	DIM. 'A'
VS2	.461 [11.70]
VS3	.630 [16.00]

P.C.MOUNTING

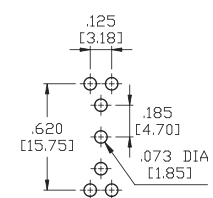

2M1-Series Dimensional Specifications: in. [mm]

Termination Options

VS2-VS3 Double Pole

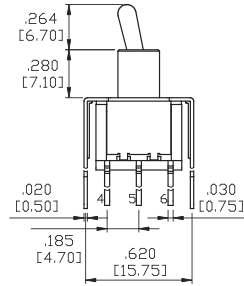
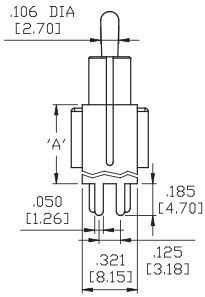

OPTION CODE	DIM. 'A'
VS2	.461 [11.70]
VS3	.630 [16.00]

P.C.MOUNTING

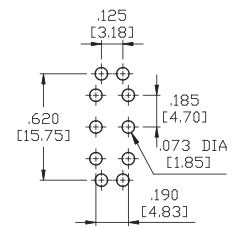

VS4-VS5 Single Pole

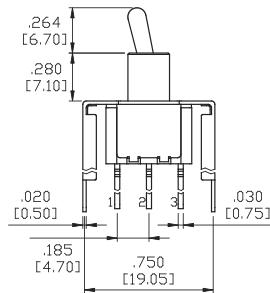
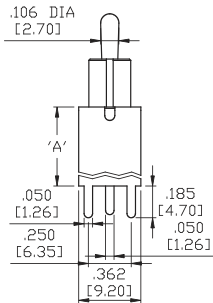

OPTION CODE	DIM. 'A'
VS4	.461 [11.70]
VS5	.630 [16.00]

P.C.MOUNTING

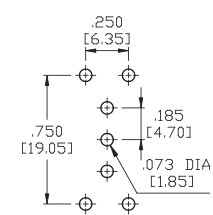

VS4-VS5 Double Pole

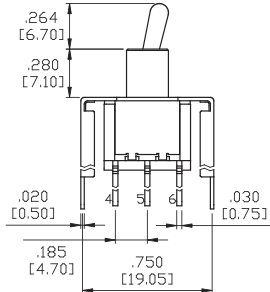
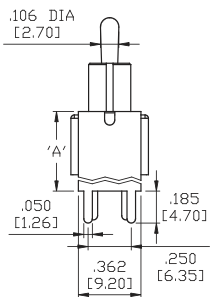

OPTION CODE	DIM. 'A'
VS4	.461 [11.70]
VS5	.630 [16.00]

P.C.MOUNTING

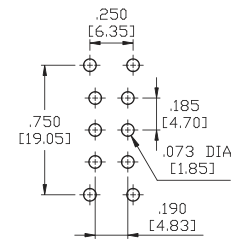

Snap-In Termination Options

M61 (available with SP & DP)

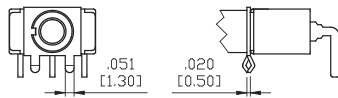

VS21, VS31

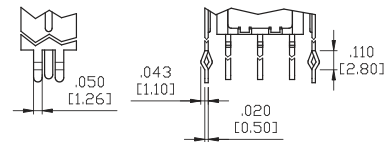

M71 (available with SP & DP)

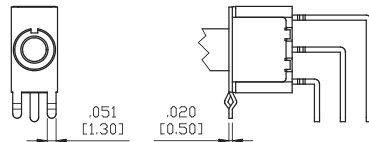

VS41, VS51

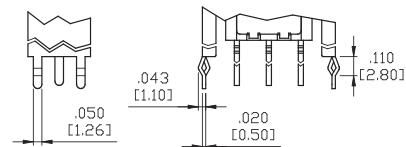

* PC Mounting for M61, M71, VS21, VS31, VS41, VS51 refer to M6, M7, VS2, VS3, VS4, VS5 respectively.

Authorized Sales Representatives and Distributors

Click on a region of the map below to find your local representatives and distributors or visit www.carlingtech.com/findarep.



About Carling

Founded in 1920, Carling Technologies is a leading manufacturer of electrical and electronic switches and assemblies, circuit breakers, electronic controls, power distribution units, and multiplexed power distribution systems. With four ISO registered manufacturing facilities and technical sales offices worldwide, Carling Technologies Sales, Service and Engineering teams do much more than manufacture electrical components, they engineer powerful solutions! To learn more about Carling please visit www.carlingtech.com/company-profile.

To view all of Carling's environmental, quality, health & safety certifications please visit www.carlingtech.com/environmental-certifications

Worldwide Headquarters

Carling Technologies, Inc.
60 Johnson Avenue, Plainville, CT 06062
Phone: 860.793.9281 **Fax:** 860.793.9231
Email: sales@carlingtech.com

Northern Region Sales Office: nrsm@carlingtech.com
Southeast Region Sales Office: sersm@carlingtech.com
Midwest Region Sales Office: mrrsm@carlingtech.com
West Region Sales Office: wrsm@carlingtech.com
Latin America Sales Office: larsm@carlingtech.com

Asia-Pacific Headquarters

Carling Technologies, Asia-Pacific Ltd.,
Suite 1607, 16/F Tower 2, The Gateway,
Harbour City, 25 Canton Road,
Tsimshatsui, Kowloon, Hong Kong
Phone: Int + 852-2737-2277 **Fax:** Int + 852-2736-9332
Email: sales@carlingtech.com.hk

Shenzhen, China: shenzhen@carlingtech.com
Shanghai, China: shanghai@carlingtech.com
Pune, India: india@carlingtech.com
Kaohsiung, Taiwan: taiwan@carlingtech.com
Yokohama, Japan: japan@carlingtech.com

Europe | Middle East | Africa Headquarters

Carling Technologies LTD
4 Airport Business Park, Exeter Airport,
Clyst Honiton, Exeter, Devon, EX5 2UL, UK
Phone: Int + 44 1392.364422 **Fax:** Int + 44 1392.364477
Email: ltd.sales@carlingtech.com

Germany: gmbh@carlingtech.com
France: sas@carlingtech.com



Carling Technologies®

Innovative Designs. Powerful Solutions.

X-ON Electronics

Largest Supplier of Electrical and Electronic Components

Click to view similar products for [Toggle Switches](#) category:

Click to view products by [Carling](#) manufacturer:

Other Similar products are found below :

[A19HV](#) [8A1-C-222](#) [60012L](#) [6006L](#) [6663](#) [7101MD9V30GE](#) [7101SPDV30BE](#) [7103SDV30BE](#) [7105D](#) [7108P3YAV2BE](#) [71YY50282](#)
[7201MD9AVBE](#) [7301K38](#) [7306K36](#) [7310K36](#) [7314K36](#) [7506K4](#) [7592K6](#) [7691K14](#) [7700K1](#) [8396K108](#) [8824K14](#) [8828K13](#) [G2VX](#) [G3VX](#)
[PS83-121G](#) [A101MD9AB04](#) [A101SD9AB04](#) [A101SDCQ04](#) [A103SD9AQ04](#) [A107TZB04](#) [A123P32YZQ](#) [A123S1YZG](#) [A127S1YCQ](#) [1-](#)
[1825192-0](#) [A131S1YZQ](#) [A201SCWZB04](#) [A207SYCB04](#) [A208J61ZQ0004](#) [A221K12KAG](#) [A221S1YZQ](#) [A221T1TCQ](#) [A232K12KZQ](#)
[A232M1YCQ](#) [A323S1CWZQ](#) [A423S1CWZG-M8](#) [A423S1YZQ](#) [12149A-3V](#) [12156AX408](#) [12147AGKX679](#)