

2M801 Dual-Start ACME Threads



Ordering Guide for 2M801

Series	Shell Style	Service Class	Shell Size - Insert Arrg.	Contact Type	Alternate Position
2M801-0XX	-16	NF	6-7	P	A

*add "-501" to the suffix of Jam Nut version to include a Hex Nut instead of a Spanner Nut.

SERIES	
2M801-007	Plugs with Integral Backshell
2M801-008	Plugs with Rear Accessory Thread
2M801-009	Receptacle with Integral Backshell
2M801-010	Receptacle with Accessory Thread

SHELL STYLE 2M801-007 2M801-008	
-16	Plug with Anti-Decoupling Spring
-26	Self-Locking Plug with Ratchet Mechanism
SHELL STYLE 2M801-009 2M801-010	
-01	In-Line
-02	Square Flange
-07	Jam Nut*

SERVICE CLASS	
	Finish
C	Aluminum/Black Anodize (Non-Conductive)
M	Aluminum/Electroless Nickel
NF	Aluminum/Cadmium with Olive Drab Chromate
MT	Aluminum/Nickel-PTFE (Durmalon)
Z1	Stainless Steel/Passivated
ZM	Stainless Steel/Electroless Nickel
ZN	Aluminum/Zinc-Nickel w/ Olive Drab Chromate
ZNU	Aluminum/Zinc-Nickel with Black Chromate

SHELL SIZE - INSERT ARRANGEMENTS	
See Insert Arrangements on Pages 13-15	

CONTACTS	
P	Pin
S	Socket
A	Pin, less contacts
B	Socket, less contacts



KEYING		
	A°	B°
A	150°	210°
B	75°	210°
C	95°	230°
D	140°	275°
E	75°	275°
F	95°	210°

INSERT ARRANGEMENTS

Insert Arrg.	No. of Contacts				
	#23	#20	#20HD	#16	#12
5-3	3				
6-1				1	
6-4	4				
6-6	6				
6-7	7				
6-23			3		
7-1					1
7-10	10				
7-25			5		
8-2				2	
8-13	13				
8-28			8		
8-200	4	2			
9-4				4	
9-19	19				
9-200	4			2	
9-201	8	2			
9-210			10		
10-2					2
10-5				5	
10-26	26				

INSERT ARRANGEMENTS

Insert Arrg.	No. of Contacts				
	#23	#20	#20HD	#16	#12
10-200	12				1
10-201	4				2
10-202	8			2	
13-2					2
13-3					3
13-7				7	
13-37	37				
13-200	6				2
13-201	10				2
13-220			20		
16-5					5
16-12				12	
16-55	55				
16-235			35		
17-7					7
17-14				14	
17-85	85				
17-241			41		
21-12					12
21-22				22	
21-130	130				
21-269			69		

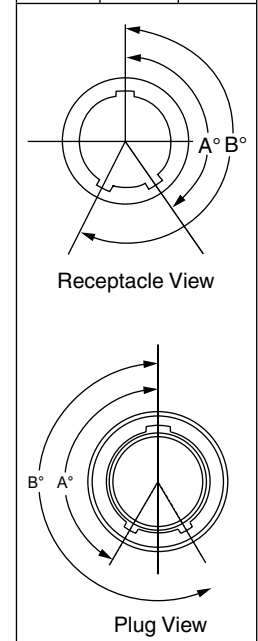

- Contacts & Tools
- 2M Specs
- 2M801
- 2M803
- 2M804
- 2M805
- 2M Filter & Accessories
- HD38999
- Micro-D
- Terrapin
- Nexus



**2M801-007-16
2M801-007-26**

**2M801-008-16
2M801-008-26**

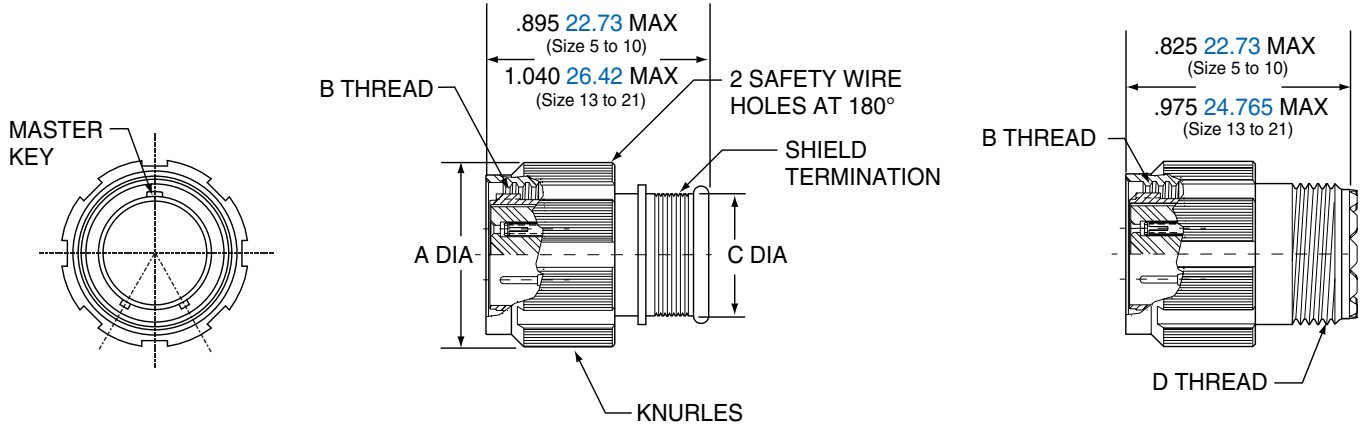

Shell Size	Style 16		Style 26		B Thread	C Dia.		D Thread UNEF-2A
	A Dia.		A Dia.			in.	mm.	
	in.	mm.	in.	mm.				
5	.545	13.84	.660	16.76	.3125-.05P-.1L-2B	.245	6.22	.2500-32
6	.610	15.49	.710	18.03	.3750-.05P-.1L-2B	.290	7.37	.3125-32
7	.695	17.65	.790	20.07	.4375-.05P-.1L-2B	.390	9.91	.4375-28
8	.750	19.05	.860	21.84	.5000-.05P-.1L-2B	.445	11.30	.5000-28
9	.810	20.57	.920	23.37	.5625-.05P-.1L-2B	.500	12.70	.5625-24
10	.890	22.61	.985	25.02	.6250-.05P-.1L-2B	.560	14.22	.6250-24
13	1.060	26.92	1.150	29.21	.8125-.1P-.2L-2B	.650	16.51	.6875-24
16	1.250	31.75	1.345	34.16	1.0000-.1P-.2L-2B	.805	20.45	.9375-20
17	1.310	33.27	1.400	35.56	1.0625-.1P-.2L-2B	.850	21.59	.9375-20
21	1.560	39.62	1.660	42.16	1.3125-.1P-.2L-2B	1.135	28.83	1.1875-18

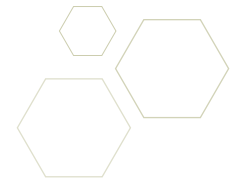

2M801 Dual-Start ACME Threads Jam Nut



2M801-009-07 and 2M801-010-07

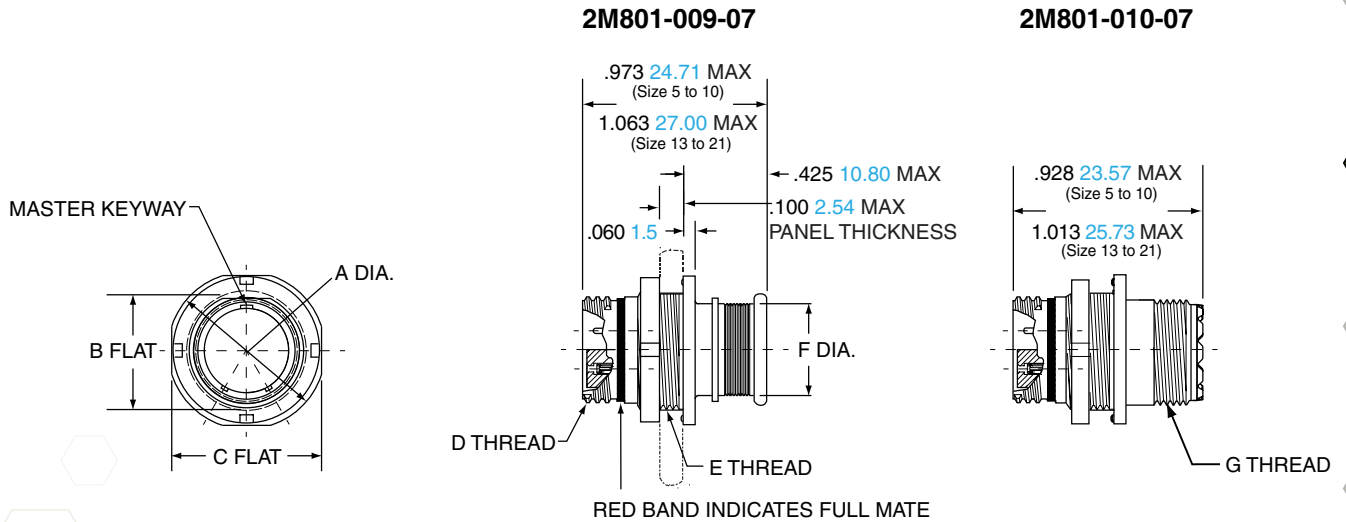

Shell Size	A Dia.		B Flat		C Flat		D Thread	E Thread	F Dia.		G Thread UNEF-2A
	in.	mm.	in.	mm.	in.	mm.			in.	mm.	
5	.575	14.61	.350	8.89	.545	13.84	.3125-.05P-.1L-2A	.3750-28 UN-2A	.245	6.22	.2500-32
6	.635	16.13	.410	10.41	.595	15.11	.3750-.05P-.1L-2A	.4375-28 UNEF-2A	.290	7.37	.3125-32
7	.755	19.18	.536	13.61	.723	18.36	.4375-.05P-.1L-2A	.5625-32 UN-2A	.390	9.91	.4375-28
8	.755	19.18	.536	13.61	.723	18.36	.5000-.05P-.1L-2A	.5625-32 UN-2A	.445	11.30	.5000-28
9	.830	21.08	.596	15.14	.790	20.07	.5625-.05P-.1L-2A	.6250-28 UN-2A	.500	12.70	.5625-24
10	.890	22.61	.658	16.71	.855	21.72	.6250-.05P-.1L-2A	.6875-28 UN-2A	.560	14.22	.6250-24
13	1.078	27.38	.845	21.46	1.044	26.52	.8125-.1P-.2L-2A	.8750-28 UN-2A	.650	16.51	.6875-24
16	1.264	32.11	1.022	25.96	1.230	31.24	1.0000-.1P-.2L-2A	1.0625-20 UN-2A	.805	20.45	.9375-20
17	1.325	33.66	1.096	27.84	1.290	32.77	1.0625-.1P-.2L-2A	1.125-28 UN-2A	.850	21.59	.9375-20
21	1.625	41.28	1.347	34.16	1.577	40.06	1.3125-.1P-.2L-2A	1.375-28 UN-2A	1.135	28.83	1.1875-18

JAM NUT PANEL CUTOUT

Shell Size	A Flat		B Dia.	
	in. ± .002	mm. ± 0.05	in. ± .002	mm. ± 0.05
5	.356	9.04	.385	9.78
6	.416	10.57	.447	11.35
7	.542	13.77	.572	14.53
8	.542	13.77	.572	14.53
9	.602	15.29	.635	16.13
10	.666	16.62	.697	17.70
13	.851	21.62	.885	22.48
16	1.028	26.11	1.075	27.31
17	1.102	27.99	1.135	28.83
21	1.354	34.39	1.385	35.18

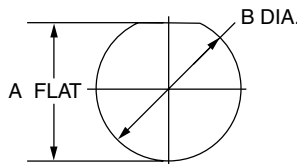

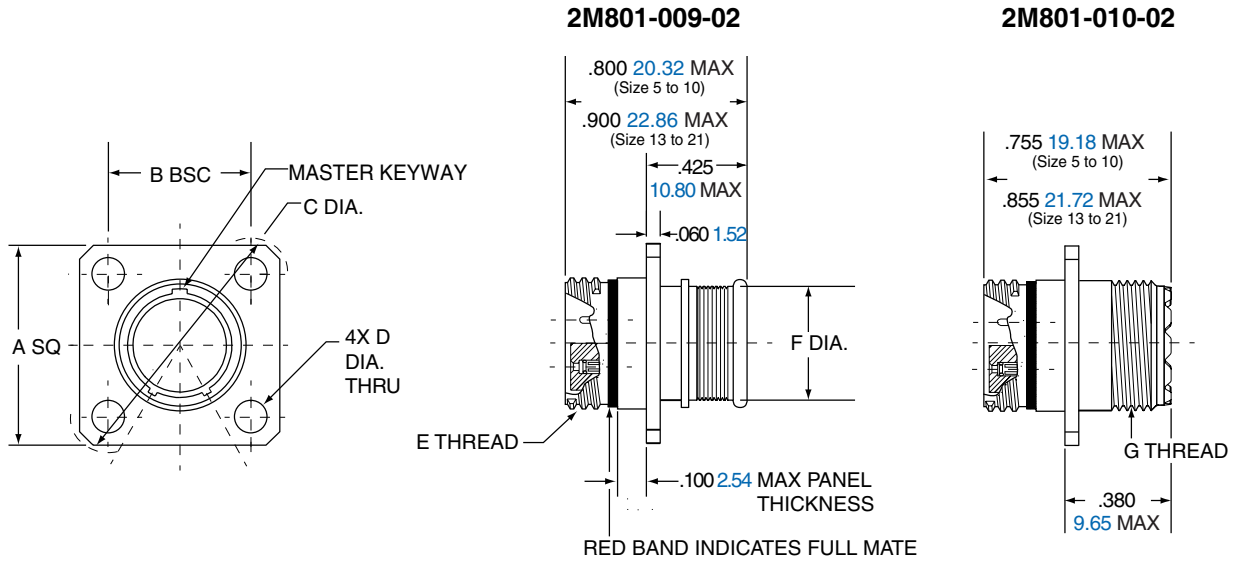

Shell Size	A		B BSC		C Dia.		D Dia.		E Thread	F Dia.		G Thread UNEF-2A
	in.	mm.	in.	mm.	in.	mm.	in. ± .003	mm. ± .08		in.	mm.	
5	.530	13.46	.363	9.22	.680	17.27	.093	2.36	.3125-.05P-.1L-2A	.245	6.22	.2500-32
6	.590	14.99	.423	10.74	.750	19.05	.093	2.36	.3750-.05P-.1L-2A	.290	7.37	.3125-32
7	.650	16.51	.483	12.27	.850	21.59	.093	2.36	.4375-.05P-.1L-2A	.390	9.91	.4375-28
8	.712	18.08	.545	13.84	.940	23.88	.093	2.36	.5000-.05P-.1L-2A	.445	11.30	.5000-28
9	.850	21.59	.607	15.42	1.125	28.58	.128	3.25	.5625-.05P-.1L-2A	.500	12.70	.5625-24
10	.890	22.61	.670	17.02	1.190	30.23	.128	3.25	.6250-.05P-.1L-2A	.560	14.22	.6250-24
13	1.030	26.16	.812	20.62	1.375	34.93	.128	3.25	.8125-.1P-.2L-2A	.650	16.51	.6875-24
16	1.219	30.96	.981	24.92	1.625	41.28	.128	3.25	1.0000-.1P-.2L-2A	.805	20.45	.9375-20
17	1.280	32.51	1.060	26.92	1.700	43.18	.128	3.25	1.0625-.1P-.2L-2A	.850	21.59	.9375-20
21	1.430	36.32	1.205	30.61	1.940	49.28	.128	3.25	1.3125-.1P-.2L-2A	1.135	28.83	1.1875-18

PANEL CUTOUT

Shell Size	A Dia.		B Dia.		C Dia.	
	in.	mm.	in.	mm.	in.	mm.
5	.330	8.38	.363	9.22	.093	2.36
6	.390	9.91	.423	10.74	.093	2.36
7	.450	11.43	.483	12.27	.093	2.36
8	.510	12.95	.545	13.84	.093	2.36
9	.575	14.61	.607	15.42	.128	3.25
10	.640	16.26	.670	17.02	.128	3.25
13	.825	20.96	.812	20.65	.128	3.25
16	1.015	25.78	.981	24.92	.128	3.25
17	1.075	27.31	1.060	26.92	.128	3.25
21	1.325	33.66	1.205	30.61	.128	3.25

2M801 Dual-Start ACME Threads In-Line



2M801-009-01 and 2M801-010-01

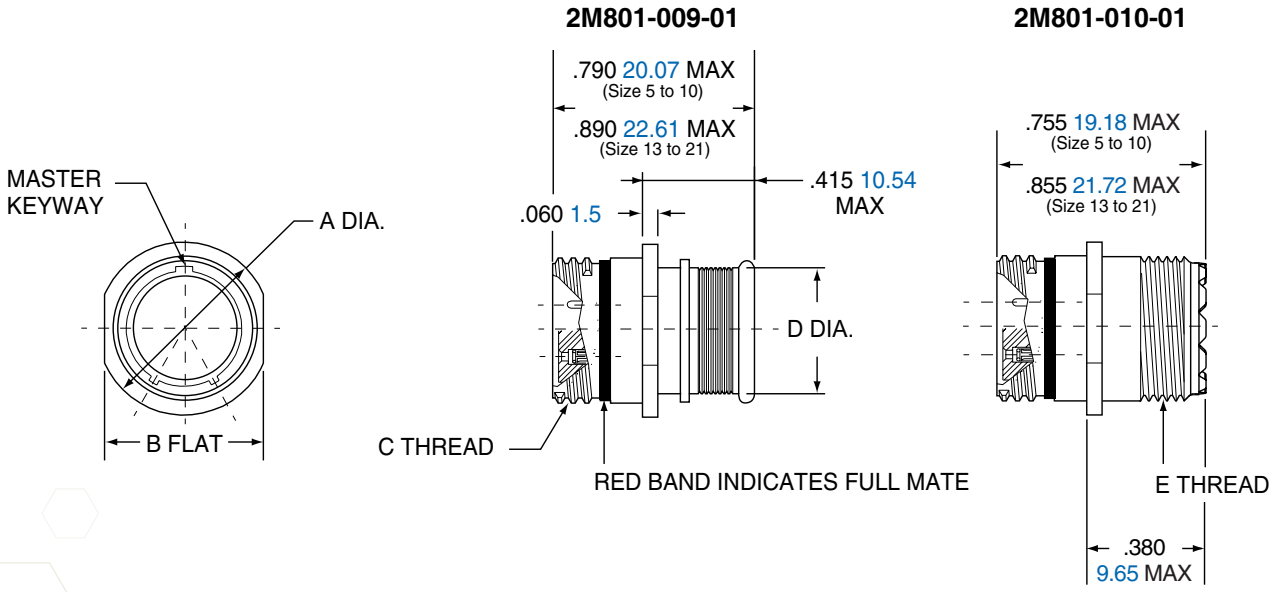

Shell Size	A Dia.		B Flat		C Thread	D Dia.		E Thread UNEF-2A
	in.	mm.	in.	mm.		in.	mm.	
5	.355	9.02	.325	8.13	.3125-.05P-.1L-2A	.245	6.22	.2500-32
6	.415	10.54	.385	9.78	.3750-.05P-.1L-2A	.290	7.37	.3125-32
7	.480	12.19	.445	11.30	.4375-.05P-.1L-2A	.390	9.91	.4375-28
8	.540	13.72	.510	12.95	.5000-.05P-.1L-2A	.445	11.30	.5000-28
9	.605	15.37	.575	14.61	.5625-.05P-.1L-2A	.500	12.70	.5625-24
10	.665	16.89	.635	16.13	.6250-.05P-.1L-2A	.560	14.22	.6250-24
13	.855	21.72	.825	20.96	.8125-.1P-.2L-2A	.650	16.51	.6875-24
16	1.040	26.42	1.010	25.65	1.0000-.1P-.2L-2A	.805	20.44	.9375-20
17	1.110	28.19	1.070	27.18	1.0625-.1P-.2L-2A	.850	21.59	.9375-20
21	1.405	35.69	1.385	35.18	1.3125-.1P-.2L-2A	1.135	28.83	1.1875-18

- Contacts & Tools
- 2M Specs
- 2M801**
- 2M803
- 2M804
- 2M805
- 2M Filter & Accessories
- HD38999
- Micro-D
- Terrapin
- Nexus

X-ON Electronics

Largest Supplier of Electrical and Electronic Components

Click to view similar products for [amphenol manufacturer](#):

Other Similar products are found below :

[JTPQ00RT-16-35P\(453\)](#) [CF-509621-29P](#) [BF8-1218-31SV-Y70](#) [TVP00RGW-23-6SA\(LC\)](#) [RNJ27CI1535P014](#) [10-553998-139](#) [10-507142-843](#) [GTS02R20-15P-025-116](#) [ACC02E28-51S-003-B30-LC](#) [TV06RL-13-35SD-LC](#) [TV06RL-13-35SD](#) [TV06RL-13-98SD-LC](#) [TV06RL-13-98SD](#) [TVP00RW-23-53AD](#) [100-007-213-002-001](#) [JT07RT-22-14PB-453](#) [10-037090-161](#) [10-541504-001](#) [10-580902-409](#) [TV97RW-9-9S\(S15\)](#) [TVPS00RGF-9-5P-LC](#) [TVPS00RGF-9-5PA-LC](#) [TV06RW-25-90AE](#) [97-3108B16S-5PW-417](#) [PT06J20-24SW](#) [97-3108B16S-4PY-417](#) [97-3108B16S-4PX-417](#) [97-3108B16S-5PY-417](#) [97-3108B16S-4PW-417](#) [CS-DSDMDB37MF-025](#) [97-3108B16S-5PZ-417](#) [TV06RW-25-46AE](#) [TVS07RF-21-16AA](#) [TVS07RF-21-39BA](#) [GTC02R32-17S-025-RDS](#) [GTC06-22-13SW](#) [BA-4116-50LD-Y103](#) [BACC63DB15-5PCH](#) [TVPS00RGF-23-6SC-LC](#) [GTC06-22-13SX-025-B30](#) [GTC06-22-13SW-025-B30](#) [GTC06-22-13SW-025-B30-LC](#) [GTC06-22-13SX-025-LC](#) [GTC06-22-13SY-025-B30-LC](#) [GTC06-22-13SY-025-LC](#) [97-3101A20-21P-958](#) [97-3106A18-3PX-958](#) [97-3106A18-3PY-958](#) [GTC06-36-7S-LC](#) [GTS08-36-22PZ-025-B30](#)