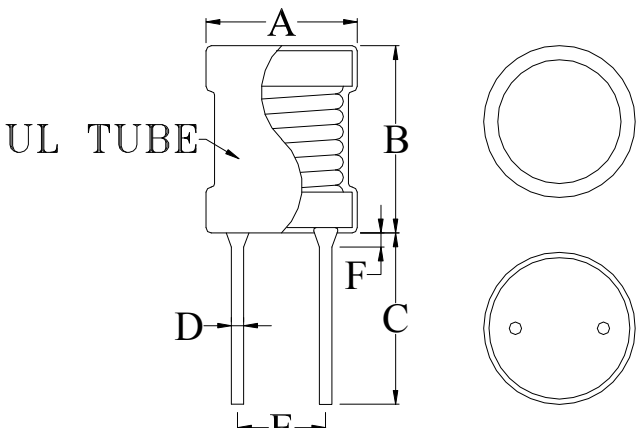

COMMODITY	PK CHOKE	SPEC NO.	SP-060824101
ITEM	COIL0608-0.22 Green		

(1) DIMENSION: (UNIT: mm)		DIM.	TOL.
	A	7.5	MAX.
	B	9.5	MAX.
	C	16	MIN.
	D	0.65	±0.05
	E	3.0	±0.5
	F	3.0	MAX.
	G		
	H		
	I		
	J		

(2) ELECTRICAL CHARACTERISTIC		TEST INSTRUMENTS.
INDUCTANCE	220 ± 10% μ H	<input checked="" type="checkbox"/> AGILENT 4294A Precision Impedance Analyzer. <input type="checkbox"/> AGILENT 4285A Precision L.C.R. Meter. <input type="checkbox"/> HP-4286A RF L.C.R. Meter.
TEST FREQUENCY	1 KHz	<input type="checkbox"/> ZENTECH 3302 Automatic Components Analyzer. <input type="checkbox"/> ZENTECH 101 L.C.R. Meter.
TEST VOLT	0.25 V	<input type="checkbox"/> WAYNE KERR 6420 Precision Impedance Analyzer. <input checked="" type="checkbox"/> ZENTECH 1320 BIAS CURRENT. <input checked="" type="checkbox"/> ZENTECH 502AC Resistance Merter.
RDC	870 (max) m Ω	<input type="checkbox"/> ADEX AX-1155B DC Low Ohm Meter.
Isat *1	0.7 (max) A	
Irms *2	0.6 (max) A	

REMARK :
 1. Inductance drop = 10% typ at IDC.

X-ON Electronics

Largest Supplier of Electrical and Electronic Components

Click to view similar products for [Fixed Inductors](#) category:

Click to view products by [Ferrocore](#) manufacturer:

Other Similar products are found below :

[MLZ1608M6R8WTD25](#) [MLZ1608N6R8LT000](#) [MLZ1608N3R3LTD25](#) [MLZ1608N3R3LT000](#) [MLZ1608N150LT000](#)
[MLZ1608M150WTD25](#) [MLZ1608M3R3WTD25](#) [MLZ1608M3R3WT000](#) [MLZ1608M150WT000](#) [MLZ1608A1R5WT000](#)
[MLZ1608N1R5LT000](#) [B82432C1333K000](#) [PCMB053T-1R0MS](#) [PCMB053T-1R5MS](#) [PCMB104T-1R5MS](#) [CR32NP-100KC](#) [CR32NP-151KC](#) [CR32NP-180KC](#) [CR32NP-181KC](#) [CR32NP-1R5MC](#) [CR32NP-390KC](#) [CR32NP-3R9MC](#) [CR32NP-680KC](#) [CR32NP-820KC](#)
[CR32NP-8R2MC](#) [CR43NP-390KC](#) [CR43NP-560KC](#) [CR43NP-680KC](#) [CR54NP-181KC](#) [CR54NP-470LC](#) [CR54NP-820KC](#) [CR54NP-8R5MC](#)
[MGDQ4-00004-P](#) [MGDU1-00016-P](#) [MHL1ECTTP18NJ](#) [MHL1JCTTD12NJ](#) [PE-51506NL](#) [PE-53601NL](#) [PE-53630NL](#) [PE-53824SNLT](#) [PE-62892NL](#) [PE-92100NL](#) [PG0434.801NLT](#) [PG0936.113NLT](#) [PM06-2N7](#) [PM06-39NJ](#) [HC2LP-R47-R](#) [HC2-R47-R](#) [HC3-2R2-R](#) [HC8-1R2-R](#)