

## COUNTER click

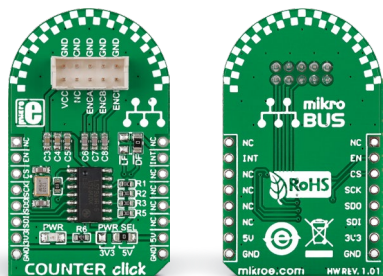

### 1. Introduction

Counter click carries an **LS7366R** quadrature counter. The top of the board has a pinout for interfacing with incremental encoders. The interface has ENCA and ENCB pins, along with ENCI, which is a programmable index. On the other side, Counter click communicates with the target board microcontroller through the mikroBUS™ SPI interface [CSK, MISO, MOSI], plus enable [CNT EN] and interrupt [LFLAG or DFLAG] pins. The board can use either a 3.3V or a 5V power supply.

### 2. Soldering the headers

Before using your click board™, make sure to solder 1x8 male headers to both left and right side of the board. Two 1x8 male headers are included with the board in the package.

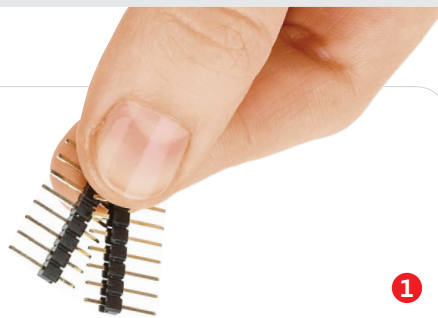

1

2

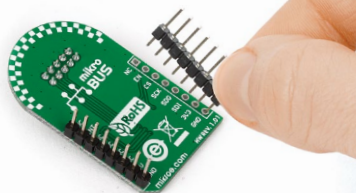

Turn the board upside down so that the bottom side is facing you upwards. Place shorter pins of the header into the appropriate soldering pads.

3

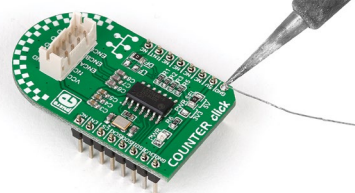

Turn the board upward again. Make sure to align the headers so that they are perpendicular to the board, then solder the pins carefully.

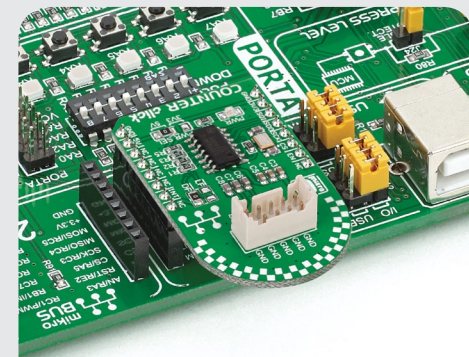

### 4. Essential features

Incremental encoders output A and B pulses which are out of phase to each other, ideally by 90°. The **LS7366R CMOS** counter takes these signals as inputs. The decoded input is then used for non-quadrature, up/down, free running counting [the IC has many counting modes]. Applications include measurement of the direction and RPM of DC motor shafts. This data can be used for monitoring and ensuring the proper operation of shafts in industrial, robotic and a number of other domains. The chip has multiple operating modes.

### 3. Plugging the board in

Once you have soldered the headers your board is ready to be placed into the desired mikroBUS™ socket. Make sure to align the cut in the lower-right part of the board with the markings on the silkscreen at the mikroBUS™ socket. If all the pins are aligned correctly, push the board all the way into the socket.

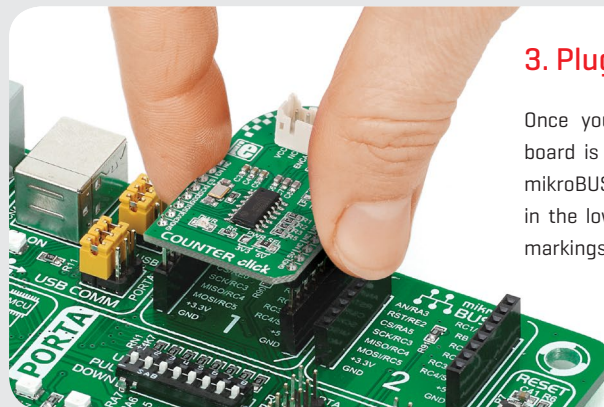

**click**  
BOARDS™  
[www.mikroe.com](http://www.mikroe.com)



Counter click Manual v1.01



010000089408

## 5. Schematic

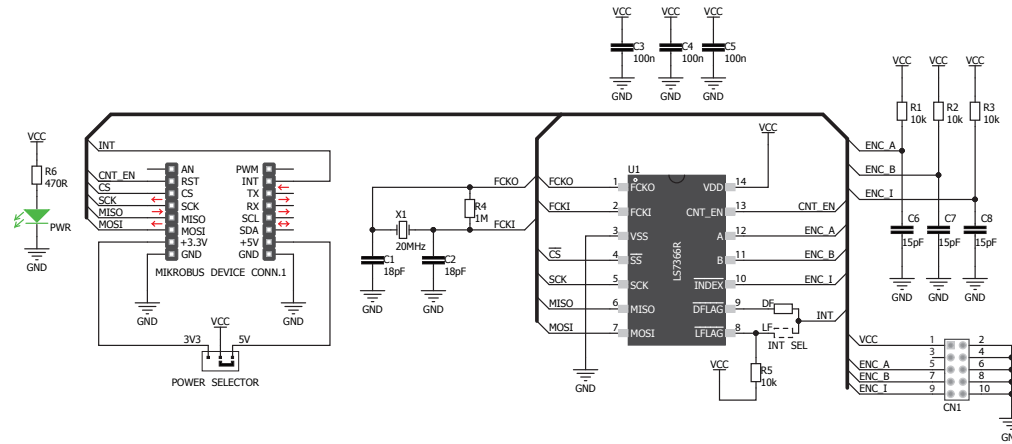

## 6. Dimensions

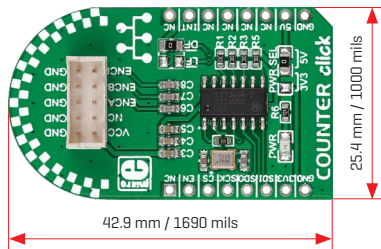

	mm	mils
LENGTH	42.9	1690
WIDTH	25.4	1000
HEIGHT*	3.9	154

\* without headers

## 7. SMD jumpers

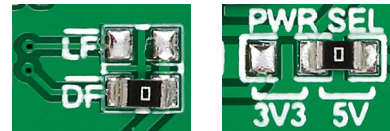

Counter click has two SMD jumpers (zero ohm resistor). One lets you switch between a 3.3V or a 5V power supply. The other is for setting the interrupt as LFLAG (open drain latched output) or DFLAG (push-pull output).

## 8. Code examples

Once you have done all the necessary preparations, it's time to get your click board™ up and running. We have provided examples for mikroC™, mikroBasic™ and mikroPascal™ compilers on our **Libstock** website. Just download them and you are ready to start.



## 9. Support

MikroElektronika offers **free tech support** [[www.mikroe.com/support](http://www.mikroe.com/support)] until the end of the product's lifetime, so if something goes wrong, we're ready and willing to help!



## 10. Disclaimer

MikroElektronika assumes no responsibility or liability for any errors or inaccuracies that may appear in the present document. Specification and information contained in the present schematic are subject to change at any time without notice.

Copyright © 2015 MikroElektronika.  
All rights reserved.

## X-ON Electronics

Largest Supplier of Electrical and Electronic Components

*Click to view similar products for [Development Boards & Kits - Wireless](#) category:*

*Click to view products by [MikroElektronika](#) manufacturer:*

Other Similar products are found below :

[13237ADC-SFTW](#) [13237ADC-BDM](#) [SLWRB4542B](#) [SLWRB4546A](#) [CC-WMX51-LX](#) [TWR-13237](#) [TWR-13237-KIT](#) [109110001](#)  
[DA14585-00VVDB-P](#) [MKR MOTOR CARRIER](#) [AC164159](#) [RD-88MW322-R0](#) [RD-88MW320-R0](#) [FMC PCAM ADAPTER](#) [BLE 4 CLICK](#)  
[C METER CLICK](#) [HALL CURRENT CLICK](#) [COLOR 3 CLICK](#) [COMPASS 2 CLICK](#) [COMPASS CLICK](#) [HDC1000 CLICK](#) [RELAY](#)  
[CLICK](#) [RIVERDI CLICK](#) [CUGSM113#UFL](#) [R METER CLICK](#) [MATRIX G CLICK](#) [MATRIX RGB CLICK](#) [3D MOTION CLICK](#) [3G](#)  
[SARA CLICK](#) [TDGL012](#) [4-20MA R CLICK](#) [4-20MA T CLICK](#) [THERMO CLICK](#) [MCP2003B CLICK](#) [EXPAND 3 CLICK](#) [MCP2542](#)  
[CLICK](#) [MCP25625 CLICK](#) [ATA663211 CLICK](#) [ATA8520-EK3-E](#) [TOUCHKEY CLICK](#) [MICROSD CLICK](#) [TRF CLICK](#) [BUTTON R](#)  
[CLICK](#) [IR ECLIPSE CLICK](#) [IR THERMO 2 CLICK](#) [UNIQUE ID CLICK](#) [UV 2 CLICK](#) [CAN-SPI CLICK 3.3V](#) [CAN-SPI CLICK 5V](#) [CAP](#)  
[EXTEND CLICK](#)