

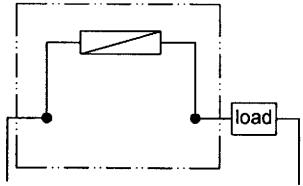





Rating	30A 32V DC	<p style="text-align: center;">Circuit Diagram</p> 
Insulation Resistance	DC 500V 100MΩ Min	
Dielectric Strength	AC 1000V 1 minute	
Fuse Type	BLADE FUSE	

Material:
 Body: Black, PVC(T105°C)
 Waterproof. IPX5 

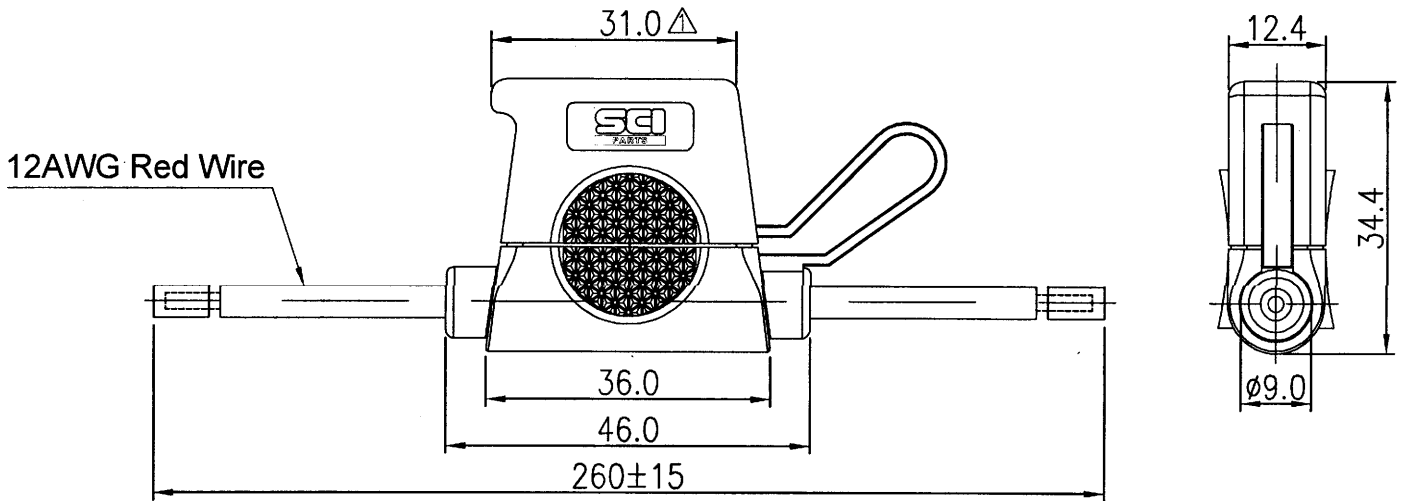
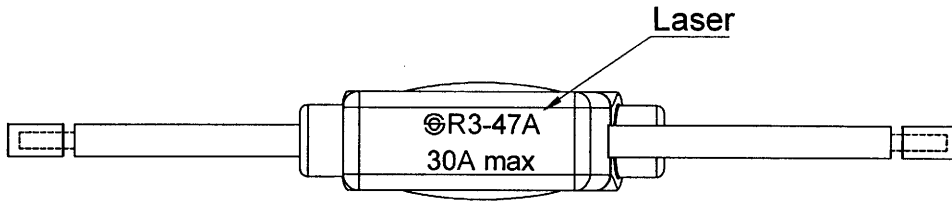

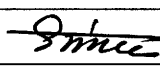
Tolerance ±0.5 except otherwise specified

07/13/'18	柳新強	依客人要求增加標示防水等級IPX5					
10/31/'16	柳新強	為便於打開上蓋設計變更，尺寸27改為31					
Date	Name	Description			NO		
Drawn	Checked	Approved	SCI BOM No.	1310220	Model Name	In-Line Fuse Holder	
柳新強			Customer No.		Model No.	R3-47A	
07/13/'18		7/13-18	Unit	mm	 Shin Chin Industrial Co., Ltd.		
						Rev.	X2

X-ON Electronics

Largest Supplier of Electrical and Electronic Components

Click to view similar products for [Fuse Holder](#) category:

Click to view products by [SCI manufacturer](#):

Other Similar products are found below :

[570-290-741P40](#) [570-290-751P40](#) [0031.1351.01](#) [020417G](#) [020418E](#) [80910030](#) [8601.2020](#) [9-3557-GP REV A](#) [15600-08-10](#) [BK1-HTC-45M](#)
[BK/FHN19G](#) [BK/HJM-HH](#) [BK/HKP-CCHH](#) [BK/HKP-E-CC](#) [BK/HKP-E-HH](#) [BK/HKP-EH-HH](#) [BK/HKP-U-HH](#) [BK/HTJ-LES-FUSE](#)
[HMG-241](#) [2086-1](#) [2193](#) [RTMF-SC](#) [2602](#) [2650](#) [FHN31G1](#) [G4PB8](#) [2660](#) [2799](#) [CQ-209V](#) [345621A](#) [3794](#) [4202](#) [4408](#) [4413](#) [4423](#) [4482](#)
[4532](#) [4537](#) [TSD1404-12](#) [BK/FHN31G1](#) [BK/HKP-H-CC](#) [BK/HKP-JQ-BB](#) [BK/HKP-JQW-BB](#) [BK/HKP-N-HH](#) [BK/HKP-S-CC](#) [BK/HKP-W-](#)
[BBHH](#) [BP/HHS](#) [BPHHU](#) [55900008011](#) [C1933](#)