



LED HIGH POWER

M03 CoB Product Series

Data Sheet

Created Date: 09 / 18 / 2013
Revision: 7.0, 04 / 01 / 2014



LED HIGH POWER M03 Product Series

1. Description

The LiteON CoB Product series is a revolutionary, energy efficient and ultra-compact new light source, combining the lifetime and reliability advantages of Light Emitting Diodes with the brightness of conventional lighting. It gives you total design freedom and unmatched brightness, creating a new opportunities for solid state lighting to displace conventional lighting technologies.

1.1 Features

- Compact high flux density light source
- Uniform high quality illumination
- Streamlined thermal path
- MacAdam compliant binning structure
More energy efficient than incandescent, halogen and fluorescent lamps
- Instant light with unlimited dimming
- RoHS compliant and Pb free

1.2 Benefits Features

- Enhanced optical control
- Clean white light without pixilation
- Uniform consistent white light
- Significantly reduced thermal resistance and increased operating temperatures
- Lower operating costs
- Reduced maintenance costs
- ESD rating is 8KV in HBM

1.3 Naming Rule

L T PL - M 0 3 6 X X Z S X X - X X
Code1 Code2 Code3 Code4 Code5 Code6

Code 1: Product Line

PL: High Power LED.

Code 2: Package Type/Platform

M03: Ceramic substrate with 16x16mm square.

Code 3: Light Emitting Surface

6: 9mm excluding dam

Code 4: Product Series

14: 14 Series
18: 18 Series
22: 22 Series

Code5: Color Temperature

27: 2700K at 85degC
30: 3000K at 85degC
40: 4000K at 85degC
50: 5000K at 85degC
57: 5700K at 85degC
Note: The Color Temperature follow ANSI C78.377A Doc.

Code6: Hue Bin by MacAdam Ellipses Step

T0: 3-Step Mac Adam Ellipse+Main Lumen Bin (2700K~4000K)
S1: 5-Step Mac Adam Ellipse/ANSI+Full Lumen Bins (2700K~4000K)
F1: 5-Step Mac Adam Ellipse+Full Lumen Bins (5000K~6500K)
S1: ANSI+Full Lumen Bins (5000K~6500K)

LED HIGH POWER M03 Product Series

1.4 Product List

Part Number	Product Series	CCT	CRI	Color Bin			Lumen Bin	
				3SDCM	5SDCM	ANSI	-8%~+8%	-15%~+15%
LTPL-M03614ZS27-T0	14	2700K	80	☆			☆	
LTPL-M03614ZS27-S1	14	2700K	80		☆	☆		☆
LTPL-M03614ZS30-T0	14	3000K	80	☆			☆	
LTPL-M03614ZS30-S1	14	3000K	80		☆	☆		☆
LTPL-M03614ZS40-T0	14	4000K	80	☆			☆	
LTPL-M03614ZS40-S1	14	4000K	80		☆	☆		☆
LTPL-M03614ZS50-F1	14	5000K	80		☆			☆
LTPL-M03614ZS50-S1	14	5000K	80			☆		☆
LTPL-M03614ZS57-F1	14	5700K	80		☆			☆
LTPL-M03614ZS57-S1	14	5700K	80			☆		☆
LTPL-M03618ZS27-T0	18	2700K	80	☆			☆	
LTPL-M03618ZS27-S1	18	2700K	80		☆	☆		☆
LTPL-M03618ZS30-T0	18	3000K	80	☆			☆	
LTPL-M03618ZS30-S1	18	3000K	80		☆	☆		☆
LTPL-M03618ZS40-T0	18	4000K	80	☆			☆	
LTPL-M03618ZS40-S1	18	4000K	80		☆	☆		☆
LTPL-M03618ZS50-F1	18	5000K	80		☆			☆
LTPL-M03618ZS50-S1	18	5000K	80			☆		☆
LTPL-M03618ZS57-F1	18	5700K	80		☆			☆
LTPL-M03618ZS57-S1	18	5700K	80			☆		☆
LTPL-M03622ZS27-T0	22	2700K	80	☆			☆	
LTPL-M03622ZS27-S1	22	2700K	80		☆	☆		☆
LTPL-M03622ZS30-T0	22	3000K	80	☆			☆	
LTPL-M03622ZS30-S1	22	3000K	80		☆	☆		☆
LTPL-M03622ZS40-T0	22	4000K	80	☆			☆	
LTPL-M03622ZS40-S1	22	4000K	80		☆	☆		☆
LTPL-M03622ZS50-F1	22	5000K	80		☆			☆
LTPL-M03622ZS50-S1	22	5000K	80			☆		☆
LTPL-M03622ZS57-F1	22	5700K	80		☆			☆
LTPL-M03622ZS57-S1	22	5700K	80			☆		☆

LED HIGH POWER M03 Product Series

2. Outline Dimensions

2.1 Form Factor of M036 series CoB

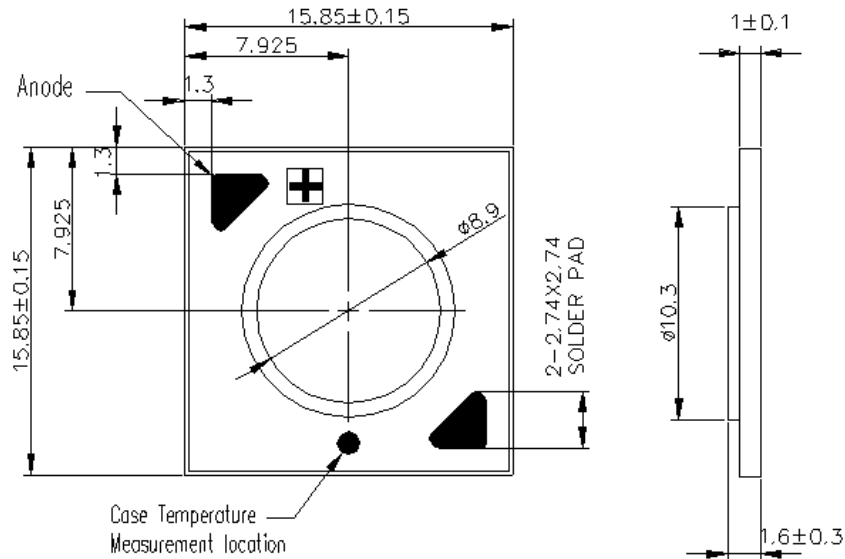

Notes

1. All dimensions are in millimeters.
2. Tolerance is ± 0.3 mm unless otherwise noted.
3. LED of equivalent circuit means all series/parallel in CoB package.

2.2 Internal Equivalent Circuit

14 Series Product

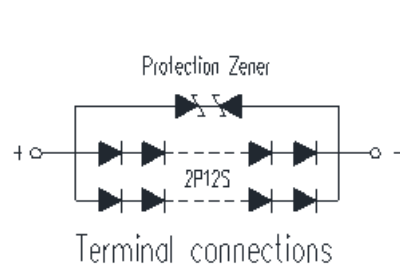

18 Series & 22 Series Product

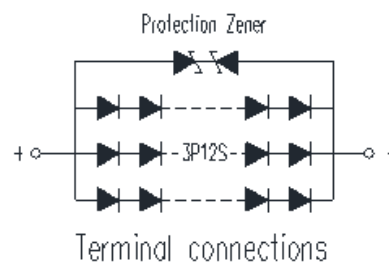

LED HIGH POWER M03 Product Series

3. Absolute Maximum Ratings at Ta=25°C

Parameter	Symbol	Product Series	Rating	Unit
Power Dissipation	P _O	14	16	W
		18	21	
		22	24	
Forward Current	I _F	14	400	mA
		18	500	
		22	600	
Junction Temperature		T _J	125	°C
Thermal Resistance, Junction-Case	R _{th, J-C}	14	1.7	°C/W
		18	1.4	
		22	1.2	
Operating Temperature Range		T _{opr}	-40 to 85	°C
Storage Temperature Range		T _{stg}	-40 to 100	°C
Breakdown Voltage(DC)		V _B	2.25	KV
Electrostatic Discharge		ESD	8	KV

Notes

1. The pulse mode condition is 1/10 duty cycle with 100 msec pulse width.
2. Forbid to be operated at reverse voltage condition.
3. ESD spec is reference to AEC-Q101-001 HBM.
4. The unit of R_{th} is °C/W electrical.
5. The M03 CoB is recommended soldering temperature under 350degC and could not over 3.5sec.

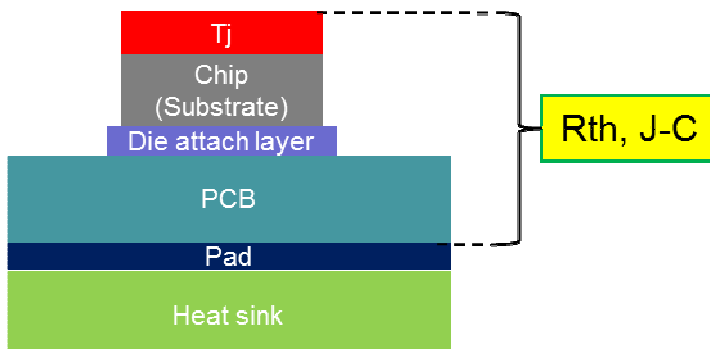

LED HIGH POWER M03 Product Series

4. Electro-Optical Characteristics

4.1 Typical Performance

■ 14 Series Product

Dominant CCT	Product Series	Current (mA)	V _F (V) @ 25°C	Flux(lm) @ 25°C	V _F (V) @ 85°C	Flux(lm) @ 85°C	Eff.(lm/W) @ 25°C	Eff.(lm/W) @ 85°C
2700K	14	350	38.5	1546	37.7	1391	115	105
3000K	14	350	38.5	1610	37.7	1448	119	110
4000K	14	350	38.5	1707	37.7	1535	127	116
5000K	14	350	38.5	1723	37.7	1550	128	118
5700K	14	350	38.5	1691	37.7	1521	126	115

■ 18 Series Product

Dominant CCT	Product Series	Current (mA)	V _F (V) @ 25°C	Flux(lm) @ 25°C	V _F (V) @ 85°C	Flux(lm) @ 85°C	Eff.(lm/W) @ 25°C	Eff.(lm/W) @ 85°C
2700K	18	450	39.5	1934	38.6	1740	109	100
3000K	18	450	39.5	2014	38.6	1812	113	104
4000K	18	450	39.5	2135	38.6	1921	120	110
5000K	18	450	39.5	2155	38.6	1939	121	112
5700K	18	450	39.5	2116	38.6	1904	119	109

■ 22 Series Product

Dominant CCT	Product Series	Current (mA)	V _F (V) @ 25°C	Flux(lm) @ 25°C	V _F (V) @ 85°C	Flux(lm) @ 85°C	Eff.(lm/W) @ 25°C	Eff.(lm/W) @ 85°C
2700K	22	500	38.3	2284	37.5	2055	119	110
3000K	22	500	38.3	2360	37.5	2123	123	113
4000K	22	500	38.3	2500	37.5	2249	131	120
5000K	22	500	38.3	2541	37.5	2286	133	122
5700K	22	500	38.3	2492	37.5	2242	130	120

Notes

1. All of V_F value are typical, the real bin range please refer page 14 "V_F Binning Parameter".
2. All of flux value are typical, the real bin range please refer page 13 "Flux Binning Parameter".
3. Tolerance of flux is ±7%, tolerance of CCX/CCY is ±0.007, tolerance of CRI is ±2, and tolerance of V_F is ±3%.
4. Typical viewing angle is 120deg.

LED HIGH POWER M03 Product Series

4.2 Forward Current vs. Lumen and Voltage

■ 14 Series Product

Current (mA)	V _F (V)	Flux (lm)				
		2700K	3000K	4000K	5000K	5700K
		CRI>80	CRI>80	CRI>80	CRI>80	CRI>80
50	33.0	355	374	390	394	386
75	33.5	457	475	506	508	504
100	33.9	553	586	613	625	607
125	34.4	657	687	732	741	726
150	34.9	766	794	847	856	834
175	35.3	857	899	955	956	944
200	35.8	962	991	1067	1064	1058
225	36.3	1073	1103	1168	1181	1164
250	36.7	1172	1221	1293	1311	1282
275	37.2	1271	1303	1398	1410	1369
300	37.6	1347	1415	1516	1524	1501
325	38.1	1457	1504	1589	1604	1583
350	38.5	1546	1610	1707	1723	1691
375	38.9	1642	1687	1786	1807	1774
400	39.3	1711	1782	1893	1920	1866

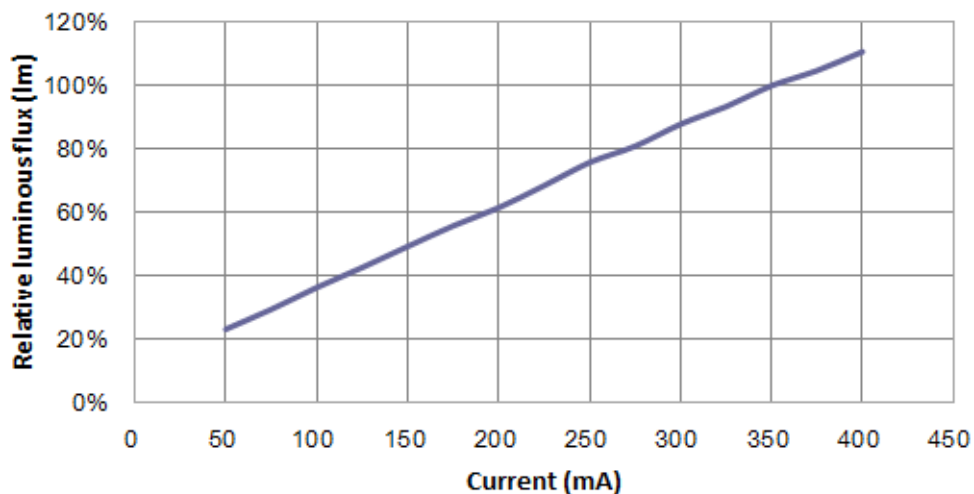

LED HIGH POWER M03 Product Series

■ 18 Series Product

Current (mA)	V _F (V)	Flux (lm)				
		2700K	3000K	4000K	5000K	5700K
		CRI>80	CRI>80	CRI>80	CRI>80	CRI>80
150	34.6	759	778	834	840	825
175	35.2	859	902	962	966	953
200	35.8	983	1010	1075	1096	1077
225	36.2	1089	1128	1190	1218	1194
250	36.6	1179	1236	1316	1332	1286
275	37	1285	1346	1420	1423	1423
300	37.4	1400	1440	1534	1540	1512
325	37.7	1468	1539	1652	1652	1608
350	38.1	1574	1638	1725	1748	1712
375	38.5	1676	1749	1836	1849	1830
400	38.9	1778	1826	1971	1968	1941
425	39.2	1843	1912	2029	2064	2045
450	39.5	1934	2014	2135	2155	2116
475	39.9	2013	2090	2220	2255	2229
500	40.3	2097	2180	2325	2345	2307

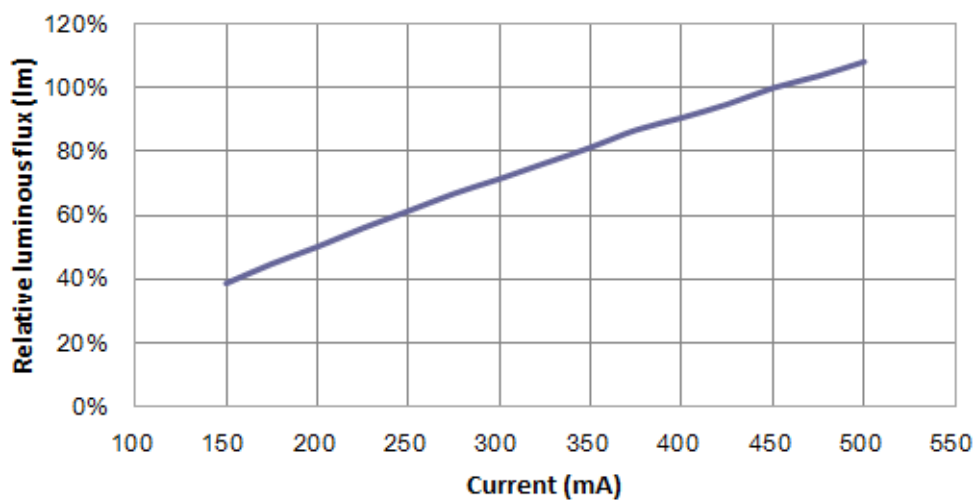

LED HIGH POWER M03 Product Series

■ 22 Series Product

Current (mA)	V _F (V)	Flux (lm)				
		2700K	3000K	4000K	5000K	5700K
		CRI>80	CRI>80	CRI>80	CRI>80	CRI>80
250	35.2	1248	1311	1381	1393	1366
275	35.6	1369	1423	1490	1514	1505
300	35.9	1483	1538	1610	1656	1606
325	36.2	1530	1629	1704	1715	1686
350	36.5	1676	1748	1853	1868	1849
375	36.8	1772	1867	1953	1986	1945
400	37.1	1872	1977	2087	2090	2044
425	37.4	1980	2086	2185	2199	2150
450	37.7	2096	2190	2289	2324	2291
475	38	2161	2267	2398	2426	2391
500	38.3	2284	2360	2500	2541	2492
525	38.6	2378	2473	2594	2627	2589
550	38.9	2448	2550	2703	2728	2678
575	39.1	2555	2661	2801	2803	2768
600	39.4	2627	2742	2877	2893	2846

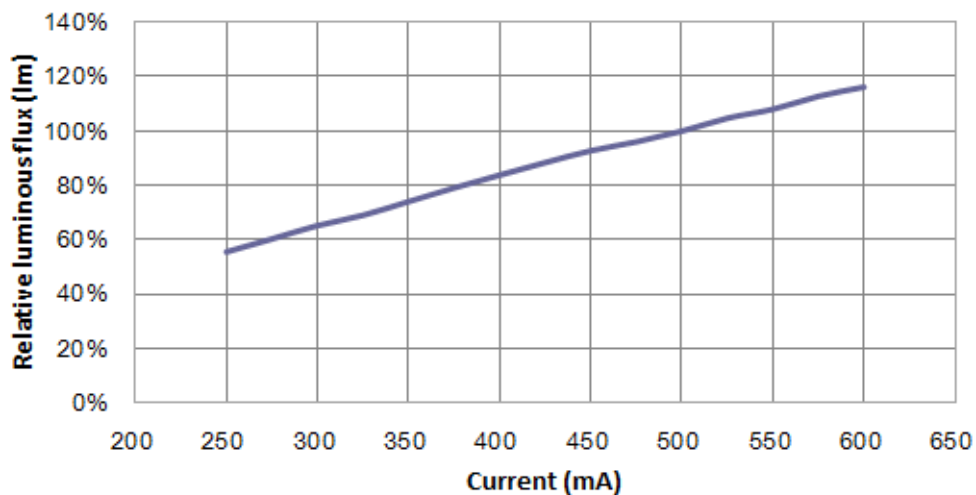

LED HIGH POWER M03 Product Series

4.3 Relative Spectral Power Distribution at Typical Current

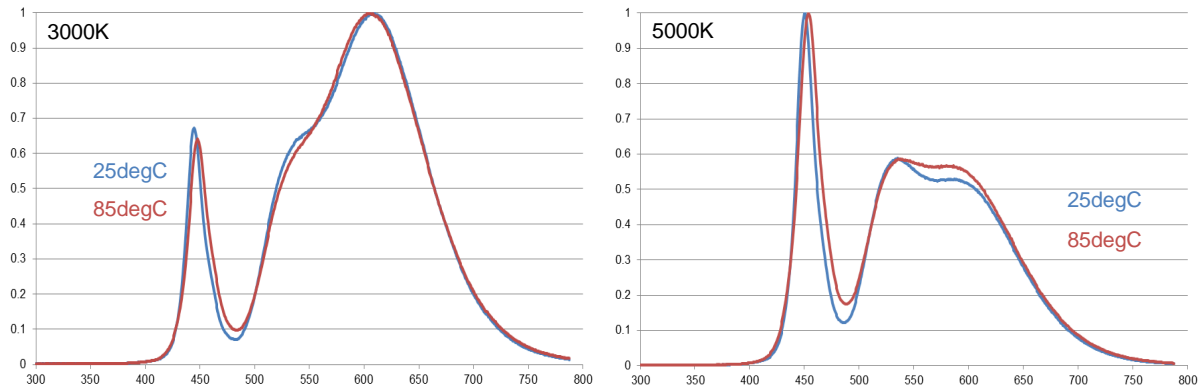

4.4 Radiation Characteristics

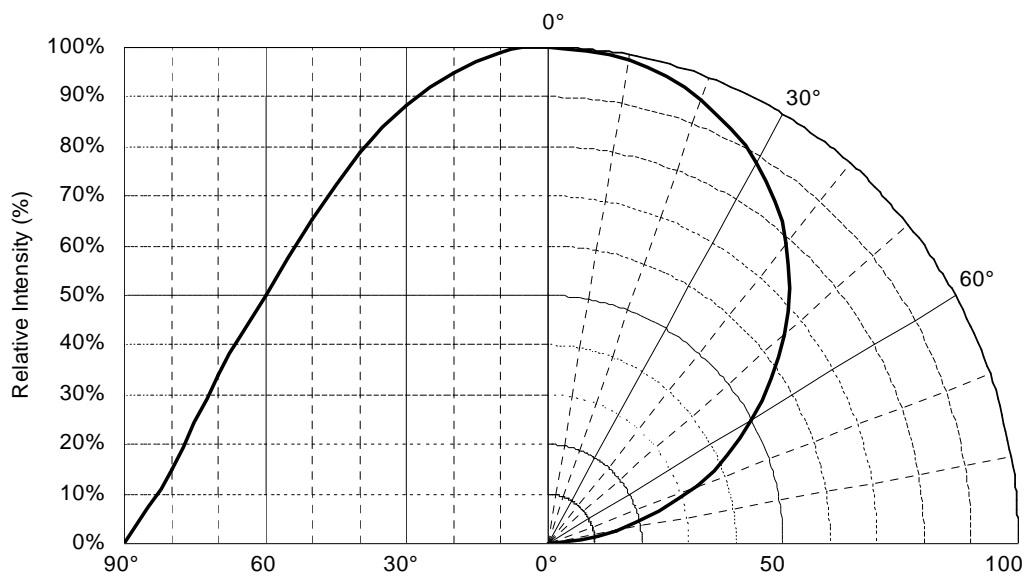

**LED HIGH POWER
M03 Product Series**

4.5 Forward Current vs. Forward Voltage

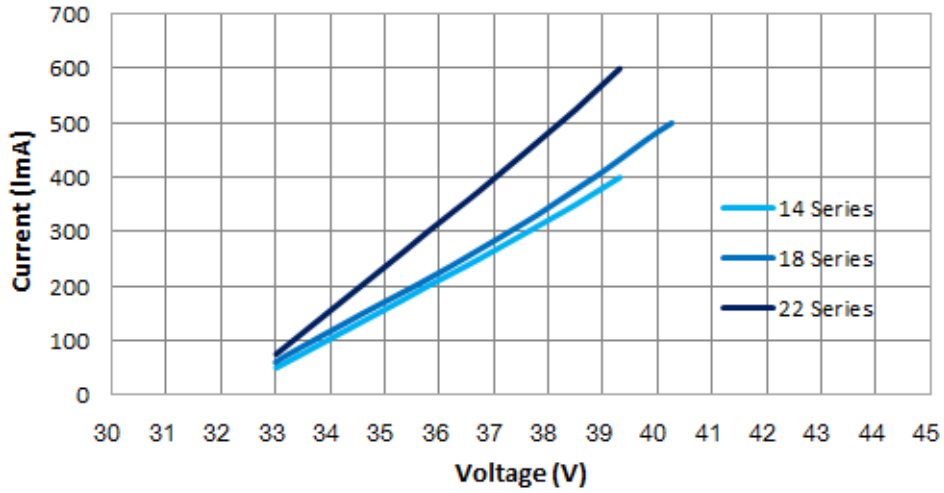

LED HIGH POWER M03 Product Series

4.6 Forward Voltage vs. Junction Temperature

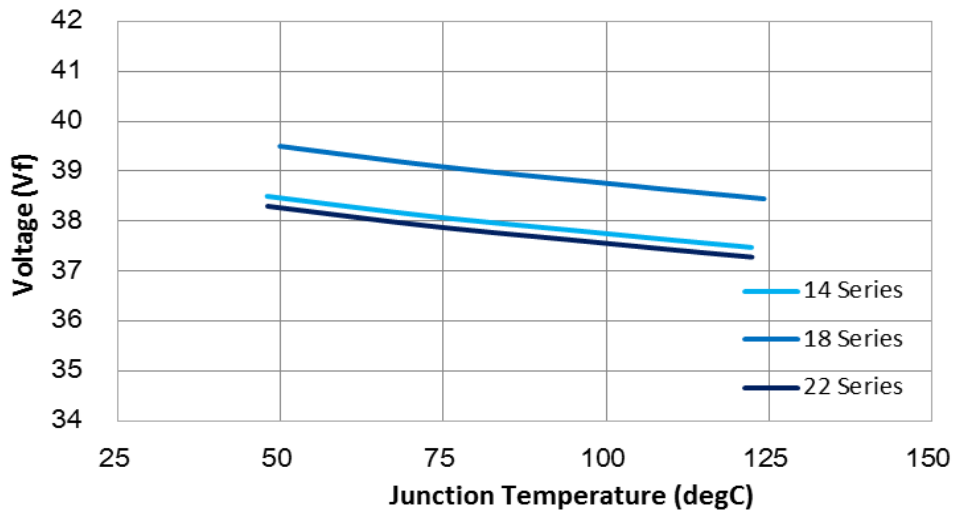

Forward Voltage vs. Junction Temperature

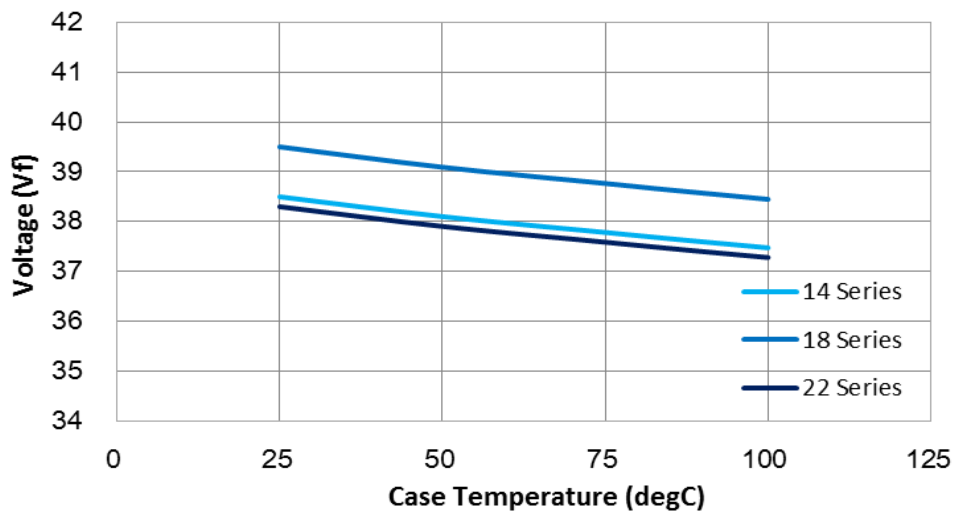

LED HIGH POWER M03 Product Series

4.7 Relative Intensity vs. Junction Temperature

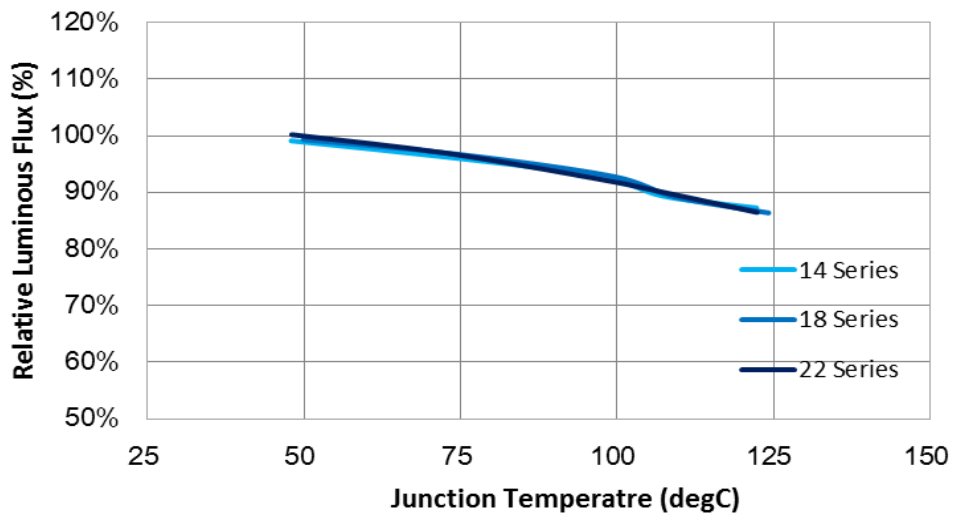

Relative Intensity vs. Case Temperature

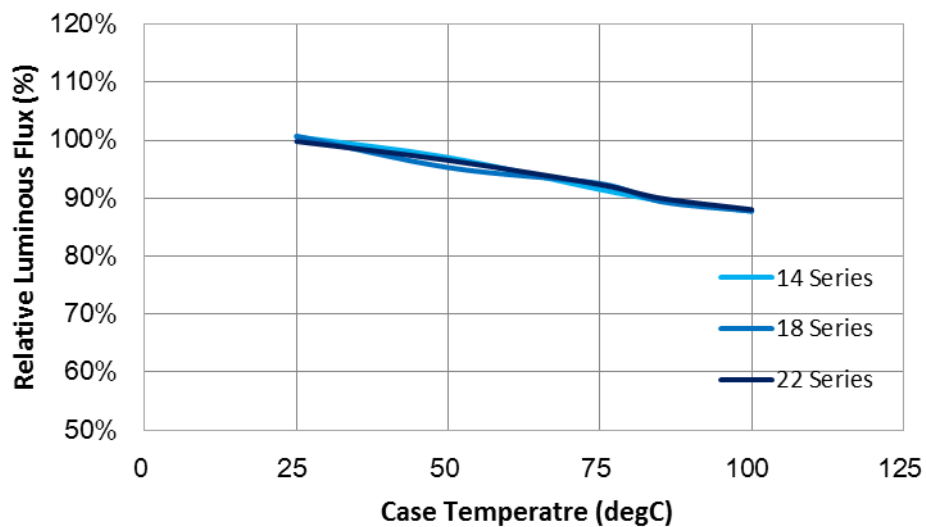

LED HIGH POWER M03 Product Series

4.8 Forward Current Degrading Curve

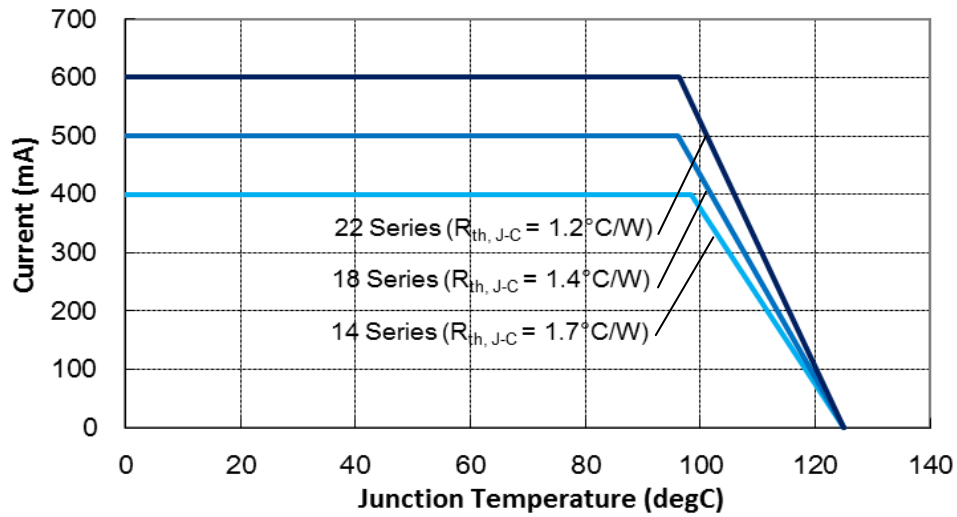

LED HIGH POWER M03 Product Series

5. CoB Binning Definition

Flux Binning Parameter (25degC)

Lumen CODE List of M03 Series Product			
Parameter	Code	Unit	Lumen
Luminous Flux	I	lm	1345
	J		1455
	K		1570
	L		1695
	M		1830
	N		1975
	O		2130
	P		2300
	Q		2485
	R		2680
	S		2890

Example of M03 Series Product Bin (2700K 14 series)

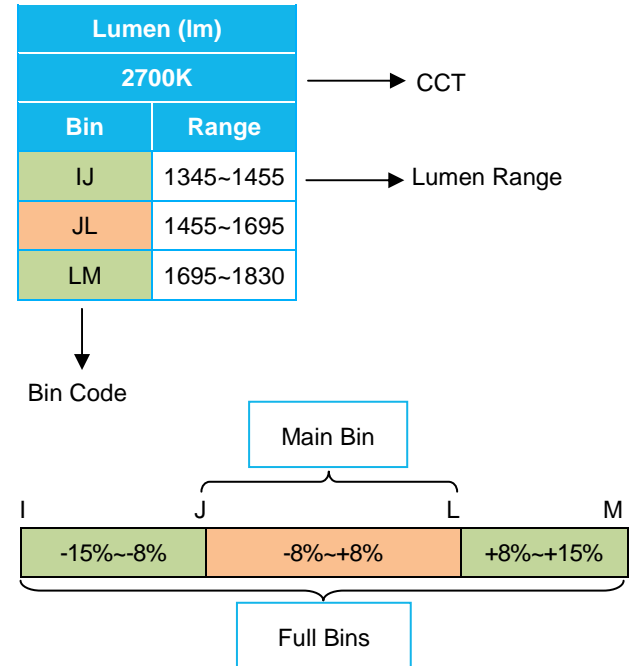

14 Series Lumen Bin

Lumen (lm)									
2700K		3000K		4000K		5000K		5700K	
Bin	Range	Bin	Range	Bin	Range	Bin	Range	Bin	Range
IJ	1345~1455	IJ	1345~1455	JK	1455~1570	JK	1455~1570	JK	1455~1570
JL	1455~1695	JL	1455~1695	KM	1570~1830	KM	1570~1830	KM	1570~1830
LM	1695~1830	LM	1695~1830	MN	1830~1975	MN	1830~1975	MN	1830~1975

18 Series Lumen Bin

Lumen (lm)									
2700K		3000K		4000K		5000K		5700K	
Bin	Range	Bin	Range	Bin	Range	Bin	Range	Bin	Range
LM	1695~1830	LM	1695~1830	MN	1830~1975	MN	1830~1975	MN	1830~1975
MO	1830~2130	MO	1830~2130	NP	1975~2300	NP	1975~2300	NP	1975~2300
OP	2130~2300	OP	2130~2300	PQ	2300~2485	PQ	2300~2485	PQ	2300~2485

LED HIGH POWER M03 Product Series

■ 22 Series Lumen Bin

Lumen (lm)									
2700K		3000K		4000K		5000K		5700K	
Bin	Range	Bin	Range	Bin	Range	Bin	Range	Bin	Range
NO	1975~2130	NO	1975~2130	OP	2130~2300	OP	2130~2300	OP	2130~2300
OQ	2130~2485	OQ	2130~2485	PR	2300~2680	PR	2300~2680	PR	2300~2680
QR	2485~2680	QR	2485~2680	RS	2680~2890	RS	2680~2890	RS	2680~2890

■ Forward Voltage Binning Parameter (25degC)

Parameter	Bin	Symbol	Min	Max	Unit	Condition
Forward Voltage	V1	V_F	33.6	42	V	I_F =Typical current

Note: Full Rank on Label

Example: V1/DF/D1

Forward Voltage Rank	Luminous Flux Rank	Color Rank
V1	DF	D1

LED HIGH POWER M03 Product Series

■ Example of LiteOn CoB MacAdam Ellipse Color Definition (Ex: 3000K)

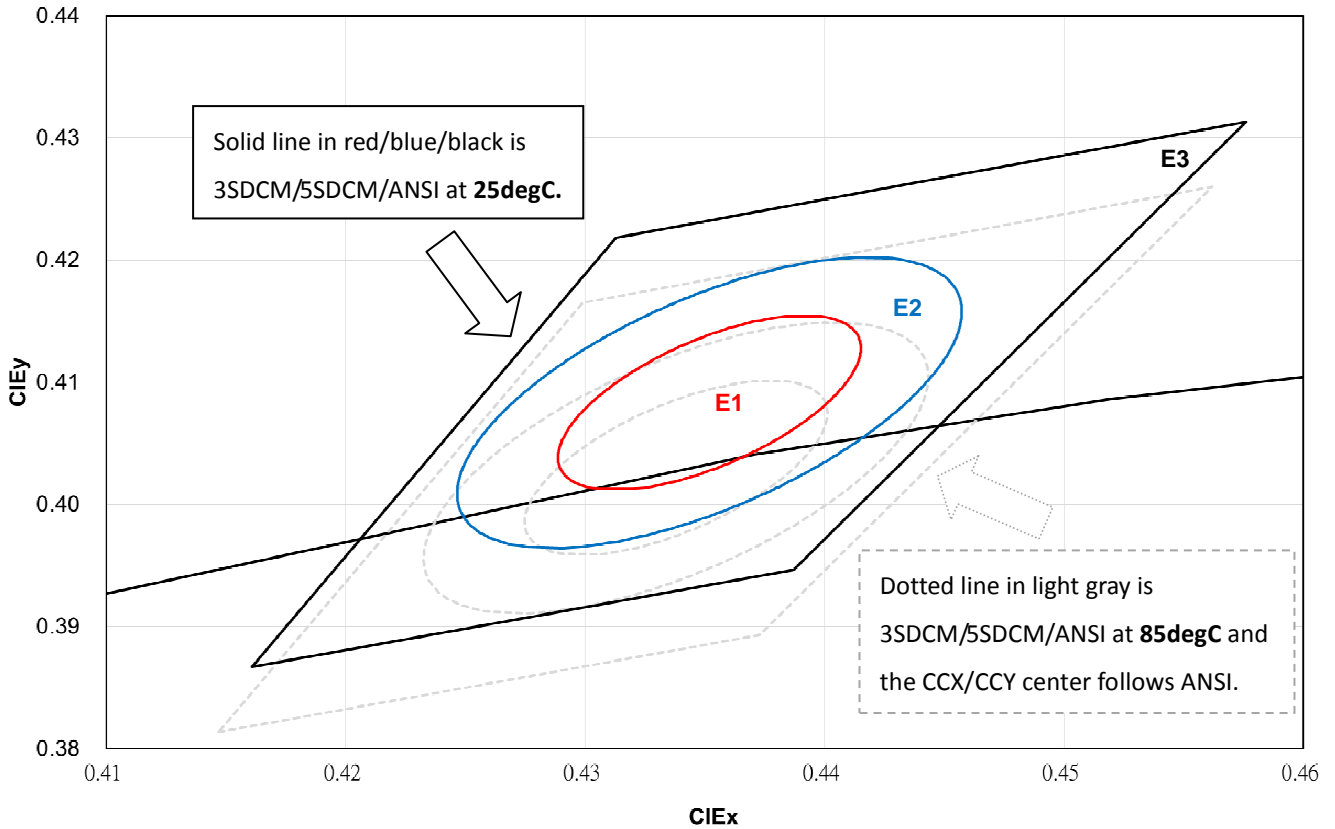

CIE Center Point						
CCT	25degC (LiteOn Spec.)		85degC (ANSI)		Hot/Cold Factor	
	CCX	CCY	CCX	CCY	CCX	CCY
2700	0.4582	0.4150	0.4578	0.4101	-0.0004	-0.0049
3000	0.4352	0.4083	0.4338	0.403	-0.0014	-0.0053
4000	0.3849	0.3856	0.3818	0.3797	-0.0031	-0.0059
5000	0.3486	0.3670	0.3447	0.3553	-0.0039	-0.0117
5700	0.3319	0.3513	0.3287	0.3417	-0.0032	-0.0096

Notes

1. LiteOn tester and shipping spec follow the color bin with 25degC CCX/CCY center.
2. The Hot/Cold factor means the CCX/CCY shift from 25degC to 85degC.
3. The Hot/Cold shift is measured by LiteOn CAS 140B instrument system.
4. The ellipse equation expression: $SDCM = (g11*(x-x_0)^2 + 2*g12*(x-x_0)*(y-y_0) + g22*(y-y_0)^2)^{0.5}$

LED HIGH POWER M03 Product Series

■ M03 CRI80 2700K

PN: LTPL-M036XXZS27-T0

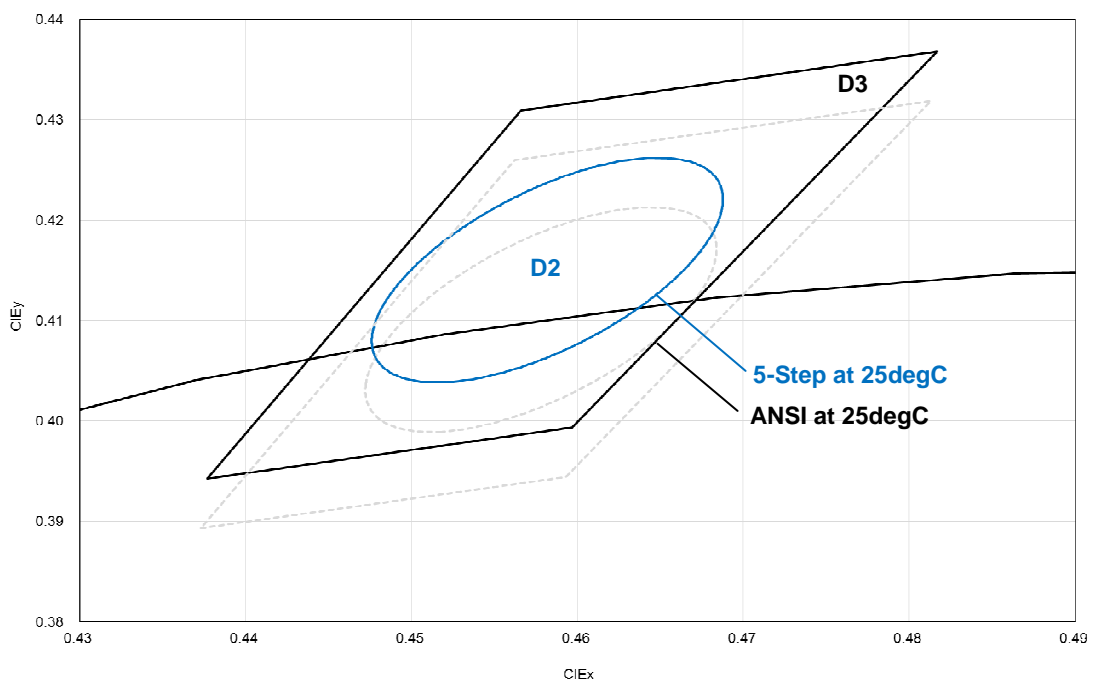
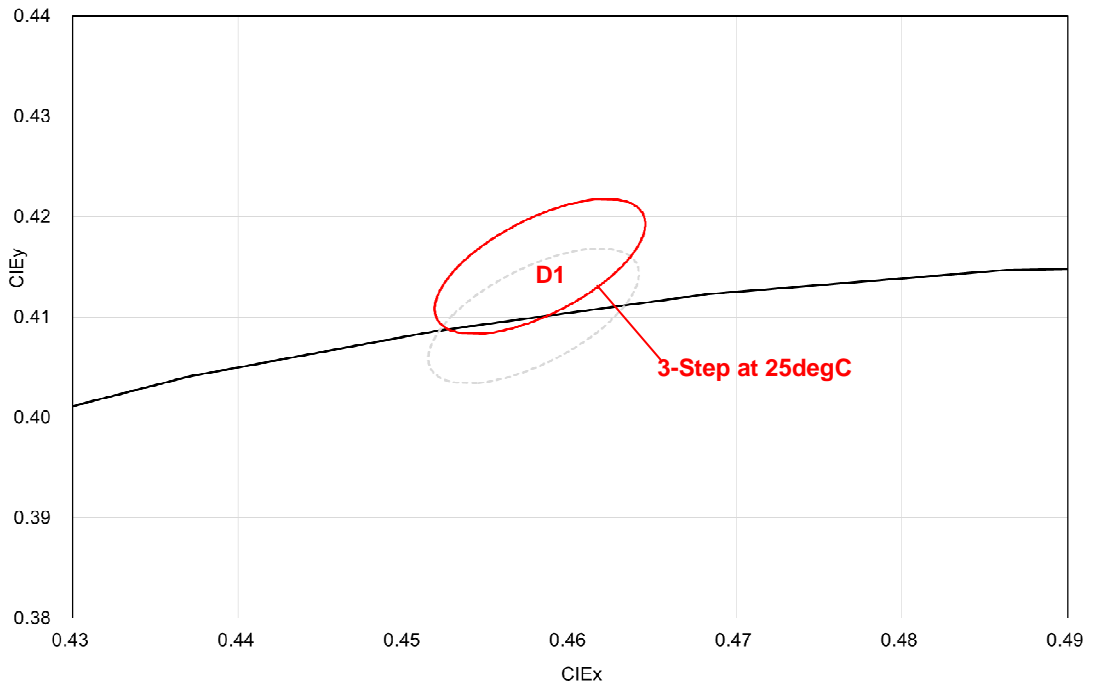

PN:LTPL-M036XXZS27-S1

**LED HIGH POWER
M03 Product Series**

■ M03 CRI80 3000K

PN: LTPL-M036XXZS30-T0

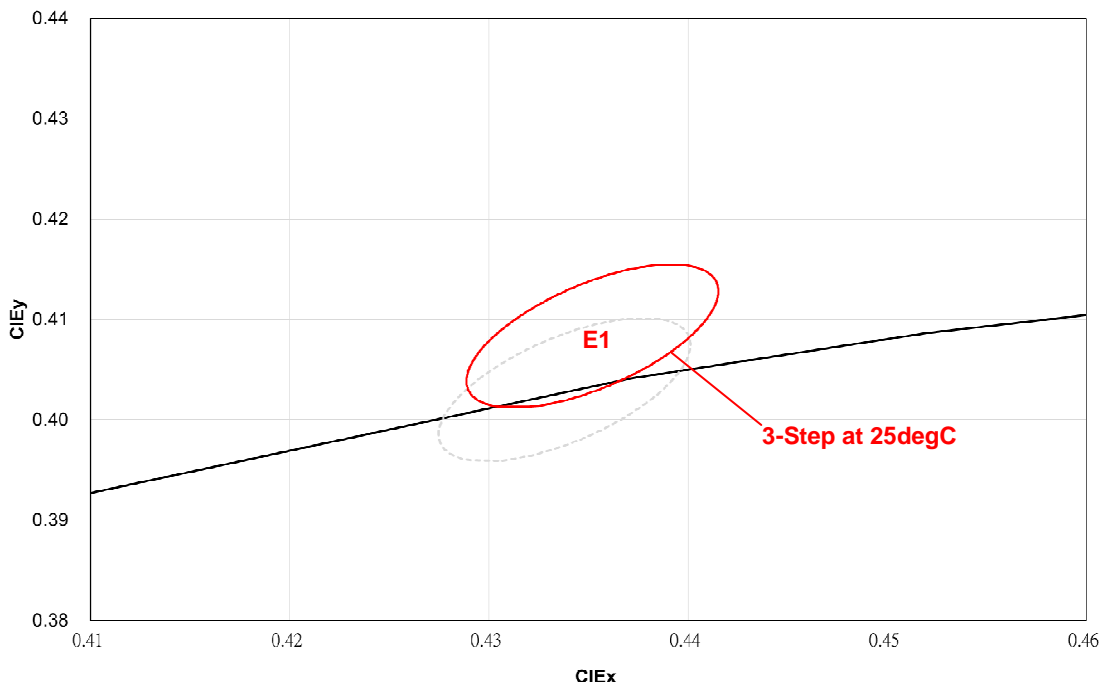

PN: LTPL-M036XXZS30-S1

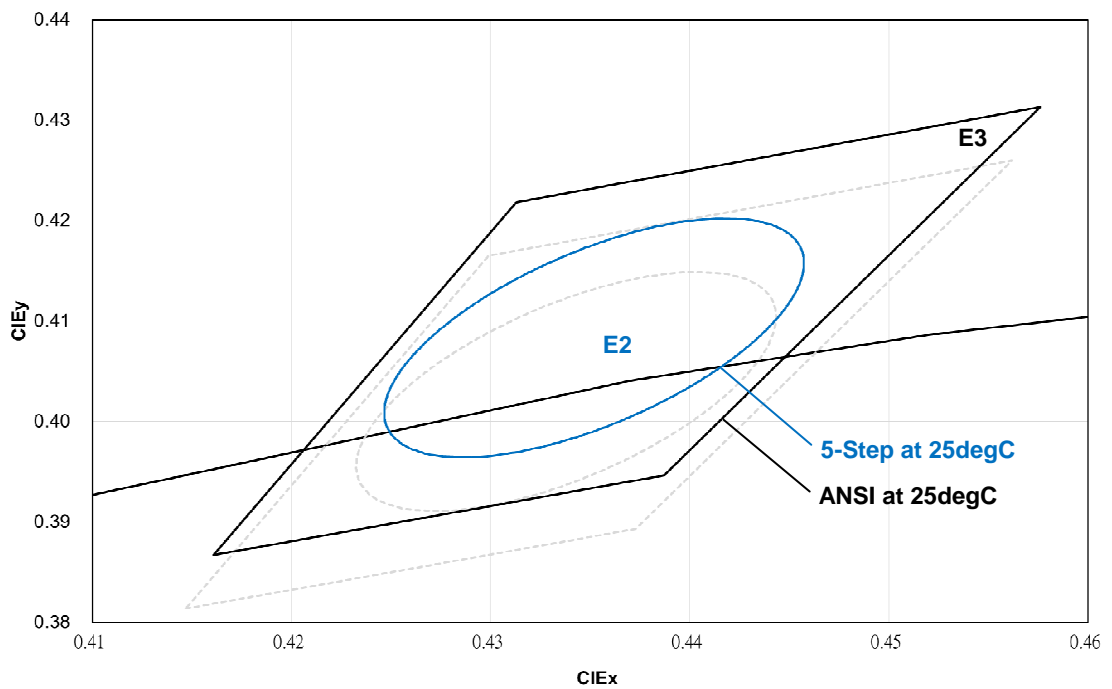

**LED HIGH POWER
M03 Product Series**

■ M03 CRI80 4000K

PN: LTPL-M036XXZS40-T0

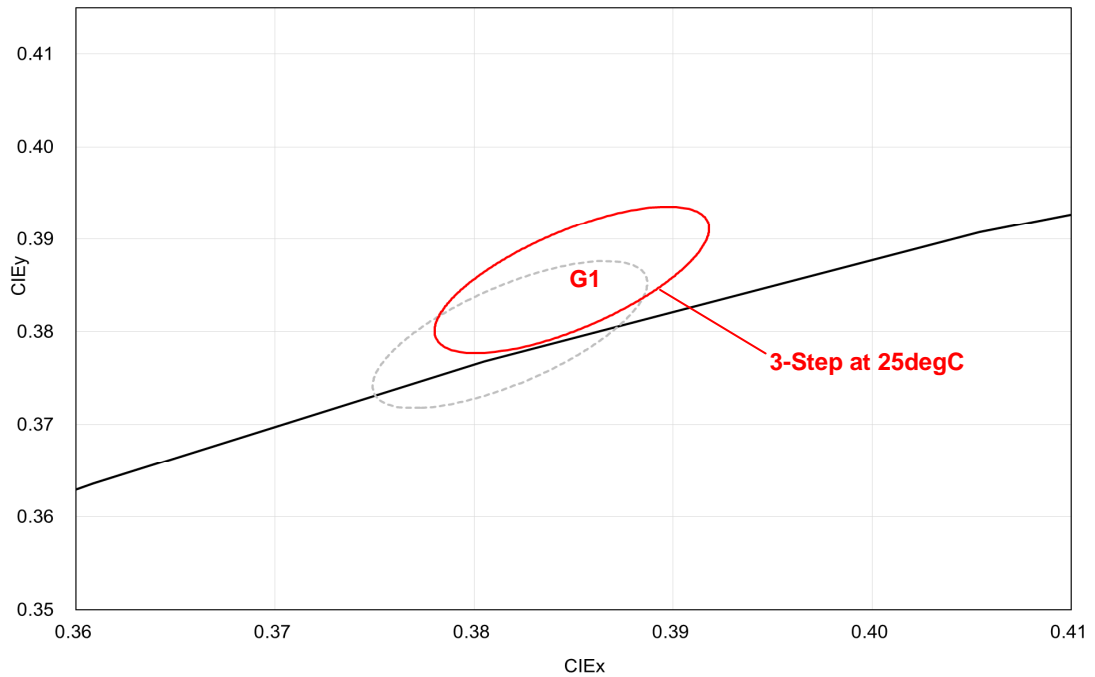

PN: LTPL-M036XXZS40-S1

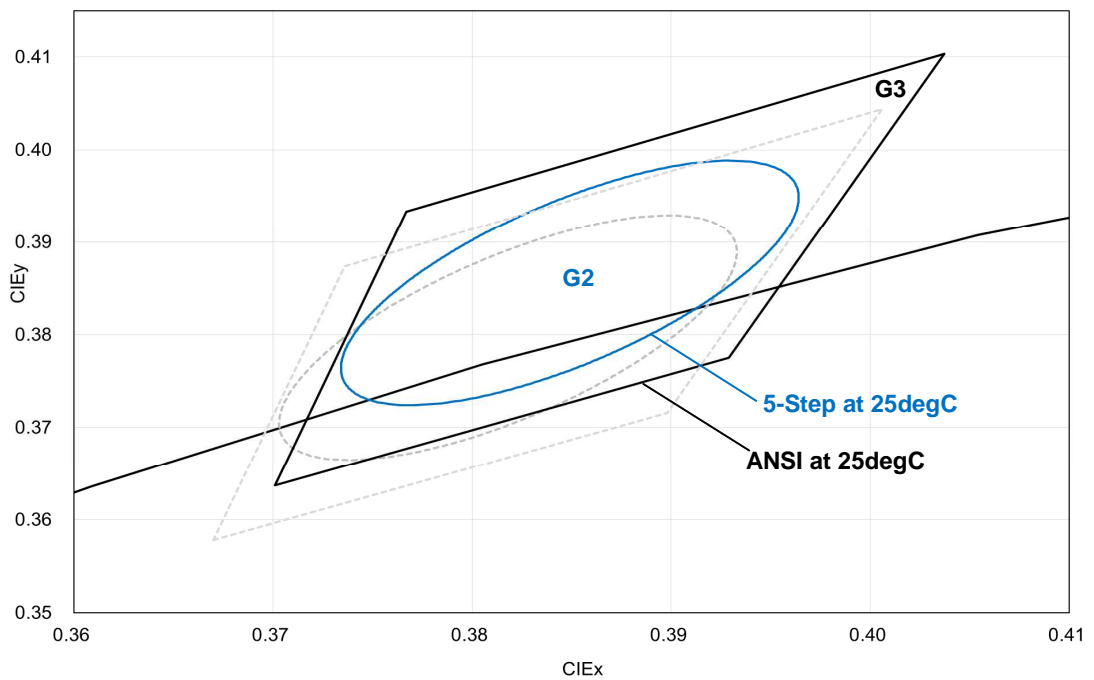

**LED HIGH POWER
M03 Product Series**

■ M03 CRI80 5000K

PN: LTPL-M036XXZS50-F1

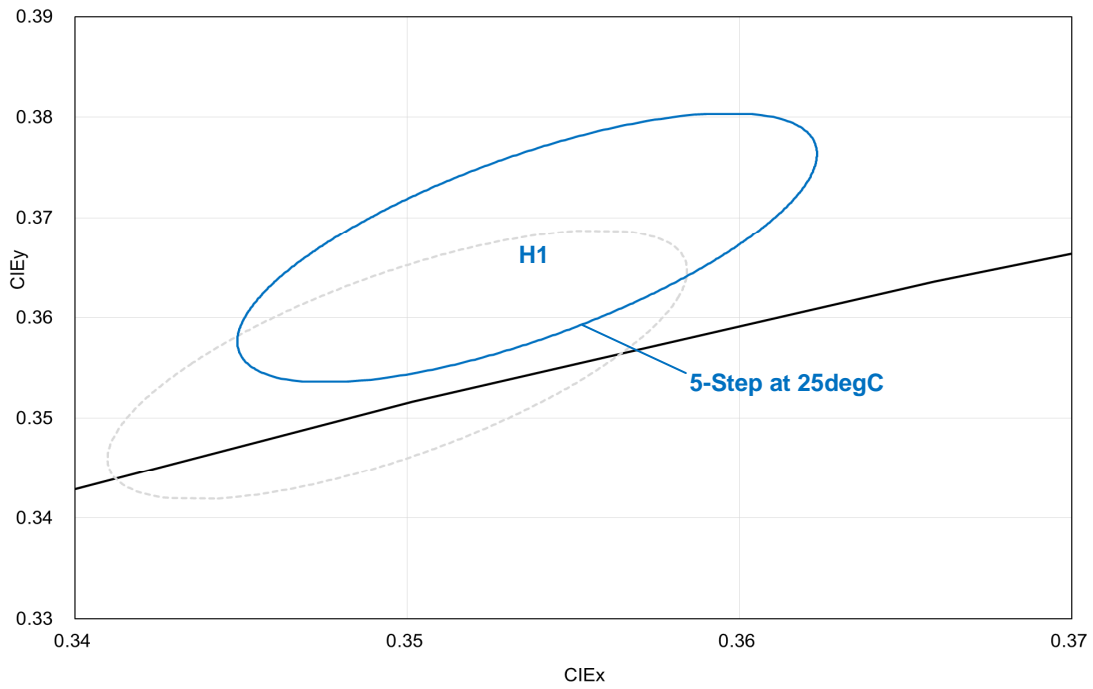

PN: LTPL-M036XXZS50-S1

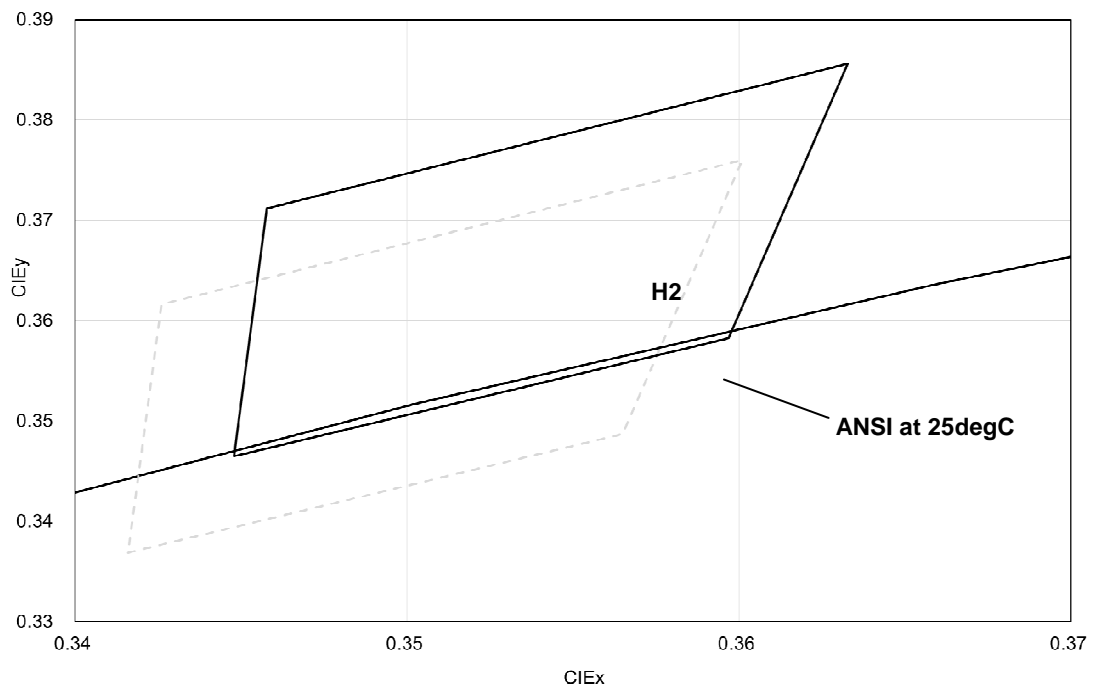

**LED HIGH POWER
M03 Product Series**

■ M03 CRI80 5700K

PN: LTPL-M036XXZS57-F1

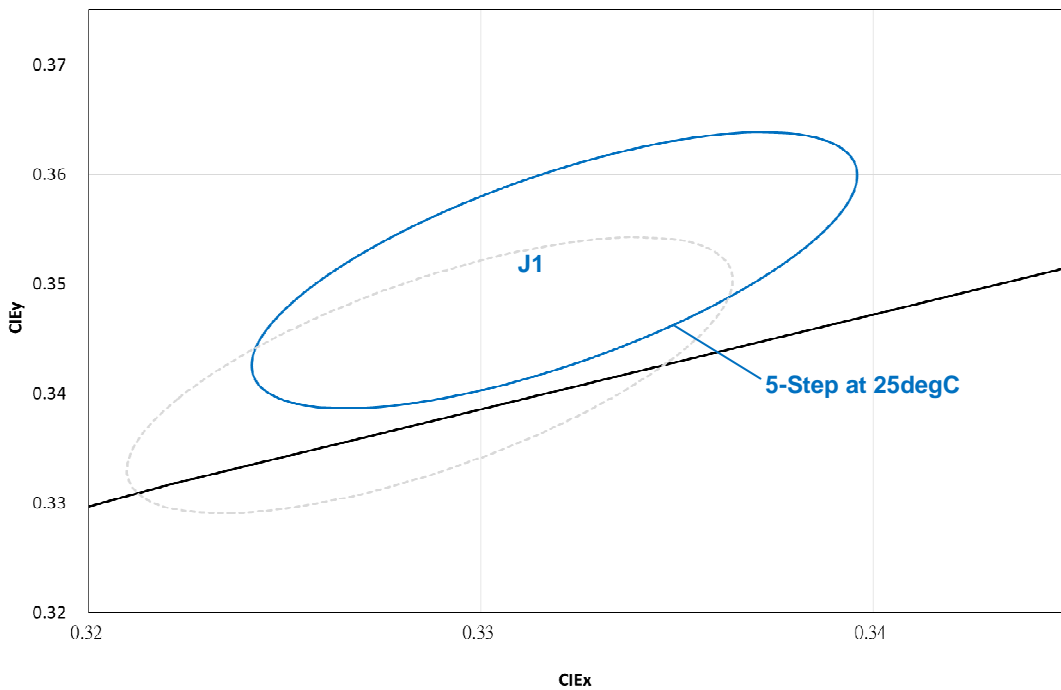

PN: LTPL-M036XXZS57-S1

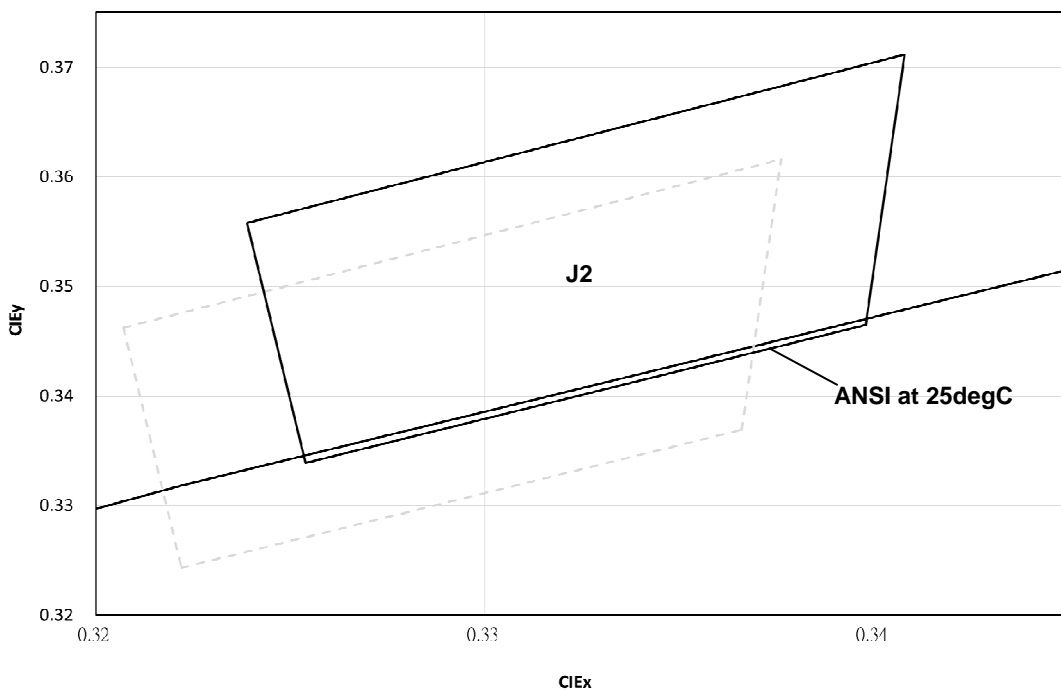

LED HIGH POWER M03 Product Series

6. Reliability Test Plan

No	Test item	Condition	Duration	Number of Failed	Result
1	High Temperature Operating Life	$T_c=85^{\circ}\text{C}$, I_F =Typical Current	1K hours	0/10	Pass
2	Wet High Temperature Operating Life	$60^{\circ}\text{C}/90\%\text{RH}$, I_F =Typical Current(DC) 30 mins ON/OFF	1K hours	0/10	Pass
3	Thermal Shock	-40°C to 125°C , 15minutes dwell, <10 seconds transfer, measurement in every 250 cycles	500 cycles	0/10	Pass
4	Fast Switch Cycling Test	40000cycles, 2 mins On/Off, Room temperature($25^{\circ}\text{C}\pm 5^{\circ}\text{C}$), measurement in every 5000 cycles	40K cycles	0/10	Pass
5	High Temperature Storage Life	$T_a=120^{\circ}\text{C}$	1K hours	0/10	Pass
6	Low Temperature Storage Life	$T_a=-55^{\circ}\text{C}$	1K hours	0/10	Pass
7	Mechanical Shock	1500G, 0.5ms pulse, 5 shocks each 6 axis	30 Times (5 shocks each 6 axis)	0/10	Pass
8	Variable Vibration Frequency	10-2000-10 Hz, log or linear sweep rate, 20G for approximately minute 1.5mm, each applied three times per axis over 6 hrs.	18 hrs (3 times per axis over 6 hrs)	0/10	Pass

■ Criteria for Judging the Damage

Item	Symbol	Test Condition	Criteria for Judgment	
			Min.	Max.
Forward Voltage	V_F	I_F =Typical Current		U.S.L. x 1.1
Luminous Flux	Lm	I_F =Typical Current	L.S.L. x 0.7	
CCX & CCY	X,Y	I_F =Typical Current		Shift<0.02

Notes

1. Operating life tests are mounted on thermal heat sink
2. Storage items are only component, not put on heat sink.

LED HIGH POWER M03 Product Series

7. Packing Specifications

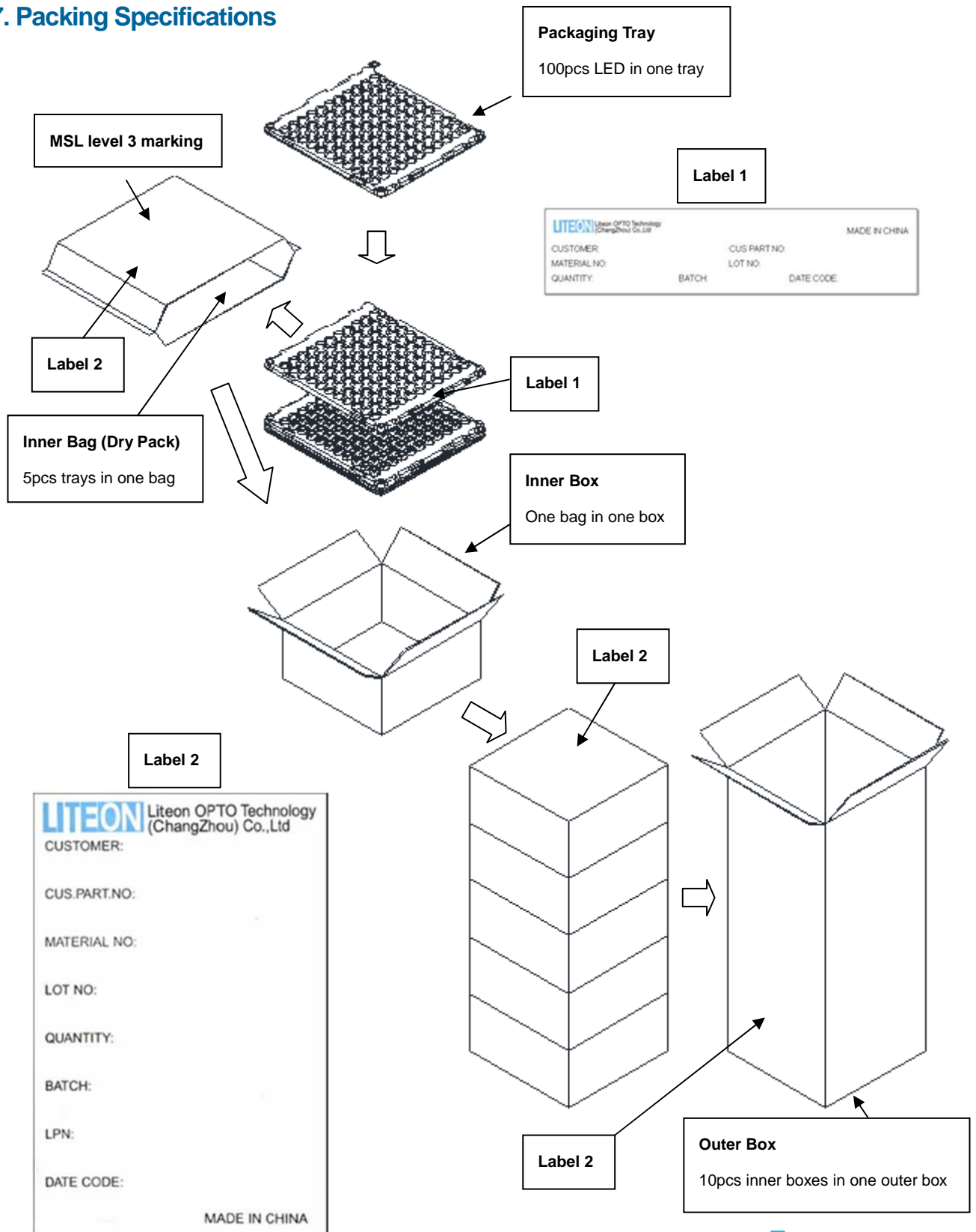

LED HIGH POWER M03 Product Series

8. Cautions

8.1 An LED is a current-operated device. In order to ensure intensity uniformity on multiple LEDs connected in parallel in an application, it is recommended that a current limiting resistor be incorporated in the drive circuit, in series with each LED as shown in circuit below.

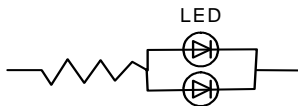

(A) Recommended circuit.

(B) The brightness of each LED might appear different due to the differences in the I-V characteristics of those LEDs.

8.2 Do not put any pressure on the light emitting surface either by finger or any hand tool and do not stack the COB products. Stress or pressure may cause damage to the wires of the LED array.

8.3 This product is not designed for the use under any of the following conditions, please confirm the performance and reliability are well enough if you use it under any of the following conditions

- Do not use sulfur-containing materials in commercial products including the materials such as seals and adhesives that may contain sulfur.
- Do not put this product in a place with a lot of moisture (over 85% relative humidity), dew condensation, briny air, and corrosive gas (Cl, H₂S, NH₃, SO₂, NO_x, etc.), exposure to a corrosive environment may affect silver plating.

ESD (Electrostatic Discharge)

Static Electricity or power surge will damage the LED. Suggestions to prevent ESD damage:

- Use of a conductive wrist band or anti-electrostatic glove when handling these LEDs.
- All devices, equipment, and machinery must be properly grounded.
- Work tables, storage racks, etc. should be properly grounded.
- Use ion blower to neutralize the static charge which might have built up on surface of the LED's plastic lens as a result of friction between LEDs during storage and handling.

ESD-damaged LEDs will exhibit abnormal characteristics such as high reverse leakage current, low forward voltage, or “no light up” at low currents.

To verify for ESD damage, check for “light up” and V_F of the suspect LEDs at low currents.

X-ON Electronics

Largest Supplier of Electrical and Electronic Components

Click to view similar products for [High Power LEDs - White category:](#)

Click to view products by [Lite-On manufacturer:](#)

Other Similar products are found below :

[G42180-08](#) [B42180-08](#) [STW8Q2PA-R5-HA](#) [SZ5-M1-W0-00-V3/W2-AA](#) [LTPL-P00DWS57](#) [LZP-D0WW00-0000](#) [CLM-9-30-90-36-AC32-F4-3](#) [SZ5-M1-WW-C8-V1/V3-FA](#) [BXRC-27E2000-D-73](#) [BXRC-27G2000-D-73](#) [BXRC-30E1000-D-73](#) [BXRC-30G2000-D-73](#) [BXRC-40E1000-D-73](#) [BXRE-30G2000-B-73](#) [BXRE-30G2000-C-73](#) [BXRE-50C2001-C-74](#) [CXM-22-27-80-54-AC30-F4-3](#) [XHP50B-00-0000-0D0UH245G](#) [XHP50B-00-0000-0D0UH240G](#) [XHP50B-00-0000-0D0UG227H](#) [XHP50B-00-0000-0D0HJ245G](#) [MP-5050-8100-27-80](#) [MP-5050-6100-65-80](#) [MP-5050-6100-50-80](#) [MP-5050-6100-40-80](#) [MP-5050-6100-30-80](#) [CXM-22-30-80-54-AC30-F4-3](#) [LTW-2835SZK57](#) [BXEM-50C0000-0-000](#) [WW-WNA30TS-U1\(M1\)](#) [KW CSLPM2.CC-8L8M-4L8N](#) [KW CSLPM2.CC-8L8M-4O9Q](#) [KW DPLS32.SB-6H6J-E5P7-EG-Z264](#) [L1V1-507003V500000](#) [CXM-22-35-80-36-AC10-F3-3](#) [KW3 CGLNM1.TG-Z6QF6-EBVFFCBB46-DFGA](#) [JB5630AWT-H-H65EA0000-NZ000001](#) [XHP50B-00-0000-0D0UG430H](#) [CXM-22-35-90-54-AC40-F5-3](#) [CXM-22-35-80-54-AC40-F5-3](#) [OSM51206E1N-0.8T](#) [OSW43020C1C](#) [MP161611032290](#) [MP-1616-2103-50-90](#) [KW CULPM1.TG-Z6RF7-ebvFfcbB46-65G5](#) [KW DMLS33.SG-Z6M7-EBVFFCBB46-8E8G-700-S](#) [XPGDWT-B1-0000-00EEA](#) [XHP70B-00-0000-0D0BP450E](#) [KW DMLN33.SG-7J7K-EBVFFCBB46-8E8G-200-S](#) [ASMT-MW05-NMNS1](#)