



# LED Middle POWER

## 2835 Product Data Sheet

### SZKXX Series

Create Date : 07 / 22 / 2014

Revision: 5.0, 9 / 26 / 2014

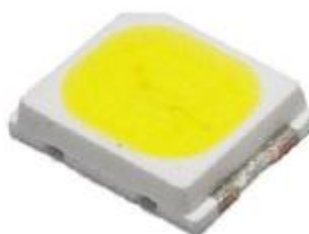

## Light LED LTW-2835SZKXX Series

### 1. Description

The LiteON 2835 Product series is a wide beam angle standard-dimension package, combining the lifetime and reliability advantages of Light Emitting Diodes with the brightness of conventional lighting. It gives you total design freedom and unmatched brightness, creating a new opportunities for solid state lighting to displace conventional lighting technologies.

#### 1.1 Features

- Package in 8mm tape on 7" diameter reels.
- Compatible with automatic placement equipment.
- Compatible with infrared and vapor phase reflow solder process.
- EIA STD package.
- I.C. compatible.
- Meet green product and Pb-free(According to RoHS)

#### 1.2 Available Part Numbers

CCT	Part No.
2700K	LTW-2835SZK27
3000K	LTW-2835SZK30
3500K	LTW-2835SZK35
4000K	LTW-2835SZK40
5000K	LTW-2835SZK50
5700K	LTW-2835SZK57
6500K	LTW-2835SZK65

# Light LED LTW-2835SZKXX Series

## 2. Outline Dimensions

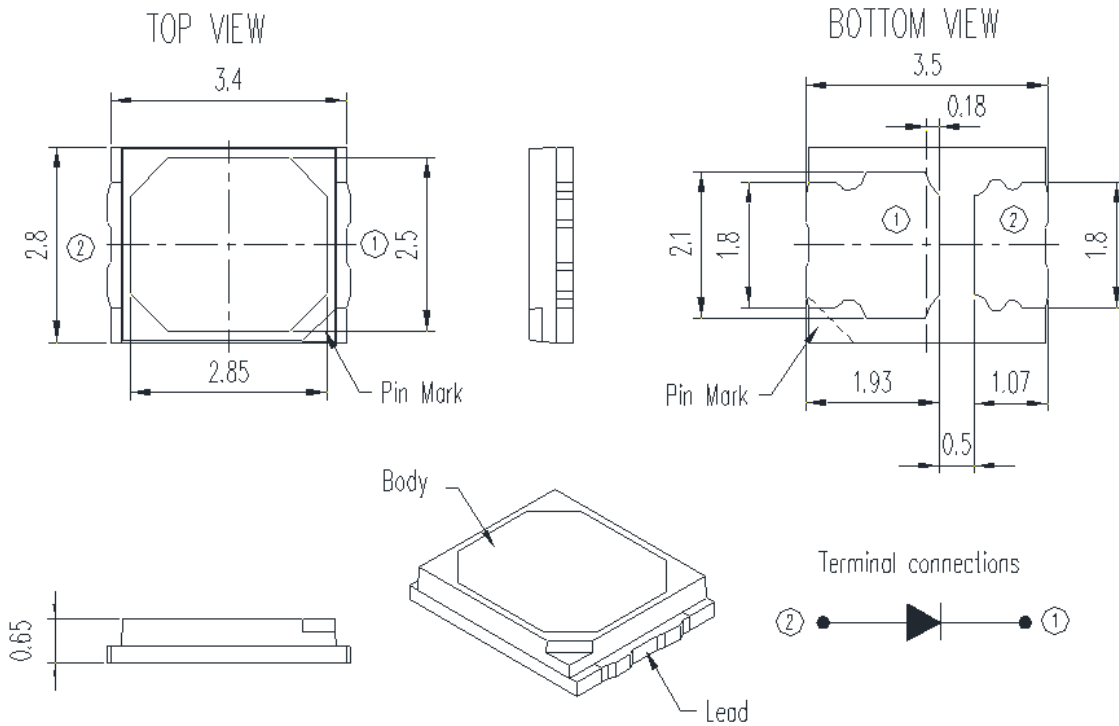

Part No.	Lens Color	Source Color
LTW-2835SZK27	Orange	InGaN Blue
LTW-2835SZK30		
LTW-2835SZK35		
LTW-2835SZK40		
LTW-2835SZK50		
LTW-2835SZK57		
LTW-2835SZK65		

### Notes:

1. All dimensions are in millimeters.
2. Thickness tolerance of copper plate is  $\pm 0.02$  mm.
3. Thickness tolerance of product is  $\pm 0.05$  mm.
4. Tolerance is  $\pm 0.1$  mm unless otherwise noted.

**Light LED  
LTW-2835SZKXX Series**

**3. Absolute Maximum Ratings at Ta=25°C**

Parameter	Symbol	Rating	Unit
Power Dissipation	P <sub>o</sub>	256	mW
Continuous Forward Current	I <sub>F</sub>	80	mA
Pulse Forward Current	I <sub>PF</sub>	150	mA
Reverse Current @ -5V	I <sub>R</sub>	10	μA
Operating Temperature Range	T <sub>opr</sub>	-40 ~ +85	°C
Storage Temperature Range	T <sub>stg</sub>	-40 ~ +100	°C
Junction Temperature	T <sub>j</sub>	115	°C

**Note:**

1. Pulsed Duty  $\leq 1/10$ , Pulse width  $\leq 100\mu s$ .
2. Forbid to operating at reverse voltage condition for long
3. It is recommended to follow de-rating curve to use maximum rating to ensure LED can operated normally.

**Light LED  
LTW-2835SZKXX Series**

**4. Electro-Optical Characteristics at Ta=25°C**

4.1 Typical Performance

Parameter	Symbol	Values								Unit	Test Condition
		Typ.	2700	3000	3500	4000	5000	5700	6500		
Correlated Color Temp.	CCT	Typ.	2700	3000	3500	4000	5000	5700	6500	'K	
Chromaticity	x	Typ.	0.458	0.434	0.408	0.382	0.345	0.329	0.312	-	If = 60mA
Coordinates	y	Typ.	0.410	0.403	0.392	0.380	0.355	0.342	0.328		
Luminous Flux <sup>1</sup>	Φ <sub>v</sub>	Min	21	22	23	24	24	24	24	lm	
		Typ.	22.5	24	24.5	25.5	26	26	25.5		
		Max.	27	28	29	30	30	30	30		
Optical Efficacy	η <sub>opt</sub>	Typ.	123	131	134	139	142	142	139	lm/W	
Color Rendering Index	CRI	Min.	80							-	
Viewing Angle	2θ <sub>1/2</sub>	Typ.	120							deg	
Forward Voltage	V <sub>F</sub>	Min	2.90							V	
		Typ.	3.05								
		Max.	3.20								
Thermal Resistance	R <sub>jt</sub>	Typ.	35							°C/W	
ESD-Withstand Voltage	ESD	Min	2K							HBM	V

Notes

- Luminous flux is the total luminous flux output as measured with an integrating sphere.
- Iv classification code is marked on each packing bag.
- The chromaticity coordinates (x, y) is derived from the 1931 CIE chromaticity diagram.
- Caution in ESD:  
Static Electricity and surge damages the LED. It is recommended using a wrist band or anti-electrostatic glove when handling the LED. All devices, equipment and machinery must be properly grounded.
- CAS140B is the test standard for the chromaticity coordinates (x, y) & Iv
- The chromaticity coordinates (x, y) guarantee should be added ± 0.007 tolerance
- Ra measurement allowance is ±3
- Luminous flux measurement tolerance is ±10%
- Forward Voltage measurement tolerance is ±0.1V
- Rth<sub>j,s</sub> is the thermal resistance from junction to solder point on MCPCB with electrical power.

# Light LED LTW-2835SZKXX Series

## 4.2 Forward Current vs. Lumen

Current (mA)	V <sub>F</sub> (V)	Lumen (lm)						
		2700K	3000K	3500K	4000K	5000K	5700K	6500K
10	2.71	4.4	4.7	4.7	4.9	4.9	4.9	4.9
20	2.80	8.5	9.1	9.2	9.6	9.7	9.7	9.5
30	2.87	12.3	13.1	13.3	13.9	14.0	14.1	13.8
40	2.94	15.9	16.9	17.2	18.0	18.2	18.3	17.9
50	3.00	19.2	20.5	20.9	21.8	22.2	22.2	21.8
60	3.05	22.5	24.0	24.5	25.5	26.0	26.0	25.5
65	3.08	23.9	25.5	26.1	27.1	27.7	27.7	27.2
70	3.11	25.4	27.1	27.7	28.8	29.3	29.4	28.9
80	3.16	28.3	30.1	30.8	31.9	32.7	32.9	32.3

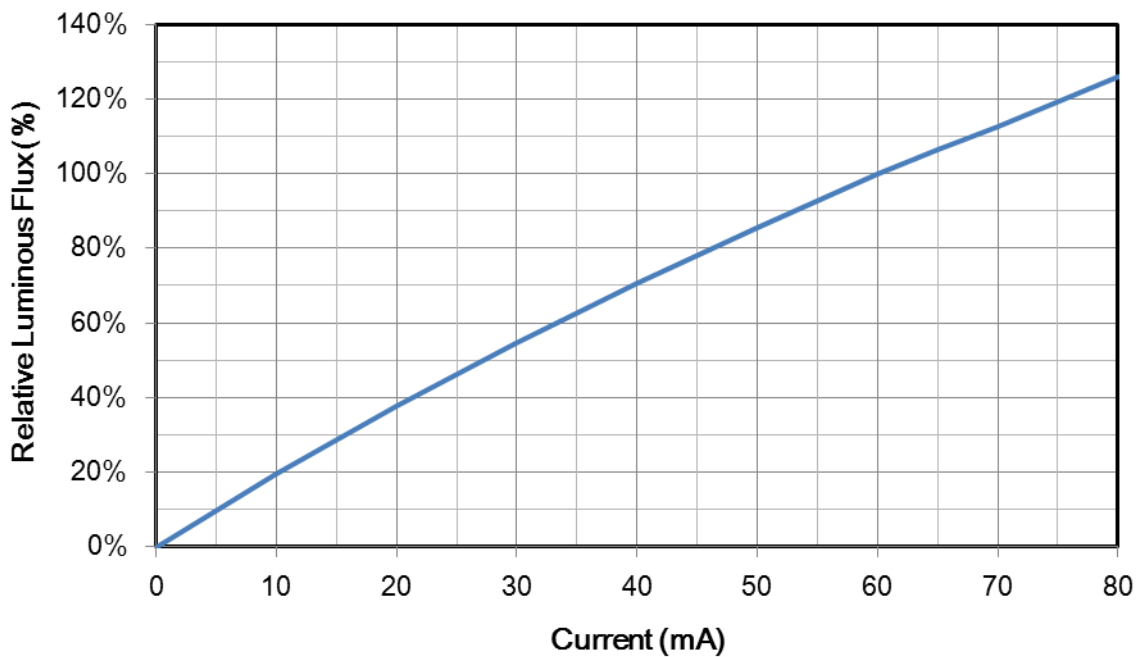

**Light LED  
LTW-2835SZKXX Series**

4.3 Relative Spectral Power Distribution at Typical Current

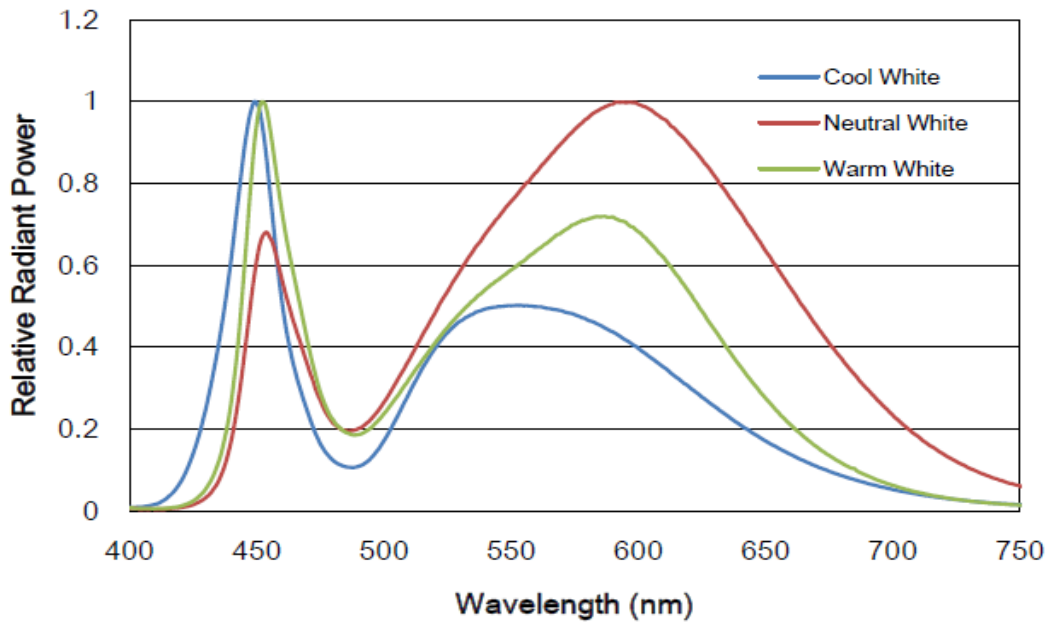

4.4 Radiation Characteristics

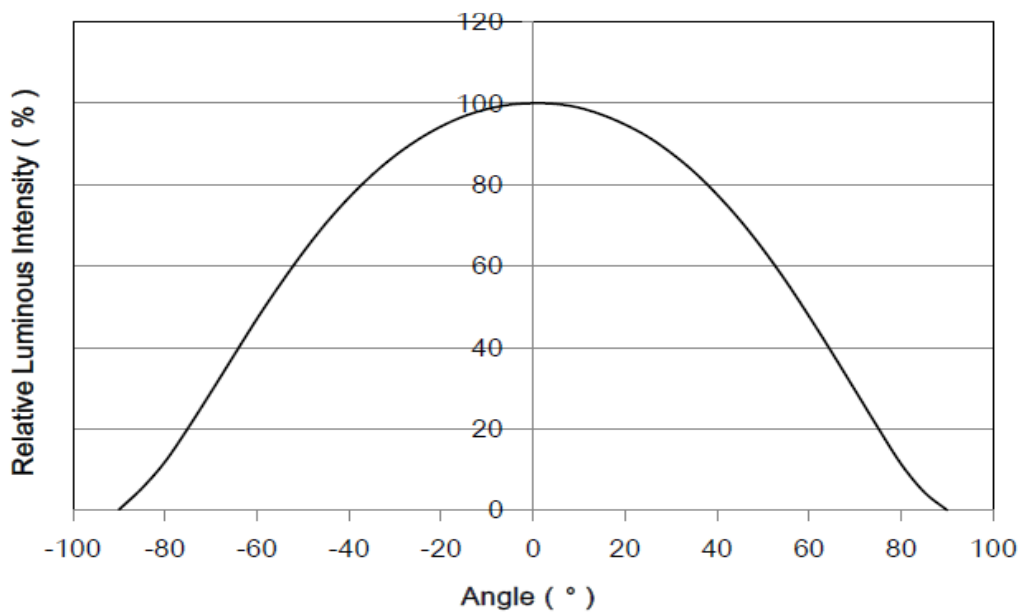

**Light LED  
LTW-2835SZKXX Series**

4.5 Forward Current vs. Forward Voltage

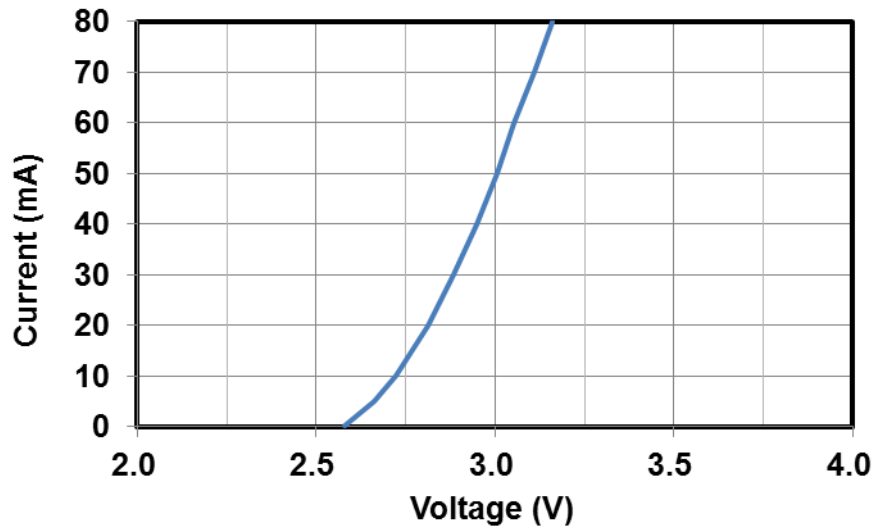

4.6 Forward Current Derating Curve

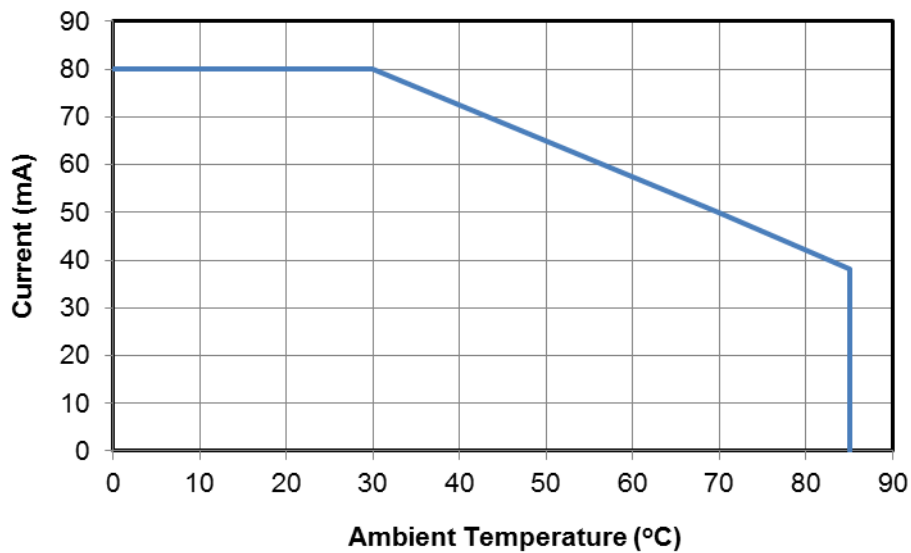



Light LED  
LTW-2835SZKXX Series

4.7 Relative Intensity vs. Junction Temperature

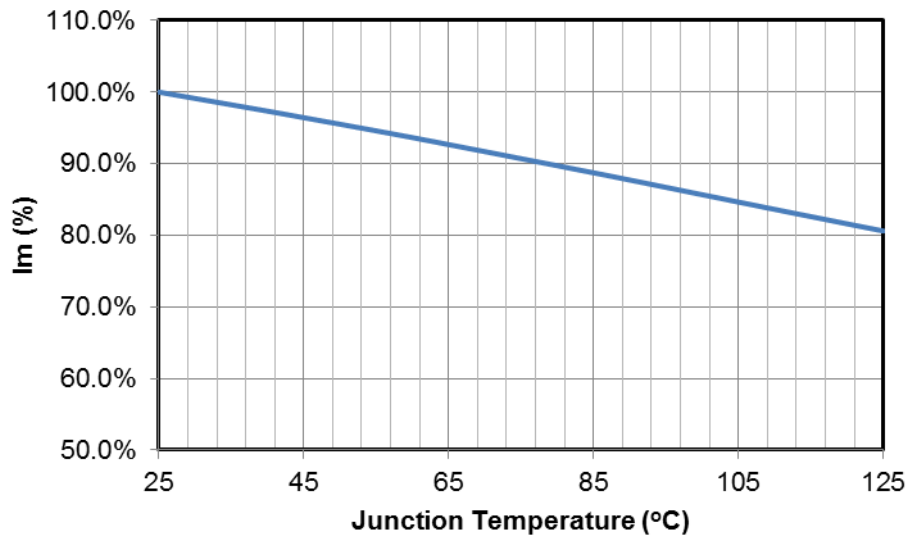

**Light LED  
LTW-2835SZKXX Series**

**5. Binning Definition**

**5.1 Color Bin**

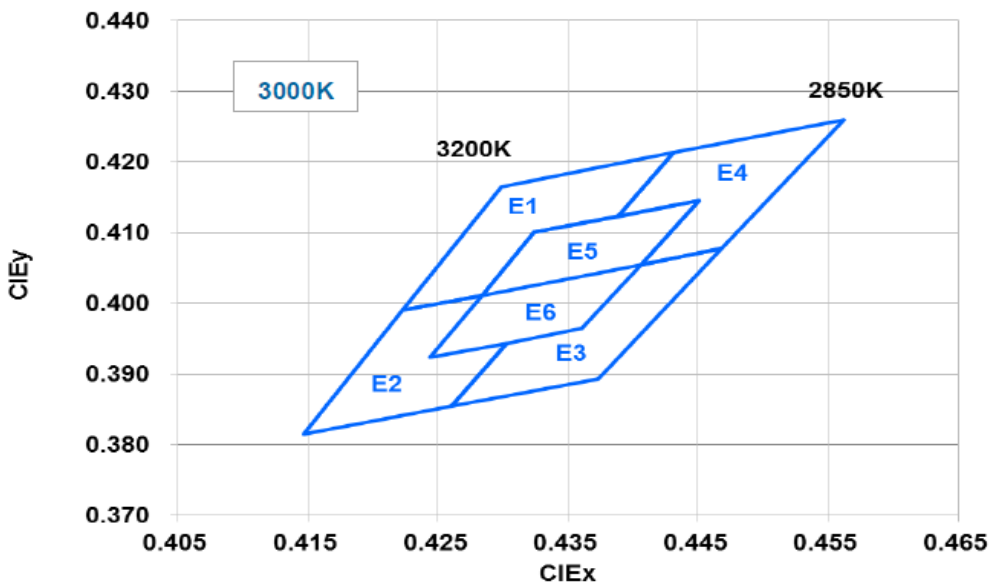
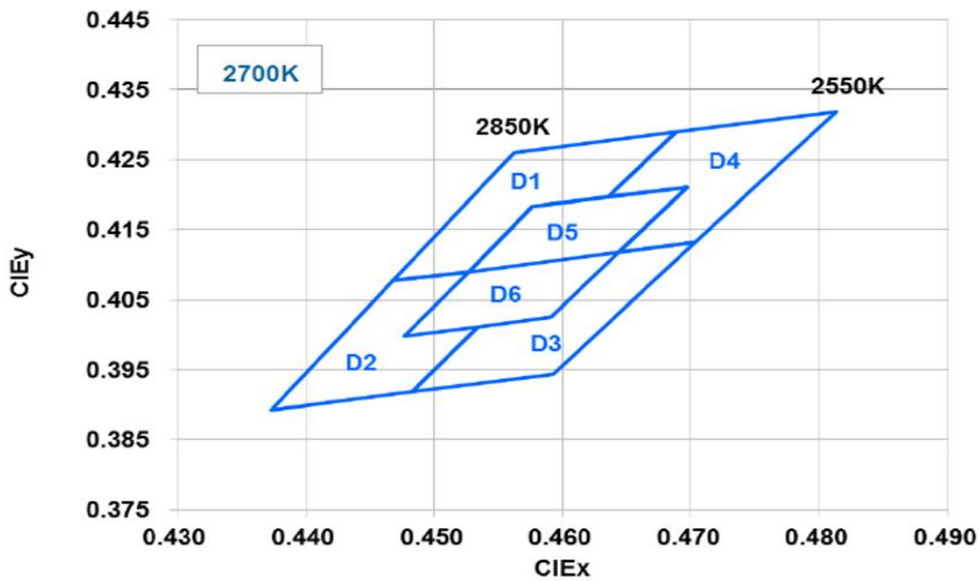

**Light LED  
LTW-2835SZKXX Series**

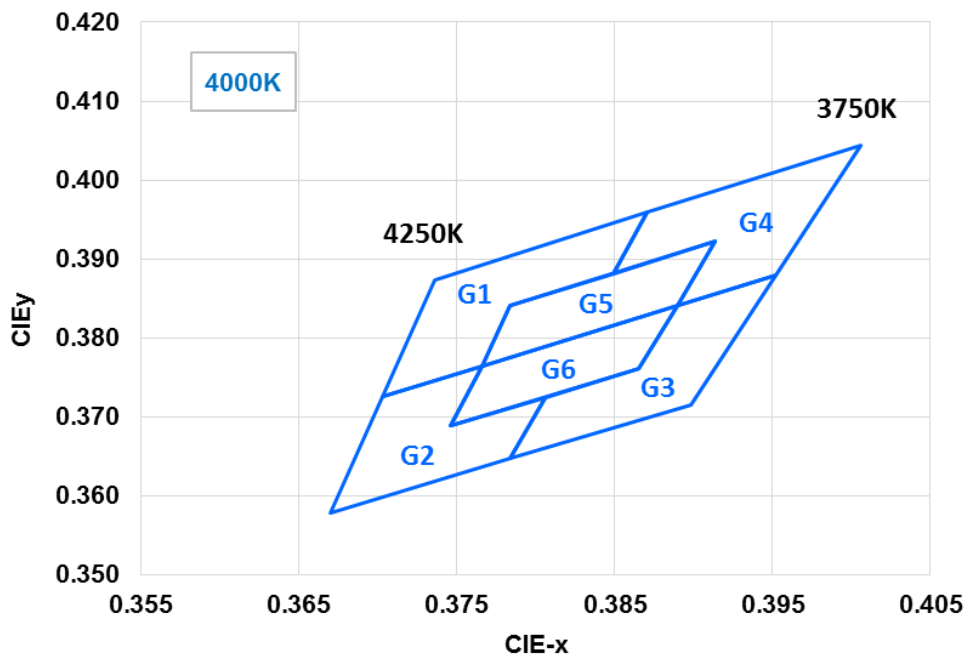
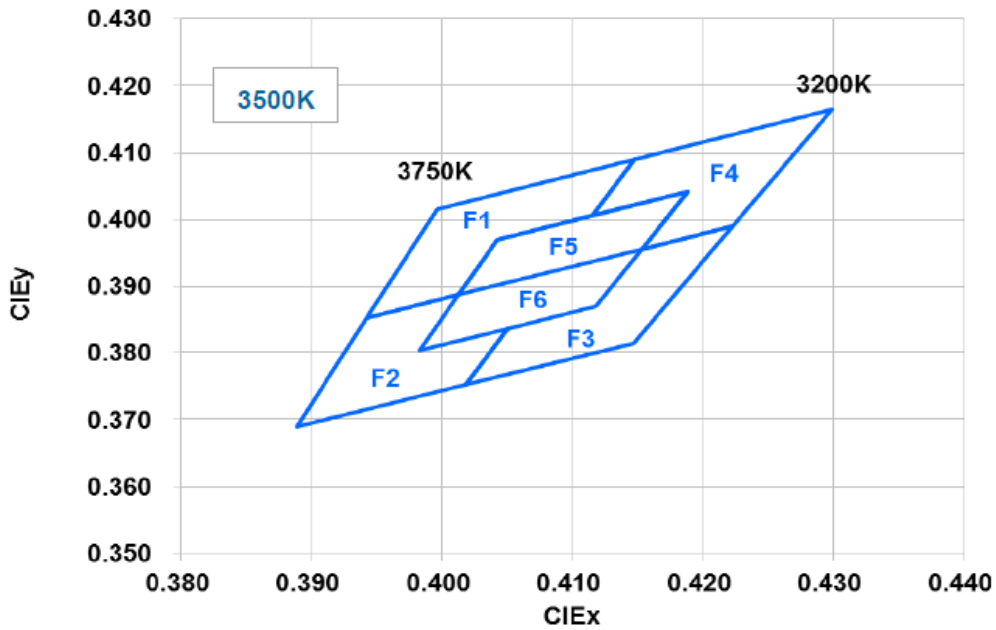



# Light LED LTW-2835SZKXX Series

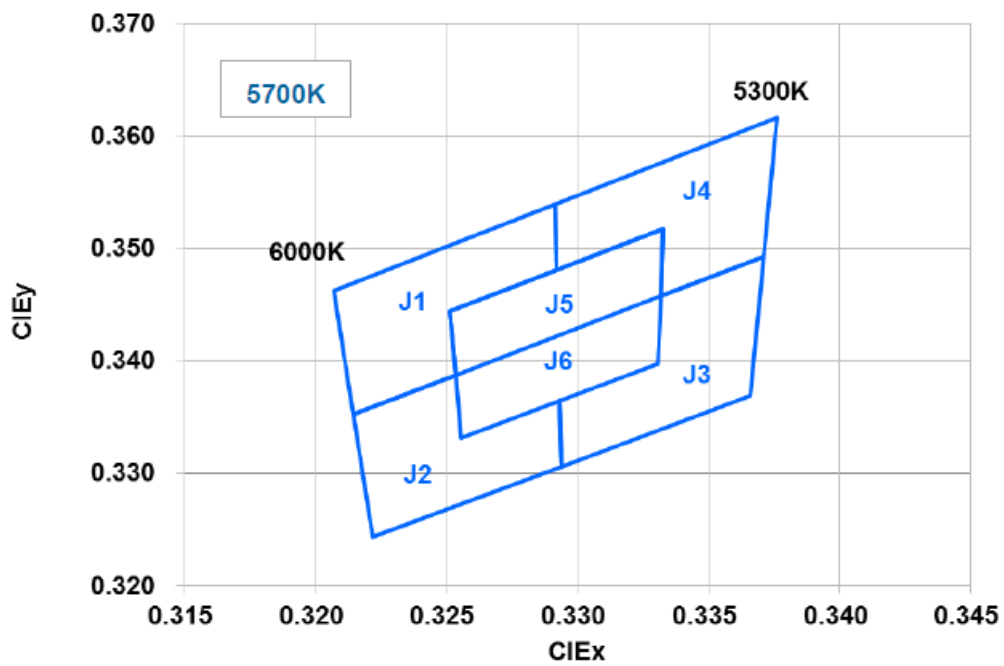
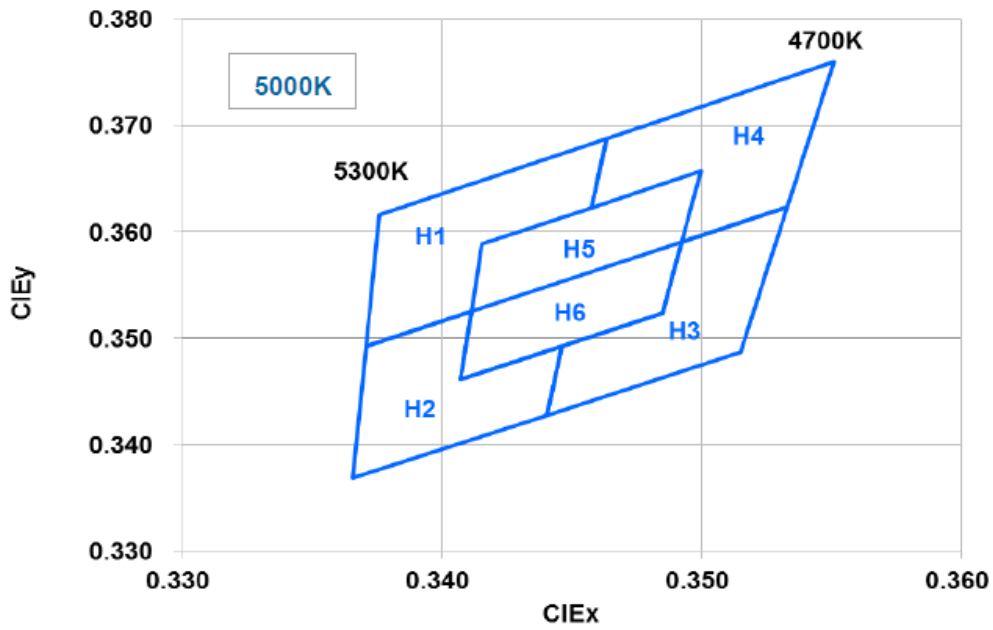



**Light LED  
LTW-2835SZKXX Series**

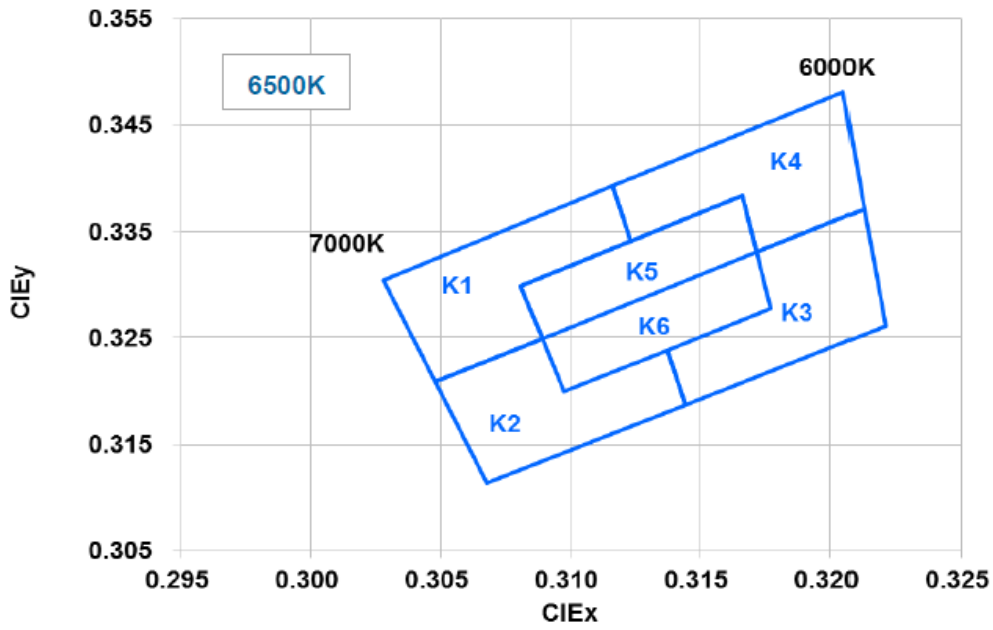

# Light LED LTW-2835SZKXX Series

## 5.2 Color Rank

2700K (I <sub>f</sub> = 60 mA)											
Rank	-	x	y	Rank	-	x	y	Rank	-	x	y
<b>D1</b>	1	0.4468	0.4077	<b>D3</b>	1	0.4483	0.3919	<b>D5</b>	1	0.4576	0.4183
	2	0.4562	0.4260		2	0.4534	0.4011		2	0.4697	0.4211
	3	0.4688	0.4290		3	0.4591	0.4025		3	0.4644	0.4118
	4	0.4636	0.4197		4	0.4644	0.4118		4	0.4527	0.4090
	5	0.4576	0.4183		5	0.4703	0.4132				
	6	0.4527	0.4090		6	0.4593	0.3944				
<b>D2</b>	1	0.4373	0.3893	<b>D4</b>	1	0.4688	0.4290	<b>D6</b>	1	0.4527	0.4090
	2	0.4468	0.4077		2	0.4813	0.4319		2	0.4644	0.4118
	3	0.4527	0.4090		3	0.4703	0.4132		3	0.4591	0.4025
	4	0.4477	0.3998		4	0.4644	0.4118		4	0.4477	0.3998
	5	0.4534	0.4011		5	0.4697	0.4211				
	6	0.4483	0.3919		6	0.4636	0.4197				

Tolerance on each Hue bin (x,y) is +/- 0.007

3000K (I <sub>f</sub> = 60 mA)											
Rank	-	x	y	Rank	-	x	y	Rank	-	x	y
<b>E1</b>	1	0.4223	0.3990	<b>E3</b>	1	0.4260	0.3854	<b>E5</b>	1	0.4324	0.4100
	2	0.4299	0.4165		2	0.4303	0.3943		2	0.4451	0.4146
	3	0.4431	0.4213		3	0.4361	0.3964		3	0.4406	0.4055
	4	0.4388	0.4123		4	0.4406	0.4055		4	0.4284	0.4011
	5	0.4324	0.4100		5	0.4468	0.4077				
	6	0.4284	0.4011		6	0.4373	0.3893				
<b>E2</b>	1	0.4147	0.3814	<b>E4</b>	1	0.4431	0.4213	<b>E6</b>	1	0.4284	0.4011
	2	0.4223	0.3990		2	0.4562	0.4260		2	0.4406	0.4055
	3	0.4284	0.4011		3	0.4468	0.4077		3	0.4361	0.3964
	4	0.4244	0.3923		4	0.4406	0.4055		4	0.4244	0.3923
	5	0.4303	0.3943		5	0.4451	0.4146				
	6	0.4260	0.3854		6	0.4388	0.4123				

Tolerance on each Hue bin (x,y) is +/- 0.007

Light LED  
LTW-2835SZKXX Series

3500K ( $I_f = 60$ mA)											
Rank	-	x	y	Rank	-	x	y	Rank	-	x	y
F1	1	0.3943	0.3853	F3	1	0.4018	0.3752	F5	1	0.4042	0.3970
	2	0.3996	0.4015		2	0.4050	0.3837		2	0.4188	0.4041
	3	0.4148	0.4090		3	0.4118	0.3869		3	0.4153	0.3955
	4	0.4115	0.4006		4	0.4153	0.3955		4	0.4013	0.3887
	5	0.4042	0.3970		5	0.4223	0.3990				
	6	0.4013	0.3887		6	0.4147	0.3814				
F2	1	0.3889	0.3690	F4	1	0.4148	0.4090	F6	1	0.4013	0.3887
	2	0.3943	0.3853		2	0.4299	0.4165		2	0.4153	0.3955
	3	0.4013	0.3887		3	0.4223	0.3990		3	0.4118	0.3869
	4	0.3983	0.3804		4	0.4153	0.3955		4	0.3983	0.3804
	5	0.4050	0.3837		5	0.4188	0.4041				
	6	0.4018	0.3752		6	0.4115	0.4006				

Tolerance on each Hue bin (x,y) is +/- 0.007

4000K ( $I_f = 60$ mA)											
Rank	-	x	y	Rank	-	x	y	Rank	-	x	y
G1	1	0.3703	0.3726	G3	1	0.3784	0.3647	G5	1	0.3784	0.3841
	2	0.3736	0.3874		2	0.3806	0.3725		2	0.3914	0.3922
	3	0.3871	0.3959		3	0.3865	0.3762		3	0.3890	0.3842
	4	0.3849	0.3881		4	0.3890	0.3842		4	0.3766	0.3765
	5	0.3784	0.3841		5	0.3952	0.3880				
	6	0.3766	0.3765		6	0.3898	0.3716				
G2	1	0.3670	0.3578	G4	1	0.3871	0.3959	G6	1	0.3766	0.3765
	2	0.3703	0.3726		2	0.4006	0.4044		2	0.3890	0.3842
	3	0.3766	0.3765		3	0.3952	0.3880		3	0.3865	0.3762
	4	0.3746	0.3689		4	0.3890	0.3842		4	0.3746	0.3689
	5	0.3806	0.3725		5	0.3914	0.3922				
	6	0.3784	0.3647		6	0.3849	0.3881				

Tolerance on each Hue bin (x,y) is +/- 0.007

# Light LED LTW-2835SZKXX Series

5000K ( $I_f = 60$ mA)											
Rank	-	x	y	Rank	-	x	y	Rank	-	x	y
H1	1	0.3371	0.3493	H3	1	0.3441	0.3428	H5	1	0.3416	0.3589
	2	0.3376	0.3616		2	0.3446	0.3493		2	0.3500	0.3657
	3	0.3464	0.3688		3	0.3485	0.3524		3	0.3493	0.3591
	4	0.3458	0.3623		4	0.3493	0.3591		4	0.3412	0.3525
	5	0.3416	0.3589		5	0.3533	0.3624				
	6	0.3412	0.3525		6	0.3515	0.3487				
H2	1	0.3366	0.3369	H4	1	0.3464	0.3688	H6	1	0.3412	0.3525
	2	0.3371	0.3493		2	0.3551	0.3760		2	0.3493	0.3591
	3	0.3412	0.3525		3	0.3533	0.3624		3	0.3485	0.3524
	4	0.3407	0.3462		4	0.3493	0.3591		4	0.3407	0.3462
	5	0.3446	0.3493		5	0.3500	0.3657				
	6	0.3441	0.3428		6	0.3458	0.3623				

Tolerance on each Hue bin (x,y) is +/- 0.007

5700K ( $I_f = 60$ mA)											
Rank	-	x	y	Rank	-	x	y	Rank	-	x	y
J1	1	0.3215	0.3353	J3	1	0.3294	0.3306	J5	1	0.3251	0.3444
	2	0.3207	0.3462		2	0.3293	0.3364		2	0.3333	0.3518
	3	0.3292	0.3539		3	0.3331	0.3398		3	0.3332	0.3458
	4	0.3292	0.3481		4	0.3332	0.3458		4	0.3254	0.3388
	5	0.3251	0.3444		5	0.3371	0.3493				
	6	0.3254	0.3388		6	0.3366	0.3369				
J2	1	0.3222	0.3243	J4	1	0.3292	0.3539	J6	1	0.3254	0.3388
	2	0.3215	0.3353		2	0.3376	0.3616		2	0.3332	0.3458
	3	0.3254	0.3388		3	0.3371	0.3493		3	0.3331	0.3398
	4	0.3256	0.3331		4	0.3332	0.3458		4	0.3256	0.3331
	5	0.3293	0.3364		5	0.3333	0.3518				
	6	0.3294	0.3306		6	0.3292	0.3481				

Tolerance on each Hue bin (x,y) is +/- 0.007



**Light LED  
LTW-2835SZKXX Series**

6500K ( $I_f = 60$ mA)											
Rank	-	x	y	Rank	-	x	y	Rank	-	x	y
<b>K1</b>	1	0.3048	0.3209	<b>K3</b>	1	0.3145	0.3187	<b>K5</b>	1	0.3081	0.3299
	2	0.3028	0.3304		2	0.3138	0.3238		2	0.3166	0.3384
	3	0.3117	0.3393		3	0.3177	0.3277		3	0.3172	0.3330
	4	0.3124	0.3341		4	0.3172	0.3330		4	0.3089	0.3249
	5	0.3081	0.3299		5	0.3213	0.3371				
	6	0.3089	0.3249		6	0.3221	0.3261				
<b>K2</b>	1	0.3068	0.3113	<b>K4</b>	1	0.3117	0.3393	<b>K6</b>	1	0.3089	0.3249
	2	0.3048	0.3209		2	0.3205	0.3481		2	0.3172	0.3330
	3	0.3089	0.3249		3	0.3213	0.3371		3	0.3177	0.3277
	4	0.3098	0.3200		4	0.3172	0.3330		4	0.3098	0.3200
	5	0.3138	0.3238		5	0.3166	0.3384				
	6	0.3145	0.3187		6	0.3124	0.3341				

Tolerance on each Hue bin (x,y) is +/- 0.007

# Light LED LTW-2835SZKXX Series

## 5.3 Flux Bin

2700K	v Luminous Flux Spec. Table	
v Bin	Lumen (lm) at $I_F = 60$ mA	
	Min	Max
FH	21	23
HJ	23	25
JL	25	27

4000K	v Luminous Flux Spec. Table	
v Bin	Lumen (lm) at $I_F = 60$ mA	
	Min	Max
IK	24	26
KM	26	28
MO	28	30

3000K	v Luminous Flux Spec. Table	
v Bin	Lumen (lm) at $I_F = 60$ mA	
	Min	Max
GI	22	24
IK	24	26
KM	26	28

5000K	v Luminous Flux Spec. Table	
v Bin	Lumen (lm) at $I_F = 60$ mA	
	Min	Max
IK	24	26
KM	26	28
MO	28	30

3500K	v Luminous Flux Spec. Table	
v Bin	Lumen (lm) at $I_F = 60$ mA	
	Min	Max
HJ	23	25
JL	25	27
LN	27	29

5700K	v Luminous Flux Spec. Table	
v Bin	Lumen (lm) at $I_F = 60$ mA	
	Min	Max
IK	24	26
KM	26	28
MO	28	30

6500K	v Luminous Flux Spec. Table	
v Bin	Lumen (lm) at $I_F = 60$ mA	
	Min	Max
IK	24	26
KM	26	28
MO	28	30

Tolerance on each Luminous Flux bin is +/- 10%.

**Light LED  
LTW-2835SZKXX Series**

5.3 Voltage Bin

V <sub>F</sub> Spec. Table		
V <sub>F</sub> Bin	Forward Voltage (volts) at I <sub>F</sub> = 60mA	
	Min	Max
V1	2.9	3.0
V2	3.0	3.1
V3	3.1	3.2

Tolerance on each Forward Voltage bin is +/- 0.1V

6. Bin Code List

Example: V1 / HJ / D5

Forward Voltage Rank	Luminous Flux Rank	Color Rank
V1	HJ	D5

# Light LED LTW-2835SZKXX Series

## 7. Reflow Soldering Characteristics

Lead solder		Lead-free solder	
Pre-heat	120-150°C	Pre-heat	150-200°C
Pre-heat time	120 sec.Max.	Pre-heat time	120 sec.Max.
Peak Temperature	240°C Max.	Peak Temperature	260°C Max.
Soldering time condition	10 sec.Max.	Soldering time condition	10 sec.Max.

Lead Solder	Lead-free Solder
	

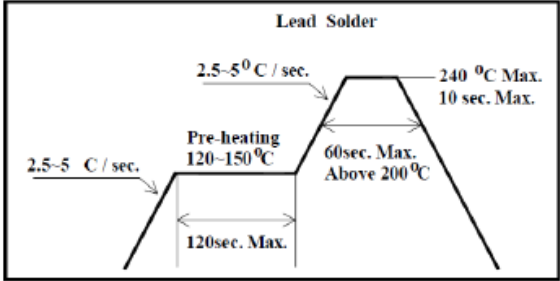
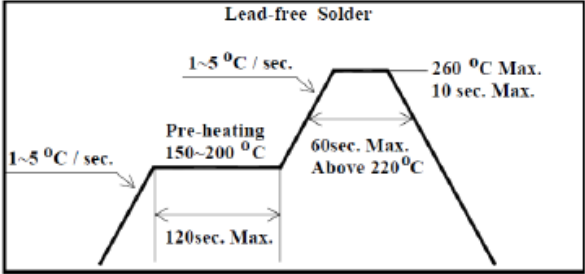
### Notes:

- The LEDs can be soldered using the reflow soldering or hand soldering method. The recommended hand soldering condition is 350 °C max. and 2 secs max. for one time only, and the recommended reflow soldering condition is as profiles above.
- All temperatures refer to topside of the package, measured on the package body surface.
- The soldering condition referring to J-STD-020. The storage ambient for the LEDs should not exceed 30 °C temperature or 70% relative humidity. It is recommended that LEDs out of their original packaging are soldered within one week. For extended storage out of their original packaging, it is recommended that the LEDs were stored in a sealed container with appropriate desiccant, or desiccators with nitrogen ambient. If the LEDs were unpacked more than 168hrs, baking the LEDs at 60 °C for 24hrs before soldering process.
- The soldering profile could be further referred to different soldering grease material characteristic. The grease vendor will provide this information.
- A rapid-rate process is not recommended for the LEDs cooling down from the peak temperature.
- Although the recommended reflow conditions are specified above, the reflow or hand soldering condition at the lowest possible temperature is desirable for the LEDs.
- The LEDs have a soft surface on the top of package. The pressure to the top surface will be influence to the reliability of the LEDs. Precautions should be taken to avoid the strong pressure on the encapsulated part. So when using the picking up nozzle, the pressure on the silicone resin should be proper.
- LiteOn cannot make a guarantee on the LEDs which have been already assembled using the dip soldering method.

## Light LED LTW-2835SZKXX Series

### 8. Reliability Test

No	Test item	Test Condition	Duration	Number of Damaged
1	Steady State Operating Life of High Temperature (HTOL)	Ts=85°C, If=80mA	1000 hrs	0/20
2	Steady State Operating Life of Low Temperature (LTOL)	Ta=-40°C, If=80mA	1000 hrs	0/20
3	Pulse Wet Operating Life of High Temperature (PWHTOL)	60°C/90%RH, If=80mA 30mins ON/30min OFF	500 hrs	0/20
4	High Temperature Storage (HTS)	100°C	1000 hrs	0/20
5	Low Temperature Storage (LTS)	-40°C	1000 hrs	0/20
6	Thermal Cycle (TC)	-40°C~100°C 30min dwell 5min transfer	200 cycle	0/20
7	Thermal Shock (TS)	-40°C~100°C 20min dwell 20sec transfer	200 cycle	0/20
8	Solder Resistance (SR)	265°C, 3X MSL	5sec	0/20
9	Solder Ability (SA)	245°C 5sec, 95% coverage	5sec	0/11
10	Mechanical Shock (MS)	1500G 0.5msec pulse shock	each 6 axis	0/6
11	Random Vibration (RV)	6G RMS, 10-2000Hz, 10min	per axis	0/6
12	Variable Vibration Frequency (VVF)	10-2000-10Hz, log or linear sweep rate, 20G for 1 min, 1.5mm each apply 3x per axis	over 6hrs	0/6
13	Salt Spread (SS)	35°C, 30g/m <sup>2</sup> /day	48hrs	0/11

#### Criteria for Judging the Damage

Item	Symbol	Test Condition	Criteria for Judgment	
			Min.	Max.
Forward Voltage	Vf	If=Typical Current		U.S.L. x 1.1
Luminous Flux	Lm	If=Typical Current	L.S.L. x 0.7	
CCX&CCY	x,y	If=Typical Current		Shift<0.02

## Light LED LTW-2835SZKXX Series

### 9. User Guide

#### ■ Cleaning

Do not use unspecified chemical liquid to clean LED they could harm the package. If cleaning is necessary, immerse the LED in ethyl alcohol or isopropyl alcohol at normal temperature for less than one minute.

#### ■ Recommend Printed Circuit Board Attachment Pad

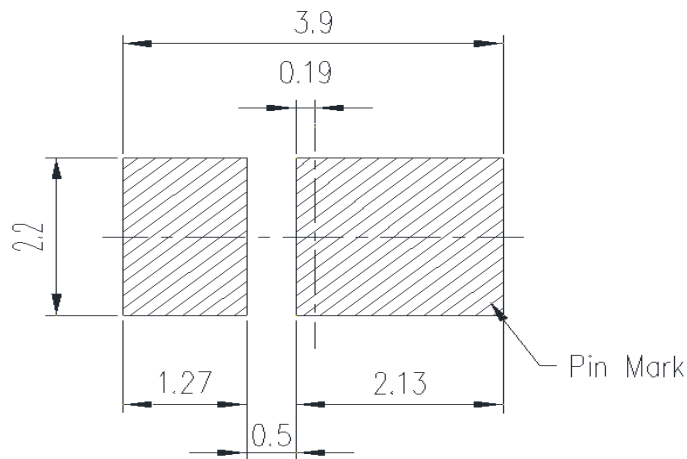

#### ■ Package Dimensions of Tape

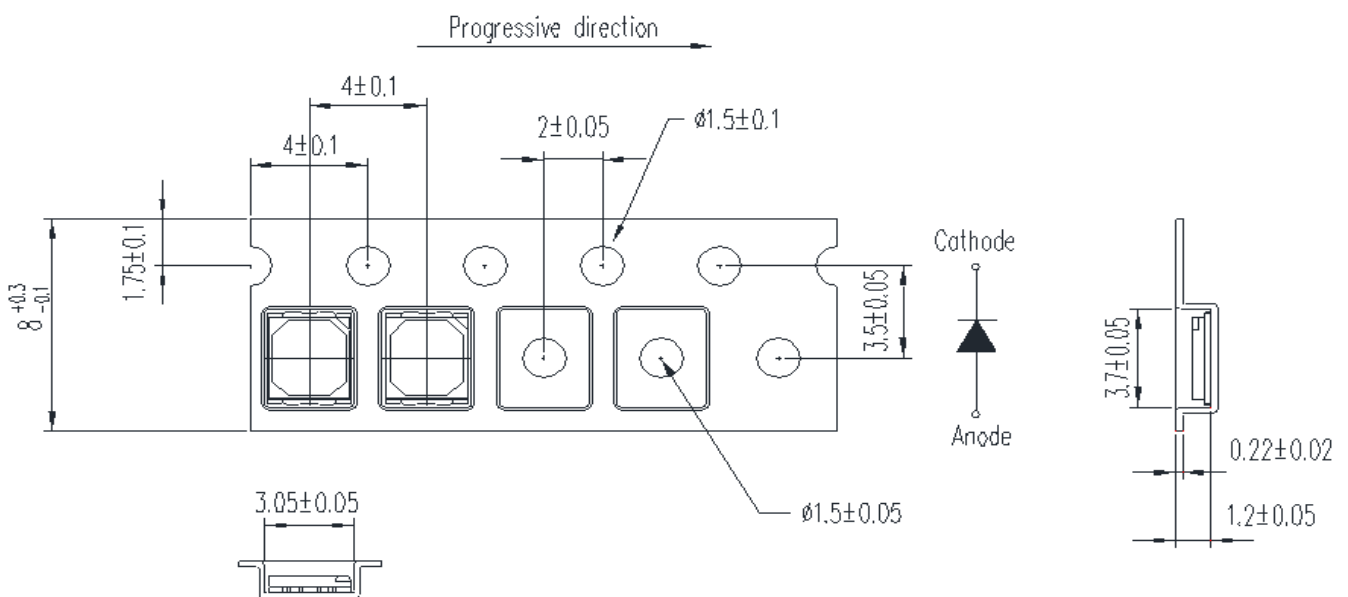

## Light LED LTW-2835SZKXX Series

### ■ Package Dimensions of Reel

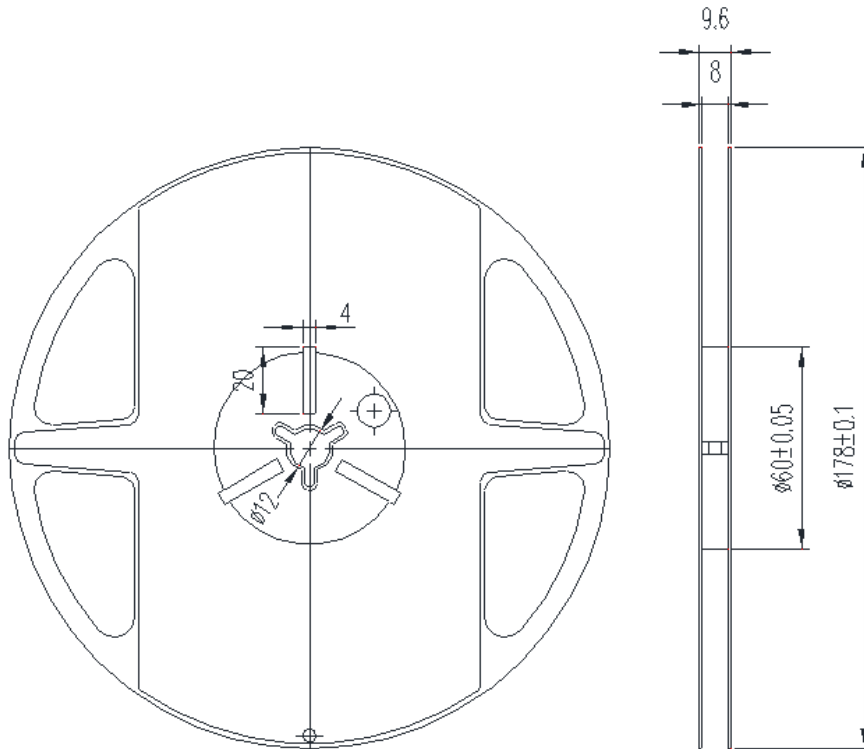

Note: The tolerances unless mentioned is  $\pm 0.1\text{mm}$ , Unit=mm

### Notes:

1. All dimensions are in millimeters.
2. Carrier: Cumulative Tolerance/10 pitches is  $\pm 0.2\text{mm}$ ; Reel: The tolerances unless mentioned is  $\pm 0.1\text{mm}$ .
3. Adhesion strength of cover tape is 0.1-0.7N when the cover tape is turned off from the carrier tape at the angle of  $10^\circ$  to the carrier tape.
4. Empty component pockets sealed with top cover tape.
5. 7 inch reel-3000 pieces per reel.
6. Minimum packing quantity is 500 pieces for remainders.

# Light LED LTW-2835SZKXX Series

## 10. Cautions

### 10.1 Application

The LEDs described here are intended to be used for ordinary electronic equipment (such as office equipment, communication equipment and household applications). Consult Liteon's Sales in advance for information on applications in which exceptional reliability is required, particularly when the failure or malfunction of the LEDs may directly jeopardize life or health (such as in aviation, transportation, traffic control equipment, medical and life support systems and safety devices).

### 10.2 Storage

This product is qualified as Moisture sensitive Level 3 per JEDEC J-STD-020 Precaution when handling this moisture sensitive product is important to ensure the reliability of the product.

The package is sealed:

The LEDs should be stored at 30°C or less and 90%RH or less. And the LEDs are limited to use within one year, while the LEDs is packed in moisture-proof package with the desiccants inside.

The package is opened:

The LEDs should be stored at 30°C or less and 60%RH or less. Moreover, the LEDs are limited to solder process within 168hrs. If exceeding the storage limiting time since opened, that we recommended to bake LEDs at 60°C at least 24hrs. To seal the remainder LEDs return to package, it's recommended to be with workable desiccants in original package.

### 10.3 Cleaning

Use alcohol-based cleaning solvents such as isopropyl alcohol to clean the LED if necessary.

### 10.4 Drive Mode

An LED is a current-operated device. In order to ensure intensity uniformity on multiple LEDs connected in parallel in an application, it is recommended that a current limiting resistor be incorporated in the drive circuit, in series with each LED as shown in Circuit A below

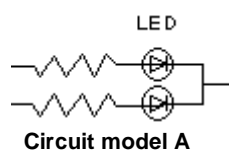

(A) Recommended circuit.

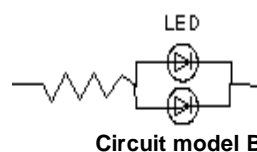



## Light LED LTW-2835SZKXX Series

(B) The brightness of each LED might appear different due to the differences in the I-V characteristics of those LEDs.

### 10.5 ESD (Electrostatic Discharge)

Static Electricity or power surge will damage the LED. Suggestions to prevent ESD damage:

- Use of a conductive wrist band or anti-electrostatic glove when handling these LEDs.
- All devices, equipment, and machinery must be properly grounded.
- Work tables, storage racks, etc. should be properly grounded.
- Use ion blower to neutralize the static charge which might have built up on surface of the LED's plastic lens as a result of friction between LEDs during storage and handling.

ESD-damaged LEDs will exhibit abnormal characteristics such as high reverse leakage current, low forward voltage, or "no lightup" at low currents. To verify for ESD damage, check for "light up" and  $V_f$  of the suspect LEDs at low currents. The  $V_f$  of "good" LEDs should be  $>2.0V@0.1mA$  for InGaN product and  $>1.4V@0.1mA$  for AlInGaP product.

### 10.6 Suggested Checking List:

- Training and Certification
  1. Everyone working in a static-safe area is ESD-certified?
  2. Training records kept and re-certification dates monitored?
- Static-Safe Workstation & Work Areas
  1. Static-safe workstation or work-areas have ESD signs?
  2. All surfaces and objects at all static-safe workstation and within 1 ft measure less than 100V?
  3. All ionizer activated, positioned towards the units?
  4. Each work surface mats grounding is good?
- Personnel Grounding
  1. Every person (including visitors) handling ESD sensitive (ESDS) items wear wrist strap, heel strap or conductive shoes with conductive flooring?
  2. If conductive footwear used, conductive flooring also present where operator stand or walk?
  3. Garments, hairs or anything closer than 1 ft to ESD items measure less than 100V\*?

## Light LED LTW-2835SZKXX Series

4. Every wrist strap or heel strap/conductive shoes checked daily and result recorded for all DLs?

5. All wrist strap or heel strap checkers calibration up to date?

Note: \*50V for Blue LED.

■ Device Handling

1. Every ESDS items identified by EIA-471 labels on item or packaging?

2. All ESDS items completely inside properly closed static-shielding containers when not at static-safe workstation?

3. No static charge generators (e.g. plastics) inside shielding containers with ESDS items?

4. All flexible conductive and dissipative package materials inspected before reuse or recycle?

■ Others

1. Audit result reported to entity ESD control coordinator?

2. Corrective action from previous audits completed?

3. Are audit records complete and on file?

### 10.7 Others:

- Do not put any pressure on the light emitting surface either by finger or any hand tool and do not stack the products. Stress or pressure may cause damage to the wires of the LED array.
- This product is not designed for the use under any of the following conditions, please confirm the performance and reliability are well enough if you use it under any of the following conditions
- Do not use sulfur-containing materials in commercial products including the materials such as seals and adhesives that may contain sulfur.
- Do not put this product in a place with a lot of moisture (over 85% relative humidity), dew condensation, briny air, and corrosive gas (Cl, H<sub>2</sub>S, NH<sub>3</sub>, SO<sub>2</sub>, NO<sub>x</sub>, etc.), exposure to a corrosive environment may affect silver plating.
- The appearance and specifications of the product may be modified for improvement without prior notice.

**Light LED  
LTW-2835SZKXX Series**

**Revision History:**

**Revision Date: 2014-9-26 (Ver -5.0)**

Last Version: (Ver -)

Version	Page	Content of Change	Date Record
1.0	19	Correct reliability item number	7/31, 2014
2.0	2, 20	Re-new outline drawing and solder pad drawing	8/6, 2014
3.0	4, 5, 21, 22	Modify typical performance, add current dependent table, and re-new carrier and tape drawing	8/27, 2014
4.0	3, 10	Modify max junction temperature, bin code revise	9/11, 2014
5.0	4	Upgrade Rth	9/26, 2014

## X-ON Electronics

Largest Supplier of Electrical and Electronic Components

*Click to view similar products for [High Power LEDs - White category](#):*

*Click to view products by [Lite-On manufacturer](#):*

Other Similar products are found below :

[G42180-08](#) [B42180-08](#) [STW8Q2PA-R5-HA](#) [SZ5-M1-W0-00-V3/W2-AA](#) [LTPL-P00DWS57](#) [LZP-D0WW00-0000](#) [CLM-9-30-90-36-AC32-F4-3](#) [SZ5-M1-WW-C8-V1/V3-FA](#) [BXRC-27E2000-D-73](#) [BXRC-27G2000-D-73](#) [BXRC-30E1000-D-73](#) [BXRC-30G2000-D-73](#) [BXRC-40E1000-D-73](#) [BXRE-30G2000-B-73](#) [BXRE-30G2000-C-73](#) [BXRE-50C2001-C-74](#) [CXM-22-27-80-54-AC30-F4-3](#) [XHP50B-00-0000-0D0UH245G](#) [XHP50B-00-0000-0D0UH240G](#) [XHP50B-00-0000-0D0UG227H](#) [XHP50B-00-0000-0D0HJ245G](#) [MP-5050-8100-27-80](#) [MP-5050-6100-65-80](#) [MP-5050-6100-50-80](#) [MP-5050-6100-40-80](#) [MP-5050-6100-30-80](#) [CXM-22-30-80-54-AC30-F4-3](#) [LTW-2835SZK57](#) [BXEM-50C0000-0-000](#) [WW-WNA30TS-U1\(M1\)](#) [KW CSLPM2.CC-8L8M-4L8N](#) [KW CSLPM2.CC-8L8M-4O9Q](#) [KW DPLS32.SB-6H6J-E5P7-EG-Z264](#) [L1V1-507003V500000](#) [CXM-22-35-80-36-AC10-F3-3](#) [KW3 CGLNM1.TG-Z6QF6-EBVFFCBB46-DFGA](#) [JB5630AWT-H-H65EA0000-NZ000001](#) [XHP50B-00-0000-0D0UG430H](#) [CXM-22-35-90-54-AC40-F5-3](#) [CXM-22-35-80-54-AC40-F5-3](#) [OSM51206E1N-0.8T](#) [OSW43020C1C](#) [MP161611032290](#) [MP-1616-2103-50-90](#) [KW CULPM1.TG-Z6RF7-ebvFfcbB46-65G5](#) [KW DMLS33.SG-Z6M7-EBVFFCBB46-8E8G-700-S](#) [XPGDWT-B1-0000-00EEA](#) [XHP70B-00-0000-0D0BP450E](#) [KW DMLN33.SG-7J7K-EBVFFCBB46-8E8G-200-S](#) [ASMT-MW05-NMNS1](#)