

# MC10H113

## Quad Exclusive OR Gate

### Description

The MC10H113 is a Quad Exclusive OR Gate with an enable common to all four gates. The outputs may be wire-ORed together to perform a 4-bit comparison function ( $A = B$ ). The enable is active LOW.

### Features

- Propagation Delay, 1.3 ns Typical
- Power Dissipation 175 mW Typ/Pkg (No Load)
- Improved Noise Margin 150 mV (Over Operating Voltage and Temperature Range)
- Voltage Compensated
- MECL 10K™ Compatible
- Pb-Free Packages are Available\*



**ON Semiconductor®**

<http://onsemi.com>

### MARKING DIAGRAMS\*

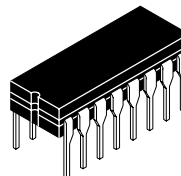

**CDIP-16  
L SUFFIX  
CASE 620A**

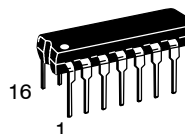
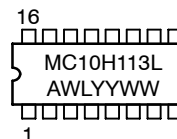

**PDIP-16  
P SUFFIX  
CASE 648**

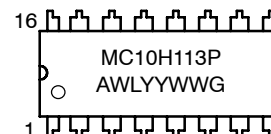

**SOEIAJ-16  
CASE 966**

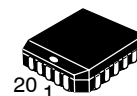
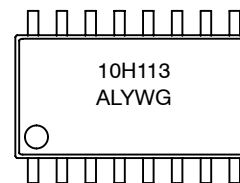

**PLLC-20  
FN SUFFIX  
CASE 775**

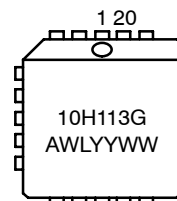

A = Assembly Location  
WL, L = Wafer Lot  
YY, Y = Year  
WW, W = Work Week  
G = Pb-Free Package

\*For additional information on our Pb-Free strategy and soldering details, please download the ON Semiconductor Soldering and Mounting Techniques Reference Manual, SOLDERRM/D.

\*For additional marking information, refer to Application Note AND8002/D.

### ORDERING INFORMATION

See detailed ordering and shipping information in the package dimensions section on page 3 of this data sheet.

# MC10H113

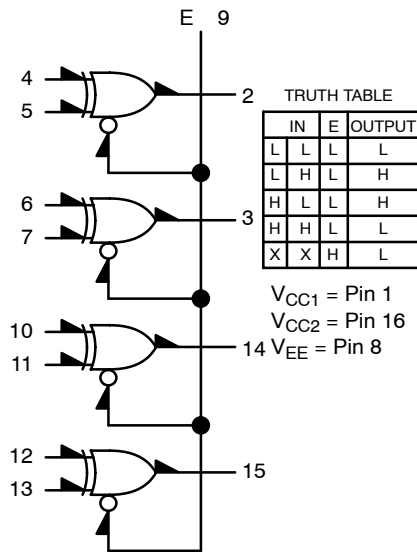
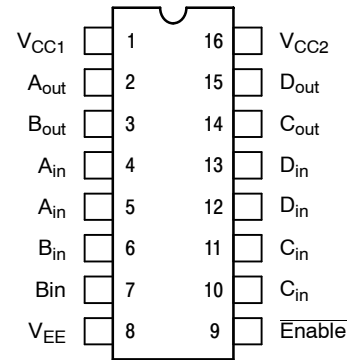

Figure 1. Logic Diagram



Pin assignment is for Dual-in-Line Package.

Figure 2. Pin Assignment

Table 1. MAXIMUM RATINGS

Symbol	Characteristic	Rating	Unit	
$V_{EE}$	Power Supply ( $V_{CC} = 0$ )	-8.0 to 0	Vdc	
$V_I$	Input Voltage ( $V_{CC} = 0$ )	0 to $V_{EE}$	Vdc	
$I_{out}$	Output Current	Continuous Surge	50 100	mA
$T_A$	Operating Temperature Range	0 to +75	°C	
$T_{stg}$	Storage Temperature Range	Plastic Ceramic	-55 to +150 -55 to +165	°C °C

Maximum ratings are those values beyond which device damage can occur. Maximum ratings applied to the device are individual stress limit values (not normal operating conditions) and are not valid simultaneously. If these limits are exceeded, device functional operation is not implied, damage may occur and reliability may be affected.

Table 2. ELECTRICAL CHARACTERISTICS ( $V_{EE} = -5.2\text{ V} \pm 5\%$ ) (Note 1)

Symbol	Characteristic	0°		25°		75°		Unit
		Min	Max	Min	Max	Min	Max	
$I_E$	Power Supply Current	-	46	-	42	-	46	mA
$I_{inH}$	Input Current High							$\mu\text{A}$
	Pins 5, 7, 11, 13	-	430	-	270	-	270	
	Pins 4, 6, 10, 12	-	510	-	320	-	320	
	Pin 9	-	1100	-	740	-	740	
$I_{inL}$	Input Current Low	0.5	-	0.5	-	0.3	-	$\mu\text{A}$
$V_{OH}$	High Output Voltage	-1.02	-0.84	-0.98	-0.81	-0.92	-0.735	Vdc
$V_{OL}$	Low Output Voltage	-1.95	-1.63	-1.95	-1.63	-1.95	-1.60	Vdc
$V_{IH}$	High Input Voltage	-1.17	-0.84	-1.13	-0.81	-1.07	-0.735	Vdc
$V_{IL}$	Low Input Voltage	-1.95	-1.48	-1.95	-1.48	-1.95	-1.45	Vdc

1. Each MECL 10H™ series circuit has been designed to meet the dc specifications shown in the test table, after thermal equilibrium has been established. The circuit is in a test socket or mounted on a printed circuit board and transverse air flow greater than 500 linear fpm is maintained. Outputs are terminated through a 50  $\Omega$  resistor to -2.0 V.

# MC10H113

**Table 3. AC CHARACTERISTICS**

Symbol	Characteristic	0°		25°		75°		Unit
		Min	Max	Min	Max	Min	Max	
t <sub>pd</sub>	Propagation Delay							ns
	Data	0.4	1.7	0.4	1.8	0.5	1.9	
	Enable	0.5	2.3	0.5	2.4	0.6	2.5	
t <sub>r</sub>	Rise Time	0.5	1.8	0.6	1.9	0.6	2.0	ns
t <sub>f</sub>	Fall Time	0.5	1.8	0.6	1.9	0.6	2.0	ns

NOTE: Device will meet the specifications after thermal equilibrium has been established when mounted in a test socket or printed circuit board with maintained transverse airflow greater than 500 lfpm. Electrical parameters are guaranteed only over the declared operating temperature range. Functional operation of the device exceeding these conditions is not implied. Device specification limit values are applied individually under normal operating conditions and not valid simultaneously.

## ORDERING INFORMATION

Device	Package	Shipping <sup>†</sup>
MC10H113FN	PLLC-20	46 Units / Rail
MC10H113FNG	PLLC-20 (Pb-Free)	46 Units / Rail
MC10H113FNR2	PLLC-20	500 / Tape & Reel
MC10H113FNR2G	PLLC-20 (Pb-Free)	500 / Tape & Reel
MC10H113L	CDIP-16	25 Unit / Rail
MC10H113M	SOEIAJ-16	50 Unit / Rail
MC10H113MG	SOEIAJ-16 (Pb-Free)	50 Unit / Rail
MC10H113MEL	SOEIAJ-16	2000 / Tape & Reel
MC10H113MELG	SOEIAJ-16 (Pb-Free)	2000 / Tape & Reel
MC10H113P	PDIP-16	25 Unit / Rail
MC10H113PG	PDIP-16 (Pb-Free)	25 Unit / Rail

<sup>†</sup>For information on tape and reel specifications, including part orientation and tape sizes, please refer to our Tape and Reel Packaging Specifications Brochure, BRD8011/D.

# MC10H113

## PACKAGE DIMENSIONS

20 LEAD PLLC  
CASE 775-02  
ISSUE E



- NOTES:
1. DIMENSIONS AND TOLERANCING PER ANSI Y14.5M, 1982.
  2. DIMENSIONS IN INCHES.
  3. DATUMS -L-, -M-, AND -N- DETERMINED WHERE TOP OF LEAD SHOULDER EXITS PLASTIC BODY AT MOLD PARTING LINE.
  4. DIMENSION G1, TRUE POSITION TO BE MEASURED AT DATUM -T-, SEATING PLANE.
  5. DIMENSIONS R AND U DO NOT INCLUDE MOLD FLASH. ALLOWABLE MOLD FLASH IS 0.010 (0.250) PER SIDE.
  6. DIMENSIONS IN THE PACKAGE TOP MAY BE SMALLER THAN THE PACKAGE BOTTOM BY UP TO 0.012 (0.300). DIMENSIONS R AND U ARE DETERMINED AT THE OUTERMOST EXTREMES OF THE PLASTIC BODY EXCLUSIVE OF MOLD FLASH, TIE BAR BURRS, GATE BURRS AND INTERLEAD FLASH, BUT INCLUDING ANY MISMATCH BETWEEN THE TOP AND BOTTOM OF THE PLASTIC BODY.
  7. DIMENSION H DOES NOT INCLUDE DAMBAR PROTRUSION OR INTRUSION. THE DAMBAR PROTRUSION(S) SHALL NOT CAUSE THE H DIMENSION TO BE GREATER THAN 0.037 (0.940). THE DAMBAR INTRUSION(S) SHALL NOT CAUSE THE H DIMENSION TO BE SMALLER THAN 0.025 (0.635).

DIM	INCHES		MILLIMETERS	
	MIN	MAX	MIN	MAX
A	0.385	0.395	9.78	10.03
B	0.385	0.395	9.78	10.03
C	0.165	0.180	4.20	4.57
E	0.090	0.110	2.29	2.79
F	0.013	0.019	0.33	0.48
G	0.050 BSC		1.27 BSC	
H	0.026	0.032	0.66	0.81
J	0.020	---	0.51	---
K	0.025	---	0.64	---
R	0.350	0.356	8.89	9.04
U	0.350	0.356	8.89	9.04
V	0.042	0.048	1.07	1.21
W	0.042	0.048	1.07	1.21
X	0.042	0.056	1.07	1.42
Y	---	0.020	---	0.50
Z	2° 10°		2° 10°	
G1	0.310	0.330	7.88	8.38
K1	0.040	---	1.02	---

# MC10H113

## PACKAGE DIMENSIONS

### SOEIAJ-16 CASE 966-01 ISSUE A



NOTES:

1. DIMENSIONING AND TOLERANCING PER ANSI Y14.5M, 1982.
2. CONTROLLING DIMENSION: MILLIMETER.
3. DIMENSIONS D AND E DO NOT INCLUDE MOLD FLASH OR PROTRUSIONS AND ARE MEASURED AT THE PARTING LINE. MOLD FLASH OR PROTRUSIONS SHALL NOT EXCEED 0.15 (0.006) PER SIDE.
4. TERMINAL NUMBERS ARE SHOWN FOR REFERENCE ONLY.
5. THE LEAD WIDTH DIMENSION (b) DOES NOT INCLUDE DAMBAR PROTRUSION. ALLOWABLE DAMBAR PROTRUSION SHALL BE 0.08 (0.003) TOTAL IN EXCESS OF THE LEAD WIDTH DIMENSION AT MAXIMUM MATERIAL CONDITION. DAMBAR CANNOT BE LOCATED ON THE LOWER RADIUS OR THE FOOT. MINIMUM SPACE BETWEEN PROTRUSIONS AND ADJACENT LEAD TO BE 0.46 (0.018).

DIM	MILLIMETERS		INCHES	
	MIN	MAX	MIN	MAX
A	---	2.05	---	0.081
A <sub>1</sub>	0.05	0.20	0.002	0.008
b	0.35	0.50	0.014	0.020
c	0.10	0.20	0.007	0.011
D	9.90	10.50	0.390	0.413
E	5.10	5.45	0.201	0.215
e	1.27 BSC			
HE	7.40	8.20	0.291	0.323
L	0.50	0.85	0.020	0.033
LE	1.10	1.50	0.043	0.059
M	0°	10°	0°	10°
Q <sub>1</sub>	0.70	0.90	0.028	0.035
Z	---	0.78	---	0.031

### CDIP-16 L SUFFIX CERAMIC DIP PACKAGE CASE 620A-01 ISSUE O



NOTES:

1. DIMENSIONING AND TOLERANCING PER ASME Y14.5M, 1994.
2. CONTROLLING DIMENSION: INCH.
3. DIMENSION L TO CENTER OF LEAD WHEN FORMED PARALLEL.
4. DIMENSION F MAY NARROW TO 0.76 (0.030) WHERE THE LEAD ENTERS THE CERAMIC BODY.
5. THIS DRAWING REPLACES OBSOLETE CASE OUTLINE 620-10.

DIM	INCHES		MILLIMETERS	
	MIN	MAX	MIN	MAX
A	0.750	0.785	19.05	19.93
B	0.240	0.295	6.10	7.49
C	---	0.200	---	5.08
D	0.015	0.020	0.39	0.50
E	0.050 BSC			
F	0.055	0.065	1.40	1.65
G	0.100 BSC			
H	0.008	0.015	0.21	0.38
K	0.125	0.170	3.18	4.31
L	0.300 BSC			
M	0°	15°	0°	15°
N	0.020	0.040	0.51	1.01

# MC10H113

## PACKAGE DIMENSIONS

### PDIP-16 P SUFFIX PLASTIC DIP PACKAGE CASE 648-08 ISSUE R



#### NOTES:

1. DIMENSIONING AND TOLERANCING PER ANSI Y14.5M, 1982.
2. CONTROLLING DIMENSION: INCH.
3. DIMENSION L TO CENTER OF LEADS WHEN FORMED PARALLEL.
4. DIMENSION B DOES NOT INCLUDE MOLD FLASH.
5. ROUNDED CORNERS OPTIONAL.

DIM	INCHES		MILLIMETERS	
	MIN	MAX	MIN	MAX
A	0.740	0.770	18.80	19.55
B	0.250	0.270	6.35	6.85
C	0.145	0.175	3.69	4.44
D	0.015	0.021	0.39	0.53
F	0.040	0.70	1.02	1.77
G	0.100 BSC		2.54 BSC	
H	0.050 BSC		1.27 BSC	
J	0.008	0.015	0.21	0.38
K	0.110	0.130	2.80	3.30
L	0.295	0.305	7.50	7.74
M	0°	10°	0°	10°
S	0.020	0.040	0.51	1.01

MECL 10H and MECL 10K are trademarks of Motorola, Inc.

ON Semiconductor and are registered trademarks of Semiconductor Components Industries, LLC (SCILLC). SCILLC reserves the right to make changes without further notice to any products herein. SCILLC makes no warranty, representation or guarantee regarding the suitability of its products for any particular purpose, nor does SCILLC assume any liability arising out of the application or use of any product or circuit, and specifically disclaims any and all liability, including without limitation special, consequential or incidental damages. "Typical" parameters which may be provided in SCILLC data sheets and/or specifications can and do vary in different applications and actual performance may vary over time. All operating parameters, including "Typicals" must be validated for each customer application by customer's technical experts. SCILLC does not convey any license under its patent rights nor the rights of others. SCILLC products are not designed, intended, or authorized for use as components in systems intended for surgical implant into the body, or other applications intended to support or sustain life, or for any other application in which the failure of the SCILLC product could create a situation where personal injury or death may occur. Should Buyer purchase or use SCILLC products for any such unintended or unauthorized application, Buyer shall indemnify and hold SCILLC and its officers, employees, subsidiaries, affiliates, and distributors harmless against all claims, costs, damages, and expenses, and reasonable attorney fees arising out of, directly or indirectly, any claim of personal injury or death associated with such unintended or unauthorized use, even if such claim alleges that SCILLC was negligent regarding the design or manufacture of the part. SCILLC is an Equal Opportunity/Affirmative Action Employer. This literature is subject to all applicable copyright laws and is not for resale in any manner.

#### PUBLICATION ORDERING INFORMATION

**LITERATURE FULFILLMENT:**  
Literature Distribution Center for ON Semiconductor  
P.O. Box 61312, Phoenix, Arizona 85082-1312 USA  
**Phone:** 480-829-7710 or 800-344-3860 Toll Free USA/Canada  
**Fax:** 480-829-7709 or 800-344-3867 Toll Free USA/Canada  
**Email:** orderlit@onsemi.com

**N. American Technical Support:** 800-282-9855 Toll Free  
USA/Canada

**Japan:** ON Semiconductor, Japan Customer Focus Center  
2-9-1 Kamimeguro, Meguro-ku, Tokyo, Japan 153-0051  
**Phone:** 81-3-5773-3850

**ON Semiconductor Website:** <http://onsemi.com>

**Order Literature:** <http://www.onsemi.com/litorder>

For additional information, please contact your local Sales Representative.

## X-ON Electronics

Largest Supplier of Electrical and Electronic Components

*Click to view similar products for [Gate Drivers](#) category:*

*Click to view products by [ON Semiconductor](#) manufacturer:*

Other Similar products are found below :

[00028](#) [00053P0231](#) [8967380000](#) [56956](#) [CR7E-30DB-3.96E\(72\)](#) [57.404.7355.5](#) [LT4936](#) [57.904.0755.0](#) [5801-0903](#) [5803-0901](#) [5811-0902](#)  
[5813-0901](#) [58410](#) [00576P0030](#) [00581P0070](#) [5882900001](#) [00103P0020](#) [00600P0005](#) [00-9050-LRPP](#) [00-9090-RDPP](#) [5951900000](#) [01-](#)  
[1003W-10/32-15](#) [LTLA6E-1S-WH-RC-FN12VXCR1](#) [0131700000](#) [00-2240](#) [LTP70N06](#) [LVP640](#) [0158-624-00](#) [5J0-1000LG-SIL](#) [020017-13](#)  
[LY1D-2-5S-AC120](#) [LY2-0-US-AC120](#) [LY2-US-AC240](#) [LY3-UA-DC24](#) [00-5150](#) [00576P0020](#) [00600P0010](#) [LZNQ2M-US-DC5](#) [LZNQ2-](#)  
[US-DC12](#) [LZP40N10](#) [00-8196-RDPP](#) [00-8274-RDPP](#) [00-8275-RDNP](#) [00-8609-RDPP](#) [00-8722-RDPP](#) [00-8728-WHPP](#) [00-8869-RDPP](#) [00-](#)  
[9051-RDPP](#) [00-9091-LRPP](#) [00-9291-RDPP](#)