

| PART NUMBER | DESCRIPTION                        |
|-------------|------------------------------------|
| CCS-32      | Commercial Failsafe SPDT, DC-12GHz |
| CS-32       | Elite Failsafe SPDT, DC-12GHz      |

The CCS-32/CS-32 is a broadband, SPDT, electromechanical, coaxial switch designed to switch a microwave signal from a common input to either of two outputs. The characteristic impedance is 50 Ohms. The small switches incorporate Type N or TNC connectors. The CCS-32/CS-32 series switch is offered with a failsafe actuator. This design is compatible with the two most common mounting hole patterns. The CCS-32/CS-32 series switch is interchangeable with a variety of switches.



| ENVIRONMENTAL AND PHYSICAL CHARACTERISTICS                     |                       |
|----------------------------------------------------------------|-----------------------|
| Operating Temperature                                          |                       |
| Commercial Model, CCS-32                                       | -40°C to 65°C         |
| Elite Model, CS-32                                             | -55°C to 85°C         |
| Vibration (MIL-STD-202 Method 214, Condition D, non-operating) | 10 g's RMS            |
| Shock (MIL-STD-202 Method 213, Condition D, non-operating)     | 500 g's               |
| Standard Actuator Life                                         | 2,000,000 cycles      |
| Actuator Life w/ Additional Features                           | 1,000,000 cycles      |
| Connector Type                                                 | Type N or TNC         |
| Humidity (Moisture Seal)                                       | Available             |
| Weight                                                         | 6 oz. (170.1g) (max.) |

| ELECTRICAL CHARACTERISTICS        |                         |
|-----------------------------------|-------------------------|
| Form Factor                       | SPDT, break before make |
| Frequency Range                   |                         |
| CCS-32                            | DC–12 GHz               |
| CS-32                             | DC–12 GHz               |
| Characteristic Impedance          | 50 Ohms                 |
| Operate Time                      | 10 ms (max.)            |
| Release Time                      | 10 ms (max.)            |
| Actuation Voltage Available       | 12 15 24 28 V           |
| Actuation Current, max. @ ambient | 600 500 300 250 mA      |
| RF Power Handling                 | 1.1 kW CW @ 1.1 GHz     |

| TYPICAL PERFORMANCE CHARACTERISTICS: N CONNECTOR OPTION (TNC CONNECTOR, 11GHz MAX.) |          |         |         |          |
|-------------------------------------------------------------------------------------|----------|---------|---------|----------|
| Frequency                                                                           | DC–3 GHz | 3–6 GHz | 6–9 GHz | 9–12 GHz |
| Insertion Loss, dB, typical.                                                        | 0.2      | 0.2     | 0.4     | 0.4      |
| Isolation, dB, typical.                                                             | 70       | 70      | 70      | 50       |
| VSWR, typical.                                                                      | 1.2:1    | 1.2:1   | 1.3:1   | 1.3:1    |

For maximum limits, please see charts on page 3-5

**PART NUMBERING SYSTEM**

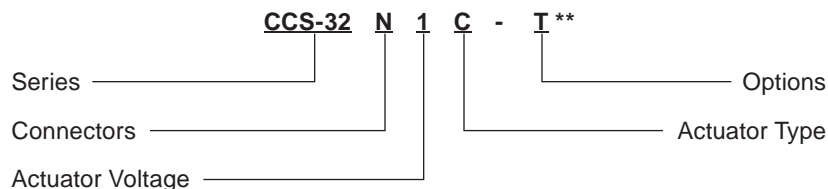

- Connector**  
**N:** Type N Female  
**T:** TNC Female  
**HN:** High Power Type N Female  
**HT:** High Power TNC Female

- Actuator Voltage**  
 1: 28 Vdc Failsafe  
 2: 15 Vdc Failsafe  
 3: 12 Vdc Failsafe  
 4: 24 Vdc Failsafe

- Actuator Type**  
 0: Standard Contacts  
 C: Indicator Contacts

- Options**  
 T: TTL Drivers with Diodes  
 D: Transient Suppression Diodes  
 M: Moisture Seal  
 S: 9 Pin D-Sub Connector

For other options, contact factory.

\*\*SEE PARTS LIST ON PAGE 8-9

**SCHEMATICS AND MECHANICAL OUTLINE**

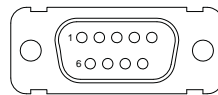
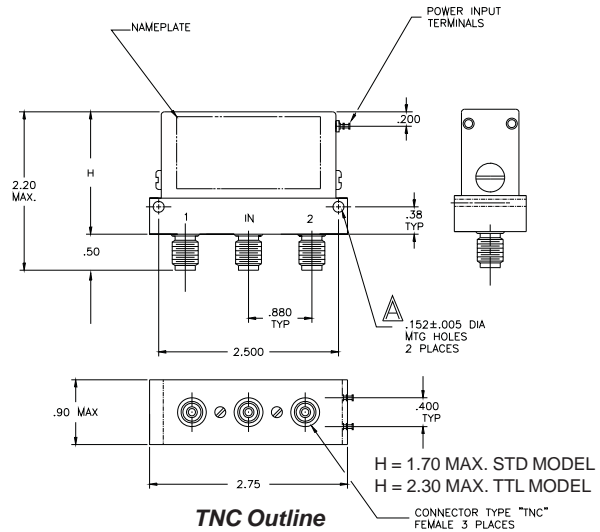
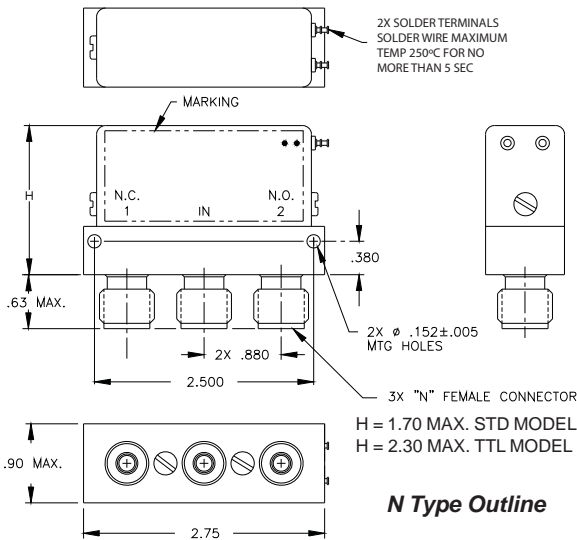
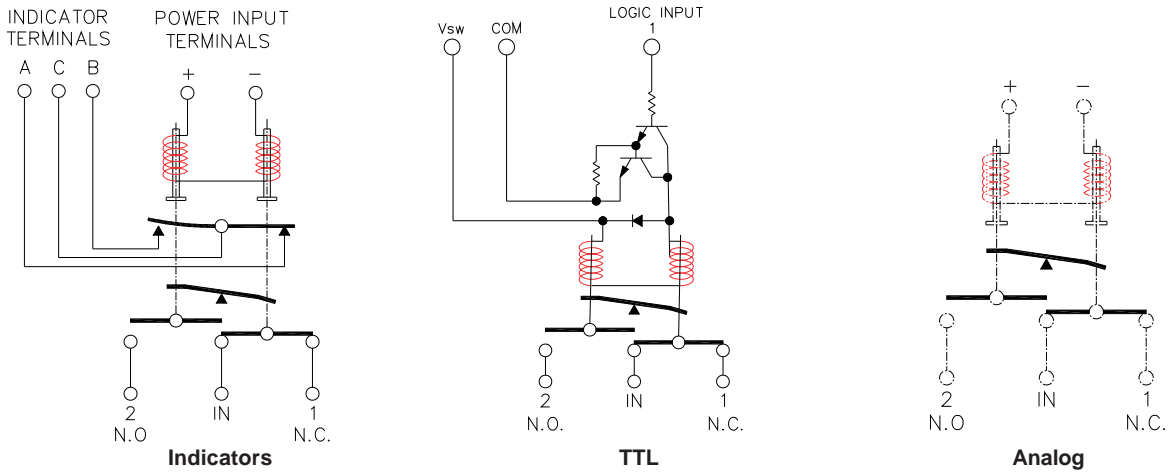

**"-S OPTION" 9-PIN D-SUB CONNECTOR (EXAMPLE: CCS-32N10-S)**

| 9 PIN D-SUB PINOUT FOR FAILSAFE SPDT |         |            |        |                  |
|--------------------------------------|---------|------------|--------|------------------|
| Pin No.                              | OPTIONS |            |        |                  |
|                                      | Basic   | Indicators | TTL    | Indicators & TTL |
| 1                                    | +       | +          |        |                  |
| 2                                    | -       | -          |        |                  |
| 3                                    |         |            | Common | Common           |
| 4                                    |         |            | 1      | 1                |
| 5                                    |         |            |        |                  |
| 6                                    |         |            | Vsw    | Vsw              |
| 7                                    |         | A          |        | A                |
| 8                                    |         | B          |        | B                |
| 9                                    |         | C          |        | C                |

| TRUTH TABLE (with TTL option) |         |         |                           |   |
|-------------------------------|---------|---------|---------------------------|---|
| Logic Input                   | RF Path |         | Indicator (if applicable) |   |
|                               | IN to 1 | IN to 2 | A                         | B |
| 0                             | On      | Off     | C                         | 0 |
| 1                             | Off     | On      | 0                         | C |

**TYPICAL NARROWBAND RF INSERTION LOSS PERFORMANCE CURVES**

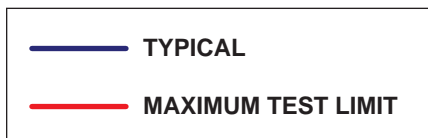
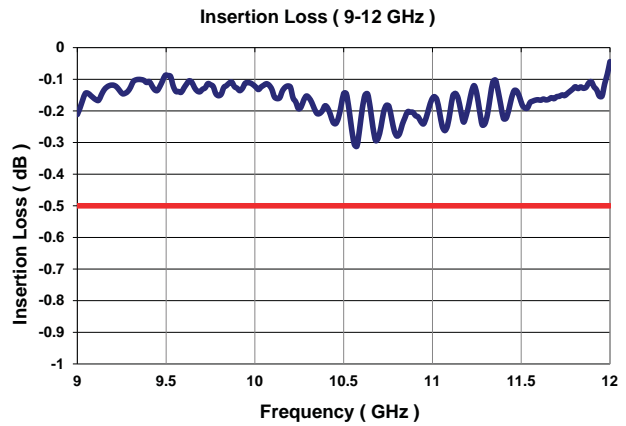
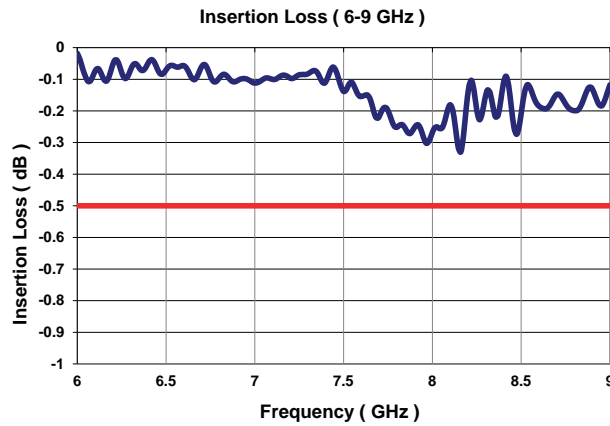
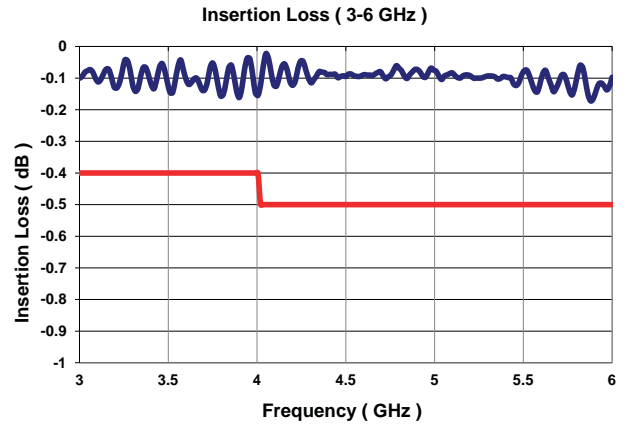
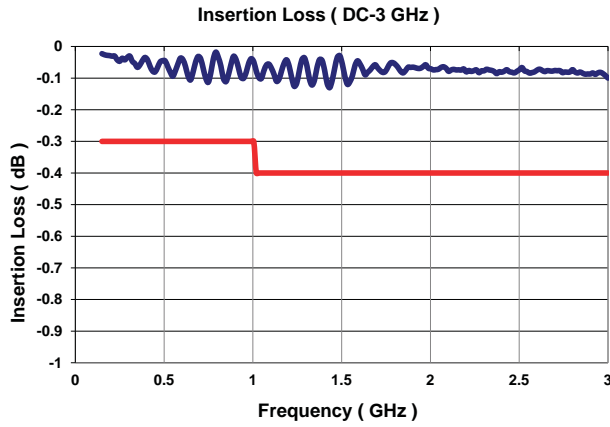

# Series CCS-32/CS-32

High Power DC–12 GHz

Failsafe SPDT Coaxial Switch



**TELEDYNE**  
**COAX SWITCHES**  
Everywhere you look™

## TYPICAL NARROWBAND RF ISOLATION PERFORMANCE CURVES

Isolation ( DC-3 GHz )

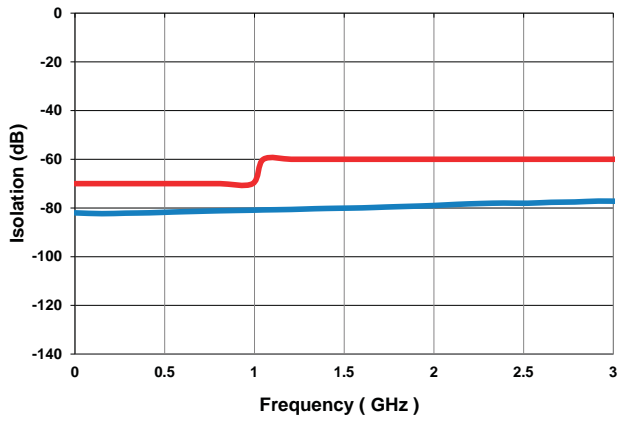

Isolation ( 3-6 GHz )

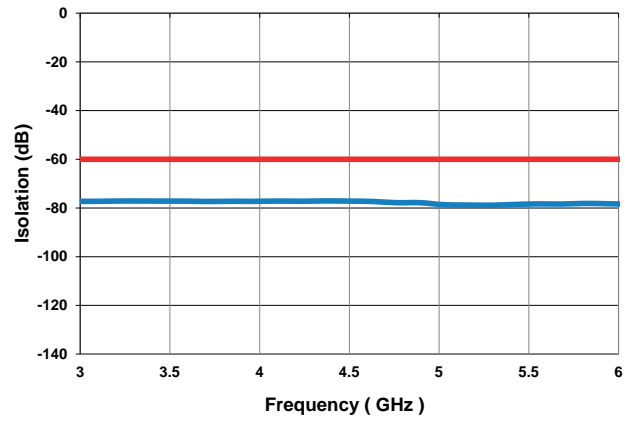

Isolation ( 6-9 GHz )

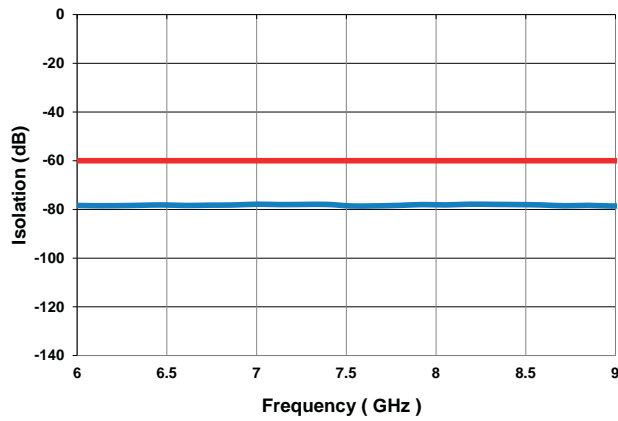

Isolation ( 9-12 GHz )

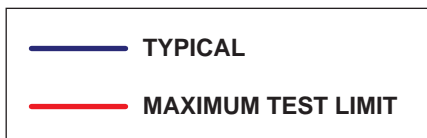
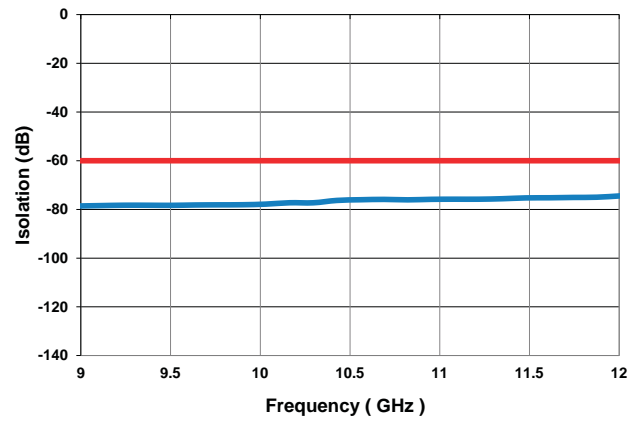

**TYPICAL NARROWBAND RF VSWR PERFORMANCE CURVES**

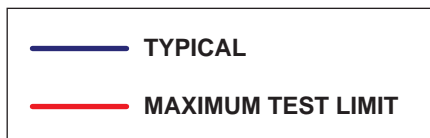
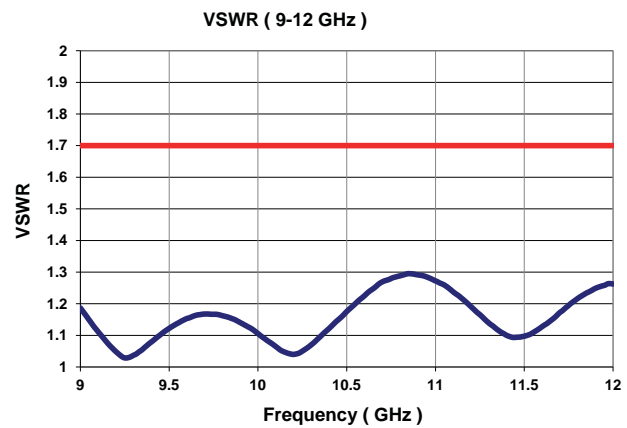
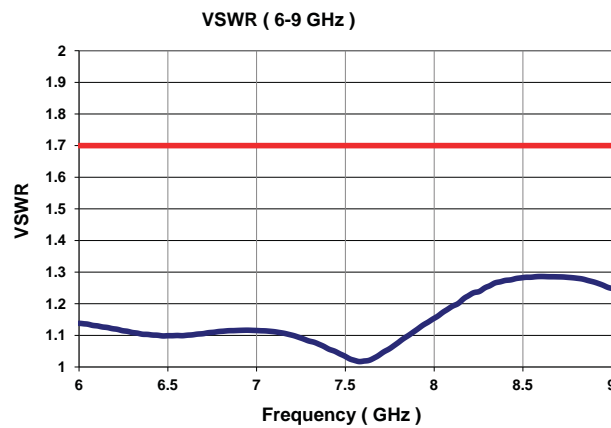
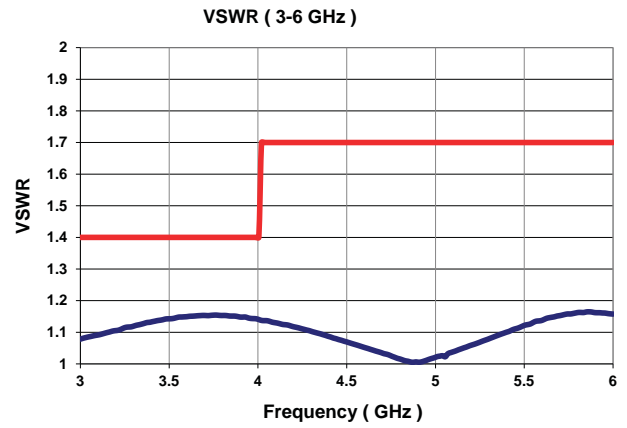
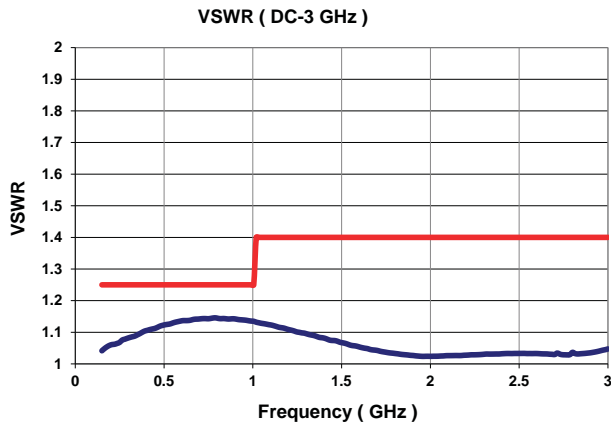

**TYPICAL POWER PERFORMANCE CURVE**

# Power Handling vs. Frequency

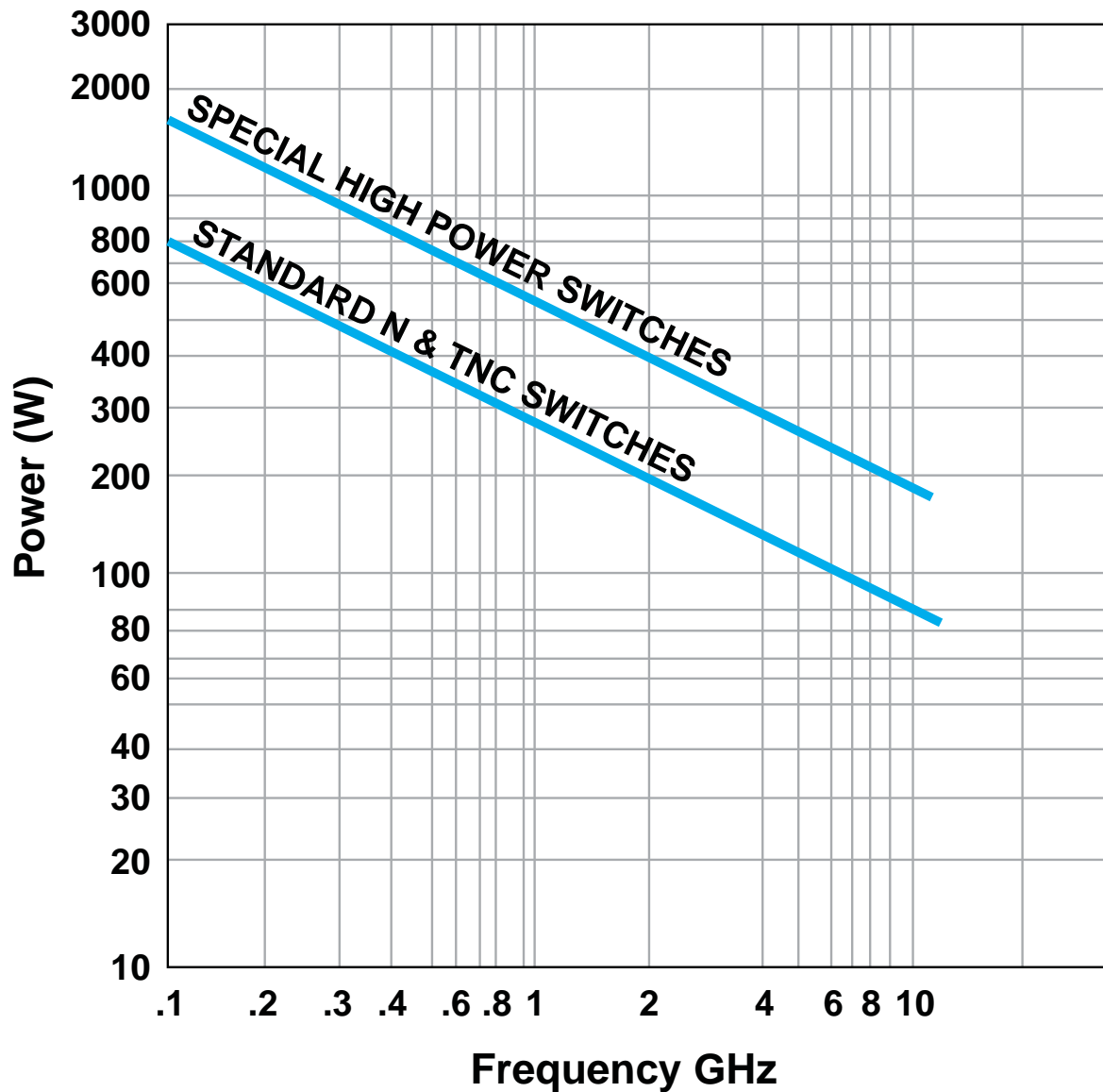

Estimates based on the following reference conditions:

- Ambient temperature of 40°C or less
- Sea level operation
- Load VSWR of 1.20:1 maximum
- No high-power (hot) switching

Please contact Teledyne Coax Switches for derating factors when applications do not meet the foregoing reference conditions.

**GLOSSARY**

**Actuator**

An actuator is the electromechanical mechanism that transfers the RF contacts from one position to another upon DC command.

**Arc Suppression Diode**

A diode is connected in parallel with the coil. This diode limits the “reverse EMF spike” generated when the coil de-energizes to 0.7 volts. The diode cathode is connected to the positive side of the coil and the anode is connected to the negative side.

**Date Code**

All switches are marked with either a unique serial number or a date code. Date codes are in accordance with MIL-STD-1285 Paragraph 5.2.5 and consist of four digits. The first two digits define the year and the last two digits define the week of the year (YYWW). Thus, 1032 identifies switches that passed through final inspection during the 32nd week of 2010.

**Failsafe**

A failsafe switch reverts to the default or failsafe position when actuating voltage is removed. This is realized by a return spring within the drive mechanism. This type of switch requires the continuous application of operating voltage to select and hold any position. (Multi-position switches are normally open with no voltage applied).

**Indicator**

Indicators tell the system which position the switch is in. Other names for indicators are telemetry contacts or tellback circuit. Indicators are usually a set of internally mounted DC contacts linked to the actuator. They can be wired to digital input lines, status lights, or interlocks. Unless otherwise specified, the maximum indicator contact rating is 30 Vdc, 50 mA, or 1.5 Watts into a resistive load.

**Isolation**

Isolation is the measure of the power level at the output connector of an unconnected RF channel as referenced to the power at the input connector. It is specified in dB below the input power level.

**SPDT Switch**

A single-pole double-throw, bi-directional switch that can be used as having one input and two outputs or two inputs and one output.

**Switching Time**

Switching time is the total interval beginning with the arrival of the leading edge of the command pulse at the switch DC input and ending with the completion of the switch transfer, including contact bounce. It consists of three parts: (1) inductive delay in the coil, (2) transfer time of the physical movement of the contacts, and (3) the bounce time of the RF contacts.

**TTL Switch Driver Option**

As a special option, switch drivers can be provided for both failsafe and latching switches, which are compatible with industry-standard low-power Schottky TTL circuits.

**Performance Parameters vs Frequency**

Generally speaking, the RF performance of coaxial switches is frequency dependent. With increasing frequency, VSWR and insertion loss increase while isolation decreases. All data sheets specify these three parameters as “worst case” at the highest operating frequency. If the switch is to be used over a narrow frequency band, better performance can be achieved.

**Actuator Current vs Temperature**

The resistance of the actuator coil varies as a function of temperature. There is an inverse relationship between the operating temperature of the switch and the actuator drive current. For switches operating at 28 VDC, the approximate actuator drive current at temperature, T, can be calculated using the equation:

$$I_T = \frac{I_A}{[1 + .00385 (T-20)]}$$

Where:

$I_T$  = Actuator current at temperature, T

$I_A$  = Room temperature actuator current – see data sheet

T = Temperature of interest in °C

**Magnetic Sensitivity**

An electro-mechanical switch can be sensitive to ferrous materials and external magnetic fields. Neighboring ferrous materials should be permitted no closer than 0.5 inches and adjacent external magnetic fields should be limited to a flux density of less than 5 Gauss.

**SPECIAL FEATURE**

**Switching High-Power or Highly Sensitive Signals**

Ensure the most linear response with the best galvanically matched contact system in the industry. Extremely low passive intermodulation is standard on all of our switches.

| Carrier Frequency 1 | Carrier Frequency 2 | PIM 3rd Order Frequency | PIM 5th Order Frequency |
|---------------------|---------------------|-------------------------|-------------------------|
| 870 MHz             | 893 MHz             | 847 MHz                 | 824 MHz                 |

|      | 3rd Order Intermodulation | 5th Order Intermodulation |
|------|---------------------------|---------------------------|
| SPDT | -91 dBm                   | -110 dBm                  |
|      | -134 dBc                  | -153 dBc                  |

# Series CCS-32/CS-32

High Power DC–12 GHz  
Failsafe SPDT Coaxial Switch



## FAILSAFE CCS-32N/CS-32N/ • CCS-32T/CS-32T PART NUMBER LIST

|    | PART No.      |    | PART No.      |     | PART No.        |     | PART No.        |
|----|---------------|----|---------------|-----|-----------------|-----|-----------------|
| 1  | CCS-32NXC     | 43 | CS-32NX0-MS   | 85  | CS-32TX0        | 127 | CS-32HNXC-MS    |
| 2  | CCS-32NXC-D   | 44 | CS-32NX0-S    | 86  | CS-32TX0-D      | 128 | CS-32HNXC-S     |
| 3  | CCS-32NXC-DM  | 45 | CS-32NX0-T    | 87  | CS-32TX0-DM     | 129 | CS-32HNXC-T     |
| 4  | CCS-32NXC-DMS | 46 | CS-32NX0-TM   | 88  | CS-32TX0-DMS    | 130 | CS-32HNXC-TM    |
| 5  | CCS-32NXC-DS  | 47 | CS-32NX0-TMS  | 89  | CS-32TX0-DS     | 131 | CS-32HNXC-TMS   |
| 6  | CCS-32NXC-M   | 48 | CS-32NX0-TS   | 90  | CS-32TX0-M      | 132 | CS-32HNXC-TS    |
| 7  | CCS-32NXC-MS  | 49 | CCS-32TXC     | 91  | CS-32TX0-MS     | 133 | CS-32HNXC0      |
| 8  | CCS-32NXC-S   | 50 | CCS-32TXC-D   | 92  | CS-32TX0-S      | 134 | CS-32HNXC0-D    |
| 9  | CCS-32NXC-T   | 51 | CCS-32TXC-DM  | 93  | CS-32TX0-T      | 135 | CS-32HNXC0-DM   |
| 10 | CCS-32NXC-TM  | 52 | CCS-32TXC-DMS | 94  | CS-32TX0-TM     | 136 | CS-32HNXC0-DMS  |
| 11 | CCS-32NXC-TMS | 53 | CCS-32TXC-DS  | 95  | CS-32TX0-TMS    | 137 | CS-32HNXC0-DS   |
| 12 | CCS-32NXC-TS  | 54 | CCS-32TXC-M   | 96  | CS-32TX0-TS     | 138 | CS-32HNXC0-M    |
| 13 | CCS-32NX0     | 55 | CCS-32TXC-MS  | 97  | CCS-32HNXC      | 139 | CS-32HNXC0-MS   |
| 14 | CCS-32NX0-D   | 56 | CCS-32TXC-S   | 98  | CCS-32HNXC-D    | 140 | CS-32HNXC0-S    |
| 15 | CCS-32NX0-DM  | 57 | CCS-32TXC-T   | 99  | CCS-32HNXC-DM   | 141 | CS-32HNXC0-T    |
| 16 | CCS-32NX0-DMS | 58 | CCS-32TXC-TM  | 100 | CCS-32HNXC-DMS  | 142 | CS-32HNXC0-TM   |
| 17 | CCS-32NX0-DS  | 59 | CCS-32TXC-TMS | 101 | CCS-32HNXC-DS   | 143 | CS-32HNXC0-TMS  |
| 18 | CCS-32NX0-M   | 60 | CCS-32TXC-TS  | 102 | CCS-32HNXC-M    | 144 | CS-32HNXC0-TS   |
| 19 | CCS-32NX0-MS  | 61 | CCS-32TX0     | 103 | CCS-32HNXC-MS   | 145 | CCS-32HTXC      |
| 20 | CCS-32NX0-S   | 62 | CCS-32TX0-D   | 104 | CCS-32HNXC-S    | 146 | CCS-32HTXC-D    |
| 21 | CCS-32NX0-T   | 63 | CCS-32TX0-DM  | 105 | CCS-32HNXC-T    | 147 | CCS-32HTXC-DM   |
| 22 | CCS-32NX0-TM  | 64 | CCS-32TX0-DMS | 106 | CCS-32HNXC-TM   | 148 | CCS-32HTXC-DMS  |
| 23 | CCS-32NX0-TMS | 65 | CCS-32TX0-DS  | 107 | CCS-32HNXC-TMS  | 149 | CCS-32HTXC-DS   |
| 24 | CCS-32NX0-TS  | 66 | CCS-32TX0-M   | 108 | CCS-32HNXC-TS   | 150 | CCS-32HTXC-M    |
| 25 | CS-32NXC      | 67 | CCS-32TX0-MS  | 109 | CCS-32HNXC0     | 151 | CCS-32HTXC-MS   |
| 26 | CS-32NXC-D    | 68 | CCS-32TX0-S   | 110 | CCS-32HNXC0-D   | 152 | CCS-32HTXC-S    |
| 27 | CS-32NXC-DM   | 69 | CCS-32TX0-T   | 111 | CCS-32HNXC0-DM  | 153 | CCS-32HTXC-T    |
| 28 | CS-32NXC-DMS  | 70 | CCS-32TX0-TM  | 112 | CCS-32HNXC0-DMS | 154 | CCS-32HTXC-TM   |
| 29 | CS-32NXC-DS   | 71 | CCS-32TX0-TMS | 113 | CCS-32HNXC0-DS  | 155 | CCS-32HTXC-TMS  |
| 30 | CS-32NXC-M    | 72 | CCS-32TX0-TS  | 114 | CCS-32HNXC0-M   | 156 | CCS-32HTXC-TS   |
| 31 | CS-32NXC-MS   | 73 | CS-32TXC      | 115 | CCS-32HNXC0-MS  | 157 | CCS-32HTXC0     |
| 32 | CS-32NXC-S    | 74 | CS-32TXC-D    | 116 | CCS-32HNXC0-S   | 158 | CCS-32HTXC0-D   |
| 33 | CS-32NXC-T    | 75 | CS-32TXC-DM   | 117 | CCS-32HNXC0-T   | 159 | CCS-32HTXC0-DM  |
| 34 | CS-32NXC-TM   | 76 | CS-32TXC-DMS  | 118 | CCS-32HNXC0-TM  | 160 | CCS-32HTXC0-DMS |
| 35 | CS-32NXC-TMS  | 77 | CS-32TXC-DS   | 119 | CCS-32HNXC0-TMS | 161 | CCS-32HTXC0-DS  |
| 36 | CS-32NXC-TS   | 78 | CS-32TXC-M    | 120 | CCS-32HNXC0-TS  | 162 | CCS-32HTXC0-M   |
| 37 | CS-32NX0      | 79 | CS-32TXC-MS   | 121 | CS-32HNXC       | 163 | CCS-32HTXC0-MS  |
| 38 | CS-32NX0-D    | 80 | CS-32TXC-S    | 122 | CS-32HNXC-D     | 164 | CCS-32HTXC0-S   |
| 39 | CS-32NX0-DM   | 81 | CS-32TXC-T    | 123 | CS-32HNXC-DM    | 165 | CCS-32HTXC0-T   |
| 40 | CS-32NX0-DMS  | 82 | CS-32TXC-TM   | 124 | CS-32HNXC-DMS   | 166 | CCS-32HTXC0-TM  |
| 41 | CS-32NX0-DS   | 83 | CS-32TXC-TMS  | 125 | CS-32HNXC-DS    | 167 | CCS-32HTXC0-TMS |
| 42 | CS-32NX0-M    | 84 | CS-32TXC-TS   | 126 | CS-32HNXC-M     | 168 | CCS-32HTXC0-TS  |

\* X = 1 (28Vdc), 2 (15Vdc), 3 (12Vdc) and 4 (24Vdc)



**FAILSAFE CCS-32N/CS-32N • CCS-32T/CS-32T PART NUMBER LIST**

|     | <b>PART No.</b> |
|-----|-----------------|
| 169 | CS-32HTXC       |
| 170 | CS-32HTXC-D     |
| 171 | CS-32HTXC-DM    |
| 172 | CS-32HTXC-DMS   |
| 173 | CS-32HTXC-DS    |
| 174 | CS-32HTXC-M     |
| 175 | CS-32HTXC-MS    |
| 176 | CS-32HTXC-S     |
| 177 | CS-32HTXC-T     |
| 178 | CS-32HTXC-TM    |
| 179 | CS-32HTXC-TMS   |
| 180 | CS-32HTXC-TS    |
| 181 | CS-32HTX0       |
| 182 | CS-32HTX0-D     |
| 183 | CS-32HTX0-DM    |
| 184 | CS-32HTX0-DMS   |
| 185 | CS-32HTX0-DS    |
| 186 | CS-32HTX0-M     |
| 187 | CS-32HTX0-MS    |
| 188 | CS-32HTX0-S     |
| 189 | CS-32HTX0-T     |
| 190 | CS-32HTX0-TM    |
| 191 | CS-32HTX0-TMS   |
| 192 | CS-32HTX0-TS    |

\* X = 6 (28Vdc), 7 (15Vdc), 8 (12Vdc) and 9 (24Vdc)

## X-ON Electronics

Largest Supplier of Electrical and Electronic Components

*Click to view similar products for [Coaxial Switches](#) category:*

*Click to view products by [Teledyne](#) manufacturer:*

Other Similar products are found below :

[CR-53S10](#) [R570012030](#) [R570022105](#) [R570123005](#) [R570262100](#) [R570312100](#) [R570323100](#) [R570363010](#) [R570423000](#) [R570432000](#)  
[R570433000](#) [R570442100](#) [R570D33000](#) [R570E52010](#) [R574402410](#) [R585422030](#) [R585423230](#) [R585462200](#) [R599311000](#) [R599906000](#)  
[ARD70224](#) [CCT-38S150-T](#) [R570012000](#) [R570063100](#) [R570143005](#) [R570313000](#) [R570313100](#) [R570323000](#) [R570333040](#) [R570343000](#)  
[R570343040](#) [R570362100](#) [R570423030](#) [R570432010](#) [R570433100](#) [R570443030](#) [R570463100](#) [R570F63010](#) [R573003425](#) [R573302435](#)  
[R573433600](#) [R577042100](#) [R577313000](#) [R577442100](#) [CR-58S160](#) [R570442010](#) [R573482620](#) [R573422420](#) [R574413300](#) [R573413685](#)