

Features

- High Efficiency (Up to 90%)
- Second Generation with Improved Performance
- Active Power Factor Correction (Typical 0.95)
- Constant Current Output
- Lightning Protection
- Waterproof (IP67)
- Dimming Control
- All-Around Protection: OVP, SCP, OLP,OTP
- SELV



Description

The EUC-052SxxxDV(SV) series operate from a 90 ~ 305 Vac input range. They are designed to be highly efficient and highly reliable. Features include over voltage protection, short circuit protection, over load protection, and over temperature protection.

Models

Output Current	Input Voltage Range	Output Voltage Range	Max. Output Power	Typical Efficiency (1)	Power Factor		Model Number (2, 3)
					120Vac	220Vac	
350 mA	90 ~ 305 Vac	75~149Vdc	52 W	90%	0.96	0.95	EUC-052S035DV(SV)
450 mA	90 ~ 305 Vac	58~116Vdc	52 W	89%	0.96	0.95	EUC-052S045DV(SV)
700 mA	90 ~ 305 Vac	38~75 Vdc	52 W	89%	0.96	0.95	EUC-052S070DV(SV)(4)
1050 mA	90 ~ 305 Vac	25~50 Vdc	52 W	88%	0.96	0.95	EUC-052S105DV(SV)(4)
1400 mA	90 ~ 305 Vac	19~37 Vdc	52 W	87%	0.96	0.95	EUC-052S140DV(SV)(4)
2100 mA	90 ~ 305 Vac	13~25 Vdc	52 W	86%	0.96	0.95	EUC-052S210DV(SV)(4)

Notes: (1) Measured at full load and 220 Vac input.

(2) The DV suffix may be changed to SV to omit the dimming function and remove the three wires associated with that function.

(3) A suffix –xxxx may be added to denote variations or modifications to the base product, where x can be any alphanumeric character or blank.

(4) SELV

Input Specifications

Parameter	Min.	Typ.	Max.	Notes
Input Voltage	90 V	-	305 V	
Input Frequency	47 Hz	-	63 Hz	
Leakage Current	-	-	0.75 mA	At 277Vac 60Hz input
Input AC Current	-	-	0.8 A	Measured at full load and 100 Vac input.
	-	-	0.4 A	Measured at full load and 220 Vac input.

Specifications are subject to changes without notice.

Input Specifications (Continued)

Parameter	Min.	Typ.	Max.	Notes
Inrush Current	-	-	60 A	At 220Vac input 25°C Cold Start. Duration=210 μs, 10%Ipk-10%Ipk.
Inrush Current(I ² t)	-	-	0.2 A ² s	
Power Factor	0.90	-	-	At 100Vac-277Vac, 75%load-100%load
THD	-	-	20%	

Output Specifications

Parameter	Min.	Typ.	Max.	Notes
Output Current Tolerance	-5%	-	5%	
No load output voltage				
I _o = 350 mA	-	-	162 V	
I _o = 450 mA	-	-	125 V	
I _o = 700 mA	-	-	82 V	
I _o = 1050 mA	-	-	56 V	
I _o = 1400 mA	-	-	41 V	
I _o = 2100 mA	-	-	30 V	
Output Current Ripple	-	-	50%I _o	Related to V-I Curve of the LED
Output Current Overshoot / Undershoot	-	-	10%I _o	At full load condition.
Line Regulation	-	-	±1%	
Load Regulation	-	-	±3%	
Turn-on Delay Time	-	0.6 s	1.0 s	Measured at 120Vac input.
	-	0.3 s	0.5 s	Measured at 220Vac input.
Temperature coefficient	-	-	0.2%/°C	Case temperature = 0°C ~T _c max

Note: All specifications are typical at 25 °C unless otherwise stated.

Protection Functions

Parameter	Min.	Typ.	Max.	Notes
Short Circuit Protection	No damage shall occur when any output operating in a short circuit condition. The power supply shall be self-recovery when the fault condition is removed.			
Over Temperature Protection	Hiccup mode. When the case temperature is higher than 110°C, the power supply will turn off automatically; when the case temperature is lower than 75°C, the power supply will be auto recovery.			

General Specifications

Parameter	Min.	Typ.	Max.	Notes
Efficiency I _o = 350 mA I _o = 450 mA I _o = 700 mA I _o = 1050 mA I _o = 1400 mA I _o = 2100 mA	87% 86% 86% 85% 85% 84%	89% 88% 88% 87% 86% 85%	- - - - - -	Measured at full load and 120 Vac input.
Efficiency I _o = 350 mA I _o = 450 mA I _o = 700 mA I _o = 1050 mA I _o = 1400 mA I _o = 2100 mA	88% 87% 87% 86% 86% 85%	90% 89% 89% 88% 87% 86%	- - - - - -	Measured at full load and 220 Vac input.
No Load Power Dissipation			6 W	
MTBF	321,000 Hours	-	-	Measured at 120Vac input, 80%Load and 25°C ambient temperature (MIL-HDBK-217F)
Life Time	-	93,300 Hours	-	Measured at 120Vac input, 80%Load and 60°C case temperature ; See life time vs. Tc curve for the details
Case Temperature	-	-	90 °C	
Dimensions Inches (L × W × H) Millimeters (L × W × H)	6.77 × 1.67 × 1.34 172 × 42.4 × 34.0			
Net Weight	-	480 g		

Note: All specifications are typical at 25 °C unless otherwise stated.

Environmental Specifications

Parameter	Min.	Typ.	Max.	Notes
Operating Temperature	-40 °C	-	+70 °C	Humidity: 10% RH to 100% RH See Derating Curve for more details
Storage Temperature	-40 °C	-	+85 °C	Humidity: 5% RH to 100% RH

Safety & EMC Compliance

Safety Category	Standard
CE	EN 61347-1, EN61347-2-13
EMI Standards	Notes
EN 55015	Conducted emission Test & Radiated emission Test
EN 61000-3-2	Harmonic current emissions
EN 61000-3-3	Voltage fluctuations & flicker

Specifications are subject to changes without notice.

Safety & EMC Compliance (Continued)

EMS Standards	Notes
EN 61000-4-2	Electrostatic Discharge (ESD): 8 kV air discharge, 4 kV contact discharge
EN 61000-4-3	Radio-Frequency Electromagnetic Field Susceptibility Test-RS
EN 61000-4-4	Electrical Fast Transient / Burst-EFT: level 3, criteria A
EN 61000-4-5	Surge Immunity Test: AC Power Line: line to line 4 kV, line to earth 6 kV
EN 61000-4-6	Conducted Radio Frequency Disturbances Test-CS
EN 61000-4-8	Power Frequency Magnetic Field Test
EN 61000-4-11	Voltage Dips
EN 61547	Electromagnetic Immunity Requirements Applies To Lighting Equipment

Derating Curve

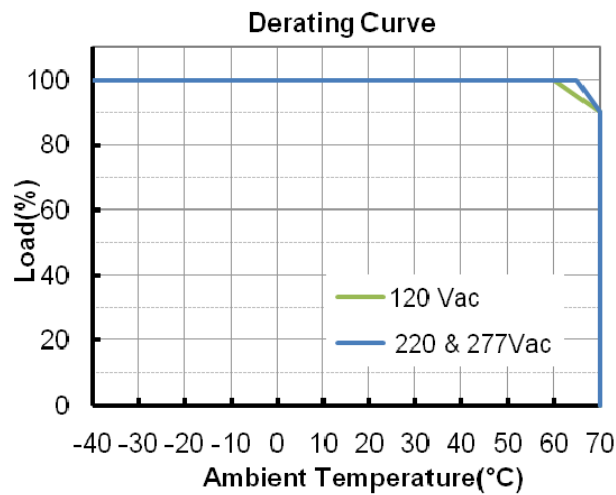

Life Time vs. Case Temperature Curve

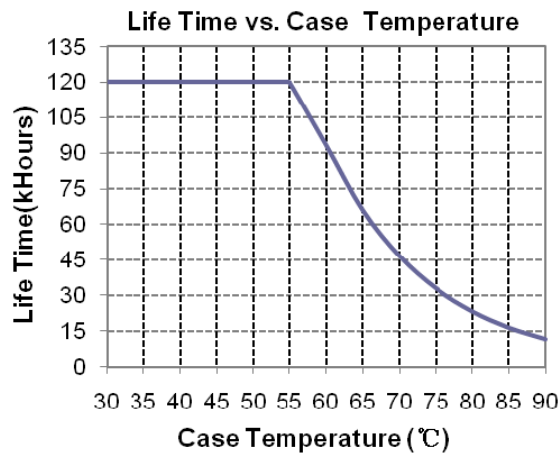

Efficiency vs. Load

EUC-052S035DV(SV)

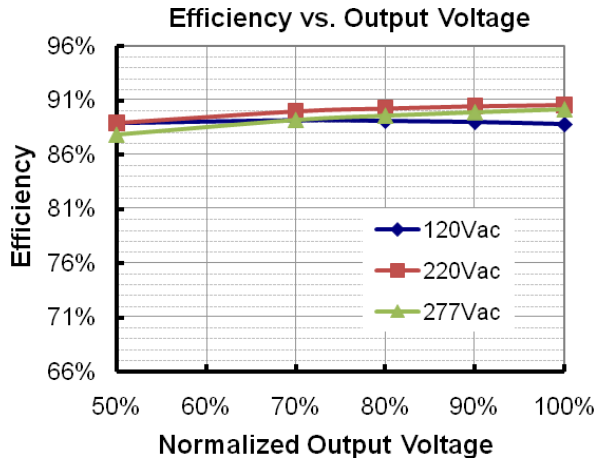

EUC-052S045DV(SV)

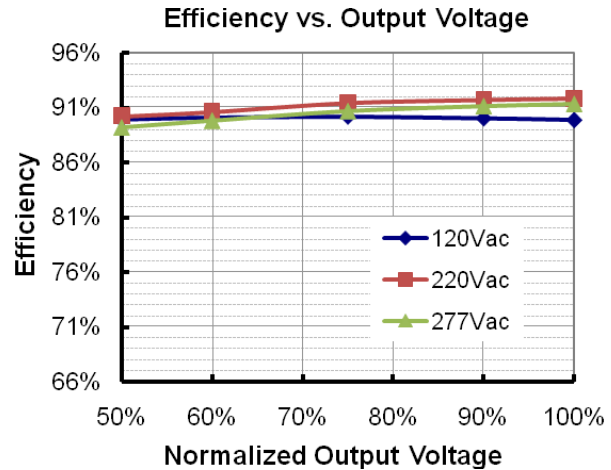

EUC-052S070DV(SV)

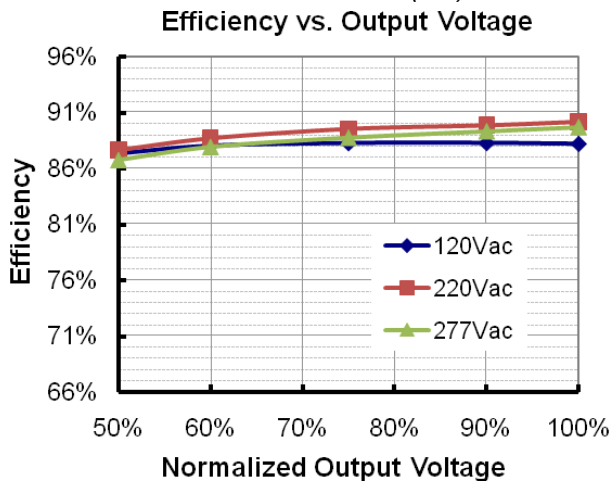

EUC-052S105DV(SV)

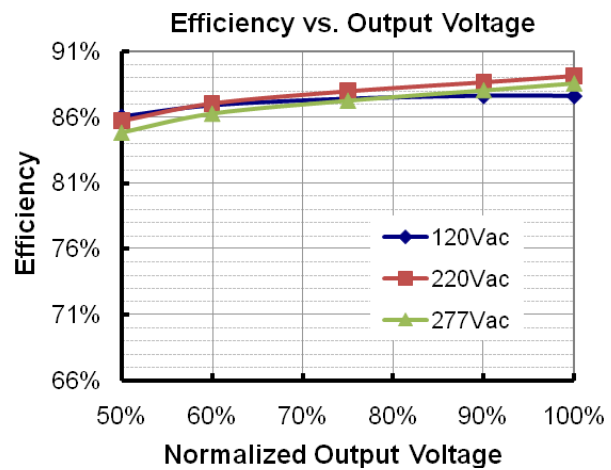

EUC-052S140DV(SV)

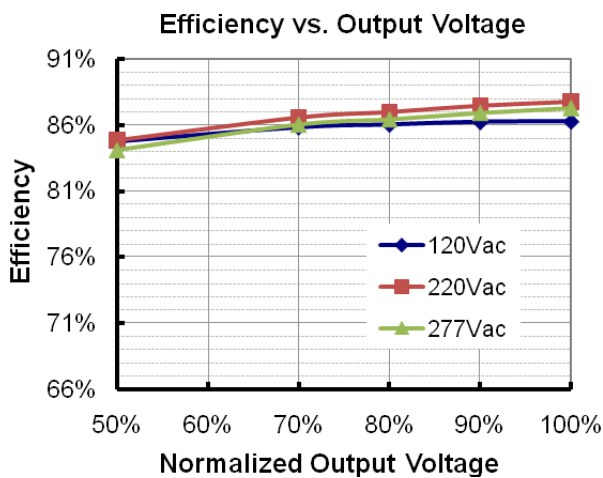

EUC-052S210DV(SV)

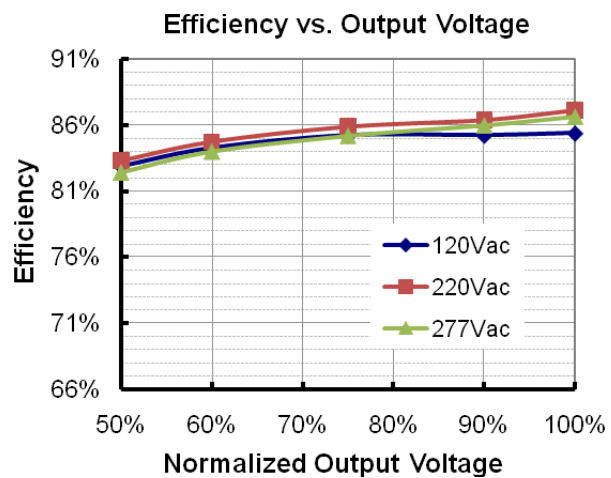

Specifications are subject to changes without notice.

Power Factor Characteristics

EUC-052S035DV(SV)

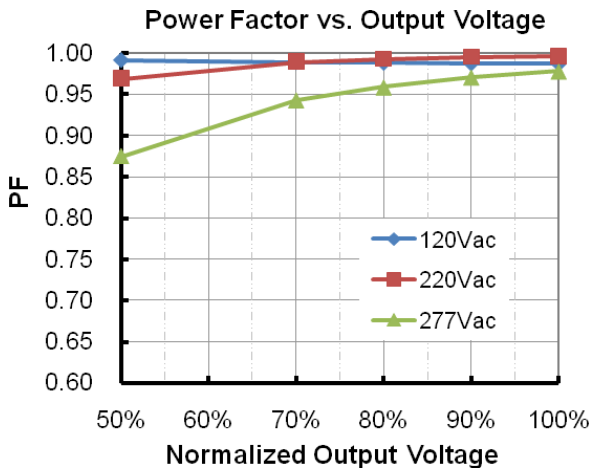

EUC-052S045DV(SV)

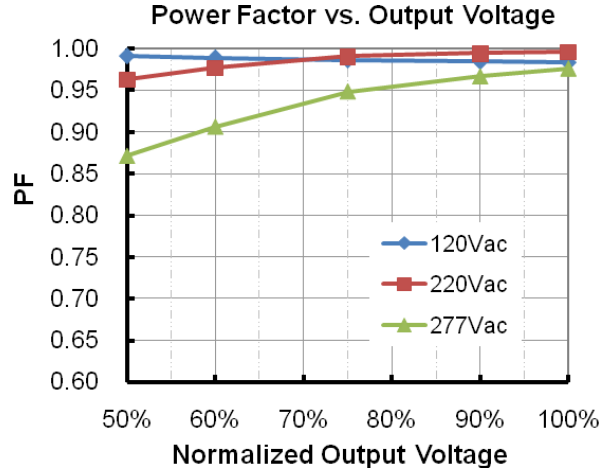

EUC-052S070DV(SV)

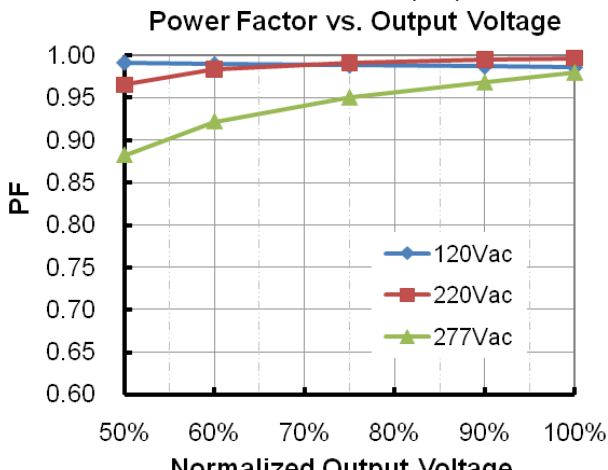

EUC-052S105DV(SV)

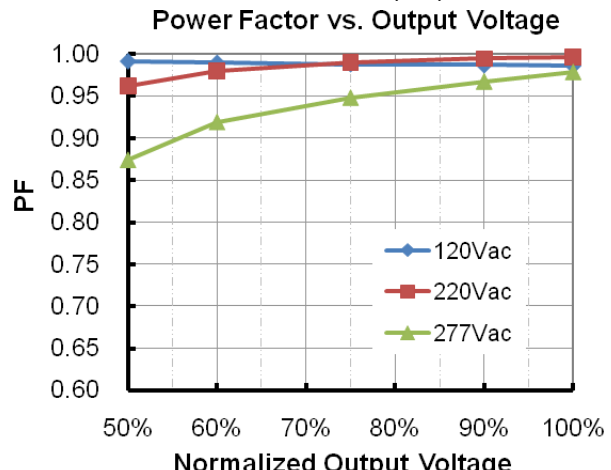

EUC-052S140DV(SV)

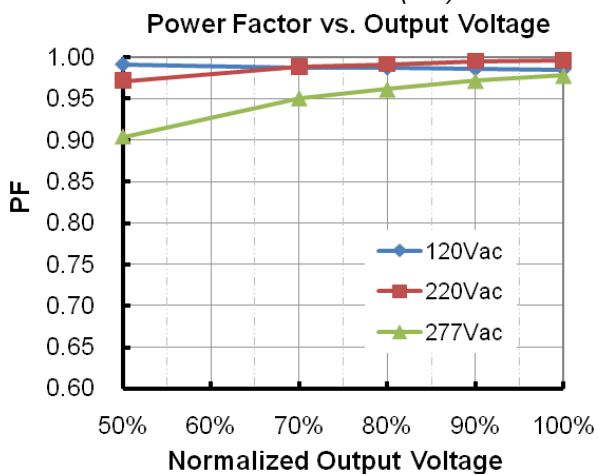

EUC-052S210DV(SV)

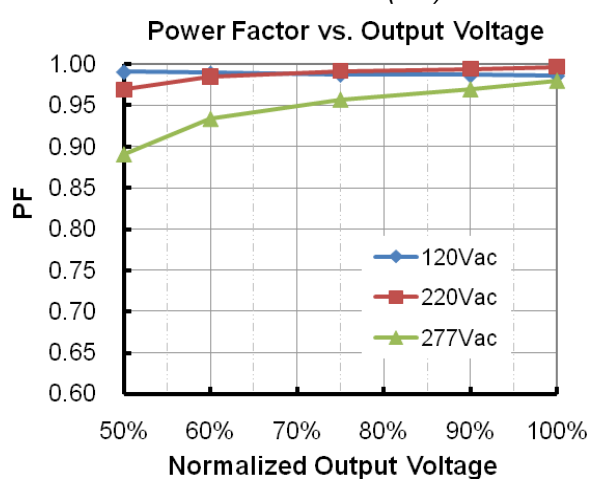

Specifications are subject to changes without notice.

Total Harmonic Distortion Curve (700mA Model)

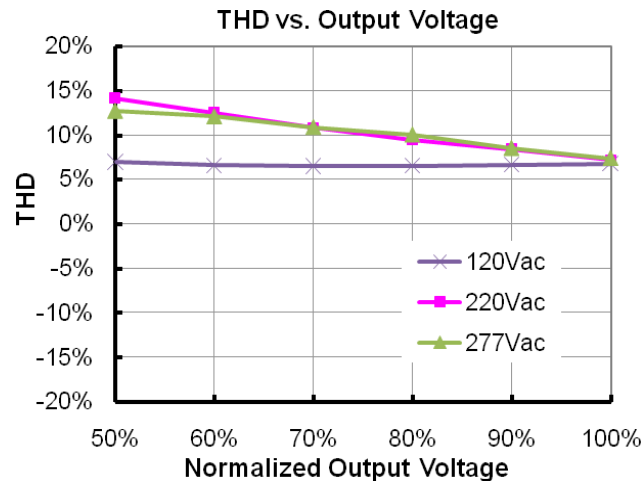

Dimming Control (On secondary side)

Parameter	Min.	Typ.	Max.	Notes
12V Output Voltage	10.8 V	12 V	13.2 V	
12V Output Source Current	0 mA		20 mA	
Absolute Maximum Voltage on the 0~10V Input Pin	0 V	-	15 V	
Source Current on 0~10V Input Pin	0 uA	-	200 uA	

The dimmer control may be operated from either a dimmer or from an input signal of 0 – 10 Vdc. The recommended implementation is provided below.

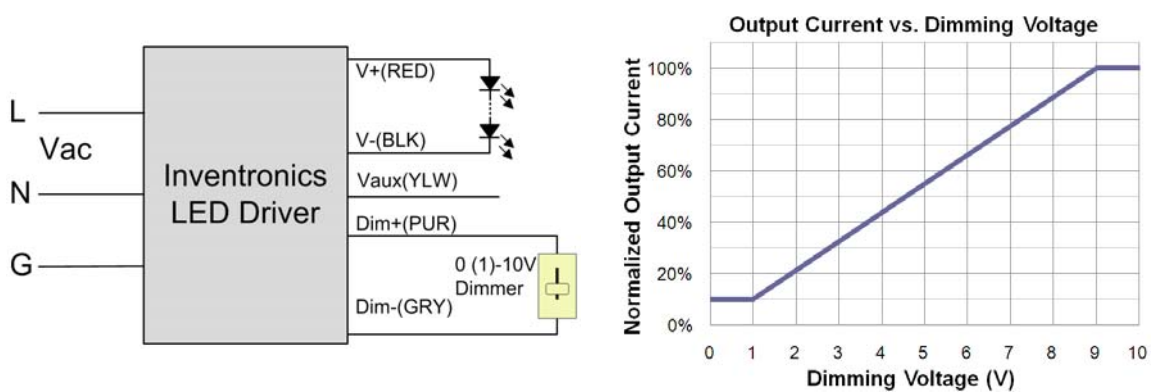

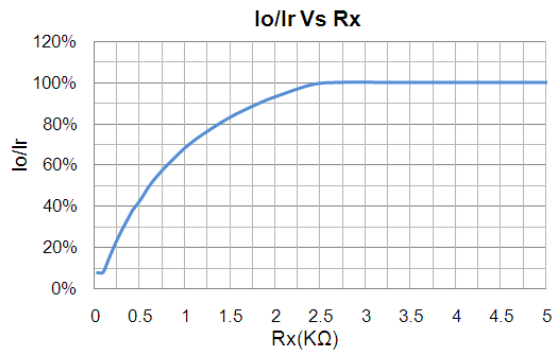
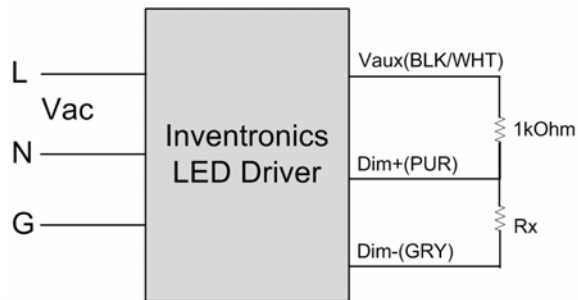

Implementation 2: External Resistor

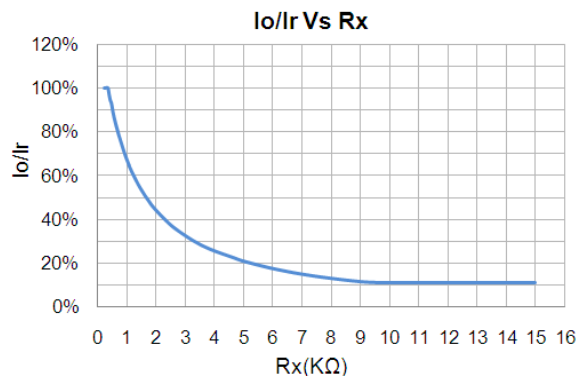
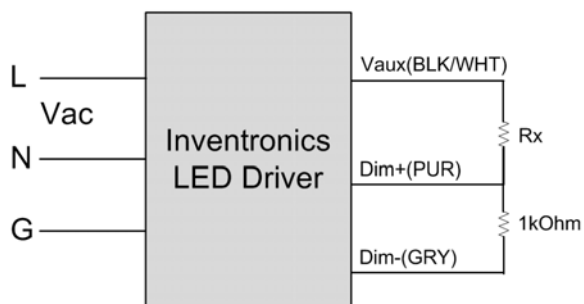

Implementation 3: External Resistor

Notes:

1. Do not connect the GND of dimming to the output; otherwise, the LED driver cannot work normally.
2. If 0-10V dimming is not used, Dim + can be either open or connected to Vaux.

Mechanical Outline

EUC-052SxxxDV

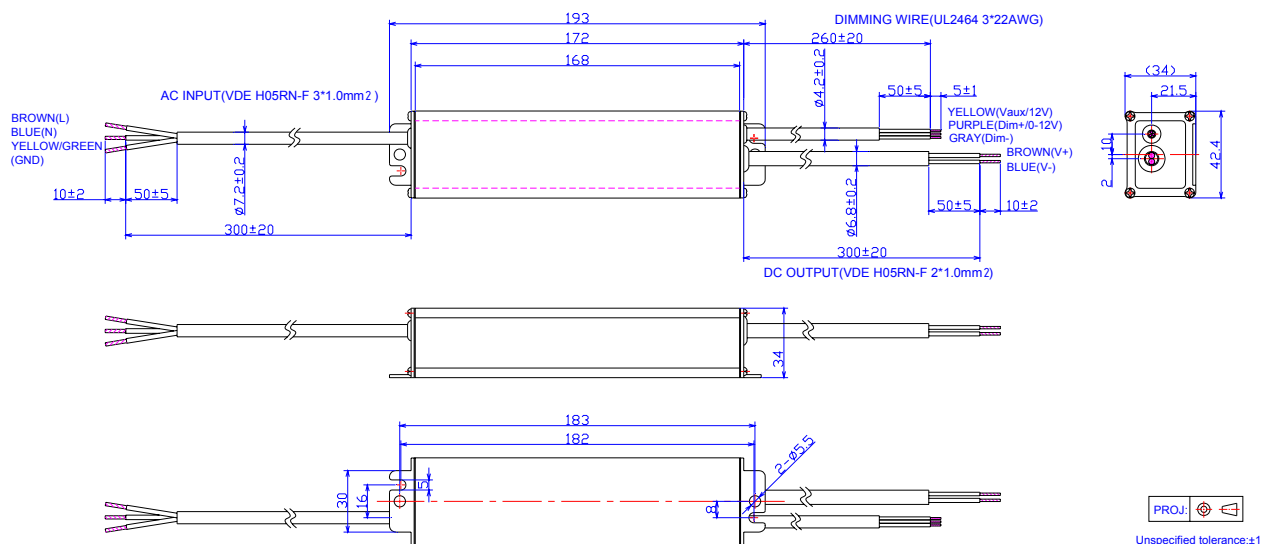

Specifications are subject to changes without notice.

EUC-052SxxxSV

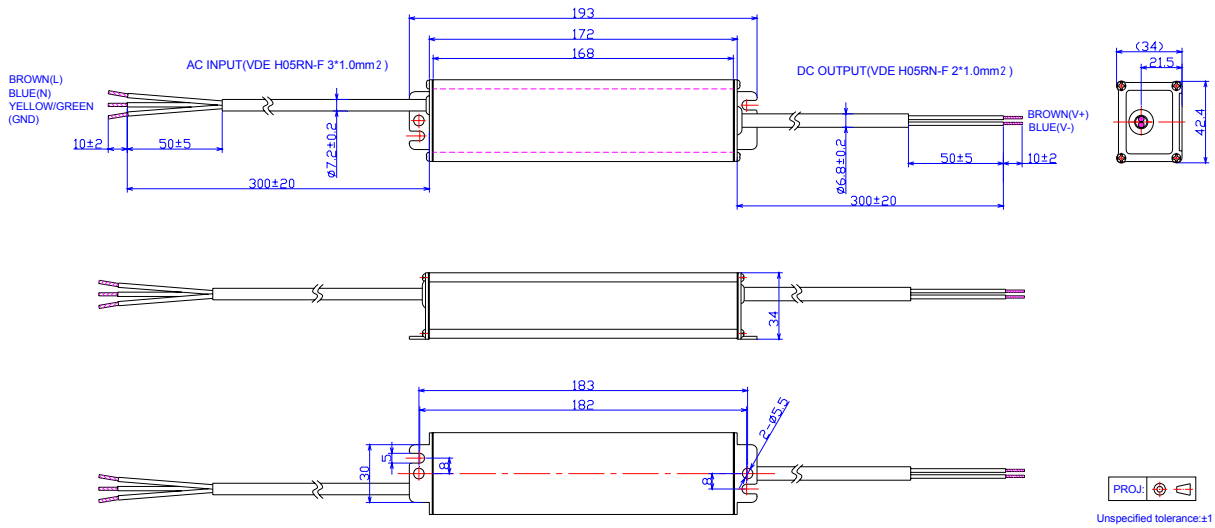

RoHS Compliance

Our products comply with the European Directive 2011/65/EC, calling for the elimination of lead and other hazardous substances from electronic products.

Revision History

Change Date	Rev.	Description of Change		
		Item	From	To
2012-5-4	A	Datasheets Released	/	/
2012-05-25	B	EN 61000-4-5--- line to line 4 kV, line to earth 6 kV	/	Corrected
		Life time	/	50,000 Hours
2012-06-06	C	Notes of life time	/	Updated
		Life time vs. Tc Curve	/	Added
2012-07-02	D	Description of OTP	/	Updated
2012-7-17	E	Max Case Temperature	/	Updated
		Mechanical Outline— wire length 320±20mm	/	Corrected
2012-7-30	F	Min Operating Temperature	-35°C	-40°C
2012-8-16	G	Derating Curve	/	Updated
		THD	/	Updated
		Min PF	/	Added
		Inrush Current(I ² t)	/	Added
		Temperature co-efficient	/	Added
2012-11-9	H	Life time	Min 50,000hrs	Typical 106,000hrs
		Life time Curve	/	Updated
		Mechanical Outline	/	Updated
		CB Certificate	/	Added
		THD Curve	/	Added
		Io/Ir Vs Rx Curve	/	Added
		EFF and PF Curve of other models	/	Added

X-ON Electronics

Largest Supplier of Electrical and Electronic Components

Click to view similar products for [LED Power Supplies](#) category:

Click to view products by [Inventronics](#) manufacturer:

Other Similar products are found below :

[ESS015W-1000-12](#) [EUC-075S105DT](#) [PDA-WIFI](#) [PIFC-K250F](#) [PITB-K222A](#) [ALD-514012PJ134](#) [LB240S24KH](#) [LMH020-SPLC-0000-0000001](#) [79534](#) [79535](#) [EUG-200S210DT](#) [ESS030W-1050-21](#) [ESS030W-0900-32](#) [BPOXL 4-12-035](#) [SLM160W-3.9-40-ZA](#) [ESS010W-0180-42](#) [ESS010W-0350-24](#) [ESS010W-0200-42](#) [PDA080B-1A0G](#) [PDA150B-S1A5G](#) [ZPS-20](#) [SLM140W-1.05-130-ZA](#) [ESS040W-1400-27](#) [ESS015W-0700-18](#) [ESS010E-0250-42](#) [EDC-100S105SV-0007](#) [79278](#) [EUD-150S350DVA](#) [LWA320-C420-ARK-B](#) [50304](#) [HVG-320-36AB](#) [HVG-320-54AB](#) [OT FIT 50/220-240/300 D L](#) [OT FIT 35/220-240/350 D CS L](#) [OT FIT 65/220-240/350 D CS L](#) [ELEMENT 30/220-240/700 S](#) [LC 75W 100-400MA 1-10V LP EXC](#) [LCA 35W 150-700MA ONE4ALL LP PRE](#) [LCA 50W 100-400MA ONE4ALL LP PRE](#) [LCA 50W 350-1050MA ONE4ALL LP PRE](#) [LCA 50W 350-1050MA 2XCH LP PRE](#) [LCI 150/325-1050/300 O4A SL PRE](#) [LCA 75W 100-400MA ONE4ALL LP PRE](#) [LCA 45W 500-1400MA ONE4ALL SC PRE](#) [LC 50W 100-400MA FLEXC LP EXC](#) [LCA 75W 350-1050MA ONE4ALL LP PRE](#) [LC 50W 350-1050MA FLEXC LP EXC](#) [LC 75W 350-1050MA FLEXC LP EXC](#) [LCA 75W 900-1800MA ONE4ALL LP PRE](#) [LCA 100W 250-700MA ONE4ALL LP PRE](#)