

Features

- High Efficiency (Up to 90%)
- Active Power Factor Correction (0.99 Typical)
- Constant Current Output
- Dimming Function
- Lightning Protection
- All-Around Protection: OVP, SCP, OTP
- Waterproof (IP67)
- SELV



Description

The EUC-075SxxxDV(SV) Series operate from a 90 ~ 305 Vac input range. They are designed to be highly efficient and highly reliable. Features include dimming control, over voltage protection, short circuit protection and over temperature protection.

Models

Output Current	Input Voltage Range(1)	Output Voltage Range	Max. Output Power	Typical Efficiency (2)	Power Factor		Model Number (3)
					120Vac	220Vac	
350 mA	90 ~ 305 Vac	107~214Vdc	75 W	90%	0.99	0.96	EUC-075S035DV(SV)
450 mA	90 ~ 305 Vac	83~166 Vdc	75 W	90%	0.99	0.96	EUC-075S045DV(SV)
700 mA	90 ~ 305 Vac	54~108 Vdc	75 W	90%	0.99	0.96	EUC-075S070DV(SV)(4)
1050 mA	90 ~ 305 Vac	36 ~72 Vdc	75 W	89%	0.99	0.96	EUC-075S105DV(SV)(4)
1400 mA	90 ~ 305 Vac	27 ~54 Vdc	75 W	89%	0.99	0.96	EUC-075S140DV(SV)(4)
2100 mA	90 ~ 305 Vac	18 ~36 Vdc	75 W	88%	0.99	0.96	EUC-075S210DV(SV)(4)
2800 mA	90 ~ 305 Vac	13 ~27 Vdc	75 W	88%	0.99	0.96	EUC-075S280DV(SV)(4)
3750 mA	90 ~ 305 Vac	10 ~20 Vdc	75 W	87%	0.99	0.96	EUC-075S375DV(SV)(4)
5000 mA	90 ~ 305 Vac	7 ~15 Vdc	75 W	86%	0.99	0.96	EUC-075S500DV(SV)(4)

- Notes:** (1) Certified input Voltage range 100-240Vac
 (2) Measured at full load and 220 Vac input
 (3) A suffix –xxx may be added to denote variations or modifications to the base product, where x can be any alphanumeric character or blank
 (4) SELV

Input Specifications

Parameter	Min.	Typ.	Max.	Notes
Input Voltage	90 V	-	305 V	
Input Frequency	47 Hz	-	63 Hz	
Leakage Current	-	-	0.75 mA	At 277Vac 60Hz input

Input Specifications (Continued)

Parameter	Min.	Typ.	Max.	Notes
Input AC Current	-	-	0.9 A	Measured at full load and 100 Vac input.
	-	-	0.42 A	Measured at full load and 220 Vac input.
Inrush Current	-	-	60 A	At 220Vac input, 25 °C cold start, duration=1 ms, 10%lpk-10%lpk.
Inrush Current(I ² t)	-	-	1 A ² s	
Power Factor	0.9	-	-	At 100Vac-277Vac,100%load
THD	-	-	20%	

Output Specifications

Parameter	Min.	Typ.	Max.	Notes
Output Current Range	-5%	-	5%	
Ripple and Noise (pk-pk)	-	-	5% V _O	Measured by 20 MHz bandwidth oscilloscope and the output paralleled a 0.1 uF ceramic capacitor and a 10 uF electrolytic capacitor. V _O is the maximum output voltage.
No Load Output Voltage				
I _o = 350 mA	-	224 V	-	
I _o = 450 mA	-	172 V	-	
I _o = 700 mA	-	112 V	-	
I _o = 1050 mA	-	76 V	-	
I _o = 1400 mA	-	58 V	-	
I _o = 2100 mA	-	40 V	-	
I _o = 2800 mA	-	34 V	-	
I _o = 3750 mA	-	25 V	-	
I _o = 5000 mA	-	19 V	-	
Line Regulation	-	-	±1%	
Load Regulation	-	-	±3%	
Turn-on Delay Time	-	0.8 s	1.2 s	Measured at 120Vac input.
	-	0.4 s	0.6 s	Measured at 220Vac input.
Temperature coefficient	-	-	0.06%/°C	Case temperature = 0°C ~T _c max

Note: All specifications are typical at 25 °C unless otherwise stated.

Protection Functions

Parameter	Min.	Typ.	Max.	Notes
Over Temperature Protection-T _c	-	100 °C	-	Latch mode. The power supply shall return to normal operation only after the power is turn-on again.
Short Circuit Protection	No damage shall occur when any output operating in a short circuit condition. The power supply shall be self-recovery when the fault condition is removed.			

General Specifications

Parameter	Min.	Typ.	Max.	Notes
Efficiency Io = 350 mA Io = 450 mA Io = 700 mA Io = 1050 mA Io = 1400 mA Io = 2100 mA Io = 2800 mA Io = 3750 mA Io = 5000 mA	86% 86% 86% 85% 85% 84% 84% 83% 82%	88% 88% 88% 87% 87% 86% 86% 85% 84%	- - - - - - - - -	Measured at full load, 120Vac input, 25°C ambient temperature, after the unit is thermally stabilized. It will be lower about 2%, if measured immediately after startup.
Efficiency Io = 350 mA Io = 450 mA Io = 700 mA Io = 1050 mA Io = 1400 mA Io = 2100 mA Io = 2800 mA Io = 3750 mA Io = 5000 mA	88% 88% 88% 87% 87% 86% 86% 85% 84%	90% 90% 90% 89% 89% 88% 88% 87% 86%	- - - - - - - - -	Measured at full load, 220Vac input, 25°C ambient temperature, after the unit is thermally stabilized. It will be lower about 2%, if measured immediately after startup.
MTBF	-	320,000 hours	-	Measured at 120Vac input, 80%Load and 25°C ambient temperature (MIL-HDBK-217F)
Life Time	-	107,000 hours	-	Measured at 120Vac input, 80%Load; Case temperature=60°C @ Tc point. See life time vs. Tc curve for the details
Case Temperature	-	-	90°C	
Dimensions Inches (L x W x H) Millimeters (L x W x H)	5.91 x 2.66 x 1.44 150 x 67.5 x 36.5			
Net Weight	-	750 g	-	

Note: All specifications are typical at 25 °C unless otherwise stated.

Environmental Specifications

Parameter	Min.	Typ.	Max.	Notes
Operating Temperature	-40 °C	-	+70 °C	Humidity: 10% RH to 100% RH See Derating Curve for more details
Storage Temperature	-40 °C	-	+85 °C	Humidity: 5% RH to 100% RH

Safety & EMC Compliance

Safety Category	Standard
CE	EN61347-1, EN61347-2-13
EMI Standards	Notes
EN 55015	Conducted emission Test & Radiated emission Test
EN 61000-3-2	Harmonic current emissions
EN 61000-3-3	Voltage fluctuations & flicker

Safety & EMC Compliance (Continued)

EMS Standards	Notes
EN 61000-4-2	Electrostatic Discharge (ESD): 8 kV air discharge, 4 kV contact discharge
EN 61000-4-3	Radio-Frequency Electromagnetic Field Susceptibility Test-RS
EN 61000-4-4	Electrical Fast Transient / Burst-EFT
EN 61000-4-5	Surge Immunity Test: AC Power Line: line to line 4 kV, line to earth 6 kV
EN 61000-4-6	Conducted Radio Frequency Disturbances Test-CS
EN 61000-4-8	Power Frequency Magnetic Field Test
EN 61000-4-11	Voltage Dips
EN 61547	Electromagnetic Immunity Requirements Applies to Lighting Equipment
ENERGY STAR Standards	Notes
ANSI/IEEE C62.41-1991	Transient Protection, power supply shall comply with Class A operation. The line transient shall consist of seven strikes of a 100 kHz ring wave, 2.5 kV level, for both common mode and differential mode.

Derating Curve

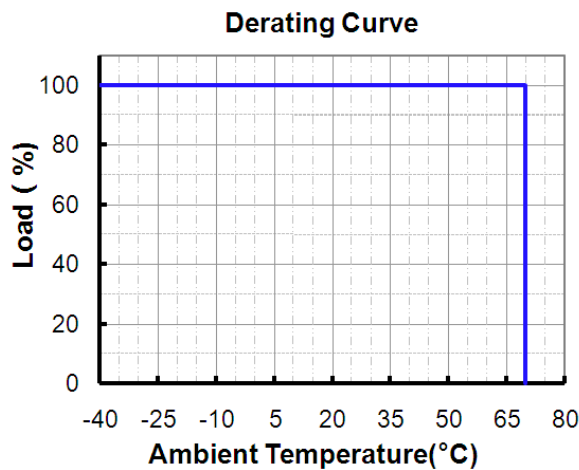

Life Time vs. Case Temperature Curve

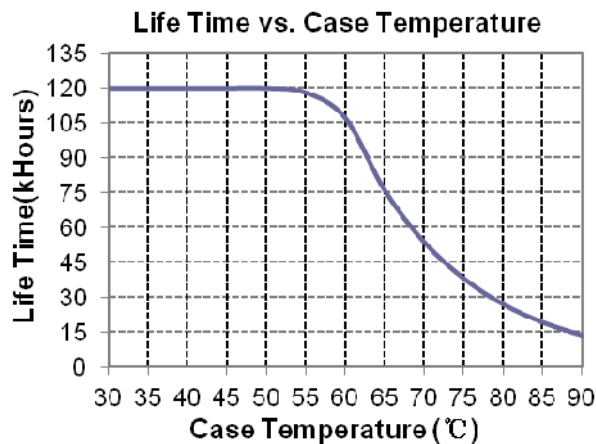

Efficiency vs Load

EUC-075S035DV(SV)

Efficiency vs. Output Voltage

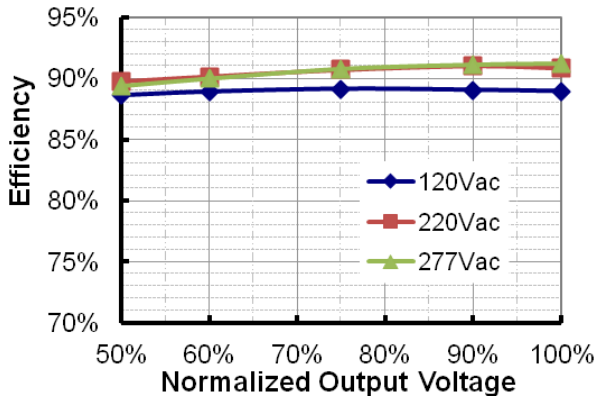

EUC-075S045DV(SV)

Efficiency vs. Output Voltage

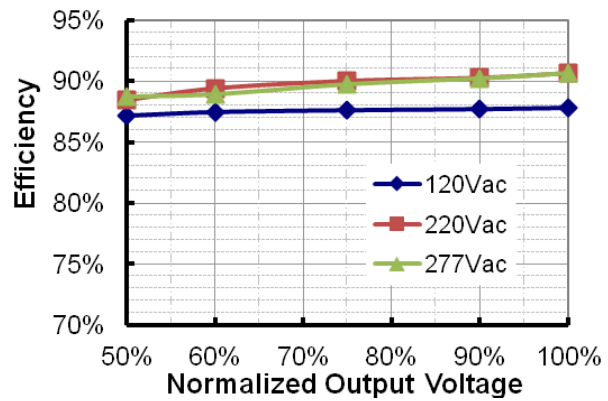

EUC-075S070DV(SV)

Efficiency vs. Output Voltage

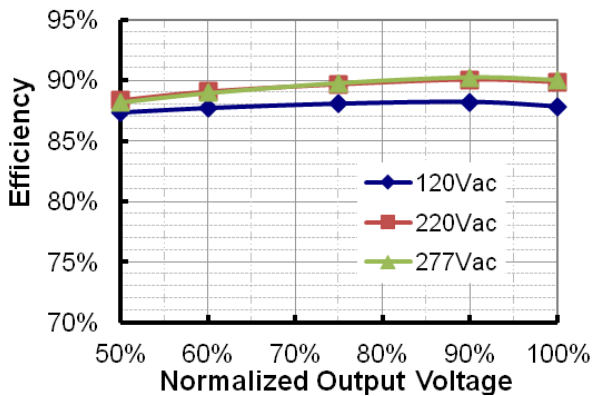

EUC-075S105DV(SV)

Efficiency vs. Output Voltage

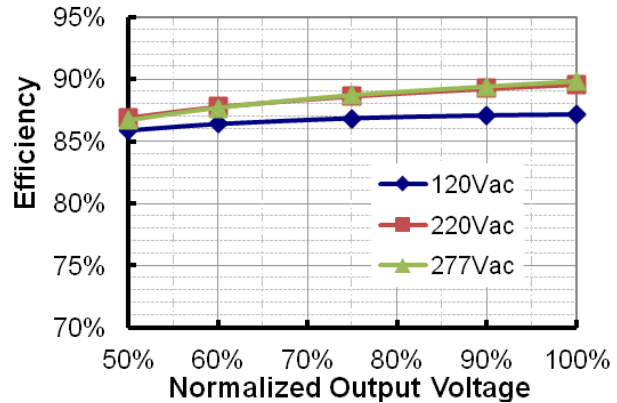

EUC-075S140DV(SV)

Efficiency vs. Output Voltage

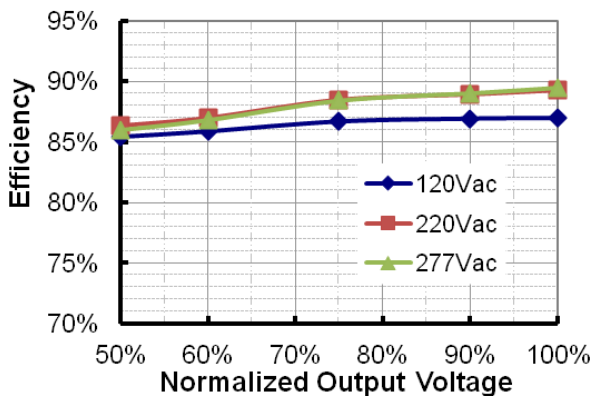

EUC-075S210DV(SV)

Efficiency vs. Output Voltage

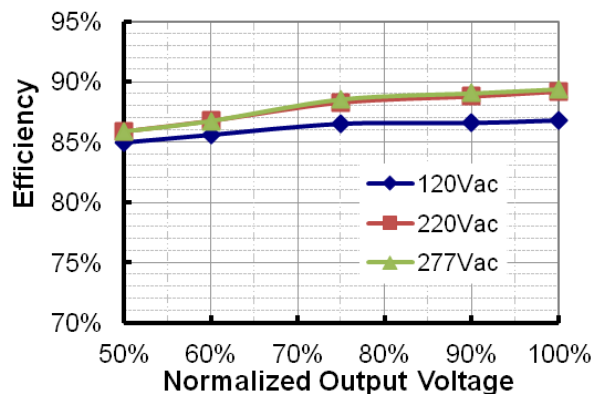

EUC-075S280DV(SV)

Efficiency vs. Output Voltage

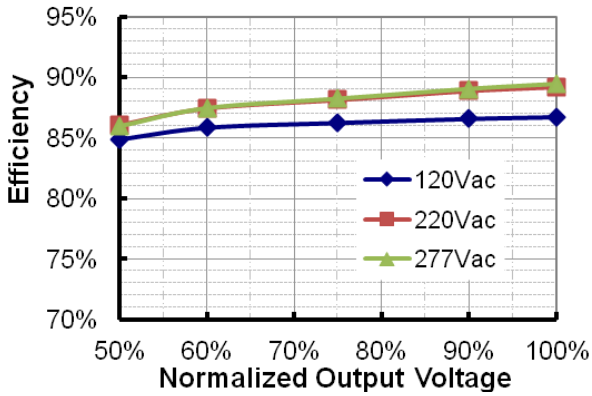

EUC-075S375DV(SV)

Efficiency vs. Output Voltage

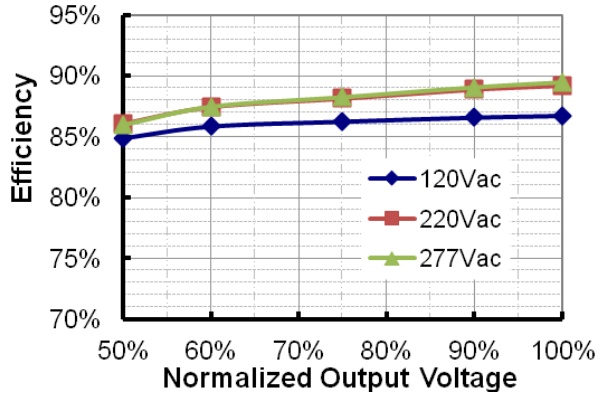

EUC-075S500DV(SV)

Efficiency vs. Output Voltage

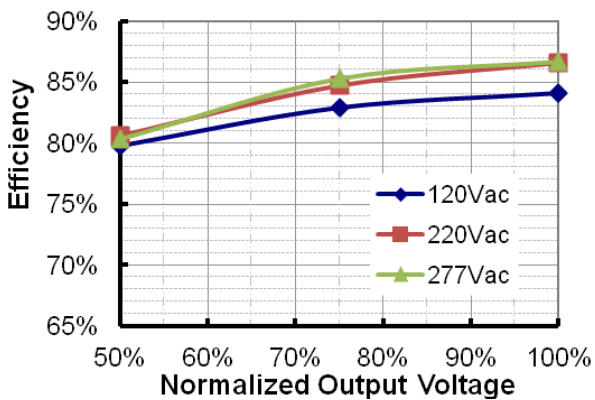

Power Factor Characteristics

PF vs. Output Voltage

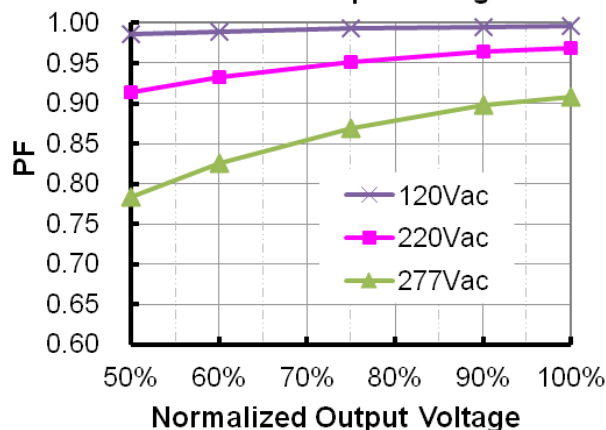

Total Harmonic Distortion

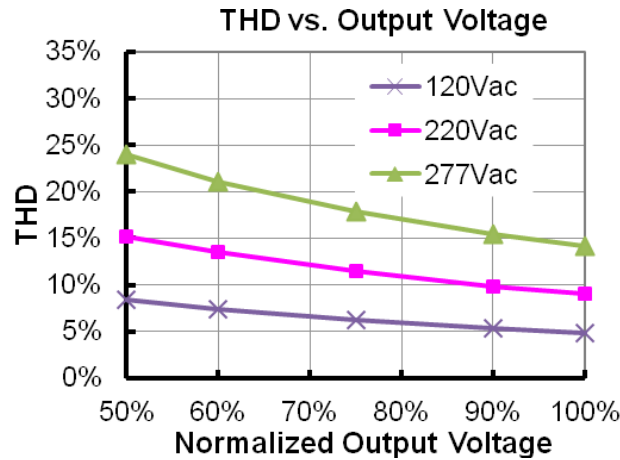

Dimming Control (On secondary side)

The function has two versions. One is with internal pull-up resistor, the output is full load when the dimming leads are floated. Another is with internal pull-down resistor, the output is 10% full load when the dimming leads are floated.

1. With pull-up resistor (Default, without suffix):

Parameter	Min.	Typ.	Max.	Notes
10V output voltage	9.8 V	10 V	10.2 V	
10V output source current	0 mA	-	10 mA	
Absolute maximum voltage on the 1~10V input pin	-2 V	-	12 V	
Source current on 1~10V input pin	0 mA	-	0.5 mA	
Value of Rin (the resistor inside the LED driver which locate between the 1-10V input and 10V output pin)	19.8 K	20 K	20.2 K	

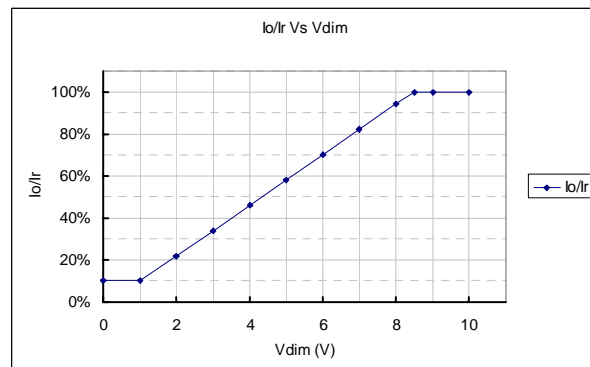
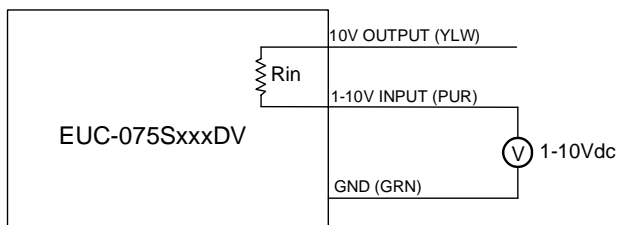

Implementation 1: DC input

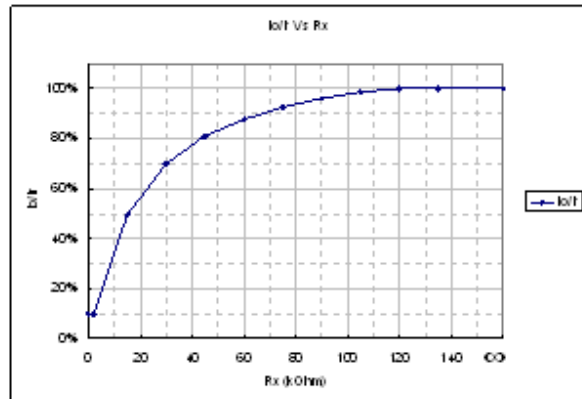
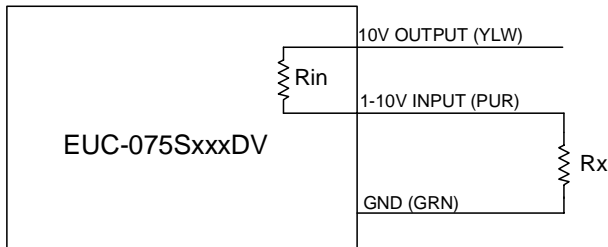

Implementation 2: External resistor

Notes:

1. If the dimming function is not used, please let the dimming leads floated.
2. I_o is actual output current and I_r is rated current without dimming control.
3. For the driver to operate properly, the load voltage must be maintained above the minimum voltage threshold (approx. 50% of the max. output voltage for any given model).
4. If the output voltage is maintained above 50% of the maximum output voltage, the dimming control may be operated over the entire 1-10V range with output current varying from 100% down to practically 10%.
5. The dimming signal is allowed to be less than 1V, however, when it for 0-1V, the output current can maintain about 10% I_r . When it for 8.5-10V, the output current can maintain about 100% I_r .
6. Do not connect the GND of dimming to the output; otherwise, the LED driver can not work normally.

2. With pull-down resistor: (The model number has a suffix -0040)

Parameter	Min.	Typ.	Max.	Notes
10V output voltage	9.8 V	10 V	10.2 V	
10V output source current	0 mA	-	10 mA	
Absolute maximum voltage on the 1~10V input pin	-2 V	-	12 V	
Sink current on 1~10V input pin	0 mA	-	1 mA	
Value of Rin (the resistor inside the LED driver which locate between the 1-10V input and GND)	9.9 K	10 K	10.1 K	

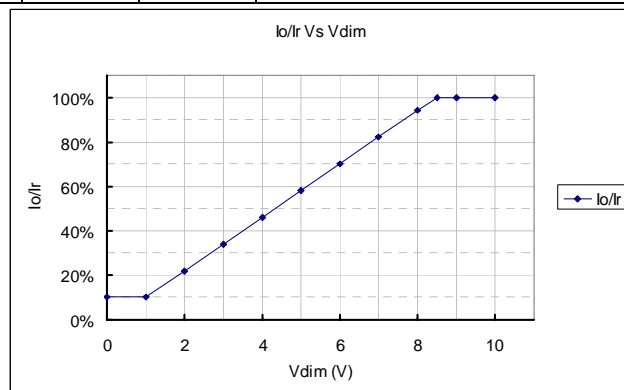
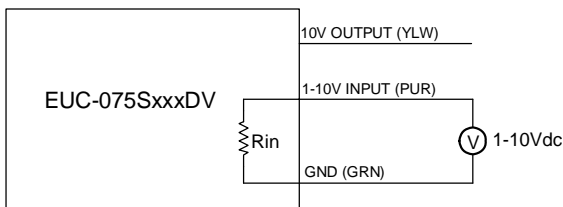

Implementation 1: DC input

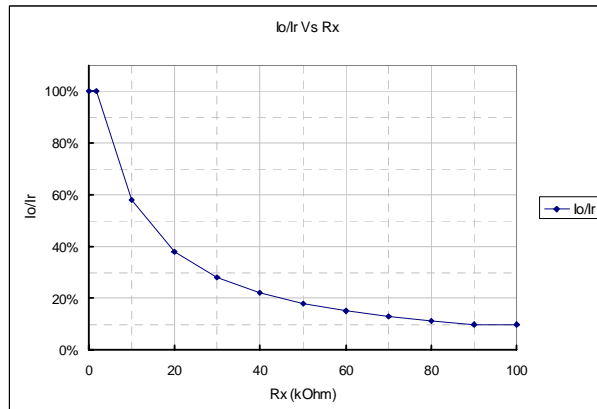
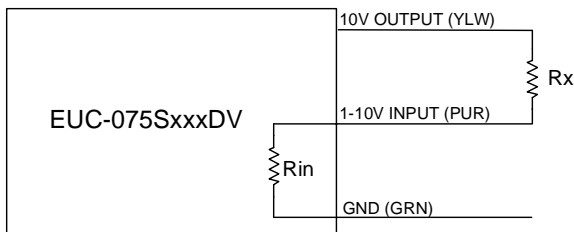

Implementation 2: External resistor

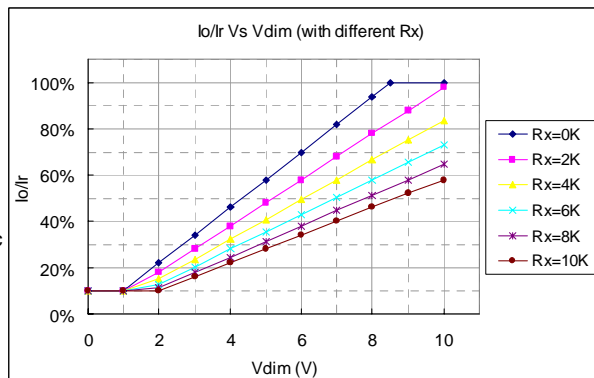
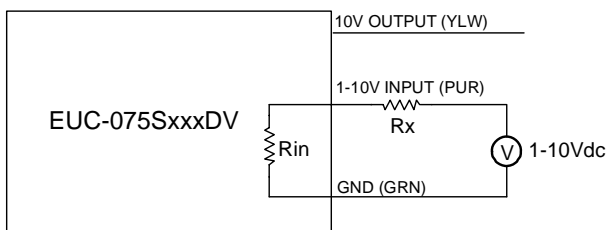

Implementation 3: External resistor and 1-10V DC Input

Notes:

1. If the dimming function is not used, please short 10V output pin (yellow) and 1-10 input pin (purple).
2. I_o is actual output current and I_r is rated current without dimming control.
3. For the driver to operate properly, the load voltage must be maintained above the minimum voltage threshold (approx. 50% of the max. output voltage for any given model).
4. If the output voltage is maintained above 50% of the maximum output voltage, the dimming control may be operated over the entire 1-10V range with output current varying from 100% down to practically 10%.
5. The dimming signal is allowed to be less than 1V, however, when it for 0-1V, the output current can maintain about 10% I_r . When it for 8.5-10V, the output current can maintain about 100% I_r .
6. Do not connect the GND of dimming to the output; otherwise, the LED driver can not work normally.

Mechanical Outline

EUC-075SxxxDV

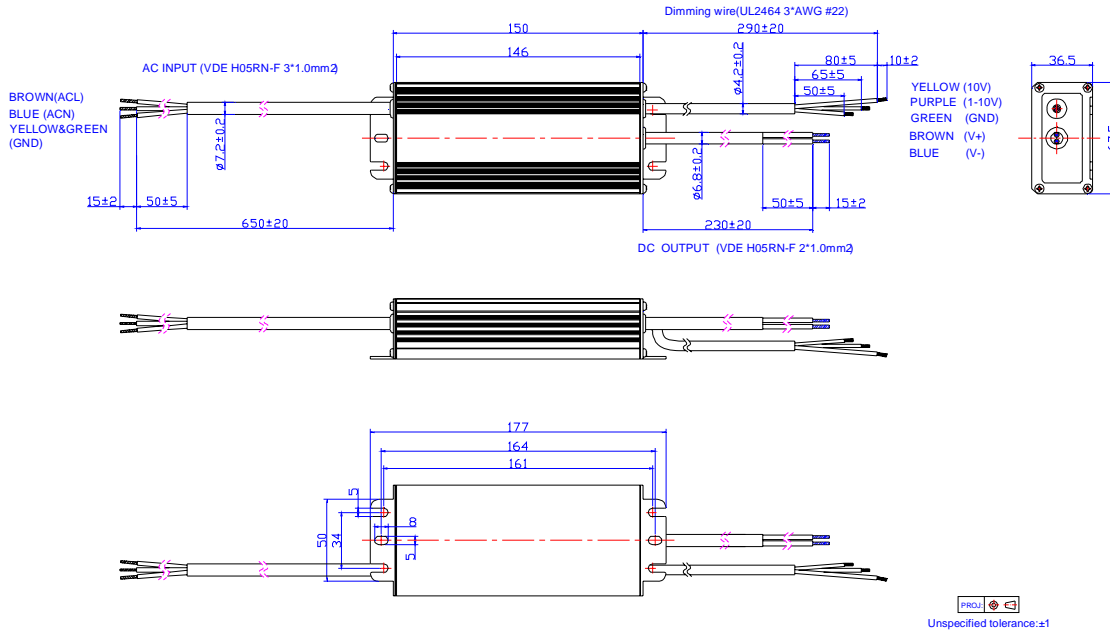

EUC-075SxxxSV

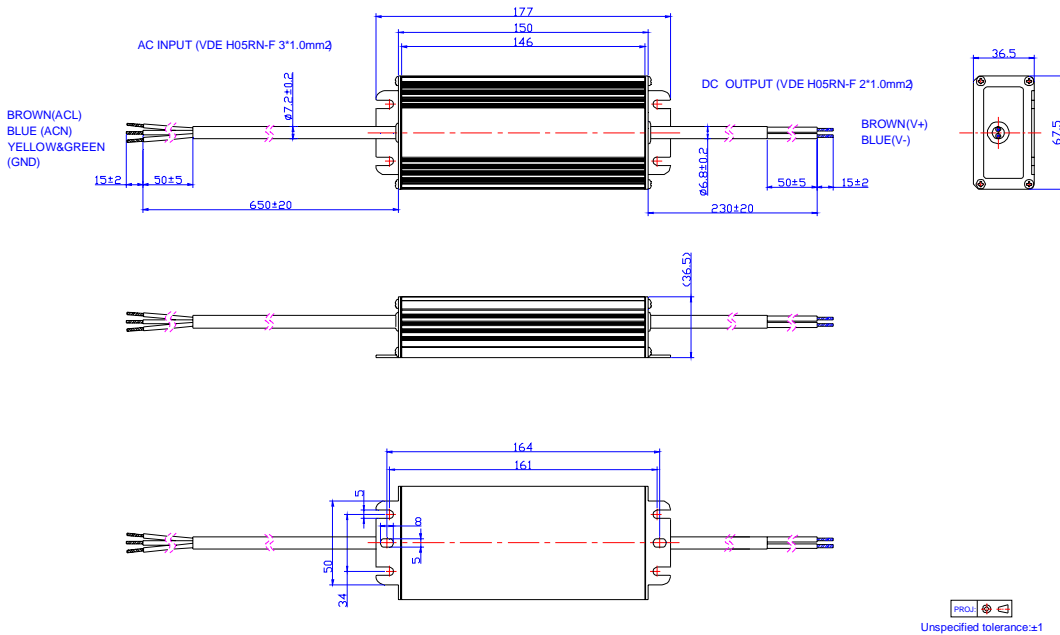

RoHS Compliance

Our products comply with the European Directive 2011/65/EC, calling for the elimination of lead and other hazardous substances from electronic products.

Revision History

Change Date	Rev.	Description of Change		
		Item	From	To
2010-03-03	A	Add notes of UL1310 Class 2 for all models. (3) (4) (5)		
		Change efficiency for all models		
		Change MTBF	498,000 hours	450,000 hours
		Add Leakage Current in Input Specifications	/	/
		Add Derating Curve	/	/
		Modify the tin-plated wire length tolerance in Mechanical Outline	±0.5	±2
		Add one note in Dimming Control	/	7. Do not connect the GND of dimming to the output; otherwise, the LED driver can not work normally.
2010-05-25	B	Add one item in the notes of Ripple and Noise (pk-pk)	/	Vo is the maximum output voltage.
		Delete Output Overshoot / Undershoot	Max. 10%	/
2010-05-31	C	Add star rank for recommended models	/	☆: Popular model.
		Standardize the tolerance in Mechanical Outline	/	/
2010-07-30	D	Add Energy Star Standard	/	Comply With ANSI/IEEE C62.41, Class A Operation
2010-08-10	F	Change Turn-on Delay Time 120Vac input	Typ. 0.5S Max. 0.8S	Typ. 0.8S Max. 1.2S
2010-10-22	G	Update the part of dimming control	/	/
2010-11-12	H	Change efficiency of 5000 mA 110 Vac 220 Vac	Min. 84%, Typ. 86%, 86%, 88%	Min. 82%, Typ. 84%, 84%, 86%
		Add another dimming version with pull-down resistor	/	/
2011-01-14	I	Change popular models	/	/
2012-06-10	J	Life time curve	/	Added
		EN61000-4-5	line to line 2 kV, line to earth 4 kV	line to line 4 kV, line to earth 6 kV
		Efficiency of some models	/	1% or 2% lower
2012-7-5	k	Inrush Current	50 A	60 A
2012-7-17	L	Max Case Temperature	/	Updated
2012-10-10	M	Min PF, Max THD	/	Added
		Temperature coefficient	/	Added
		MTBF, Life time Typical Value	/	Added
		Life Time Curve	/	Updated
		Operating Temperature	-35 °C	-40 °C
		Derating Curve	/	Updated

2013-05-23	N	Product photo	/	Updated
		Leakage current	1mA	0.75mA
		No load voltage- Typical	/	Added
		OVP	/	Deleted
		Efficiency of 5000mA Model	/	1%lower
		Typical value of OTP	110°C	100°C
		Efficiency curve	/	Added
		PF curve	/	Added
		THD curve	/	Added
		Dimming control- With pull-up resistor dimming curve	/	Updated
		Mechanical outline	/	Updated

X-ON Electronics

Largest Supplier of Electrical and Electronic Components

Click to view similar products for [LED Power Supplies](#) category:

Click to view products by [Inventronics](#) manufacturer:

Other Similar products are found below :

[ESS015W-1000-12](#) [EUC-075S105DT](#) [PDA-WIFI](#) [PIFC-K250F](#) [PITB-K222A](#) [ALD-514012PJ134](#) [LB240S24KH](#) [LMH020-SPLC-0000-0000001](#) [79534](#) [79535](#) [EUG-200S210DT](#) [ESS030W-1050-21](#) [ESS030W-0900-32](#) [BPOXL 4-12-035](#) [SLM160W-3.9-40-ZA](#) [ESS010W-0180-42](#) [ESS010W-0350-24](#) [ESS010W-0200-42](#) [PDA080B-1A0G](#) [PDA150B-S1A5G](#) [ZPS-20](#) [SLM140W-1.05-130-ZA](#) [ESS040W-1400-27](#) [ESS015W-0700-18](#) [ESS010E-0250-42](#) [EDC-100S105SV-0007](#) [79278](#) [EUD-150S350DVA](#) [LWA320-C420-ARK-B](#) [50304](#) [HVG-320-36AB](#) [HVG-320-54AB](#) [OT FIT 50/220-240/300 D L](#) [OT FIT 35/220-240/350 D CS L](#) [OT FIT 65/220-240/350 D CS L](#) [ELEMENT 30/220-240/700 S](#) [LC 75W 100-400MA 1-10V LP EXC](#) [LCA 35W 150-700MA ONE4ALL LP PRE](#) [LCA 50W 100-400MA ONE4ALL LP PRE](#) [LCA 50W 350-1050MA ONE4ALL LP PRE](#) [LCA 50W 350-1050MA 2XCH LP PRE](#) [LCI 150/325-1050/300 O4A SL PRE](#) [LCA 75W 100-400MA ONE4ALL LP PRE](#) [LCA 45W 500-1400MA ONE4ALL SC PRE](#) [LC 50W 100-400MA FLEXC LP EXC](#) [LCA 75W 350-1050MA ONE4ALL LP PRE](#) [LC 50W 350-1050MA FLEXC LP EXC](#) [LC 75W 350-1050MA FLEXC LP EXC](#) [LCA 75W 900-1800MA ONE4ALL LP PRE](#) [LCA 100W 250-700MA ONE4ALL LP PRE](#)