

FEATURES

- **Low Cost**
- **Thick Film Technology**
- **High Density Packaging**
 - Up to 30% less space per resistor than 0603 chip resistors
 - Up to 75% less space per resistor than 0805 chip resistors
- **Low Profile; can be used in PCMCIA cards**
- **Leadless Surface Mount Construction**
- **Concave or Convex Terminations**
- **Solder Coated Nickel Barrier Pads**
- **Isolated and Bussed Circuits**
- **Resistor Arrays Require Fewer Placements Than Discrete Components**
- **Tape and Reel Packaging**
- **RoHS Compliant in Accordance with EU Directive 2005/95/EC**
 - Lead-Free Termination Finish
 - Exemption 5 for Pb in glass material and resistor elements

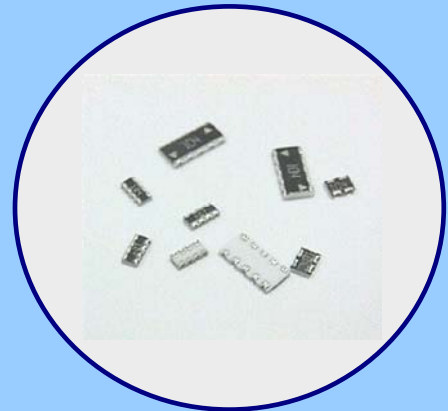

ORDERING INFORMATION

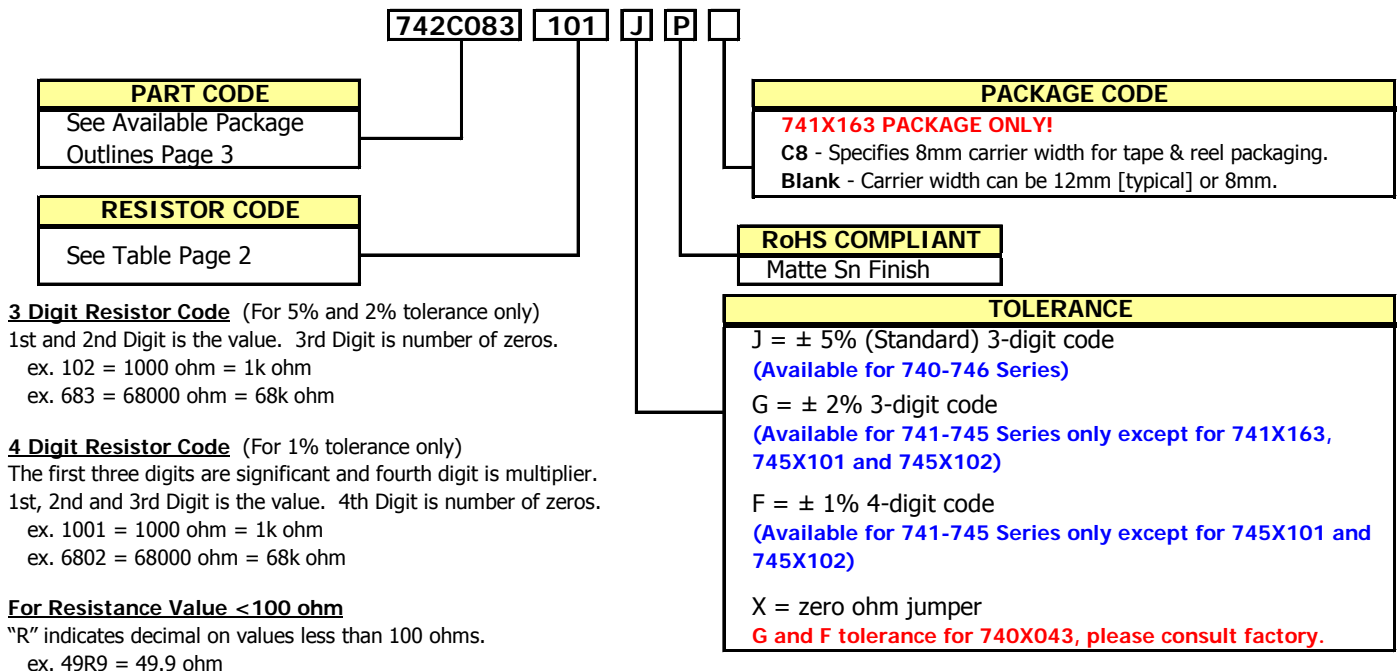

Part Number Examples

| Value\Tolerance | 3-Digit Code | | 4-Digit Code |
|-----------------|---------------|---------------|---------------|
| | J (±5%) | G (±2%) | F (±1%) |
| 10 Ohm | 742C083100JP | 742C083100GP | 742C08310R0FP |
| 49.9 Ohm | Not Available | Not Available | 742C08349R9FP |
| 120 Ohm | 742C083121JP | 742C083121GP | 742C0831200FP |
| 1K Ohm | 742C083102JP | 742C083102GP | 742C0831001FP |
| 68 Kohm | 742C083683JP | 742C083683GP | 742C0836802FP |

**Not all performance combinations and resistor values may be available.
Contact your local CTS Representative or CTS Customer Service for availability.**

ORDERING INFORMATION

AVAILABLE RESISTOR VALUES & EIA CODES

| Ohms | Code | Ohms | Code | Ohms | Code | Ohms | Code | Ohms | Code | Ohms | Code |
|------|------|------|------|------|------|-------|------|-------|------|------|------|
| 0 | 000X | 68 | 680 | 510 | 511 | 3.9K | 392 | 30.0K | 303 | 220K | 224 |
| 10 | 100 | 75 | 750 | 560 | 561 | 4.3K | 432 | 33.0K | 333 | 240K | 244 |
| 11 | 110 | 82 | 820 | 620 | 621 | 4.7K | 472 | 36.0K | 363 | 270K | 274 |
| 12 | 120 | 91 | 910 | 680 | 681 | 5.1K | 512 | 39.0K | 393 | 300K | 304 |
| 13 | 130 | 100 | 101 | 750 | 751 | 5.6K | 562 | 43.0K | 433 | 330K | 334 |
| 15 | 150 | 110 | 111 | 820 | 821 | 6.2K | 622 | 47.0K | 473 | 360K | 364 |
| 16 | 160 | 120 | 121 | 910 | 911 | 6.8K | 682 | 51.0K | 513 | 390K | 394 |
| 18 | 180 | 130 | 131 | 1.0K | 102 | 7.5K | 752 | 56.0K | 563 | 430K | 434 |
| 20 | 200 | 150 | 151 | 1.1K | 112 | 8.2K | 822 | 62.0K | 623 | 470K | 474 |
| 22 | 220 | 160 | 161 | 1.2K | 122 | 9.1K | 912 | 68.0K | 683 | 510K | 514 |
| 24 | 240 | 180 | 181 | 1.3K | 132 | 10.0K | 103 | 75.0K | 753 | 560K | 564 |
| 27 | 270 | 200 | 201 | 1.5K | 152 | 11.0K | 113 | 82.0K | 823 | 620K | 624 |
| 30 | 300 | 220 | 221 | 1.6K | 162 | 12.0K | 123 | 91.0K | 913 | 680K | 684 |
| 33 | 330 | 240 | 241 | 1.8K | 182 | 13.0K | 133 | 100K | 104 | 750K | 754 |
| 36 | 360 | 270 | 271 | 2.0K | 202 | 15.0K | 153 | 110K | 114 | 820K | 824 |
| 39 | 390 | 300 | 301 | 2.2K | 222 | 16.0K | 163 | 120K | 124 | 910K | 914 |
| 43 | 430 | 330 | 331 | 2.4K | 242 | 18.0K | 183 | 130K | 134 | 1M | 105 |
| 47 | 470 | 360 | 361 | 2.7K | 272 | 20.0K | 203 | 150K | 154 | | |
| 51 | 510 | 390 | 391 | 3.0K | 302 | 22.0K | 223 | 160K | 164 | | |
| 56 | 560 | 430 | 431 | 3.3K | 332 | 24.0K | 243 | 180K | 184 | | |
| 62 | 620 | 470 | 471 | 3.6K | 362 | 27.0K | 273 | 200K | 204 | | |

TAPE & REEL INFORMATION

| Reel Diameter 7" | 740X043 | 741X043 741C083 741X083 | 742C043 742C083 742X083 | 741X163 | 742C163 | 743C043 744C043 | 743C083 744C083 | 745C101 745C102 | 745X101 745X102 | 746X101 |
|------------------|---------|-------------------------------|-------------------------------|---------|---------|--------------------|--------------------|--------------------|--------------------|---------|
| Parts Per Reel | 10,000 | 10,000 | 5,000 | 5,000 | 4,000 | 4,000 | 4,000 | 4,000 | 4,000 | 5,000 |
| Pitch | 2mm | 2mm | 4mm | 4mm | 4mm | 4mm | 4mm | 4mm | 4mm | 4mm |
| Carrier Width | 8mm | 8mm | 8mm | 8mm * | 12mm | 8mm | 12mm | 12mm | 12mm | 8mm |
| Material | Paper | Paper | Paper | Paper | Plastic | Plastic | Plastic | Plastic | Plastic | Paper |

* See Ordering Information for package code indicator.

ELECTRICAL & ENVIRONMENTAL CHARACTERISTICS

| Series | PCB Area (in ²) Per Resistor | Circuit Type | Resistance Range, Ohms | 70°C Power Per Resistor * | Maximum Operating Voltage |
|--------|--|--------------|------------------------|---------------------------|---------------------------|
| 740 | 0.0008 | Isolated | 10 - 1M | .031W | 12.5V |
| 741 | 0.0015 | Isolated | 10 - 1M | .063W | 25V |
| 742 | 0.0037 | Isolated | 10 - 1M | .063W | 50V |
| 743 | 0.0071 | Isolated | 10 - 1M | .100W | 100V |
| 744 | 0.0094 | Isolated | 10 - 1M | .125W | 200V |
| 745X | 0.0058 | Bussed | 10 - 330K | .063W | 50V |
| 745C | 0.0058 | Bussed | 100 - 470K | .063W | 50V |
| 746 | 0.0013 | Bussed | 10 - 100K | .031W | 25V |

Resistance Tolerance: Std. ±5% or 0.5Ω (whichever is greater).

See Ordering Information for other options available.

Operating Temperature Range: -55°C to +125°C.

Temperature Coefficient: ±200 ppm/°C.

* Total Rated Package Power equals total number of resistors times rated Power per Resistor

| Test | Maximum Delta R | | | Test Description |
|---------------------------|-----------------|-------|---------|--|
| | 740 | 741 | 742-746 | |
| Thermal Cycle | 1.00% | 1.00% | 1.00% | 5 Cycles -55°C to +125°C |
| Short Time Overload | 2.00% | 2.50% | 1.00% | 2½ Times Rated Working Voltage for 5 Seconds |
| Moisture Resistance | 2.00% | 5.00% | 2.00% | 240 Hours 10% rated load, -10°C to +65°C, 90% R.H. |
| High Temperature Exposure | 3.00% | 1.00% | 1.00% | 1000 Hours, no load, +125°C |
| Load Life | 3.00% | 5.00% | 2.00% | 1000 Hours @ +70°C, rated load |
| Resistance to Solder Heat | 1.00% | 2.50% | 1.00% | 10 Seconds @ +260°C solder |
| Resistance to Solvents | | | | Isopropyl alcohol, Freon TMC |
| Solderability | | | | RMA Flux, +230°C, 5 Seconds dip, 95% coverage |

PACKAGE OUTLINES

CONCAVE TERMINATION – TYPE C

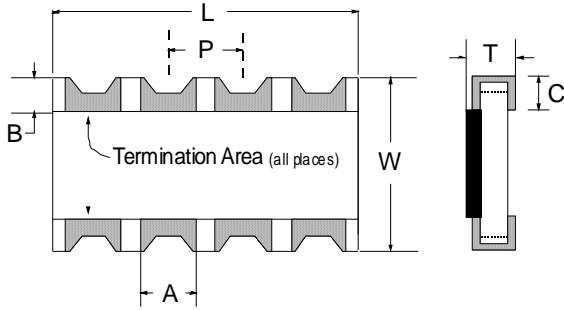

CONVEX TERMINATION – TYPE X

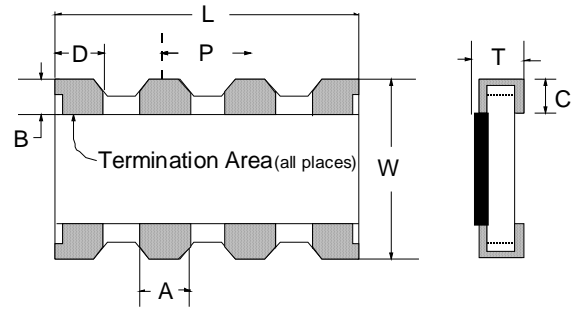

NOTES

1. Termination pads (e3). Barrier plating is nickel (Ni) with Matte tin (Sn) finish.
2. Reflow conditions per JEDEC-J-STD-020, +260°C maximum.

| Part Code | Configuration | # Pads | # Res. | Circuit | Dimensions [mm/inch] | | | | | | | | |
|-----------|---------------|--------|--------|----------|----------------------------|----------------------------|----------------------------|------------------------------|------------------------------|------------------------------|------------------------------|-------------------------------|------------------------------|
| | | | | | L | W | P [Typ.] | T | A | B | C | D | |
| 740X043 | 0201 x 2 | 4 | 2 | Isolated | 0.80 ±0.10 0.031 ±0.004 | 0.60 ±0.10 0.024 ±0.004 | 0.50 0.020 | 0.35 ±0.10 0.014 ±0.004 | 0.35 ±0.10 0.014 ±0.004 | 0.175 ±0.125 0.007 ±0.005 | 0.15 ±0.10 0.006 ±0.004 | - | |
| 741X043 | 0402 X 2 | 4 | 2 | Isolated | 1.00 ±0.20 0.039 ±0.008 | 1.00 ±0.20 0.039 ±0.008 | 0.50 0.020 | 0.35 ±0.10 0.014 ±0.004 | 0.295 ±0.135 0.012 ±0.005 | 0.20 ±0.15 0.008 ±0.006 | 0.25 ±0.10 0.010 ±0.004 | 0.33 ±0.15 0.013 ±0.006 | |
| 741X083 | 0402 X 4 | 8 | 4 | Isolated | 2.00 ±0.20 0.079 ±0.008 | | | 0.40 ±0.15 0.016 ±0.006 | 0.30 ±0.15 0.012 ±0.006 | | 0.25 ±0.20 0.010 ±0.008 | 0.40 ±0.15 0.016 ±0.006 | |
| 741C083 | 0402 X 4 | 8 | 4 | Isolated | 3.95 ±0.25 0.156 ±0.01 | | | 1.60 ±0.15 0.063 ±0.006 | 0.375 ±0.125 0.015 ±0.005 | 0.29 ±0.11 0.011 ±0.004 | 0.20 ±0.10 0.008 ±0.004 | 0.265 ±0.115 0.011 ±0.005 | N/A |
| 741X163 | 0402 X 8 | 16 | 8 | Isolated | | | | | 0.45 ±0.10 0.018 ±0.004 | 0.30 ±0.10 0.012 ±0.004 | 0.30 ±0.15 0.012 ±0.006 | 0.375 ±0.175 0.0147 ±0.007 | 0.325 ±0.175 0.013 ±0.007 |
| 742C043 | 0603 X 2 | 4 | 2 | Isolated | 1.60 ±0.20 0.063 ±0.008 | 1.60 ±0.20 0.063 ±0.008 | 0.80 0.032 | 0.525 ±0.175 0.021 ±0.007 | 0.50 ±0.15 0.020 ±0.006 | 0.30 ±0.20 0.012 ±0.008 | 0.40 ±0.15 0.016 ±0.006 | N/A | |
| 742X083 | 0603 X 4 | 8 | 4 | Isolated | 3.20 ±0.20 0.126 ±0.008 | | | 0.55 ±0.15 0.022 ±0.006 | 0.45 ±0.20 0.018 ±0.008 | | 0.275 ±0.175 0.011 ±0.007 | 0.525 ±0.225 0.021 ±0.009 | |
| 742C083 | | | | | 6.40 ±0.20 0.252 ±0.008 | | | 0.525 ±0.175 0.021 ±0.007 | 0.50 ±0.15 0.020 ±0.006 | 0.35 ±0.20 0.014 ±0.008 | N/A | | |
| 742C163 | 0603 X 8 | 16 | 8 | Isolated | 2.54 ±0.20 0.100 ±0.008 | | | 2.00 ±0.20 0.079 ±0.008 | 1.27 0.050 | 0.60 ±0.10 0.024 ±0.004 | 0.80 ±0.10 0.031 ±0.006 | 0.40 ±0.20 0.016 ±0.008 | 0.55 ±0.10 0.022 ±0.004 |
| 743C083 | 0805 X 4 | 8 | 4 | Isolated | 5.08 ±0.20 0.200 ±0.008 | 0.60 ±0.10 0.024 ±0.004 | 0.80 ±0.10 0.031 ±0.006 | | | 0.50 ±0.15 0.020 ±0.006 | 0.55 ±0.30 0.020 ±0.012 | 0.55 ±0.10 0.022 ±0.004 | N/A |
| 743C043 | 0805 X 2 | 4 | 2 | Isolated | 2.54 ±0.20 0.100 ±0.008 | 3.20 ±0.20 0.126 ±0.008 | 1.27 0.050 | 0.60 ±0.10 0.024 ±0.004 | 0.80 ±0.10 0.031 ±0.006 | 0.50 ±0.15 0.020 ±0.006 | 0.55 ±0.10 0.022 ±0.004 | N/A | |
| 744C083 | 1206 X 4 | 8 | 4 | Isolated | 5.08 ±0.20 0.200 ±0.008 | | | 0.60 ±0.10 0.024 ±0.004 | 0.80 ±0.10 0.031 ±0.006 | | 0.50 ±0.15 0.020 ±0.006 | 0.55 ±0.30 0.020 ±0.012 | 0.55 ±0.10 0.022 ±0.004 |
| 745C101 | - | 10 | 8 | Bussed | 6.40 ±0.20 0.252 ±0.008 | 3.10 ±0.30 0.126 ±0.012 | 1.27 0.050 | 0.575 ±0.125 0.025 ±0.005 | 0.60 ±0.15 0.024 ±0.006 | 0.50 ±0.15 0.020 ±0.006 | 0.55 ±0.30 0.022 ±0.012 | N/A | |
| 745X101 | | | | | 745X102 | 6.40 ±0.20 0.252 ±0.008 | | 3.20 ±0.20 0.126 ±0.008 | 0.60 ±0.10 0.024 ±0.004 | | 0.95 ±0.20 0.037 ±0.008 | 0.50 ±0.15 0.020 ±0.006 | 0.50 ±0.15 0.020 ±0.006 |
| 746X101 | - | 10 | 8 | Bussed | 3.20 ±0.20 0.126 ±0.008 | 1.60 ±0.15 0.063 ±0.006 | 0.64 0.025 | 0.60 ±0.10 0.024 ±0.004 | 0.35 ±0.05 0.014 ±0.002 | 0.30 ±0.15 0.012 ±0.006 | 0.35 ±0.15 0.014 ±0.006 | 0.45 ±0.05 0.018 ±0.002 | |

RECOMMENDED LAND PATTERNS

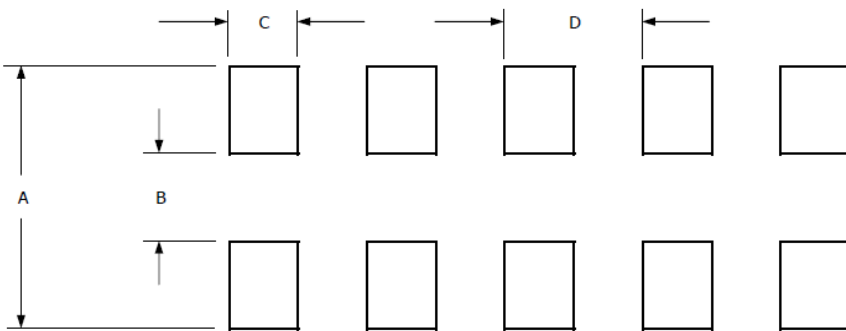

| SERIES | DIMENSIONS [mm/in] | | | |
|---------|--------------------|-------|-------|-------|
| | A | B | C | D |
| 740 | 0.900 | 0.300 | 0.300 | 0.500 |
| | 0.035 | 0.012 | 0.012 | 0.020 |
| 741X043 | 1.800 | 0.500 | 0.400 | 0.670 |
| | 0.071 | 0.020 | 0.016 | 0.026 |
| 741X083 | 1.800 | 0.500 | 0.300 | 0.500 |
| | 0.071 | 0.020 | 0.012 | 0.020 |
| 741C083 | 1.800 | 0.500 | 0.300 | 0.500 |
| | 0.071 | 0.020 | 0.012 | 0.020 |
| 741X163 | 1.800 | 0.500 | 0.300 | 0.500 |
| | 0.071 | 0.020 | 0.012 | 0.020 |
| 742 | 2.600 | 0.800 | 0.450 | 0.800 |
| | 0.102 | 0.031 | 0.180 | 0.031 |
| 743 | 3.000 | 1.000 | 0.650 | 1.270 |
| | 0.118 | 0.039 | 0.026 | 0.050 |
| 744 | 4.200 | 2.200 | 0.650 | 1.270 |
| | 0.165 | 0.087 | 0.026 | 0.050 |
| 745 | 3.900 | 2.100 | 0.900 | 1.270 |
| | 0.154 | 0.083 | 0.035 | 0.050 |
| 746 | 2.600 | 0.800 | 0.350 | 0.640 |
| | 0.102 | 0.031 | 0.014 | 0.025 |

CIRCUIT TYPES



740X043
2 Resistors
4 Terminations

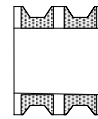

744C043
2 Resistors
4 Terminations

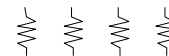
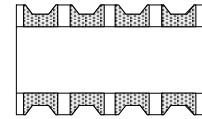

744C083
4 Resistors
8 Terminations

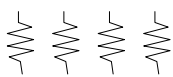
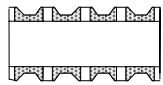

741C083
4 Resistors
8 Terminations



741X043
2 Resistors
4 Terminations

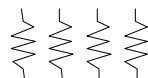
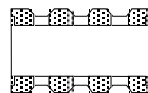

741X083
4 Resistors
8 Terminations

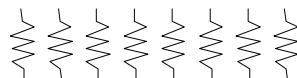
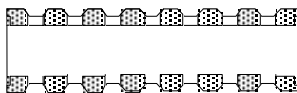

741X163
8 Resistors
16 Terminations

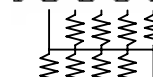
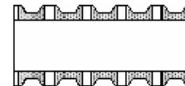

745C101
8 Resistors
10 Terminations

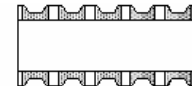

745C102
8 Resistors
10 Terminations

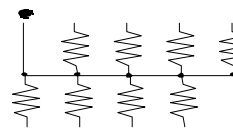
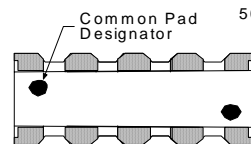

745X101
8 Resistors
10 Terminations

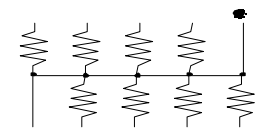
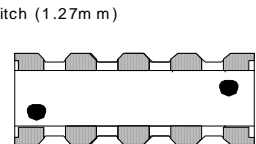

745X102
8 Resistors
10 Terminations

Note: The Marking Concept for Convex and Concave Series 745 is Different.



742C043
2 Resistors
4 Terminations

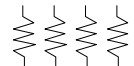
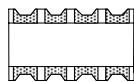

742C083
4 Resistors
8 Terminations

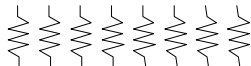
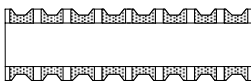

742C163
8 Resistors
16 Terminations

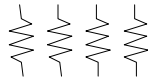
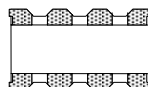

742X083
4 Resistors
8 Terminations

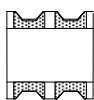

743C043
2 Resistors
4 Terminations

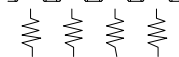
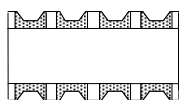

743C083
4 Resistors
8 Terminations

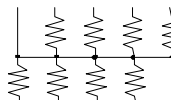
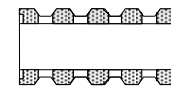

746X101
8 Resistors
10 Terminations

X-ON Electronics

Largest Supplier of Electrical and Electronic Components

Click to view similar products for [Resistor Networks & Arrays](#) category:

Click to view products by [CTS](#) manufacturer:

Other Similar products are found below :

[CS6600552K000B8768](#) [CSC08A01470KGEK](#) [M8340105K1002FGD03](#) [M8340106MA010FHD03](#) [M8340107K1471FGD03](#)
[M8340108K1001FCD03](#) [M8340108K2402GGD03](#) [M8340108K3242FGD03](#) [M8340108K3322FCD03](#) [M8340108K6192FGD03](#)
[M8340108K6202GGD03](#) [M8340109K2002FCD03](#) [M8340109M4701GCD03](#) [EXB-24N121JX](#) [EXB-24N470JX](#) [EXB-A10E102J](#) [EXB-](#)
[A10E104J](#) [744C083101JTR](#) [MDP1603100KGE04](#) [PRA100I2-1KBWNW](#) [GUS-SS4-BLF-01-1002-G](#) [ACAS06S0830339P100](#)
[ACAS06S0830343P100](#) [ACAS06S0830344P100](#) [RM2012A-102/104-PBVW10](#) [RM2012A-102503-PBVW10](#) [RM2012A-502104-PBVW10](#)
[RM3216B-102302-PBVW10](#) [L091S102LF](#) [ACAS06S0830341P100](#) [ACAS06S0830342P100](#) [ACAS06S0830345P100](#) [EXB-14V300JX](#) [EXB-](#)
[U18330JX](#) [EXB-V8V220GV](#) [PRA100I2-10KBWN](#) [PRA100I4-10KBWN](#) [M8340102M4701JAD04](#) [M8340105K1002GGD03](#)
[M8340105M1001JCD03](#) [M8340107K3402FCD03](#) [M8340108K1000FGD03](#) [M8340108K1000GGD03](#) [M8340108K1002GGD03](#)
[M8340108K2001FCD03](#) [M8340108K2002FCD03](#) [M8340108K3901GGD03](#) [M8340108K4122FGD03](#) [M8340108K4992FGD03](#)
[M8340109K2002GCD03](#)