

**RADIAL LEADED PTC  
 EX/EU MODEL**

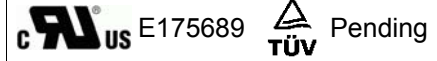

**FEATURES**

- Solid state, Radial leaded product ideal for up to 120VAC/VDC
- Operation current: 0.10A~3.75A
- Maximum Voltage: 120VAC/VDC
- Maximum Interrupt Voltage: 135VAC/VDC
- Temperature range: -40°C to 85°C
- Cured, flame retardant epoxy polymer insulating material meets UL 94V-0 requirement
- Bulk packing, tape and reel available on most models

**APPLICATIONS**

- Line voltage power supply
- Transformer and appliances product

**PART NUMBERING SYSTEM**

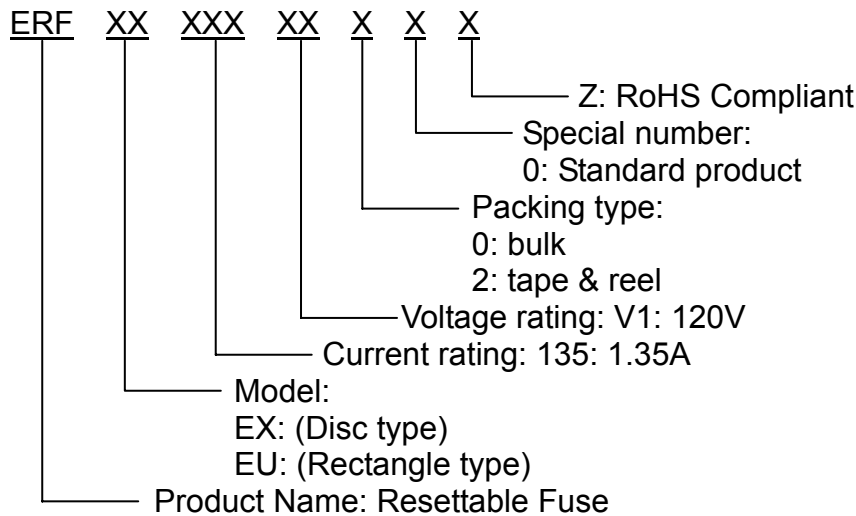

**Marking system**



Example

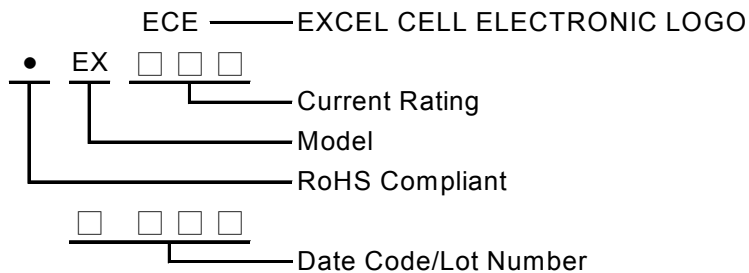

\*If the current rating is under 1Amp their will be no “ ECE ” logo shown on the body.

**NOTE: Specifications subject to change without prior notice.**

## ■ Electrical characteristics(23°C)

Part Number	Hold Current	Trip Current	Max. Time to trip	Max. Current	Max. Oper. Voltage	Max. Int. Voltage	Typical Power	Resistance Tolerance	
	I <sub>H</sub> , A	I <sub>T</sub> , A	at 5x I <sub>H</sub>	I <sub>MAX</sub> , A	V <sub>MAX</sub> , V <sub>AC/DC</sub>	V <sub>I-MAX</sub> , V <sub>AC/DC</sub>		R <sub>MIN</sub>	R <sub>1MAX</sub>
							P <sub>d</sub> , W	Ω	Ω
EX010-V1	0.10	0.20	10.0	2.0	120	135	0.84	3.00	7.50
EX017-V1	0.17	0.34	10.0	2.0	120	135	0.84	2.00	7.00
EX020-V1	0.20	0.40	9.0	2.0	120	135	1.08	1.83	4.40
EX025-V1	0.25	0.50	7.5	3.0	120	135	1.08	1.25	3.00
EX030-V1	0.30	0.60	8.5	3.0	120	135	1.44	0.88	2.10
EX040-V1	0.40	0.80	6.5	3.0	120	135	1.44	0.55	1.29
EX050-V1	0.50	1.00	6.0	3.0	120	135	1.56	0.50	1.17
EX065-V1	0.65	1.30	5.7	5.0	120	135	1.68	0.31	0.72
EX075-V1	0.75	1.50	6.3	5.0	120	135	1.80	0.25	0.60
EX090-V1	0.90	1.80	7.2	5.0	120	135	1.80	0.20	0.47
EX110-V1	1.10	2.20	8.2	8.0	120	135	2.28	0.15	0.38
EX135-V1	1.35	2.70	9.6	10.0	120	135	2.64	0.12	0.30
EX160-V1	1.60	3.20	11.4	12.0	120	135	3.12	0.09	0.22
EX185-V1	1.85	3.70	12.6	12.0	120	135	3.36	0.08	0.19
EX250-V1	2.50	5.00	15.6	15.0	120	135	4.44	0.05	0.13
EX300-V1	3.00	6.00	19.8	17.0	120	135	4.56	0.04	0.10
EX375-V1	3.75	7.50	24.0	20.0	120	135	4.80	0.03	0.08
EU075-V1	0.75	1.50	15.0	7.5	120	135	2.64	0.25	0.69
EU100-V1	1.00	2.00	15.0	10.0	120	135	2.64	0.18	0.47
EU125-V1	1.25	2.50	20.0	12.5	120	135	2.88	0.11	0.33
EU135-V1	1.35	2.70	20.0	13.5	120	135	3.12	0.11	0.30
EU200-V1	2.00	4.20	36.0	20.0	120	135	4.32	0.08	0.21

I<sub>H</sub>=Hold current-maximum current at which the device will not trip at 23°C still air.  
I<sub>T</sub>=Trip current-minimum current at which the device will always trip at 23°C still air.  
V<sub>MAX</sub>=Maximum voltage device can withstand without damage at its rated current.  
I<sub>MAX</sub>= Maximum fault current device can withstand without damage at rated voltage (V max).  
P<sub>d</sub>=Typical power dissipated from device when in the tripped state in 23°C still air environment.  
R<sub>MIN</sub>=Minimum device resistance at 23°C.  
R<sub>1MAX</sub>=Maximum device resistance at 23°C 1 hour after tripping .

**NOTE: Specifications subject to change without prior notice.**

■ **Typical Time-To-Trip at 23°C**

- A=EX010-V1
- B=EX017-V1
- C=EX020-V1
- D=EX025-V1
- E=EX030-V1
- F=EX040-V1
- G=EX050-V1
- H=EX065-V1
- I=EX075-V1
- J=EX090-V1
- K=EX110-V1
- L=EX135-V1
- M=EX160-V1
- N=EX185-V1
- O=EX250-V1
- P=EX300-V1
- Q=EX375-V1

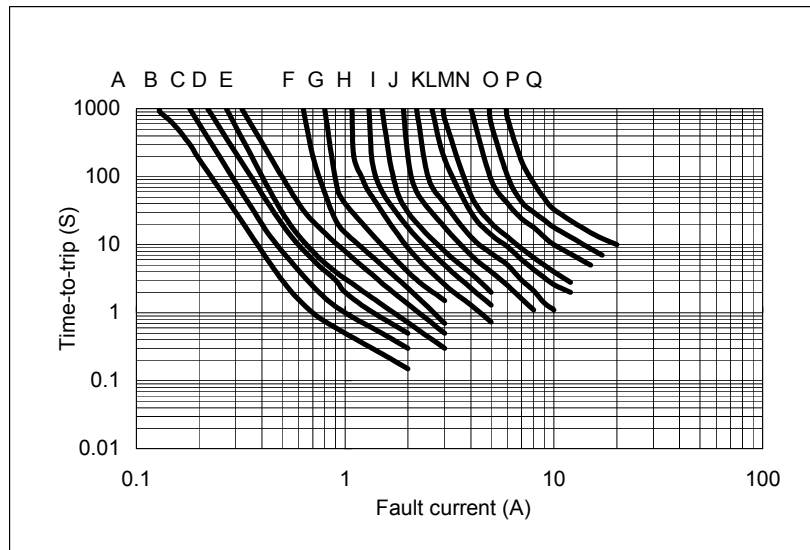

- R=EU075-V1
- S=EU100-V1
- T=EU125-V1
- U=EU135-V1
- V=EU200-V1

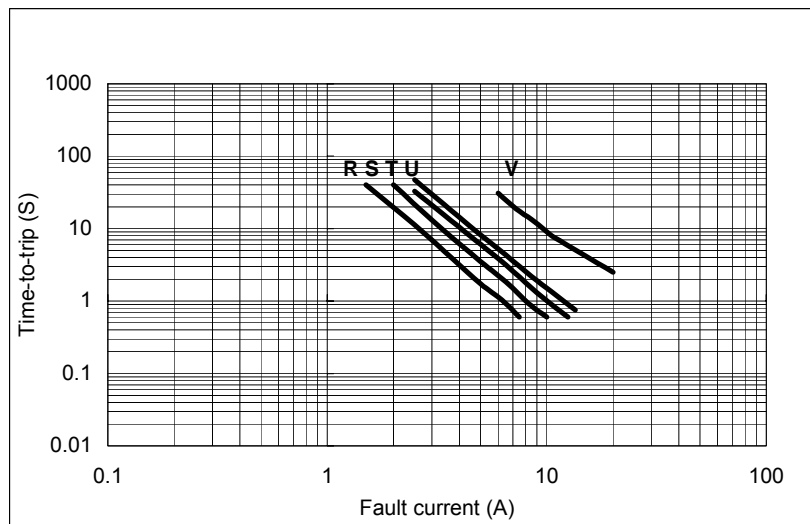

■ **Thermal Derating Curve**

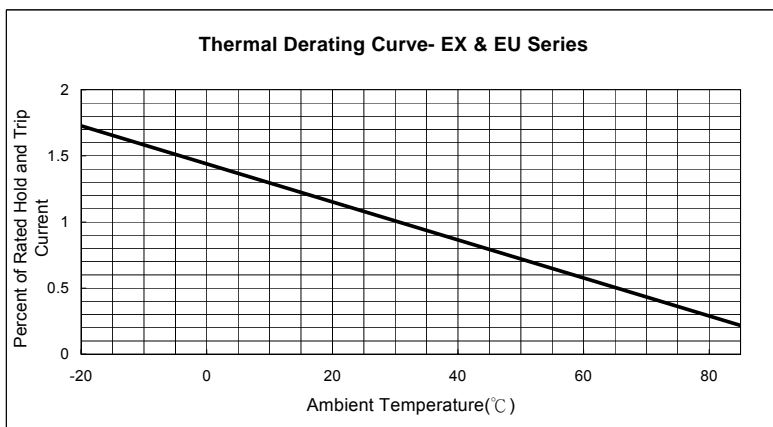

**NOTE: Specifications subject to change without prior notice.**

■ **EX/EU Product Dimensions (UNIT: mm)**

Part Number	A	B	C	D	E	F	Figure
	Maximum	Maximum	Typical	Minimum	Maximum	Typical	
EX010-V1	7.9	13.0	5.1	7.6	3.8	2.2	1
EX017-V1	7.9	13.0	5.1	7.6	3.8	2.2	1
EX020-V1	7.9	13.0	5.1	7.6	3.8	2.2	2
EX025-V1	7.9	13.0	5.1	7.6	3.8	2.2	2
EX030-V1	7.9	13.0	5.1	7.6	3.8	2.2	2
EX040-V1	8.2	14.2	5.1	7.6	3.8	2.2	2
EX050-V1	9.2	14.9	5.1	7.6	3.8	2.2	2
EX065-V1	9.7	14.9	5.1	7.6	3.8	2.2	2
EX075-V1	10.6	15.5	5.1	7.6	3.8	2.2	2
EX090-V1	11.9	15.9	5.1	7.6	3.8	2.2	2
EX110-V1	13.3	18.3	5.1	7.6	4.1	2.2	3
EX135-V1	15.5	20.6	5.1	7.6	4.1	2.2	3
EX160-V1	17.5	22.5	5.1	7.6	4.1	2.2	3
EX185-V1	19.9	24.9	5.1	7.6	4.1	2.2	3
EX250-V1	22.5	27.5	10.2	7.6	4.1	2.2	3
EX300-V1	25.5	30.0	10.2	7.6	4.1	2.2	3
EX375-V1	29.5	34.0	10.2	7.6	4.1	2.2	3
EU075-V1	10.9	17.0	5.1	7.6	4.1	2.2	4
EU100-V1	11.5	20.1	5.1	7.6	4.1	2.2	4
EU125-V1	14.0	21.7	5.1	7.6	4.1	2.2	4
EU135-V1	16.3	21.7	5.1	7.6	4.1	2.2	4
EU200-V1	23.5	27.9	10.2	7.6	4.1	2.2	4

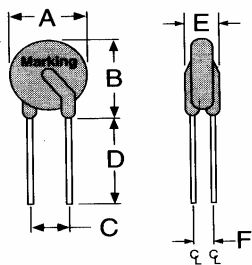

Figure 1

● Lead Size: 24AWG  
 ●  $\Phi 0.51$ mm Diameter

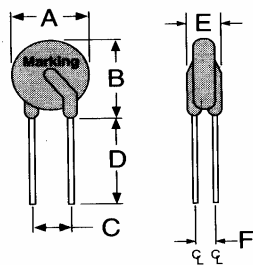

Figure 2

● Lead Size: 22AWG  
 ●  $\Phi 0.65$ mm Diameter

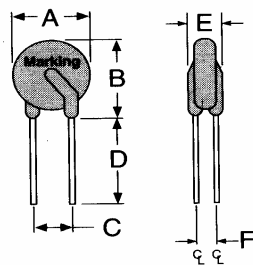

Figure 3

● Lead Size: 20AWG  
 ●  $\Phi 0.81$ mm Diameter

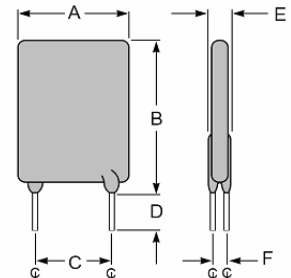

Figure 4

● Lead Size: 20AWG  
 ●  $\Phi 0.81$ mm Diameter

**NOTE: Specifications subject to change without prior notice.**

## X-ON Electronics

Largest Supplier of Electrical and Electronic Components

*Click to view similar products for [Specialty Fuses](#) category:*

*Click to view products by [ECC manufacturer](#):*

Other Similar products are found below :

[63NZ02GL](#) [714125](#) [722134](#) [80NH00GR-6](#) [FWH-200A](#) [FWP-32A14F](#) [FWP-50](#) [HBM-25](#) [12LCT](#) [12TDLSJ63](#) [REN-3](#) [15.5CAVH2E](#) [ECF-2](#)  
[ECF-4](#) [ECF-6](#) [170M0213](#) [170M1314](#) [170M1369-D](#) [170M3809D](#) [BK/F02A-2AS](#) [BK/F02B-1A](#) [N-2-1/2](#) [N-3-2/10](#) [NITD2](#) [20D16](#) [20D16SC](#)  
[20D27FB](#) [KAA-3](#) [KAB-2](#) [KAB-30](#) [KAJ-60](#) [KAW-3](#) [2D16](#) [LKN-125B](#) [16D27SB](#) [170M1564D](#) [170M2616](#) [170M2668](#) [170M4161](#)  
[170M4241](#) [170M4699](#) [ESD63](#) [ABS-25](#) [ABS-30](#) [ABS-8](#) [ACF-15](#) [ACF-30](#) [ACO-30](#) [SSD10](#) [200NH1M](#)