

3MS/3MN/3MA

3M-Series

MINIATURE PUSHBUTTONS

The 3M family of miniature pushbutton switches is composed of four switch series; the **3MNH-Series** premium sealed snap-action pushbutton, the **3MN-Series** snap-action pushbutton, the **3MS-Series** sealed snap-action pushbutton, and the **3MA-Series** alternate-action pushbutton. These PC mount pushbutton switches offer a variety of ratings, circuits, contact materials, terminal platings, pushbutton styles, and optional color caps.

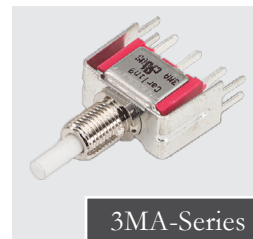

Product Highlights:

- IP67 Sealing
- Snap Action Contact Mechanism
- Variety of Plunger and Bushing Lengths
- Up to 14 Termination Choices
- UL and cUL Approvals
- Sleek Black Finish

Typical Applications:

- Telecommunications
- Performance Audio
- Networking
- Computers
- Instrumentation
- Low Power On/Off Designs

Resources:

[Configure a Complete Part](#)

[Download CAD & Sales Drawing >](#)



Carling Technologies®

Innovative Designs. Powerful Solutions.

Carling Technologies, Inc.
60 Johnson Avenue, Plainville, CT 06062
Email: sales@carlingtech.com
Application Support: team2@carlingtech.com
Phone: 860.793.9281 Fax: 860.793.9231

www.carlingtech.com



3MNH-Series
Premium Sealed
Miniature Pushbutton Switch

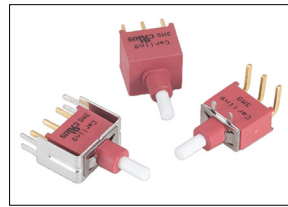

3MS-Series
Sealed Snap-Action
Miniature Pushbutton Switch



3MN-Series
Snap-Action
Miniature Pushbutton Switch

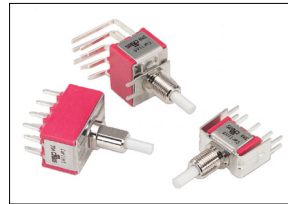

3MA-Series
Alternate Action
Miniature Pushbutton Switch

Electrical

Contact Rating	refer to ordering scheme
Electrical Life	50,000 make & break cycles @ full load
Contact Resistance	<i>3MS-Series:</i> 50 mΩ max. initial @ 2-4 VDC 100mA for both silver & gold plated contacts. <i>3MN, 3MA & 3NMH-Series:</i> 10 mΩ max. initial @ 2-4 VDC 100mA for both silver & gold plated contacts.
Insulation Resistance	1000 MΩ min.
Dielectric Strength	1500 Volts RMS @ sea level

Physical

Operating Temperature	-30°C to +85°C
Index of Protection	<i>3MS-Series:</i> IP68 <i>3MNH-Series:</i> IP67
Cap Installation Support	<i>3MS-Series:</i> 10 lbs. max.
Solder Heat Resistance	MIL-STD-202, Method 210

Material

Case	<i>3MS-Series:</i> Glass filled nylon 6/6, flame retardant, heat stabilized (UL94V-0) <i>3MN, 3MA & 3NMH-Series:</i> Dially phthalate (DAP) (UL 94V-0)
Plunger	<i>3MS & 3MA-Series:</i> Glass filled nylon or glass filled polyester (UL94V-0) <i>3MN-Series:</i> Thermoplastic polyester, black <i>3NMH-Series:</i> Brass, black finish with o-ring seal
Bushing	<i>3MN-Series:</i> Brass, nickel plated <i>3MA-Series:</i> Zinc, nickel plated <i>3NMH-Series:</i> Brass, black finish with o-ring seal
Housing	<i>3MN & 3MA-Series:</i> Stainless Steel
Switch Support Retainer	<i>3MS-Series:</i> Stainless Steel
Terminal Seal	Epoxy

*Manufacturer reserves the right to change product specification without prior notice.

3MNH - **DP** **1** - **PJ** - **BJ** - **M2** - **Q** **E**

1 Series 2 Pole 3 Circuit 4 Plunger 5 Bushing 6 Termination 7 Contacts 8 Seal

1 SERIES

3MNH Premium Sealed Miniature Pushbutton Switch

2 POLES

SP Single pole - uses terminals 1, 2 & 3
DP Double pole - uses terminals 1, 2, 3, 4, 5 & 6

3 CIRCUIT

() - momentary

Switching Position:	1	2
1	ON	ON
7	ON	(ON)

Note: Plunger at rest in Position 1. Plunger depressed in Position 2.

4 PLUNGER 1

PJ .325 height [8.25 mm]
PA .157 height [4.00 mm]
PB .354 height [9.00 mm]



5 BUSHING 2

BJ³ Threaded 15/32, flat, .553 height [14.05 mm]
BL⁴ Threaded 15/32, flat, .295 height [7.49 mm]

6 TERMINATION

M1 Solder Lug
M2 PC thru-hole
M51 Wire wrap, .711" [18.05 mm]
M52 Wire wrap, .924" [23.48 mm]
M53 Wire wrap, .386" [9.80 mm]

7 CONTACTS / TERMINALS

	Contact Material	Terminal Plating	Rating	Approvals
G	silver ⁵	gold over silver	(SP1, DP1) 6A@125VAC or 28VDC 3A@250VAC (SP7, DP7) 1A@120VAC or 38VDC	 us, IP67
Q	silver ⁵	silver ⁵	(SP1, DP1) 6A@125VAC or 28VDC 3A@250VAC (SP7, DP7) 1A@120VAC or 38VDC	 us, IP67
R	gold ⁶	gold ⁷	0.4VA max @ 20V max (AC/DC)	N/A

8 EPOXY SEAL

E Epoxy Seal

Notes:

- 1 PJ Plunger for maintained circuits only. PA and PB Plunger for momentary circuits only
- 2 Hardware includes (1) 2M1-HDW4 nut and (1) 3MNH-WCP-0872 o-ring
- 3 BJ Bushing only available with PJ Plunger
- 4 BL Bushing only available with PA or PB Plunger
- 5 Movable contact & terminal platings: silver over copper alloy
- 6 Movable Contact platings: gold over nickel over copper alloy
- 7 Terminal platings: gold over nickel over copper alloy

3MS - **WSP** **7** - **P1** - **B1** - **M6** **Q** **E**

1 Series 2 Pole 3 Circuit 4 Actuator Style 5 Bushing 6 Termination 7 Contacts 8 Seal

1 SERIES

3MS Sealed Snap-Action Miniature Pushbutton Switch

2 POLES

WSP Single pole - uses terminals 1, 2 & 3
WDP Double pole - uses terminals 1, 2, 3, 4, 5 & 6

3 CIRCUIT

() - momentary

Switching Position:	1	2
7	2-3, 5-6 ON	2-1, 5-4 (ON)

Note: Plunger at rest in Position 1. Plunger depressed in Position 2.

4 ACTUATOR STYLE

P1 Standard Plunger
P2 Long Plunger
P3 Short Plunger



5 BUSHING

B1¹ Threaded, with keyway, .350 height [8.89 mm]
B4 Unthreaded, flattened, .250 height [6.35 mm]

6 TERMINATION

M1 Solder Lug
M2 PCB
M6 PC Mount, 90° horizontal
M61 Snap-In, 90° horizontal
M7 PC Mount, 90° vertical
M71 Snap-In, 90° vertical
VS2 PC Mount, U bracket, .620" mounting x .461" height
VS21 Snap-In, U bracket, .620" mounting x .461" height
VS3 PC Mount, U bracket, .620" mounting x .630" height
VS31 Snap-In, vertical, .630" height
VS4 PC Mount, U bracket, .750" mounting x .461" height
VS41 Snap-In, vertical, .461 height
VS5 PC Mount, U bracket, .750" mounting x .630" height
VS51 Snap-In, vertical, .630" height

7 CONTACTS / TERMINALS

	Contact Material	Terminal Plating	Rating	Approvals
G	silver ³	gold over silver	1A 120VAC or 38VDC	 us, IP68
Q	silver ³	silver ³	1A 120VAC or 38VDC	 us, IP68
R	gold ²	gold ²	0.4VA max 20V max (AC/DC)	IP68

8 EPOXY SEAL

E Epoxy Seal **0** without Epoxy Seal

Notes:

- 1 Hardware includes (2) 2M1-HDW2 nuts, (1) 2M1-HDW11 washer, and (1) 2M1-HDW15 locking ring
- 2 Movable contact and terminal platings: gold over nickel over copper alloy
- 3 Movable contact and terminal platings: silver over copper alloy

3MN-Series with Square Actuator

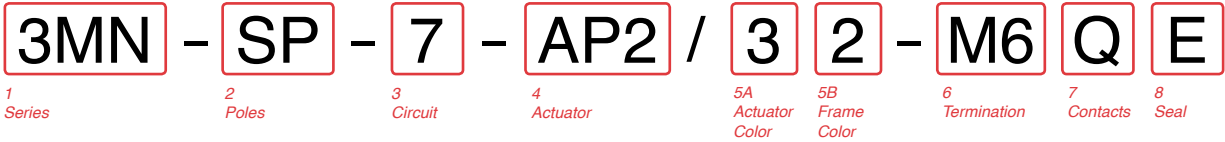

3MN-Series with Plunger Actuator

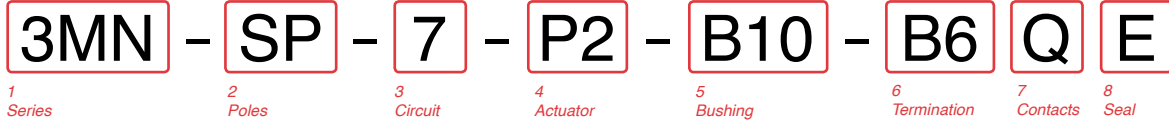

1 SERIES

3MN Snap-Action Miniature Pushbutton Switch

2 POLES

SP Single pole - uses terminals 1, 2 & 3
DP Double pole - uses terminals 1, 2, 3, 4, 5 & 6

3 CIRCUIT

() - momentary

Switching Position:

	1	2
7	2-3, 5-6	2-1, 5-4
	ON	(ON)

Note: Plunger at rest in Position 1. Plunger depressed in Position 2.

4 ACTUATOR

Square Actuator (use with Color Options in Selection 5A & 5B)

AP1 Square with no frame
AP2 Square raised above frame
AP3 Square flush with frame

Plunger Actuator (use with Bushing Options in Selection 5)

P0 Flush Plunger
P1 Standard Plunger
P2 Short Plunger

5A ACTUATOR COLOR & 5B FRAME COLOR 3,4

1 White
2 Black
3 Red

OR

5B BUSHING

B6 Unthreaded (for terminations VS6-VS9 only)
B10¹ Threaded keyway
B11² Threaded with flat
B20 Unthreaded keyway
B21 Unthreaded with flat

6 TERMINATION

M1 Solder Lug
M2 PCB
M51 Wire Wrap .750 [19.05]
M52 Wire Wrap .964 [24.40]
M53 Wire Wrap .425 [10.80]
M6 PC Mount, 90° horizontal
M7 PC Mount, 90° vertical
VS2 PC Mount, U bracket, .620" mounting x .461" height
VS3 PC Mount, U bracket, .620" mounting x .630" height
VS4 PC Mount, U bracket, .750" mounting x .461 height
VS5 PC Mount, U bracket, .750" mounting x .630" height
VS6 PC Mount, U bracket, .461 height (for B6 bushing only)
VS7 PC Mount, U bracket, .630 height (for B6 bushing only)
VS8 PC Mount, U bracket, .461 height (for B6 bushing only)
VS9 PC Mount, U bracket, .630 height (for B6 bushing only)

7 CONTACTS / TERMINALS

	Contact Material	Terminal Plating	Rating	Approvals
G	silver	gold over silver	1A 125VAC or 28VDC	
Q	silver ⁵	silver ⁵	1A 125VAC or 28VDC	
R	gold ⁶	gold ⁶	0.4VA max 20V max (AC/DC)	

8 EPOXY SEAL

E Epoxy Seal **0** without Epoxy Seal

Notes:

- Hardware includes (2) 2M1-HDW2 nuts, (1) 2M1-HDW11 washer, and (1) 2M1-HDW15 locking ring
- Hardware includes (2) 2M1-HDW2 nuts, (1) 2M1-HDW11 washer, and (1) 2M1-HDW16 locking ring
- Selection 5B is blank if actuator style is AP1 (no frame)
- Black, white and red are standard. Other colors available, consult factory for details.
- Movable contact & terminal platings: silver over copper alloy
- Movable contact & terminal platings: gold over nickel over copper alloy

3MA-Series with Square Actuator



3MA-Series with Plunger Actuator



1 SERIES

3MA Alternate Action Miniature Pushbutton Switch

2 POLES

SP Single pole - uses terminals 1, 2 & 3
DP Double pole uses terminals 1,2, 3, 4, 5 & 6
3P¹ Three pole uses terminals 1,2, 3, 4, 5, 6, 7, 8 & 9
4P¹ Four pole uses terminals 1,2, 3, 4, 5, 6, 7, 8, 9, 10, 11, 12

3 CIRCUIT

() - momentary
Switching 1 **2** **3**
Position: 2-3, 5-6, 8-9, 11-12 Connected Terminals 2-1, 5-4, 8-7, 11-10
1 ON NONE ON
2* ON NONE (ON)

*Available in SP & DP only.

4 ACTUATOR

Square Actuator (use with Color Options in Selection 5A & 5B)

AP1 Square with no frame
AP2 Square raised above frame

Plunger Actuator (use with Bushing Options in Selection 5)

PA Standard Plunger
PI Medium Plunger
PL Brass Chrome Plunger
PC Brass Chrome Plated Plunger with Cap (for BD bushing only)
PD Brass Chrome Plated Plunger (for BD bushing only)

5A ACTUATOR COLOR & 5B FRAME COLOR 4.5

1 White	4 Orange	7 Blue
2 Black	5 Yellow	8 Brown
3 Red	6 Green	9 Gray

OR

5 BUSHING

BD¹ Big bushing for PC, PD actuator 15/32"
B10² Threaded 1/4 - 40
B20 Unthreaded
B21 Unthreaded with flat

6 TERMINATION

M1 Solder Lug
M2 PCB
M51 Wire Wrap .750
M52 Wire Wrap .964
M53 Wire Wrap .425
M54 Wire Wrap 1.062
M6 PC Mount, 90° horizontal
M7 PC Mount, 90° vertical
VS2 PC Mount, U bracket, .620" mounting x .461" height
VS3 PC Mount, U bracket, .620" mounting x .630" height
VS4 PC Mount, U bracket, .750" mounting x .461" height
VS5 PC Mount, U bracket, .750" mounting x .630" height

7 CONTACTS / TERMINALS

	Contact Material	Terminal Plating	Rating	Approvals
G	silver ⁶	gold over silver	6A 125VAC or 28VDC 3A 250VAC	us
K	gold ⁷	tin ⁸	0.4VA max 20V max (AC/DC)	N/A
P	silver ⁶	gold over silver	6A 125VAC or 28VDC 3A 250VAC	us
Q	silver ⁶	silver ⁶	6A 125VAC or 28VDC 3A 250VAC	us
R	gold ⁷	gold ⁷	0.4VA max 20V max (AC/DC)	N/A

8 EPOXY SEAL

E Epoxy Seal **0** without Epoxy Seal

Notes:

- Hardware includes (2) 2M1-HDW2 nuts, (1) 2M1-HDW12 washer, and (1) 2M1-HDW17 locking ring
- Hardware includes (2) 2M1-HDW2 nuts, (1) 2M1-HDW11 washer, and (1) 2M1-HDW15 locking ring
- Tin option available with PC type terminations only.
- Available with circuit 1 only
- Black, white and red are standard. Other colors available, consult factory for details.
- Selection 5B is blank if actuator style is AP1 (no frame)
- Movable contact & terminal platings: silver over copper alloy
- Movable contact & terminal platings: gold over nickel over copper alloy
- Terminal platings: tin over nickel over copper alloy, available for PC mount terminations only

3M-Series Accessories

To order a cap assembled on a switch, specify the switch number followed by the cap part number and the word "assembled". Ex: 3MN-SP-7-P2-B6-M6QE-C13ASSEMBLED. To order caps in bulk, specify the Series, followed by the cap. Ex: 3MN-C13

Optional Cap

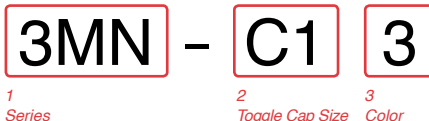

1 SERIES

3MN Fits 3MN, 3MS or 3MA

2 PUSHBUTTON CAP SIZE

C1 Round 8 mm diameter	C5 ¹ Round 15 mm diameter
C2 Round 9.70 mm diameter	C6 ² Brass Chrome Plated, 3.15 mm diameter
C3 Square 11.7 x 11.7 mm	
C4 Round 5 mm diameter	

3 CAP COLOR

1 White	4 Orange
2 Black	5 Yellow
3 Red	6 Green
	7 Blue

Notes:

- For 3MA with PL Bushing
- For 3MA with PD Bushing

3MNH-Series Dimensional Specifications: in. [mm]

Single Pole Maintained Circuit

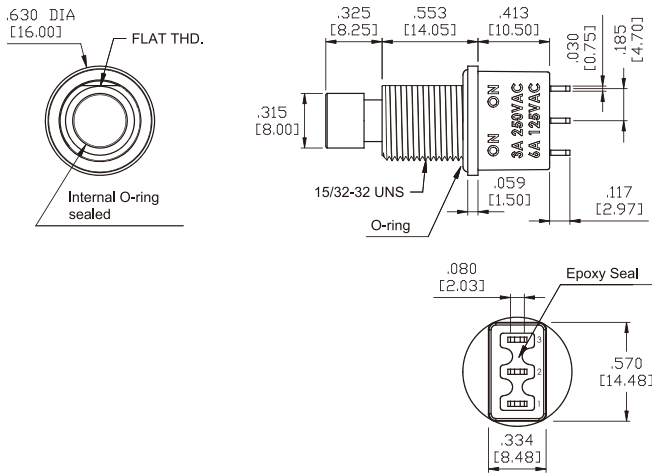

Single Pole Momentary Circuit

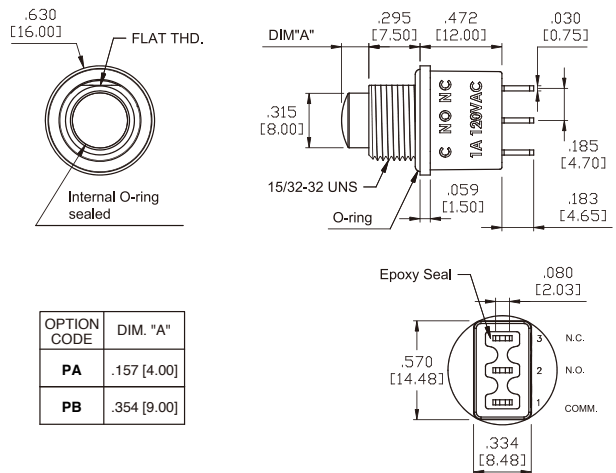

Double Pole Maintained Circuit

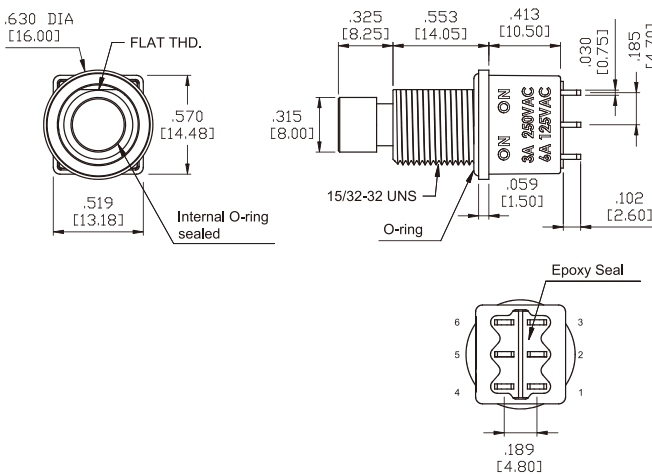

Double Pole Momentary Circuit

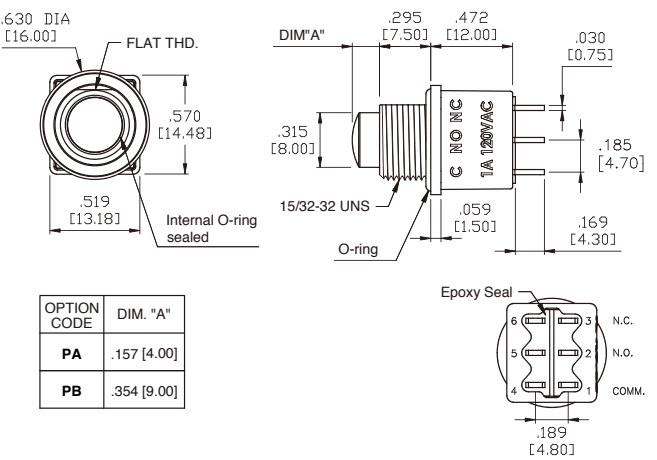

Panel Mounting

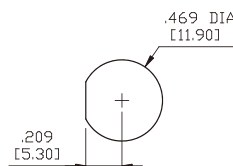

15/32-32 UNS FLAT-CUT THREADED BUSHING

M1 Standard Solder Lug

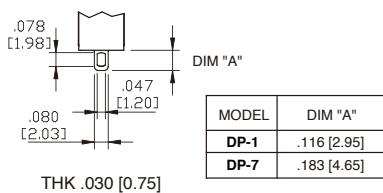

Termination Options

M2 PC Thru-Hole

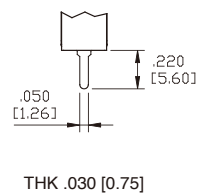

M5 Wire Wrap

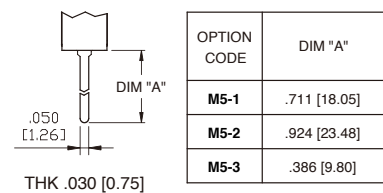

3MS-Series Dimensional Specifications: in. [mm]

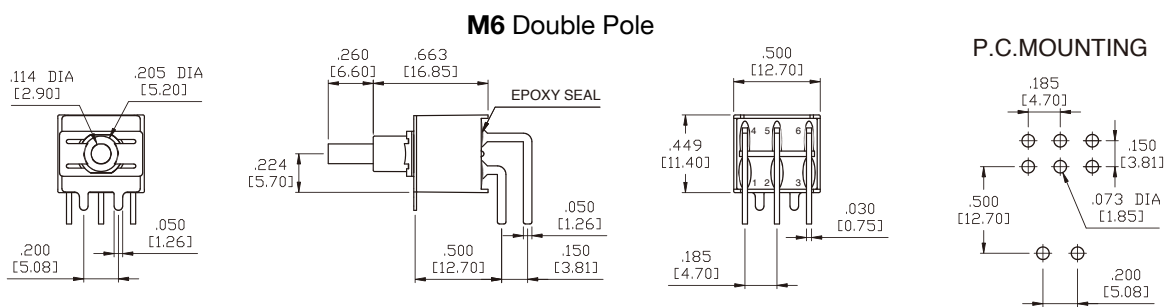
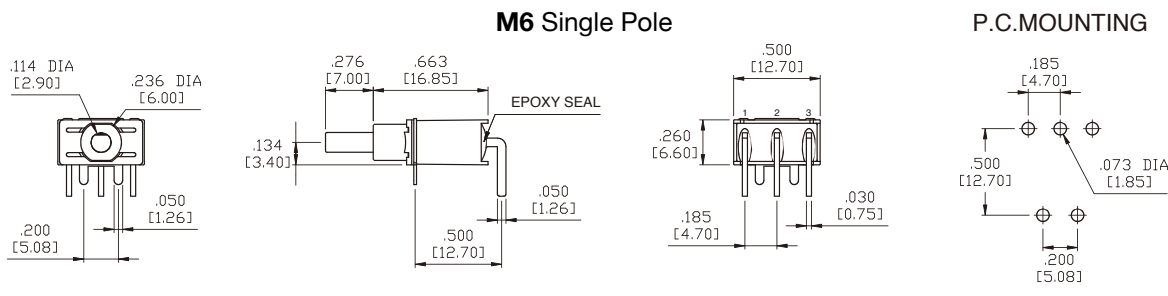
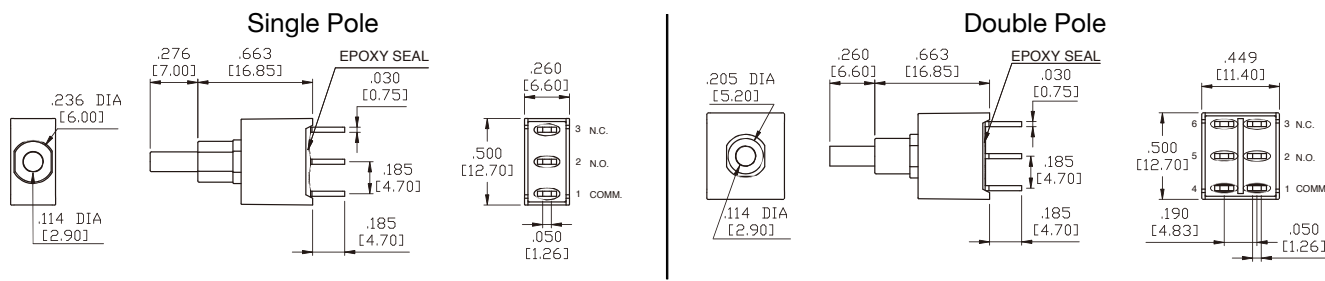

Plunger Options

For **B1** Bushing

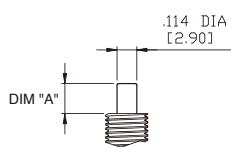

OPTION CODE	DIM. "A"
P1	.181 [4.60]
P2	.228 [5.80]
P3	.087 [2.20]

For **B4** Bushing

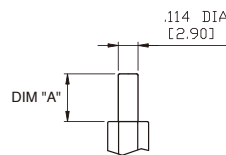

OPTION CODE	DIM. "A"
P1	.276 [7.00]
P2	.323 [8.20]
P3	.181 [4.60]

Bushing Options

B1

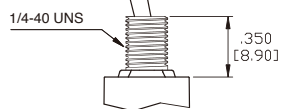

B4

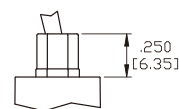

3MS-Series Dimensional Specifications: in. [mm]

Termination Options

M1

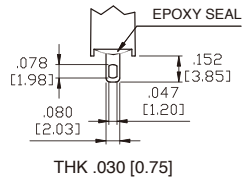

M2

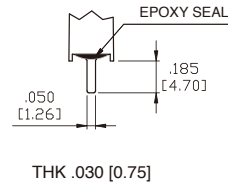

M7 Single Pole

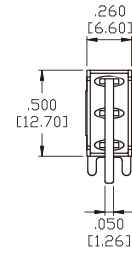
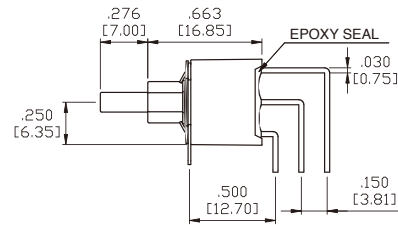
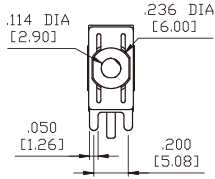

P.C.MOUNTING

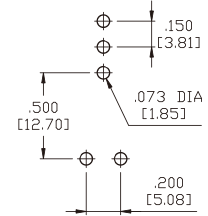

M7 Double Pole

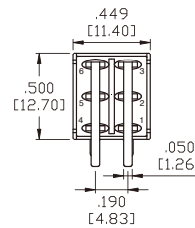
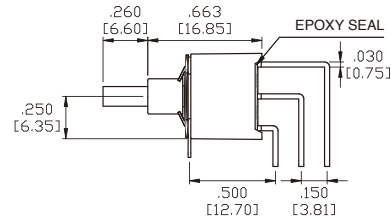
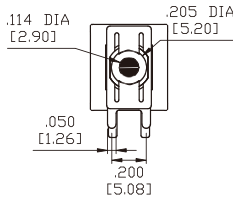

P.C.MOUNTING

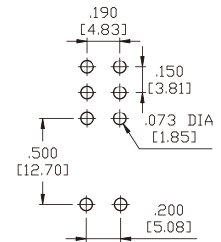

VS2-VS3 Single Pole

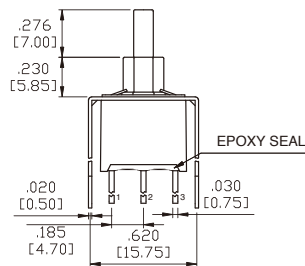
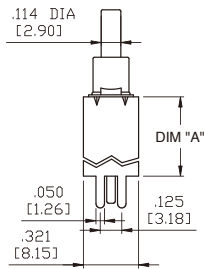

OPTION CODE	DIM. 'A'
VS2	.461 [11.70]
VS3	.630 [16.00]

P.C.MOUNTING

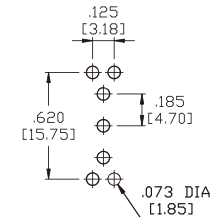

VS2-VS3 Double Pole

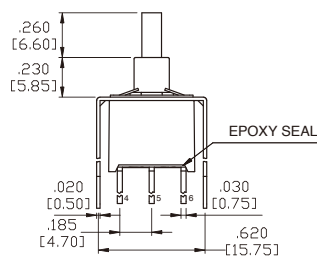
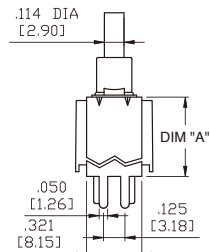

OPTION CODE	DIM. 'A'
VS2	.461 [11.70]
VS3	.630 [16.00]

P.C.MOUNTING

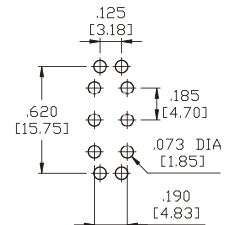

3MS-Series Dimensional Specifications: in. [mm]

Termination Options

VS4-VS5 Single Pole

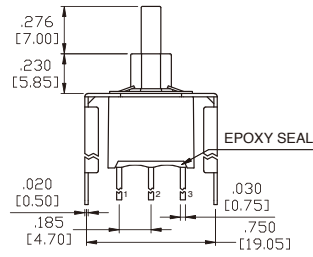
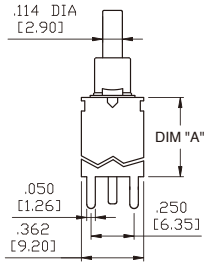

OPTION CODE	DIM. 'A'
VS4	.461 [11.70]
VS5	.630 [16.00]

P.C. MOUNTING

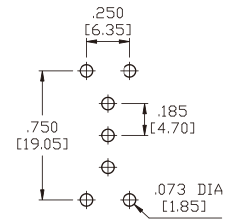

VS4-VS5 Double Pole

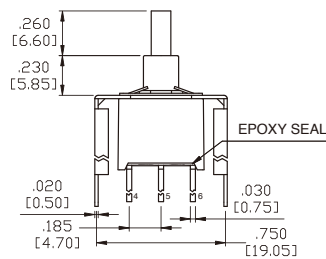
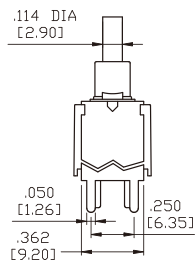

OPTION CODE	DIM. 'A'
VS4	.461 [11.70]
VS5	.630 [16.00]

P.C. MOUNTING

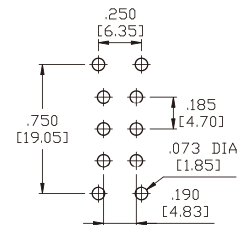

Snap-In Termination Options

M61

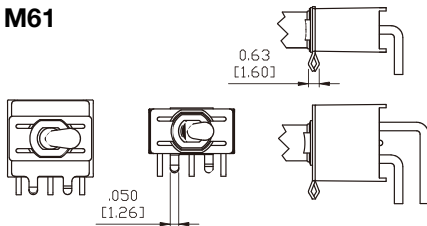

VS21, VS31

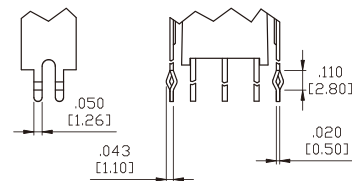

M71

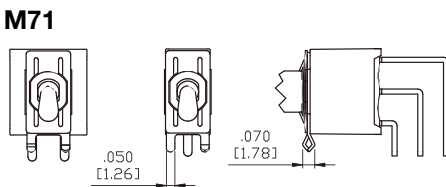

VS41, VS51

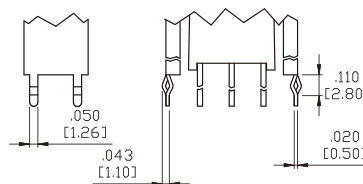

* PC Mounting for M61, M71, VS21, VS31, VS41, VS51 refer to M6, M7, VS2, VS3, VS4, VS5 respectively.

3MN-Series Dimensional Specifications: in. [mm]

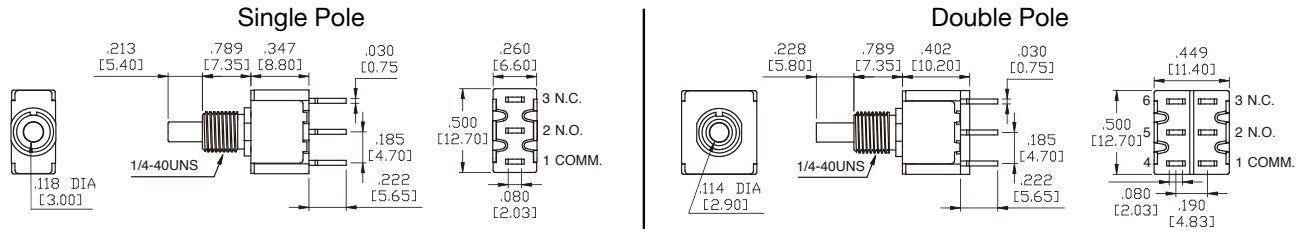

Plunger Options

For B1, B2, B3, B4 Bushing

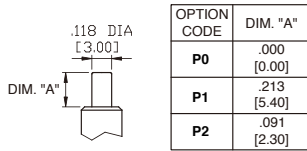

For B6 Bushing

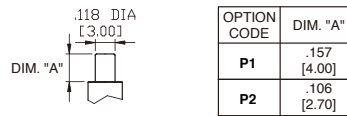

AP1

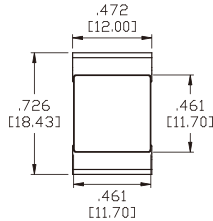

Actuator Options for Snap-In Front Mount

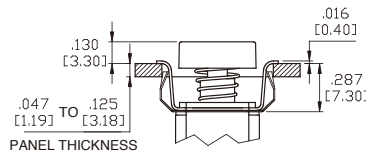

PANEL MOUNTING

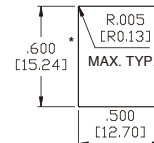

* Increase this dimension to .620/.625 [15.75/15.88] for .091/.125 [2.31/3.18] thk. panels.

AP2 with Frame

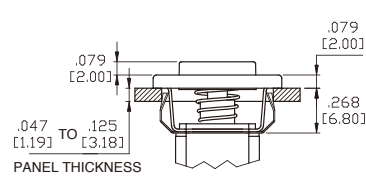
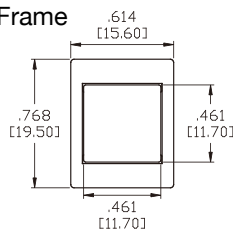

PANEL MOUNTING

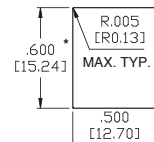

* Increase this dimension to .620/.625 [15.75/15.88] for .091/.125 [2.31/3.18] thk. panels.

AP3 Flush CAP

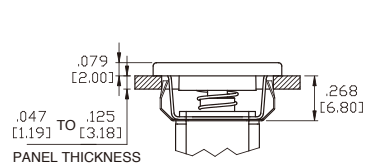
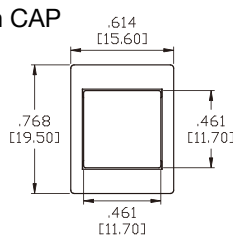

PANEL MOUNTING

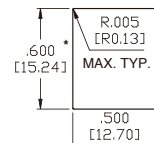

* Increase this dimension to .620/.625 [15.75/15.88] for .091/.125 [2.31/3.18] thk. panels.

Bushing Options

B1 Threaded Standard
B2 Non-Threaded

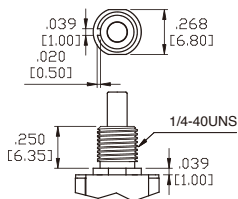

B3 Threaded Standard
B4 Non-Threaded

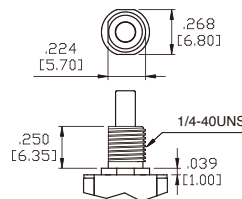

B6 Non-Threaded
(FOR TERMINATION OPTIONS VS6-VS9 ONLY)

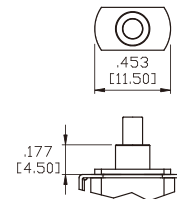

3MN-Series Dimensional Specifications: in. [mm]

Termination Options

M1 Standard Solder Lug

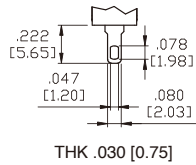

M2 PC Thru-Hole

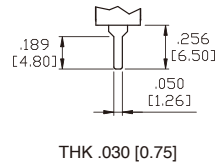

M5 Wire Wrap

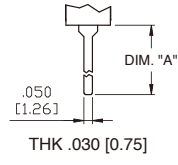

OPTION CODE	DIM. "A"
M5-1	.750 [19.05]
M5-2	.964 [24.48]
M5-3	.425 [10.80]

M6 Single Pole

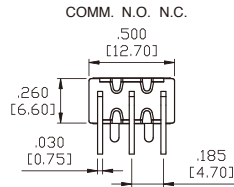
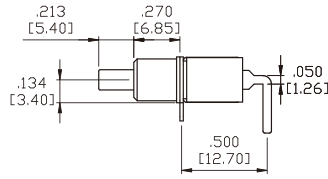
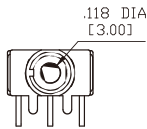

P.C.MOUNTING

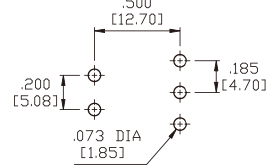

M6 Double Pole

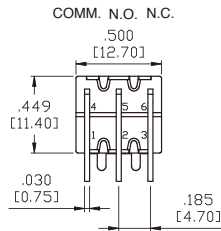
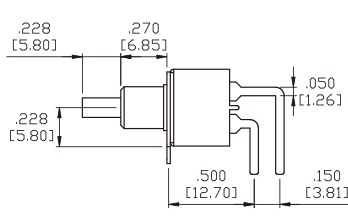
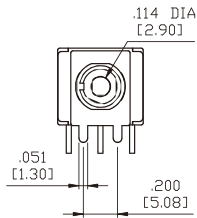

P.C.MOUNTING

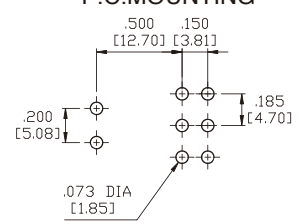

M7 Single Pole

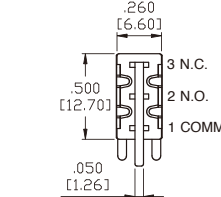
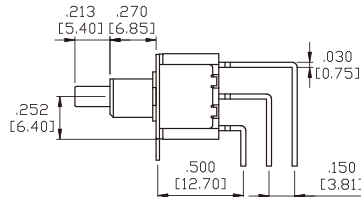
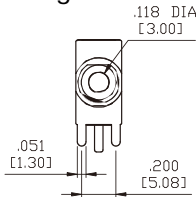

P.C.MOUNTING

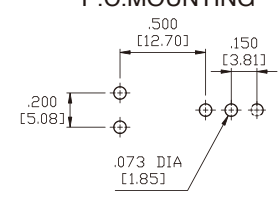

M7 Double Pole

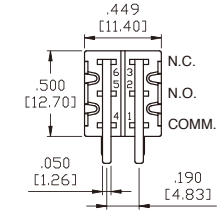
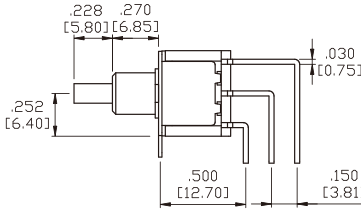
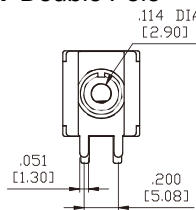

P.C.MOUNTING

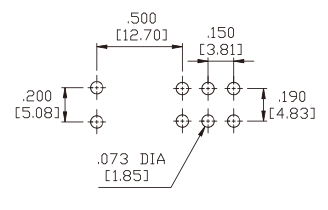

VS2-VS3 Single Pole

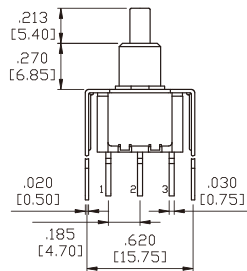
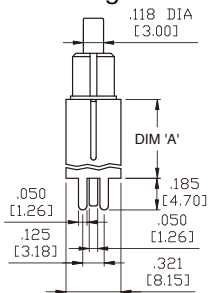

OPTION CODE	DIM. 'A'
VS2	.461 [11.70]
VS3	.630 [16.00]

P.C.MOUNTING

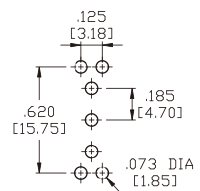

3MN-Series Dimensional Specifications: in. [mm]

Termination Options

VS2-VS3 Double Pole

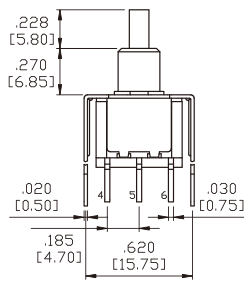
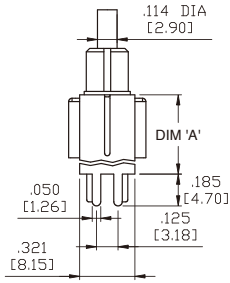

OPTION CODE	DIM.'A'
VS2	.461 [11.70]
VS3	.630 [16.00]

P.C.MOUNTING

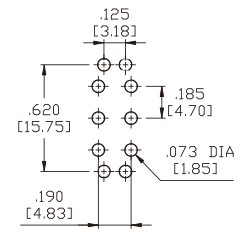

VS4-VS5 Single Pole

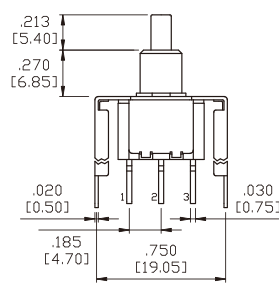
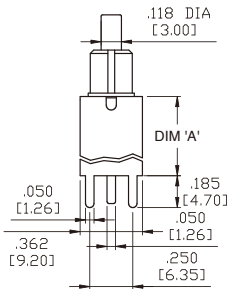

OPTION CODE	DIM.'A'
VS4	.461 [11.70]
VS5	.630 [16.00]

P.C.MOUNTING

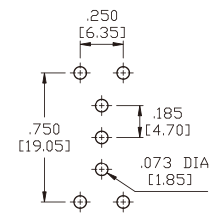

VS4-VS5 Double Pole

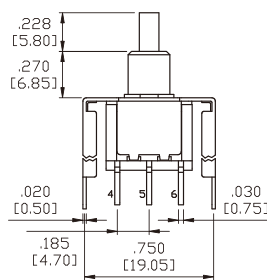
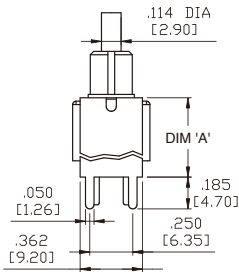

OPTION CODE	DIM.'A'
VS4	.461 [11.70]
VS5	.630 [16.00]

P.C.MOUNTING

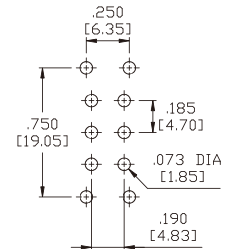

VS6-VS7 Single Pole

(FOR B6 BUSHING ONLY)

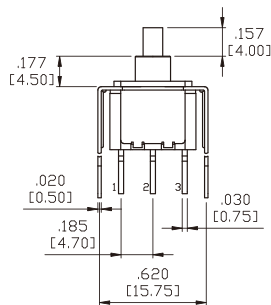
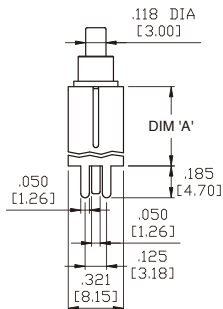

OPTION CODE	DIM.'A'
VS6	.461 [11.70]
VS7	.630 [16.00]

P.C.MOUNTING

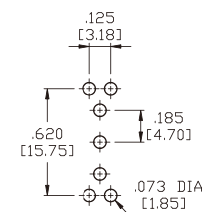

3MN-Series Dimensional Specifications: in. [mm]

Termination Options

VS6-VS7 Double Pole (FOR B6 BUSHING ONLY)

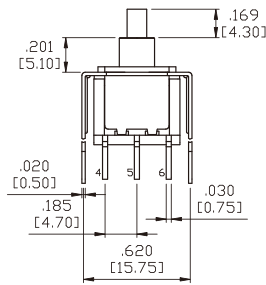
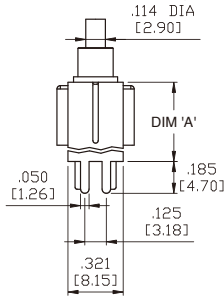

OPTION CODE	DIM: 'A'
VS6	.461 [11.70]
VS7	.630 [16.00]

P.C.MOUNTING

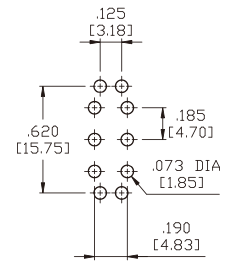

VS8-VS9 Single Pole (FOR B6 BUSHING ONLY)

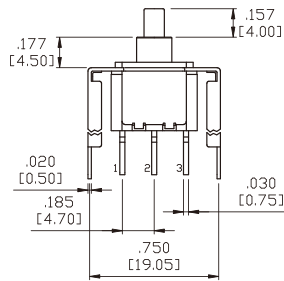
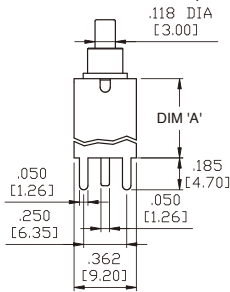

OPTION CODE	DIM: 'A'
VS8	.461 [11.70]
VS9	.630 [16.00]

P.C.MOUNTING

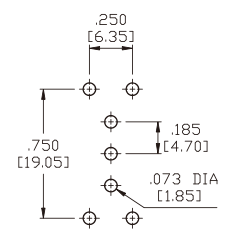

VS8-VS9 Double Pole (FOR B6 BUSHING ONLY)

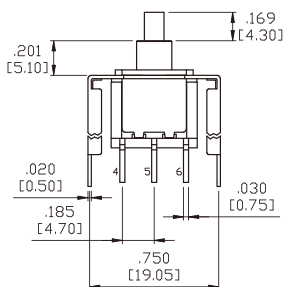
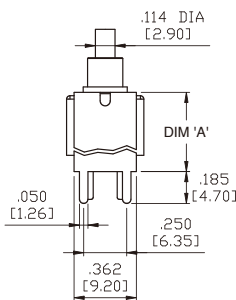

OPTION CODE	DIM: 'A'
VS8	.461 [11.70]
VS9	.630 [16.00]

P.C.MOUNTING

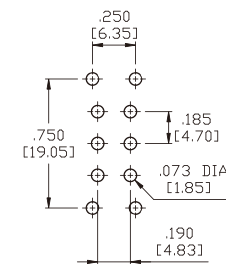

Snap-In Termination Options

VS21, VS31

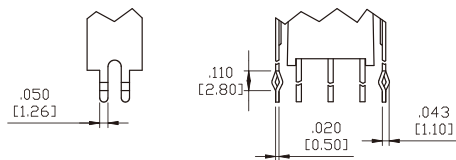

VS41, VS51

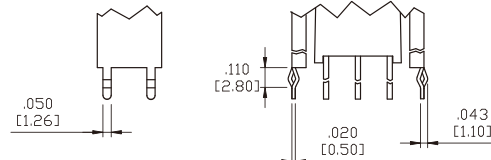

* PC Mounting for VS21, VS31, VS41, VS51 refer to VS2, VS3, VS4, VS5 respectively.

3MA-Series Dimensional Specifications: in. [mm]

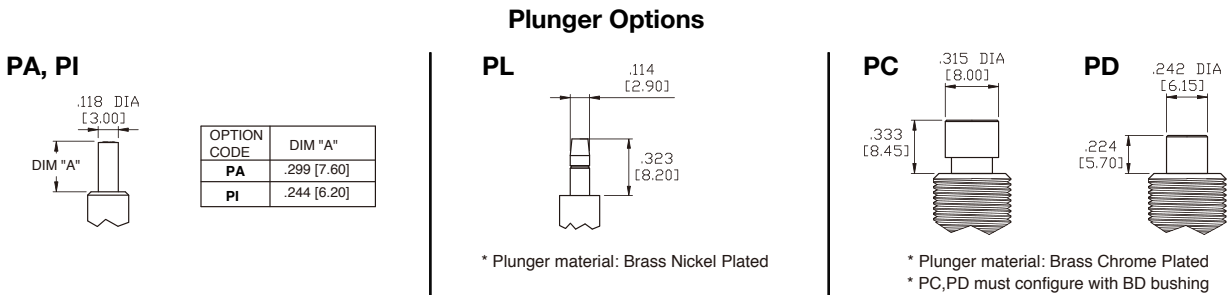
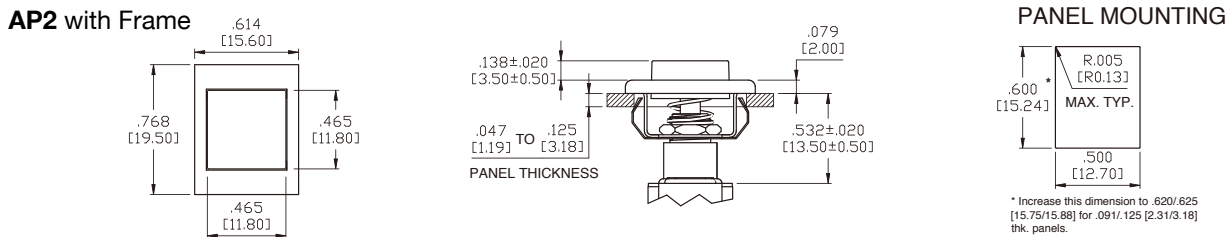
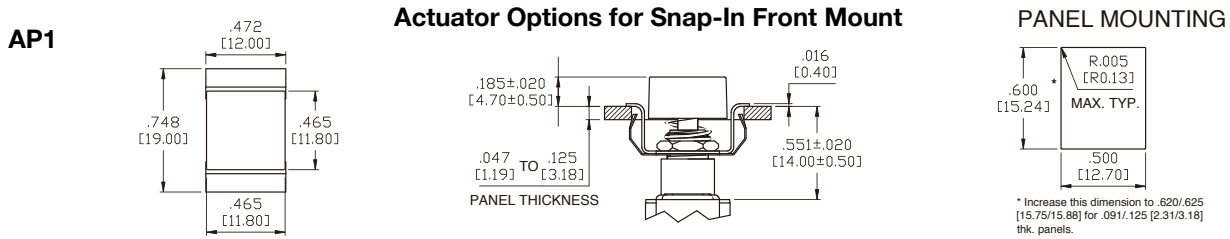
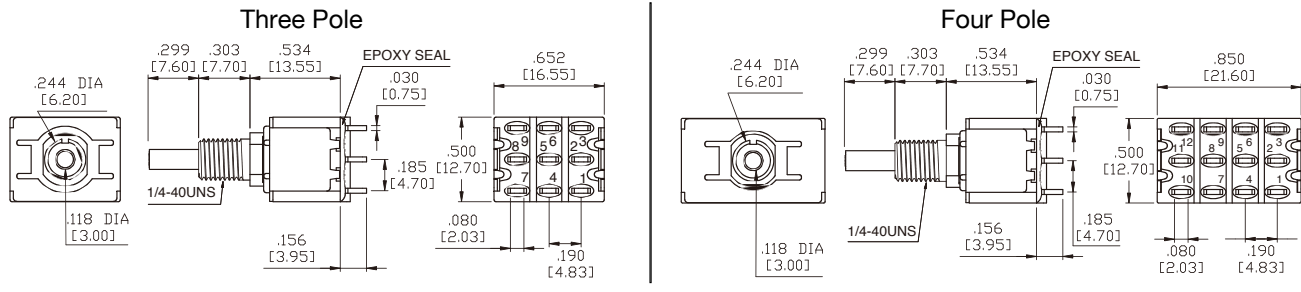
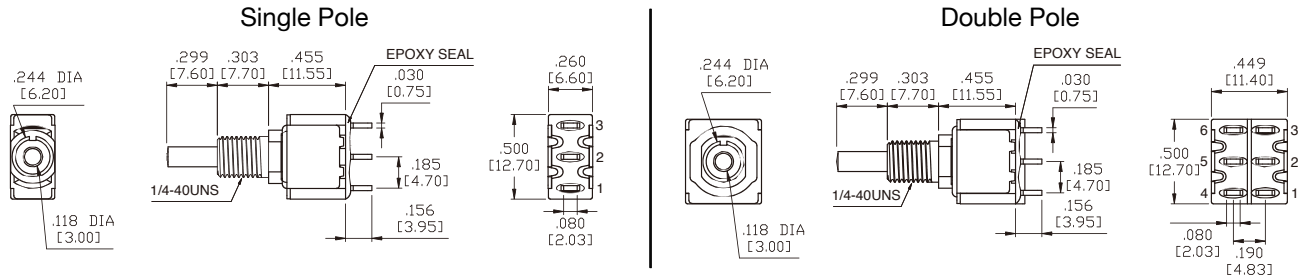

3MA-Series Dimensional Specifications: in. [mm]

B10 Threaded Standard B20 Non-Threaded

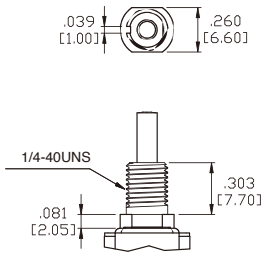

Bushing Options

B21 Non-Threaded

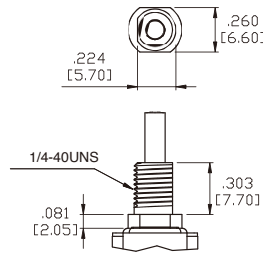

BD Threaded Standard

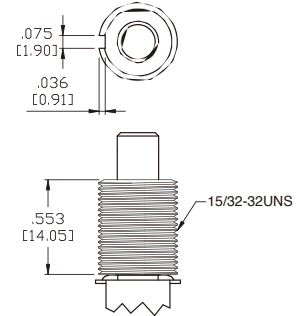

Termination Options

M1 Standard Solder Lug

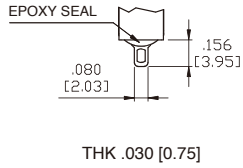

M2 PC Thru-Hole

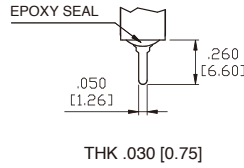

M5 Wire Wrap

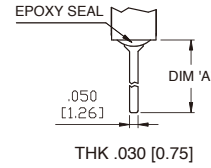

OPTION CODE	DIM. 'A'
M5-1	.750 [19.05]
M5-2	.964 [24.48]
M5-3	.425 [10.80]
M5-4	1.062 [26.97]

M6 Single Pole

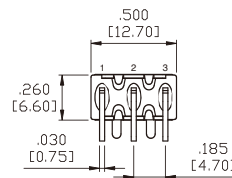
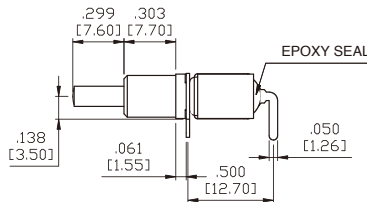
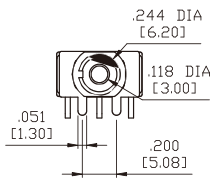

P.C.MOUNTING

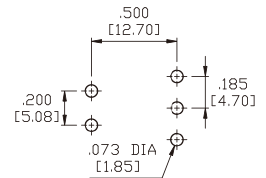

M6 Double Pole

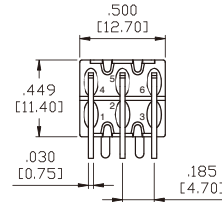
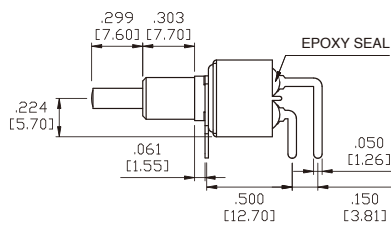
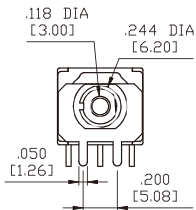

P.C.MOUNTING

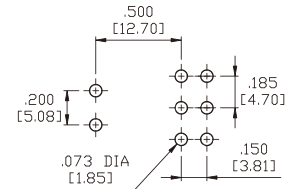

M7 Single Pole

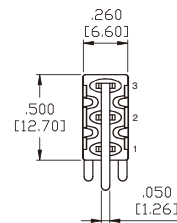
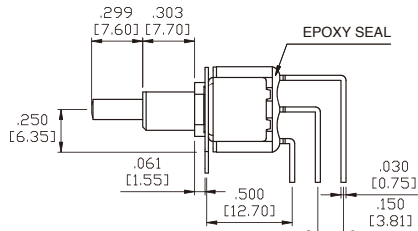
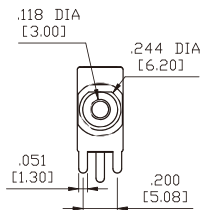

P.C.MOUNTING

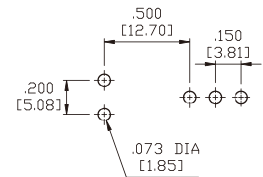

3MA-Series Dimensional Specifications: in. [mm]

Termination Options

M7 Double Pole

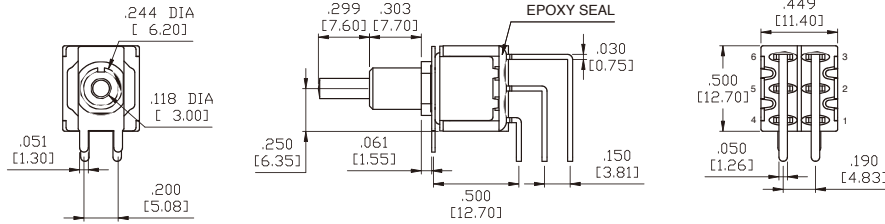

P.C.MOUNTING

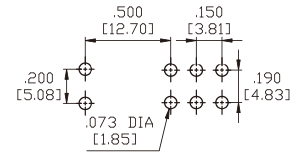

M7 Three Pole

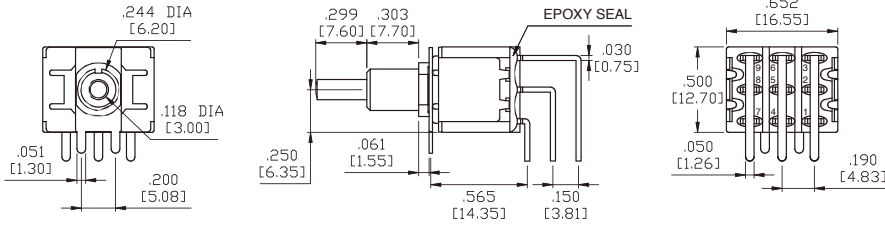

P.C.MOUNTING

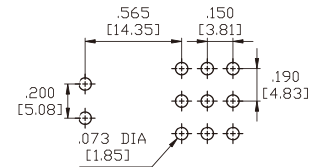

M7 Four Pole

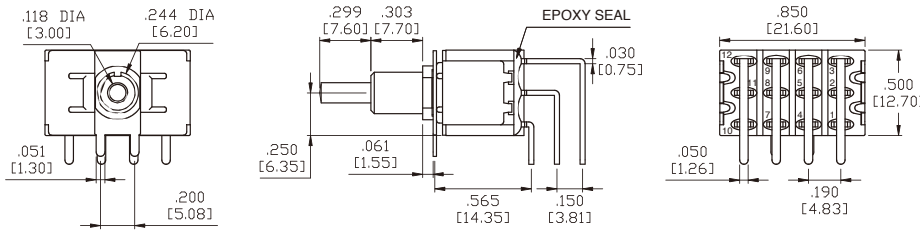

P.C.MOUNTING

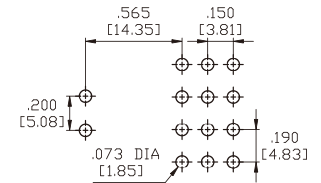

VS2-VS3 Single Pole

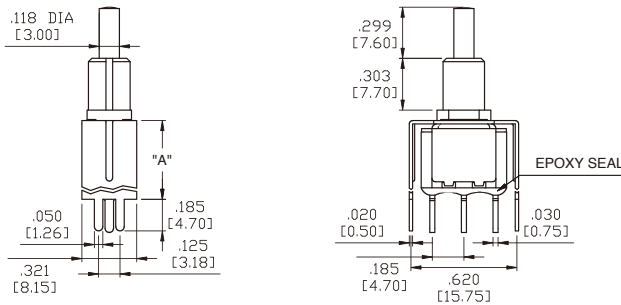

P.C.MOUNTING

OPTION CODE	DIM.'A'
VS2	.461 [11.70]
VS3	.630 [16.00]

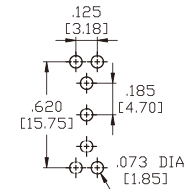

VS2-VS3 Double Pole

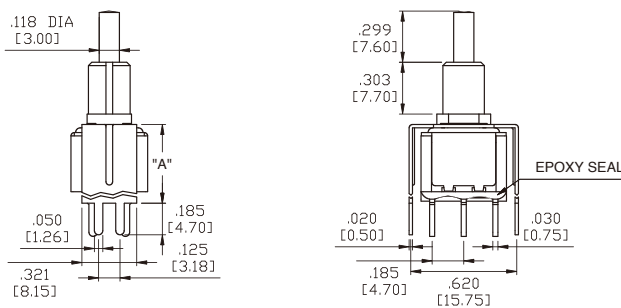

P.C.MOUNTING

OPTION CODE	DIM.'A'
VS2	.461 [11.70]
VS3	.630 [16.00]

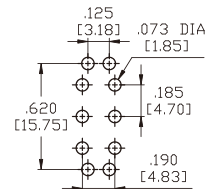

3MA-Series Dimensional Specifications: in. [mm]

Termination Options

VS4-VS5 Single Pole

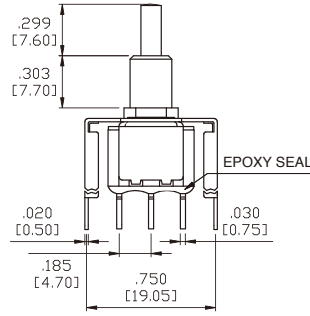
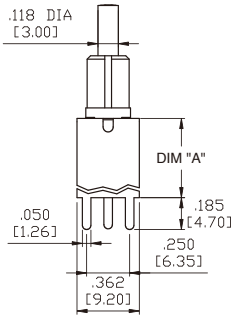

OPTION CODE	DIM.'A'
VS4	.461 [11.70]
VS5	.630 [16.00]

P.C.MOUNTING

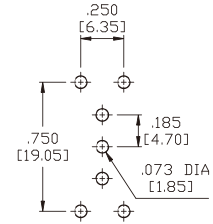

VS4-VS5 Double Pole

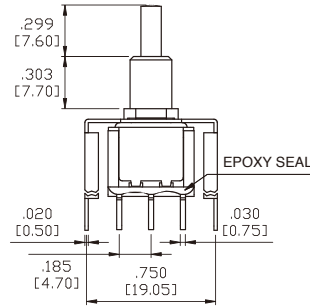
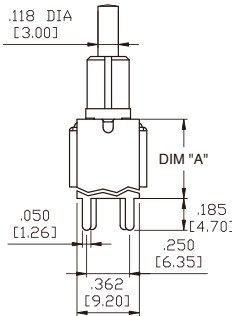

OPTION CODE	DIM.'A'
VS4	.461 [11.70]
VS5	.630 [16.00]

P.C.MOUNTING

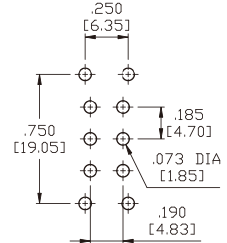

Panel Mounting

1/4 INCH BUSHING

B10

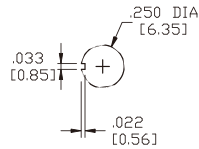

B20

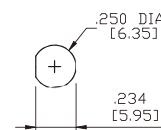

B21

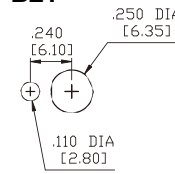

15/32 INCH BUSHING

BD

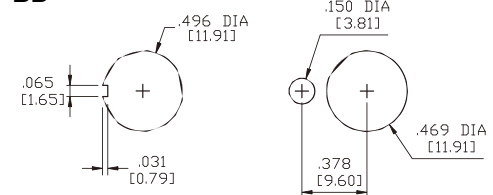

Plunger Caps

C1

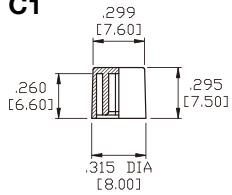

C2

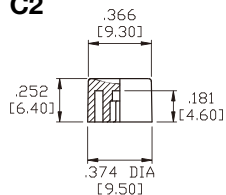

C3

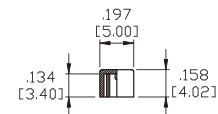
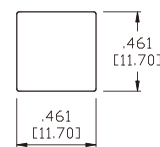

C5

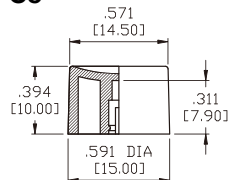

For PL plunger only

C6

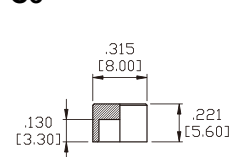

For PD plunger only

C7

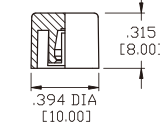

For PL plunger only

CAP AND FRAME COLORS			
1	White	6	Green
2	Black	7	Blue
3	Red	8	Brown
4	Orange	9	Gray
5	Yellow		

MATERIAL: ABS for C1~C5, C7
MATERIAL: Chrome plated brass for C6

Authorized Sales Representatives and Distributors

Click on a region of the map below to find your local representatives and distributors or visit www.carlingtech.com/findarep.



About Carling

Founded in 1920, Carling Technologies is a leading manufacturer of electrical and electronic switches and assemblies, circuit breakers, electronic controls, power distribution units, and multiplexed power distribution systems. With four ISO registered manufacturing facilities and technical sales offices worldwide, Carling Technologies Sales, Service and Engineering teams do much more than manufacture electrical components, they engineer powerful solutions! To learn more about Carling please visit www.carlingtech.com/company-profile.

To view all of Carling's environmental, quality, health & safety certifications please visit www.carlingtech.com/environmental-certifications

Worldwide Headquarters

Carling Technologies, Inc.
60 Johnson Avenue, Plainville, CT 06062
Phone: 860.793.9281 **Fax:** 860.793.9231
Email: sales@carlingtech.com

Northern Region Sales Office: nrsm@carlingtech.com
Southeast Region Sales Office: sersm@carlingtech.com
Midwest Region Sales Office: mrrsm@carlingtech.com
West Region Sales Office: wrsm@carlingtech.com
Latin America Sales Office: larsm@carlingtech.com

Asia-Pacific Headquarters

Carling Technologies, Asia-Pacific Ltd.,
Suite 1607, 16/F Tower 2, The Gateway,
Harbour City, 25 Canton Road,
Tsimshatsui, Kowloon, Hong Kong
Phone: Int + 852-2737-2277 **Fax:** Int + 852-2736-9332
Email: sales@carlingtech.com.hk

Shenzhen, China: shenzhen@carlingtech.com
Shanghai, China: shanghai@carlingtech.com
Pune, India: india@carlingtech.com
Kaohsiung, Taiwan: taiwan@carlingtech.com
Yokohama, Japan: japan@carlingtech.com

Europe | Middle East | Africa Headquarters

Carling Technologies LTD
4 Airport Business Park, Exeter Airport,
Clyst Honiton, Exeter, Devon, EX5 2UL, UK
Phone: Int + 44 1392.364422 **Fax:** Int + 44 1392.364477
Email: ltd.sales@carlingtech.com

Germany: gmbh@carlingtech.com
France: sas@carlingtech.com



Carling Technologies®

Innovative Designs. Powerful Solutions.

X-ON Electronics

Largest Supplier of Electrical and Electronic Components

Click to view similar products for [Pushbutton Switches](#) category:

Click to view products by [Carling](#) manufacturer:

Other Similar products are found below :

[LW1L-M1C10V-A](#) [LW2L-A1C20M-GD](#) [LW2L-M1C20M-A](#) [60324L](#) [M7E-HRN2](#) [67021K512](#) [67081K512X](#) [701PB580](#) [719-5504-000](#)
[MDPSSGLFS](#) [810KSV30B](#) [MML21KA3ABK](#) [MML23KA3AC05K-001](#) [MML23KW3AA01W](#) [8418K2](#) [8646AB6X718UL](#) [8646ABUL](#)
[FSDWH](#) [9001KXRK](#) [9001T8BK](#) [9533CD4+U574+U4922](#) [1203MRA](#) [A22EM01S](#) [A595](#) [1202A6](#) [12037A2ULCSA](#) [1203A2UL](#) [ABD122N-](#)
[B](#) [1211390004](#) [ABN111-Y](#) [ABN400-R](#) [1211500044](#) [1211580012](#) [1212MRA](#) [1232A6NF](#) [RA3CSH6A](#) [1241.1183.7047](#) [1241.2511](#)
[1241.3428](#) [1223A2ULCSA](#) [1223MRA](#) [1232AX2119](#) [1241.1183.8000](#) [1241.1183.8029](#) [1241.2506](#) [1241.2606](#) [12MA6](#) [1301940184](#)
[RELBARF6X10\(PLASTIC\)](#) [13435AG](#)