

# XL-MaxSonar® - WR/WRC™ Series

High Resolution, IP67 Weather Resistant, Ultra Sonic Range Finder

MB7052, MB7060, MB7062, MB7066, MB7067, MB7068,  
MB7070, MB7072, MB7076, MB7077, MB7078, MB7092



The XL-MaxSonar-WR and XL-MaxSonar-WRC sensor series provide users with robust range information in air. These sensors also feature high-power acoustic output along with real-time auto calibration for changing conditions (supply voltage sag, acoustic noise, or electrical noise), operation with supply voltage from 3V to 5.5V, object detection from 0-cm to 765-cm (select models) or 1068-cm (select models), and sonar range information from 20-cm out to 765-cm (select models) or 1068-cm (select models) with 1-cm resolution. Objects from 0-cm to 20-cm range as 20-cm or closer. The sensor is housed in a robust PVC housing, designed to meet the IP67 water intrusion standard, and matches standard electrical/water ¾" PCV pipe fittings. The user interface formats included are pulse-width (select models), real-time analog-voltage envelope (select models), analog voltage output, and serial output.

Features	Benefits	Applications and Uses
<ul style="list-style-type: none"> <li>• Real-time auto calibration and noise rejection</li> <li>• High acoustic power output</li> <li>• Precise narrow beam</li> <li>• Object detection includes zero range objects</li> <li>• 3V to 5.5V supply with very low average current draw</li> <li>• Free run operation can continually measure and output range information</li> <li>• Triggered operation provides the range reading as desired</li> <li>• All interfaces are active simultaneously</li> <li>• RS232 Serial, 0 to Vcc, 9600 Baud, 81N</li> <li>• Analog, (Vcc/1024) / cm for standard models</li> <li>• Analog, (Vcc/1024) / 2cm for 10-meter models (MB7066, MB7076)</li> <li>• Sensor operates at 42KHz</li> </ul>	<ul style="list-style-type: none"> <li>• Acoustic and electrical noise resistance</li> <li>• Reliable and stable range data</li> <li>• Sensor dead zone virtually non-existent</li> <li>• Robust, low cost IP67 standard sensor</li> <li>• Narrow beam characteristics</li> <li>• Very low power excellent for battery based systems</li> <li>• Ranging can be triggered externally or internally</li> <li>• Sensor reports the range reading directly, frees up user processor</li> <li>• Easy hole mounting or mating with standard electrical fittings</li> <li>• Filtering allows very reliable operation in most environments</li> </ul>	<ul style="list-style-type: none"> <li>• Tank level measurement</li> <li>• Bin level measurement</li> <li>• Proximity zone detection</li> <li>• Environments with acoustic and electrical noise</li> <li>• Distance measuring</li> <li>• Long range object detection</li> <li>• Industrial sensor</li> <li>• -40°C to +65°C (limited operation to +85°C)</li> </ul>

## About Ultrasonic Sensors

Our ultrasonic sensors are desired for use in air, non-contact object detection and ranging sensors that detect objects within a defined area. These sensors are not affected by the color or other visual characteristics of the detected object. Ultrasonic sensors use high frequency sound to detect and localize objects in a variety of environments. Ultrasonic sensors measure the time of flight for sound that has been transmitted to and reflected back from nearby objects. Based upon the time of flight, the sensor then outputs a range reading.

## XL-MaxSonar-WR/WRC Pin Out

**Pin 1-** Leave open (or high) for serial output on the Pin 5 output. When Pin 1 is held low the Pin 5 output sends a pulse (instead of serial data), suitable for low noise chaining.

**Pin 2-** This pin outputs a pulse-width representation of range. To calculate the distance, use a scale factor of 58uS per cm. (MB7052, MB7060, MB7062, MB7066, MB7067, MB7068)

This pin outputs the analog voltage envelope of the acoustic waveform. For the MB7070 series and MB7092 sensors, this is a real-time always-active output (MB7070, MB7072, MB7076, MB7077, MB7078, MB7092)

**Pin 3- AN-** This pin outputs analog voltage with a scaling factor of ( $V_{cc}/1024$ ) per cm. A supply of 5V yields  $\sim 4.9\text{mV/cm}$ , and 3.3V yields  $\sim 3.2\text{mV/cm}$ . Hardware limits the maximum reported range on this output to  $\sim 700$  cm at 5V and  $\sim 600$  cm at 3.3V. The output is buffered and corresponds to the most recent range data.

For the 10-meter sensors (MB7066, MB7076) Pin 3 outputs an analog voltage with a scaling of ( $V_{cc}/1024$ ) per 2cm. A supply of 5V yields  $\sim 4.9\text{mV}/2\text{cm}$ , and 3.3V yields  $\sim 3.2\text{mV}/2\text{cm}$ . This Analog Voltage output steps in 2cm increments.

**Pin 4- RX-** This pin is internally pulled high. If Pin-4 is left unconnected or held high, the sensor will continually measure the range. If Pin-4 is held low the sensor will stop ranging. Bring high 20uS or more to command a range reading.

**Pin 5- TX-** When Pin 1 is open or held high, the Pin 5 output delivers asynchronous serial data in an RS232 format, except the voltages are 0-Vcc. The output is an ASCII capital "R", followed by ASCII character digits representing the range in centimeters up to a maximum of 765 (select models) or 1068 (select models), followed by a carriage return (ASCII 13). The baud rate is 9600, 8 bits, no parity, with one stop bit. Although the voltages of 0V to Vcc are outside the RS232 standard, most RS232 devices have sufficient margin to read the 0V to Vcc serial data. If standard voltage level RS232 is desired, invert, and connect an RS232 converter such as a MAX232. When Pin 1 is held low, the Pin 5 output sends a single pulse, suitable for low noise chaining (no serial data).

**V+** Operates on 3V - 5.5V. The average (and peak) current draw for 3.3V operation is 2.1mA (50mA peak) and 5V operation is 3.4mA (100mA peak) respectively. Peak current is used during sonar pulse transmit.

**GND-** Return for the DC power supply. GND (& V+) must be ripple and noise free for best operation.

## Auto Calibration

Each time before the XL-MaxSonar-WR takes a range reading it auto calibrates. The sensor then uses this data to range objects. If the temperature, humidity, or applied voltage changes during sensor operation, the sensor will continue to function normally. (The sensors do not apply compensation for the speed of sound change verses temperature to any range readings.) If the application requires temperature compensation please look at the HRXL-MaxSonar-WR sensor line.

## Supply Voltage Compensation

During power up, the XL-MaxSonar-WR sensor line will calibrate itself for the supply voltage. Additionally, the sensor will compensate if the supplied voltage gradually changes.

If the average voltage applied to the sensor changes faster than 0.5V per second, it is best to remove and reapply power to the sensor.

For best operation, the sensor requires noise free power. If the sensor is used with noise on the supplied power or ground, the accuracy of the readings may be affected. Typically, adding a 100uF capacitor at the sensor between the V+ and GND pins will correct most power related electrical noise issues.

## XL-MaxSonar-WR Mechanical Dimensions

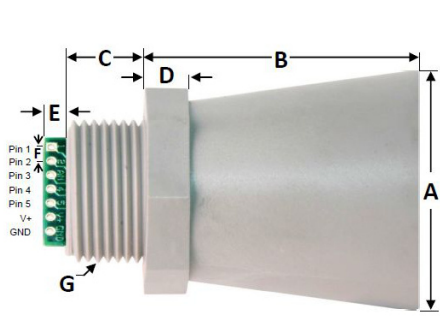

Values Are Nominal

A	1.72" dia.	43.8 mm dia.
B	2.00"	50.7 mm
C	0.58"	14.4 mm
D	0.31"	7.9 mm
E	0.23"	5.8 mm
F	0.1"	2.54 mm
G	3/4" - 14 National Pipe Thread Straight	
H	1.032" dia.	26.2 mm dia.
I	1.37"	34.8 mm
Weight		50 grams

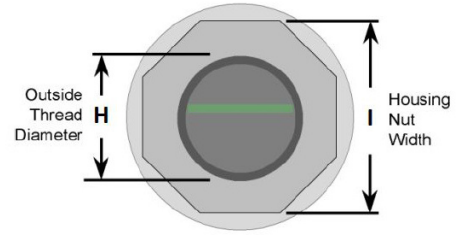

## XL-MaxSonar-WRC Mechanical Dimensions

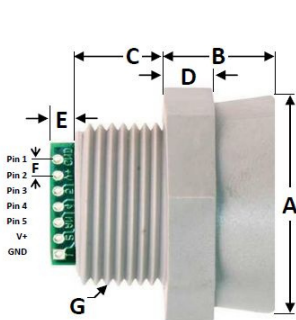

Values Are Nominal

A	34.7 mm dia.	1.37" dia.
B	17.9 mm	0.700"
C	14.4 mm	0.570"
D	7.9 mm	0.310"
E	5.8 mm	0.230"
F	2.54 mm	0.100"
G	3/4" - 14 National Pipe Thread Straight	
H	26.2 mm dia.	1.032" dia.
I	34.8 mm	1.370"
Weight		32 grams

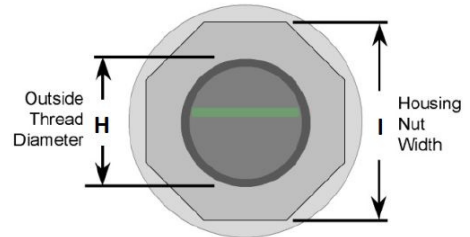

## Range "0" Location

The XL-MaxSonar-WR and XL-MaxSonar-WRC reports the range to distant targets starting from the front of the transducer as shown in the diagram below.

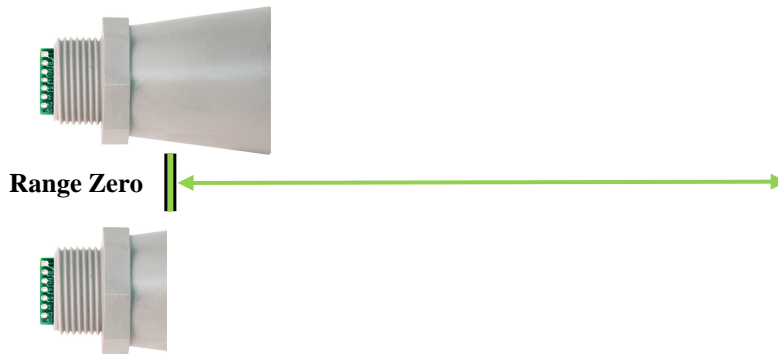

The range is measured from the front of the transducer.

## **Base Sensor (MB7060 and MB7070)**

The MB7060 and MB7070 are the base models of the XL-MaxSonar-WR sensor line. These sensors are recommended for general purpose usage. All other sensors in this series are based off these sensor models. The additional features are mentioned in their respective sections below.

---

## **XL-MaxSonar-WR1 (MB7062 and MB7072)**

The XL-MaxSonar-WR1 sensors feature a 3 reading stability filter that ranges to the first detectable target. This filter requires that 3 consecutive range readings are within 10cm of each other to be considered a valid range reading. If the range readings are outside 10cm, the sensor discards the range reading set and reports the last valid range reading. This sensor does not view maximum range as a valid range, and will not report 765 when no target is detected. If this sensor does not detect a target for 1 hour, the sensor will go into fail-safe and report 000.

---

## **XL-MaxSonar-WRL (MB7066 and MB7076)**

The XL-MaxSonar-WRL will report a maximum distance of 10 meters for large targets.

---

## **XL-MaxSonar-WRM (MB7052 and MB7092)**

The XL-MaxSonar-WRM sensors are equipped with filtering firmware that allows the sensor to ignore smaller targets and noise, and still report the target that gives the largest acoustic reflection. This sensor will also reject infrequent and random noise, even if the noise has a higher amplitude than the acoustic return from the target. If the largest target is removed from the field of view, the XL-MaxSonar-WRM will switch to the target that gives the next largest detectable return.

The XL-MaxSonar-WR sensors were designed for applications where users are concerned with ranging the distance to flat targets (such as water and fuel tanks). This filtering algorithm stands in contrast to the other XL-MaxSonar-WR sensors that are designed to report the distance to the first detectable target.

In general, the XL-MaxSonar-WR will select the largest target from its field of view and report its range. Even so, objects up close may provide significantly greater returns over distant objects. Users are encouraged to test the sensor in their application to verify usability.

When targets are of similar amplitude reflections, preference is given to the closest target.

---

## **XL-MaxSonar-WRC (MB7067 and MB7077)**

The XL-MaxSonar-WRC sensors are the compact version of the MB7060 and MB7070. These sensors have a maximum detection range of 645 cm, and will report 765 cm when there are not targets detectable. If size is a concern in your application, you may want to consider the MB72XX sensors at <http://www.maxbotix.com/WRUC>.

---

## **XL-MaxSonar-WRC1 (MB7068 and MB7078)**

The XL-MaxSonar-WRC1 sensors are the compact version of the MB7062 and MB7072. These sensors have a maximum detection range of 645 cm. If size is a concern in your application, you may want to consider the MB72XX sensors at <http://www.maxbotix.com/WRUC>.

---

## **Sensor Minimum Distance - No Sensor Dead Zone**

The XL-MaxSonar-WR sensors have a minimum reported distance of 20-cm (7.87 inches). However, the XL-MaxSonar-WR will range and report targets to the front sensor face. Large targets closer than 20-cm will typically range as 20-cm. For the XL-MaxSonar-WRC, objects between 3-cm and 20-cm will typically range as 20-cm.

## Typical Performance to Target

### All sensor models

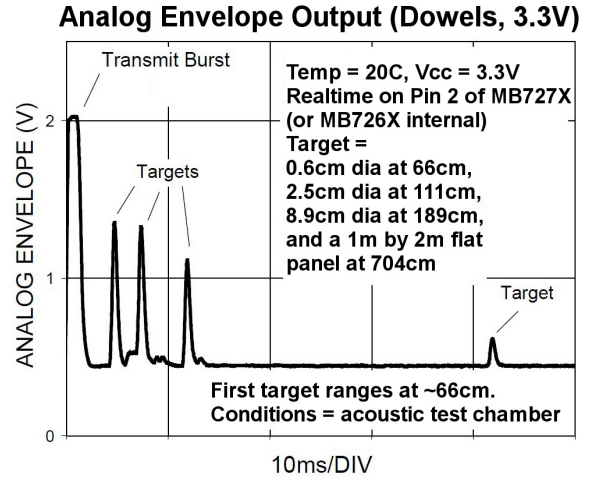
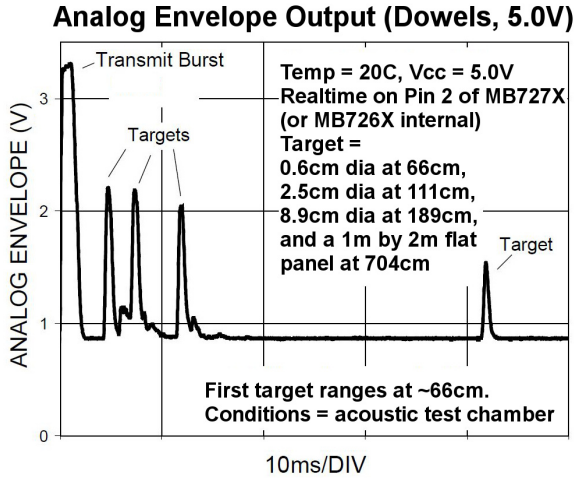

## Typical Performance in Clutter

### MB7060, MB7062, MB7076, MB7067, MB7068, MB7070, MB7072, MB7076, MB7077, MB7078

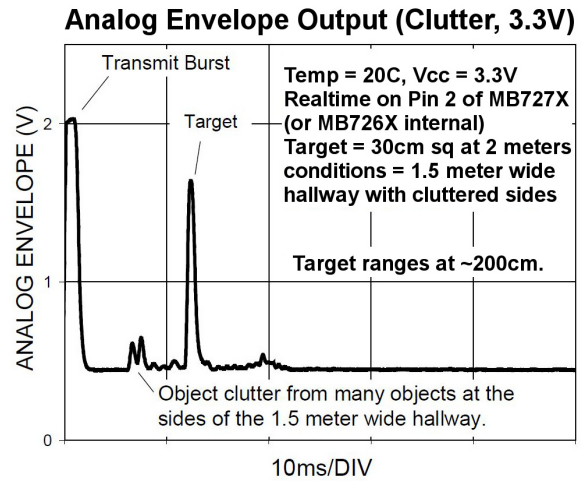
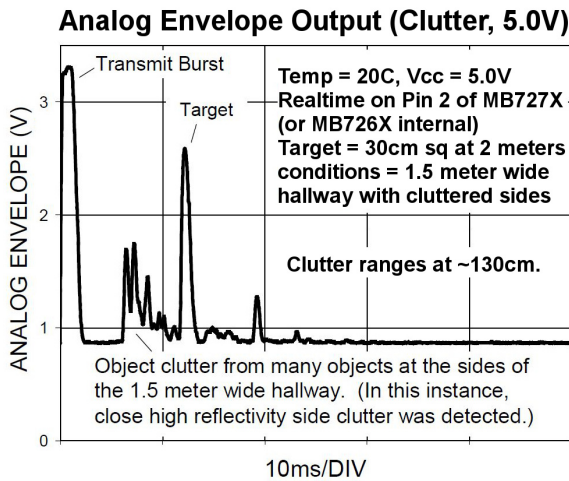

## Typical Performance in Clutter

### MB7052, MB7092

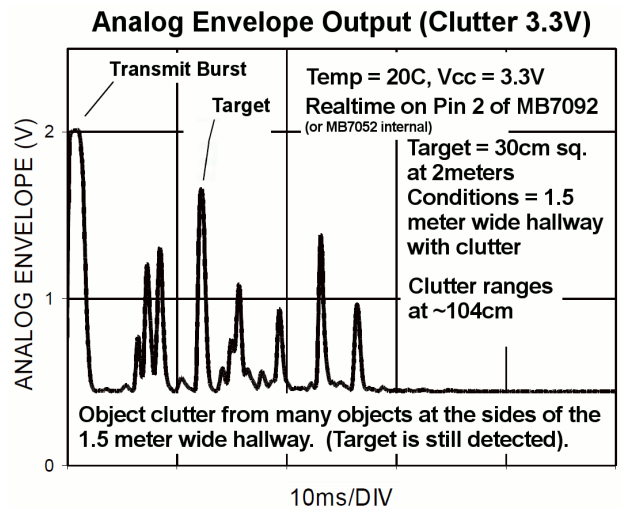
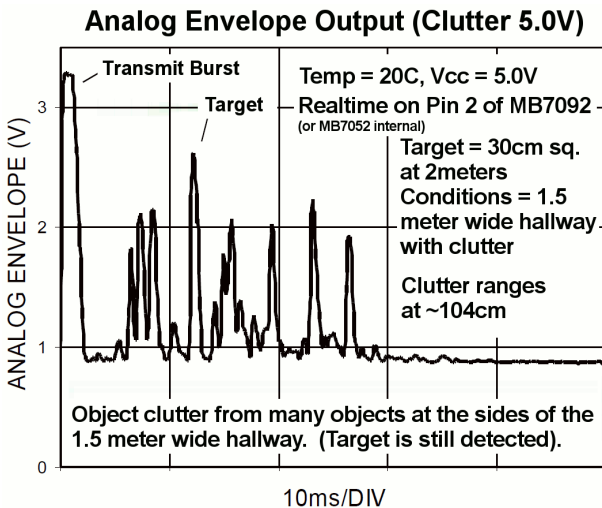

## Device Comparison Chart

Part Number	AN Voltage	Serial Data (0 to Vcc level)	Pulse Width	Analog Envelope	Stability Filter	Most Likely Filter	Compact	7 meter range	10 meter range
MB7052	Yes	RS232	Yes		Yes	Yes		Yes	
MB7060	Yes	RS232	Yes					Yes	
MB7062	Yes	RS232	Yes		Yes			Yes	
MB7066	Yes	RS232	Yes						Yes
MB7067	Yes	RS232	Yes				Yes	Yes	
MB7068	Yes	RS232	Yes		Yes		Yes	Yes	
MB7070	Yes	RS232		Yes				Yes	
MB7072	Yes	RS232		Yes	Yes			Yes	
MB7076	Yes	RS232		Yes					Yes
MB7077	Yes	RS232		Yes			Yes	Yes	
MB7078	Yes	RS232		Yes	Yes		Yes	Yes	
MB7092	Yes	RS232		Yes	Yes	Yes		Yes	

### Real-time Auto Calibration

The XL-MaxSonar-WR automatically calibrates prior to each range reading. The sensor then uses this data to range objects. If the temperature, humidity, or applied voltage changes during sensor operation, the sensor will continue to function normally. (The sensors do not apply compensation for the speed of sound change verses temperature to any range readings.) Detection has been characterized in the published sensor beam patterns.

### Real-time Noise Rejection

While the XL-MaxSonar-WR is designed to operate in the presence of noise, best operation is obtained when noise strength is low and desired signal strength is high. Hence, the user is encouraged to mount the sensor in such a way that minimizes outside acoustic noise pickup. In addition, keep the DC power to the sensor free of noise. This will let the sensor deal with noise issues outside of the users direct control (Even so, in general, the sensor will still function well even if these things are ignored). Users are encouraged to test the sensor in their application to verify usability.

## XL-MaxSonar-WR Sensor Operating Modes

### Independent Sensor Operation

The XL-MaxSonar-WR sensors are designed to operate in a single sensor environment. Free-run is the default mode of operation for all of the MaxBotix Inc., sensors. The XL-MaxSonar-WR sensors have three separate outputs that update the range data simultaneously: Analog Voltage, Pulse Width<sup>1</sup>, and RS232 Serial. Below are diagrams on how to connect the sensor for each of the three outputs. Note 1 - select models output an Analog Envelope for end user processing (MB707X sensors and MB7092)

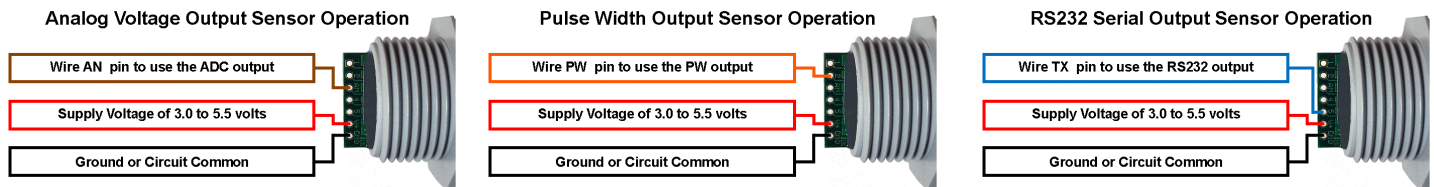

## Using Multiple Sensors in a Single System

When using multiple ultrasonic sensors in a single system, there can be interference (cross-talk) from the other sensors. MaxBotix Inc., has engineered a solution to this problem for the XL-MaxSonar-WR sensors. The solution is referred to as chaining. We have 3 methods of chaining that work well to avoid the issue of cross-talk.

The first method is AN Output Commanded Loop. The first sensor will range, then trigger the next sensor to range and so on for all the sensors in the array. Once the last sensor has ranged, the array stops until the first sensor is triggered to range again. Below is a diagram on how to set this up.

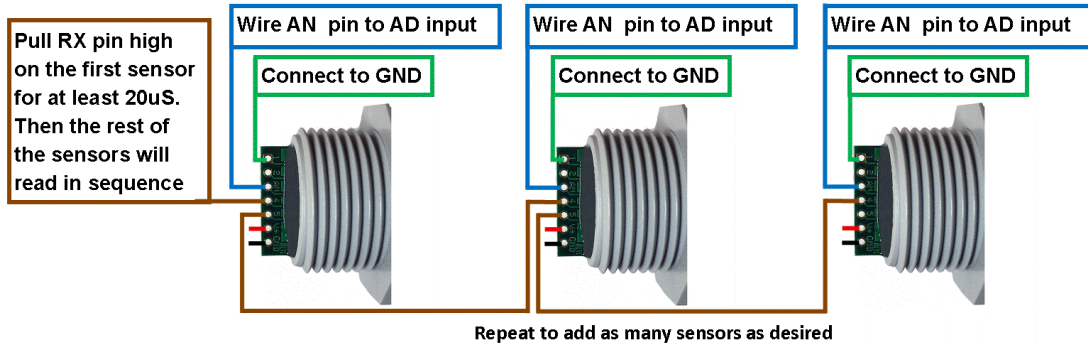

The next method is AN Output Constantly Looping. The first sensor will range, then trigger the next sensor to range and so on for all the sensor in the array. Once the last sensor has ranged, it will trigger the first sensor in the array to range again and will continue this loop indefinitely. Below is a diagram on how to set this up.

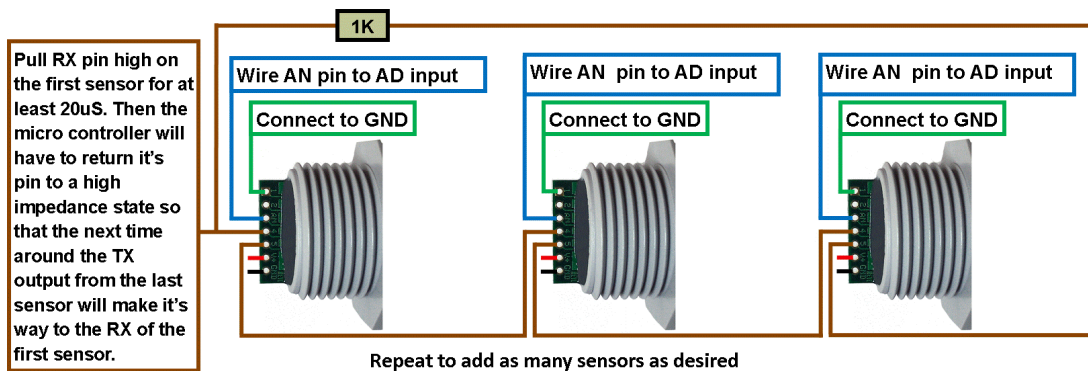

The final method is AN Output Simultaneous Operation. This method does not work in all applications and is sensitive to how the other sensors in the array are physically positioned in comparison to each other. Testing is recommend to verify this method will work for your application. All the sensors RX pins are connected together and triggered at the same time causing all the sensor to take a range reading at the same time. Once the range reading is complete, the sensors stop ranging until triggered next time. Below is a diagram on how to set this up.

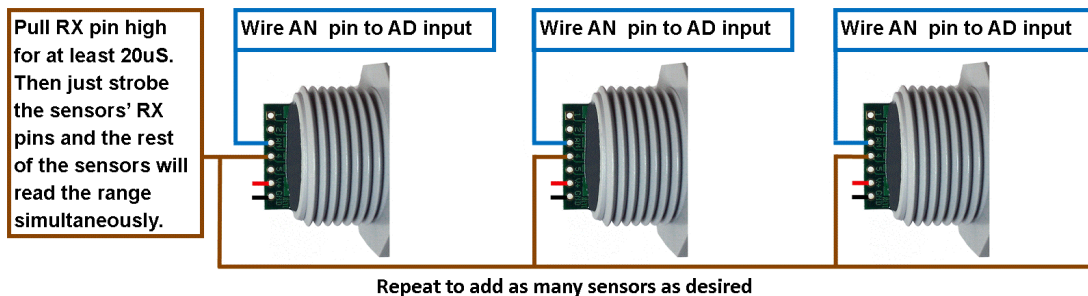

## Sensor Timing Diagrams

### Power-Up Timing

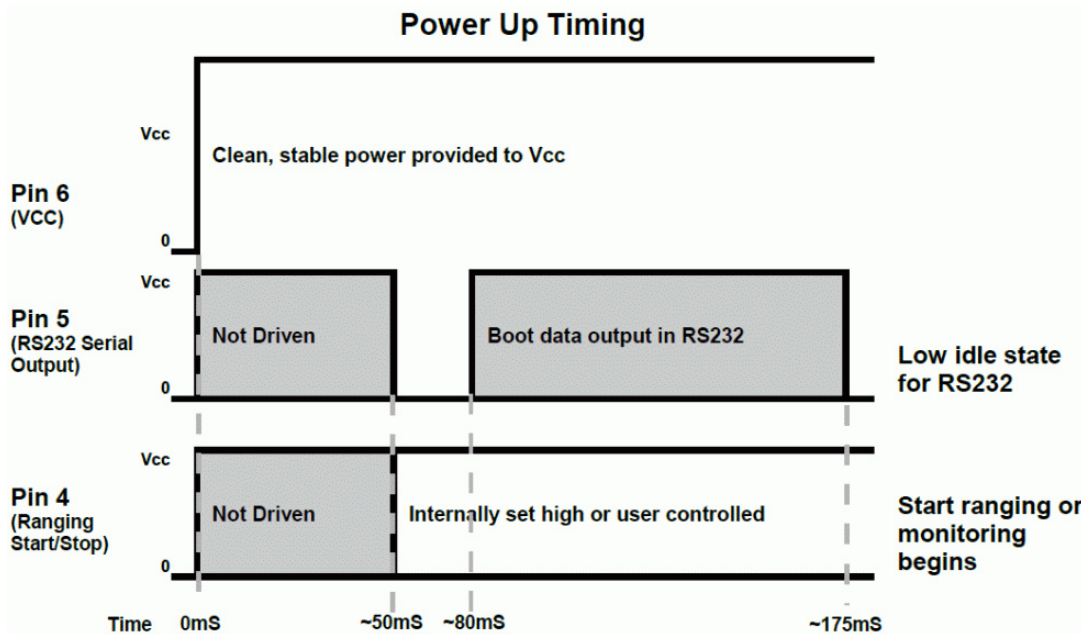

### Sensor Free-Run Timing

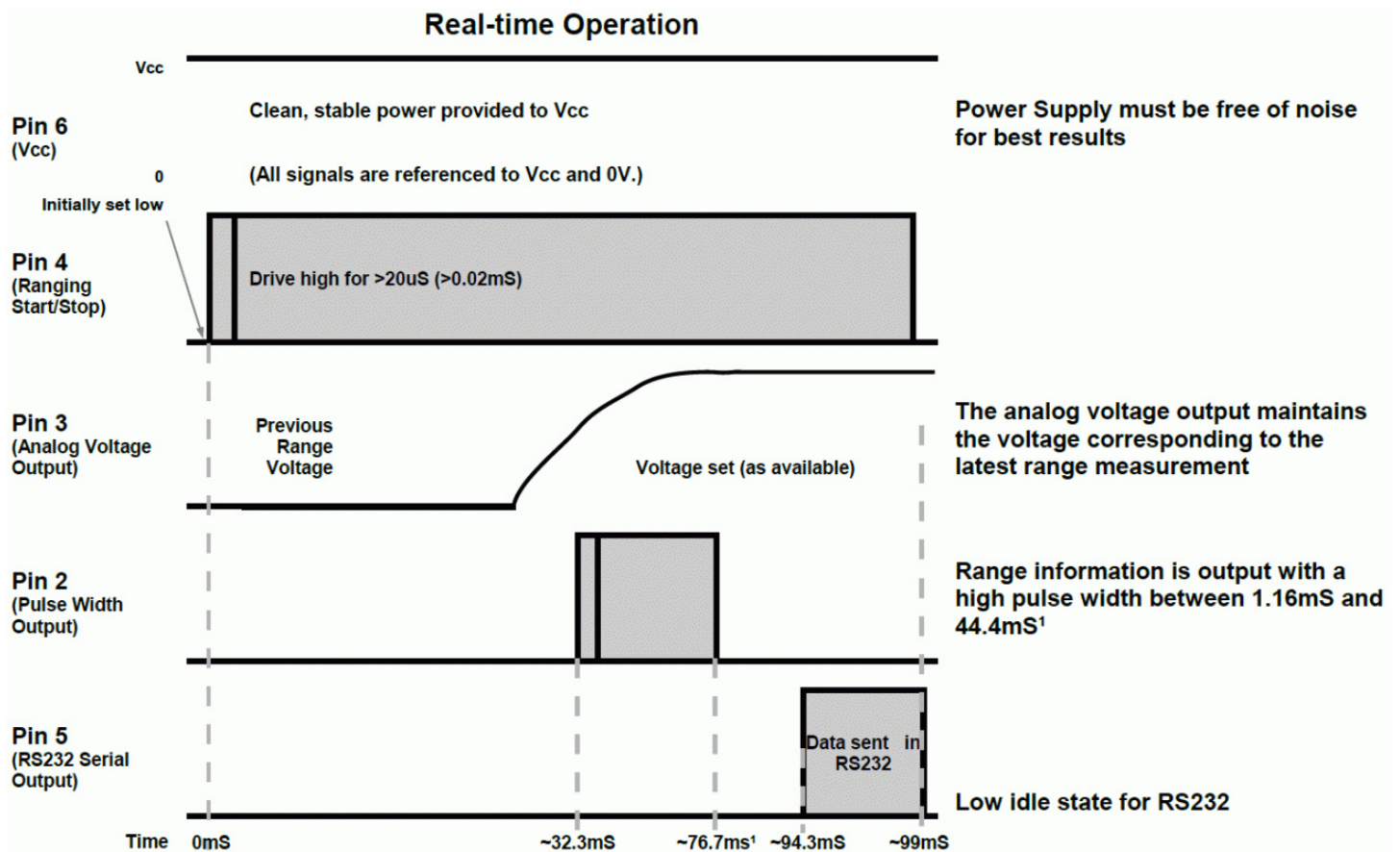



Real-Time Operation

Free-Run Operation

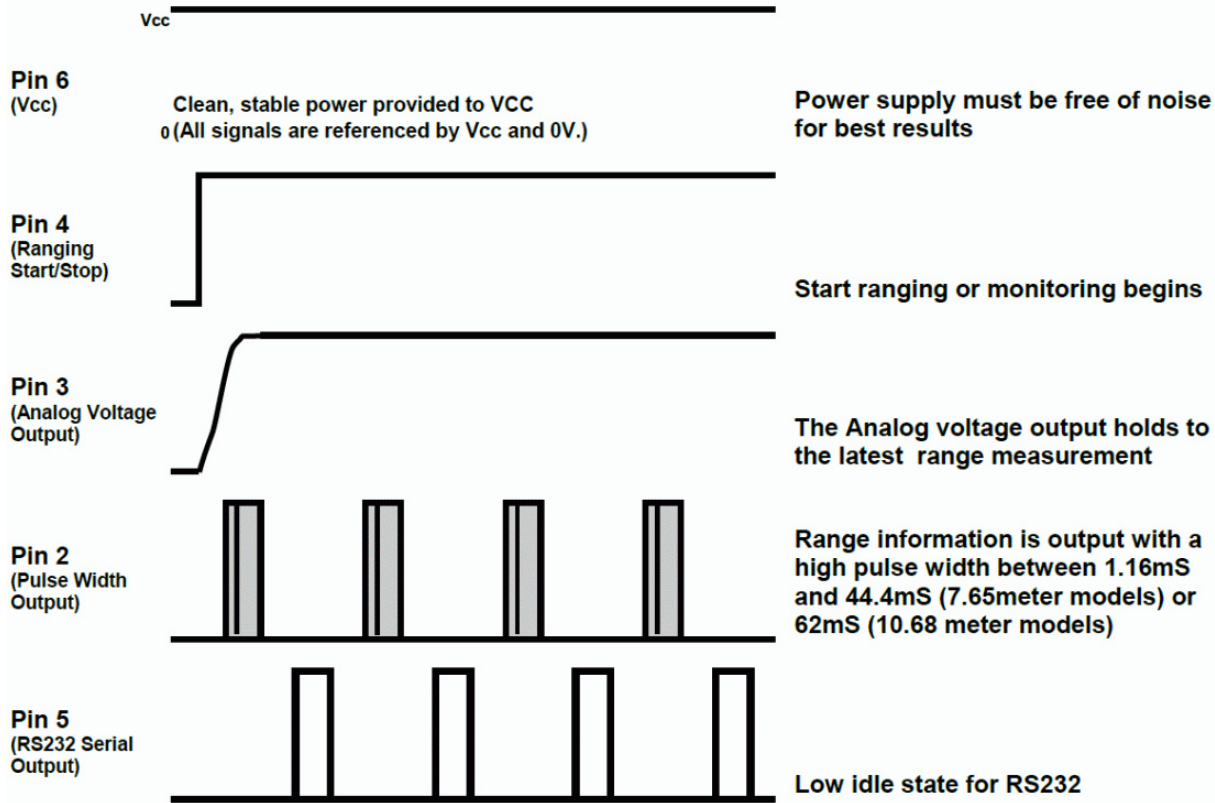

XL-MaxSonar-WR Timing Description

175mS after power-up, the XL-MaxSonar-WR is ready to begin ranging. If Pin-4 is left open or held high (20uS or greater), the sensor will take a range reading. The XL-MaxSonar-WR checks Pin-4 at the end of every cycle. Range data can be acquired once every 99mS. Each 99mS period starts by Pin-4 being high or open, after which the XL-MaxSonar-WR calibrates and calculates for 20.5mS, and after which, thirteen 42KHz waves are sent. The sensor then determines the range to the target. Next the analog voltage is set. At 32.3mS, the sensors with a pulse width (PW), Pin 2 is set high for a length of time between 1.16mS and 44.4mS<sup>1</sup>. At 94.3mS, for the next 4.7mS the serial data is sent. The most accurate range output on the XL-MaxSonar-WR sensors is the PW output. Note 1: for 10-meter sensors, this time is 61.95mS. Then sensors with the analog envelope output (MB7070 series and MB7092), Pin-2 will show the real-time signal return information of the Analog Waveform.

## Background Information Regarding our Beam Patterns

Each XL-MaxSonar-WR sensor has an individually calibrated beam pattern, and is matched to provide the approximate detection pattern shown in this datasheet. This allows end users to select the part number that matches their given sensing application. Each part number has a consistent field of detection so additional units of the same part number will have similar beam patterns. The beam plots are provided to help identify an estimated detection zone for an application based on the acoustic properties of a target versus the plotted beam patterns.

Each beam pattern is a 2D representation of the detection area of the sensor. The beam pattern is actually shaped like a 3D cone (having the same detection pattern both vertically and horizontally). Detection patterns for dowels are used to show the beam pattern of each sensor. Dowels are long cylindered targets of a given diameter. The dowels provide consistent target detection characteristics for a given size target which allows easy comparison of one MaxSonar sensor to another MaxSonar sensor.

For each part number, the four patterns (A, B, C, and D) represent the detection zone for a given target size. Each beam pattern shown is determined by the sensor's part number and target size.

The actual beam angle changes over the full range. Use the beam pattern for a specific target at any given distance to calculate the beam angle for that target at the specific distance. Generally, smaller targets are detected over a narrower beam angle and a shorter distance. Larger targets are detected over a wider beam angle and a longer range.

**People Sensing:**  
For users that desire to detect people, the detection area to the 1-inch diameter dowel, in general, represents the area that the sensor will reliably detect people.

# MB7052-MB7092 XL-MaxSonar® -WRM1/WRMA1™ Beam Pattern and Uses

The XL-MaxSonar-WRM1/WRMA1 ignores smaller targets and only reports the range to the largest acoustic return. The filtering in the MB7052 and MB7092 also rejects moving target clutter such as rain or snow, electrical noise, and outside acoustic noise.

## MB7052-MB7092

### XL-MaxSonar® -WRM/WRM1™ Beam Pattern

Sample results for measured beam pattern are shown on a 30-cm grid. The detection pattern is shown for dowels of varying diameters that are placed in front of the sensor

**A** 6.1-mm (0.25-inch) diameter dowel

**B** 2.54-cm (1-inch) diameter dowel

**C** 8.89-cm (3.5-inch) diameter dowel

**D** 11-inch wide board moved left to right with the board parallel to the front sensor face.

This shows the sensor's range capability.

**Note:** For people detection the pattern typically falls between charts A and B.

■ ■ Partial Detection

— 5.0 V

● 3.3 V

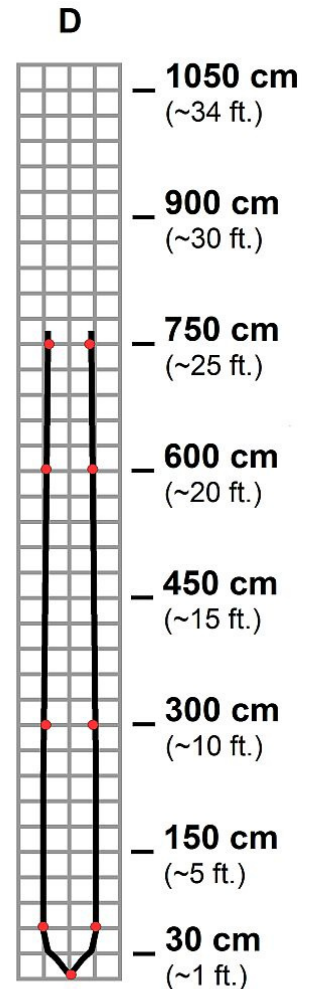
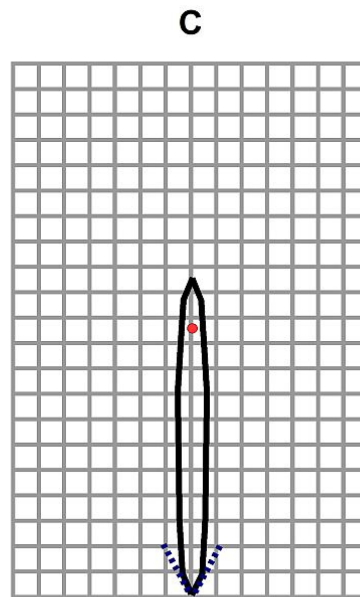
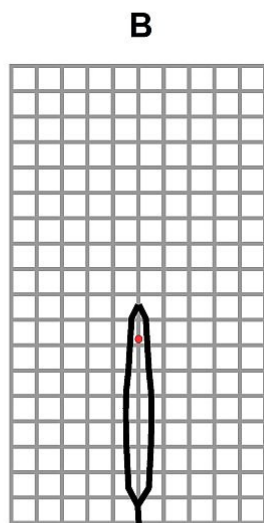
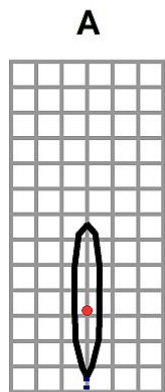

**Beam Characteristics are Approximate**

Beam Pattern drawn to a 1:95 scale for easy comparison to our other products.

### MB7052-MB7092

#### Features and Benefits

- Clutter rejection provides range to the largest amplitude reflection within the field of view
- Real-time calibration, noise rejection and additional filtering provides stable range information
- Excellent for ranging to large objects in the presence of cluttered or noisy environments
- Excellent for applications that require consistently accurate outputs

- Impressive acoustic and electrical noise resistance
- 10Hz refresh rate for the MB7092
- 7.5Hz refresh rate on the MB7052

### MB7052-MB7092

#### Applications and Uses

- Autonomous Navigation
- Environments with acoustic and electrical noise
- Bin Level Measurement
- Tank Level Measurement

# MB7060-MB7070 XL-MaxSonar® -WR/WRA1™ Beam Pattern and Uses

The XL-MaxSonar-WR/WRA1 reports the range to the first detectable target. The MB7060 and MB7070 sensors are the most recommended XL-MaxSonar-WR sensor. This is a good starting place when unsure of which XL-MaxSonar-WR to use.

## MB7060-MB7070

### XL-MaxSonar® -WR/WRA1™ Beam Pattern

Sample results for measured beam pattern are shown on a 30-cm grid. The detection pattern is shown for dowels of varying diameters that are placed in front of the sensor

- A 6.1-mm (0.25-inch) diameter dowel
- B 2.54-cm (1-inch) diameter dowel
- C 8.89-cm (3.5-inch) diameter dowel

D 11-inch wide board moved left to right with the board parallel to the front sensor face. This shows the sensor's range capability.

**Note:** For people detection the pattern typically falls between charts A and B.

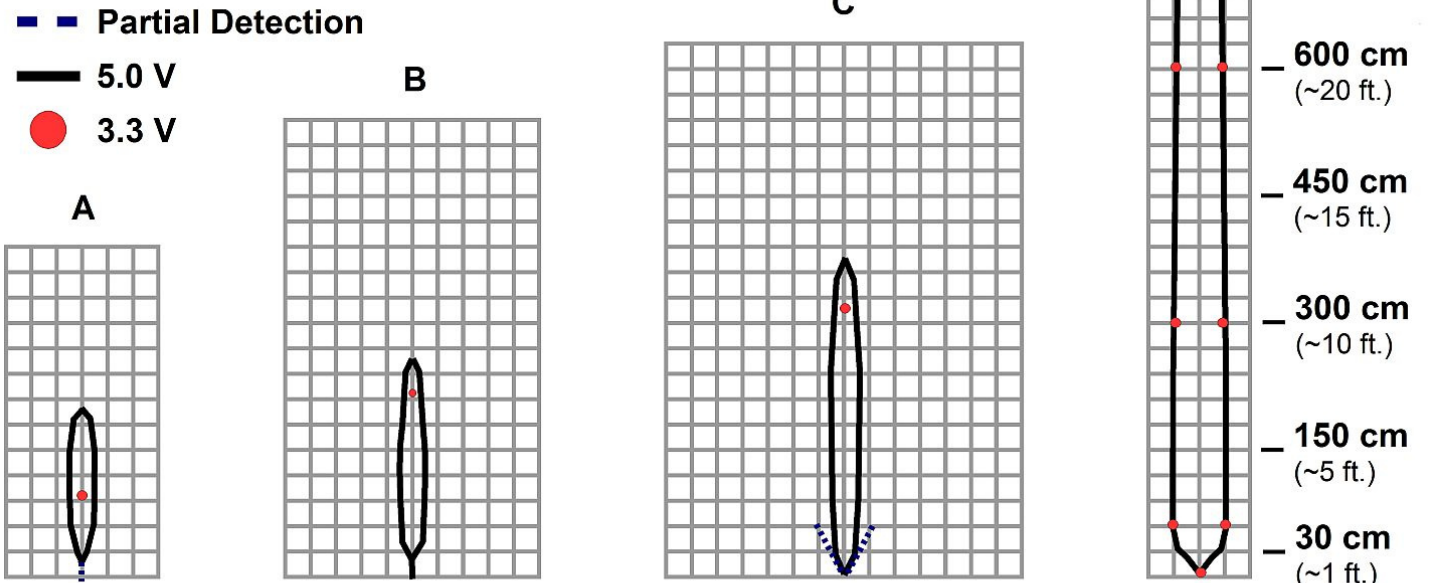

**Beam Characteristics are Approximate**

Beam Pattern drawn to a 1:95 scale for easy comparison to our other products.

### MB7060-MB7070

#### Features and Benefits

- Real-time calibration, and noise rejection for every ranging cycle
- Readings can occur up to every 100mS (10Hz)
- Analog voltage (Vcc/1024) / cm
- Precise narrow beam
- Continuously variable gain

### MB7060-MB7070

#### Applications and Uses

- Applications where a stability filter is not needed or desired
- Multi-Sensor Arrays
- Distance Measuring
- People Detection

# MB7062-MB7072 XL-MaxSonar® -WR/WRA™ Beam Pattern and Uses

The XL-MaxSonar-WR/WRA sensors have a 3 reading stability filter in the firmware. This sensor is well suited for applications requiring stable, accurate range readings. This sensor ranges to the first detectable target.

## MB7062-MB7072

### XL-MaxSonar® -WR™ Beam Pattern

Sample results for measured beam pattern are shown on a 30-cm grid. The detection pattern is shown for dowels of varying diameters that are placed in front of the sensor

**A** 6.1-mm (0.25-inch) diameter dowel

**B** 2.54-cm (1-inch) diameter dowel

**C** 8.89-cm (3.5-inch) diameter dowel

**D** 11-inch wide board moved left to right with the board parallel to the front sensor face.

This shows the sensor's range capability.

**Note:** For people detection the pattern typically falls between charts A and B.

■ Partial Detection

— 5.0 V

● 3.3 V

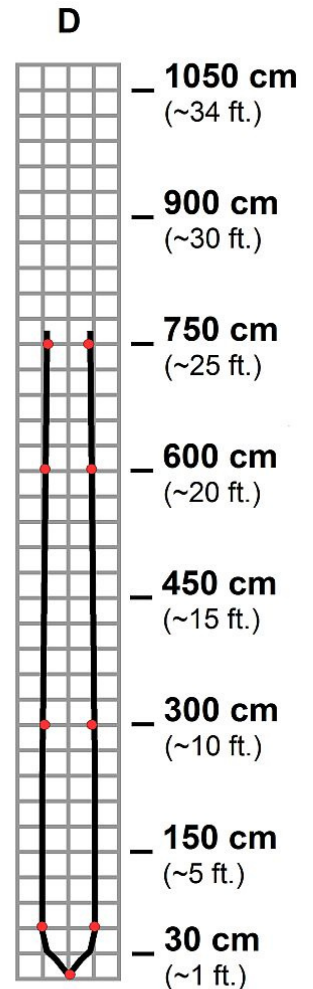
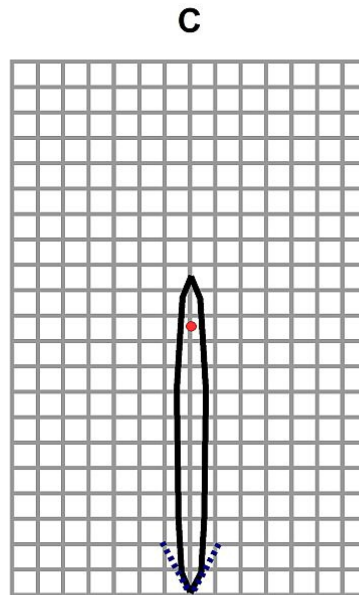
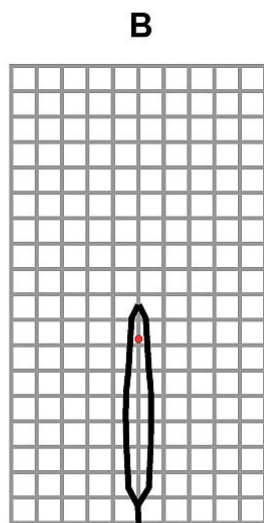
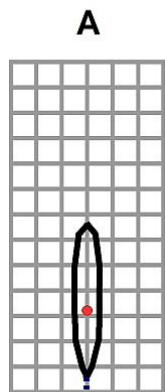

**Beam Characteristics are Approximate**

Beam Pattern drawn to a 1:95 scale for easy comparison to our other products.

### MB7062-MB7072

#### Features and Benefits

- 1 hour fail-safe built into sensor
- Real-time calibration, noise rejection and additional filtering provides stable range information
- Excellent for ranging to large objects in the presence of cluttered or noisy environments
- Excellent for applications that require consistently accurate outputs
- Advanced acoustic and electrical noise filtered output

- Reports filtered output on serial and analog-voltage outputs
- Reliable stable range data
- No power up calibration is required

### MB7062-MB7072

#### Applications and Uses

- Long range object detection
- Industrial sensor
- Drop in upgrade for MB7060 and MB7070

# MB7066-MB7076 XL-MaxSonar®-WRL/WRLA1™ Beam Pattern and Uses

The XL-MaxSonar-WRL/WRLA1 ranges objects from 0-cm to 1068-cm (35 feet) and provides range information from 20-cm to 1068-cm with a 1-cm resolution. This sensor is designed for applications where large object detection is needed to 10 meters.

## MB7066-MB7076

### XL-MaxSonar®-WRL/WRLA1 Beam Pattern

Sample results for measured beam pattern are shown on a 30-cm grid. The detection pattern is shown for dowels of varying diameters that are placed in front of the sensor

**A** 6.1-mm (0.25-inch) diameter dowel

**B** 2.54-cm (1-inch) diameter dowel

**C** 8.89-cm (3.5-inch) diameter dowel

**D** 11-inch wide board moved left to right with the board parallel to the front sensor face.

This shows the sensor's range capability.

**Note:** For people detection the pattern typically falls between charts A and B.

■ ■ Partial Detection

— 5.0 V

● 3.3 V

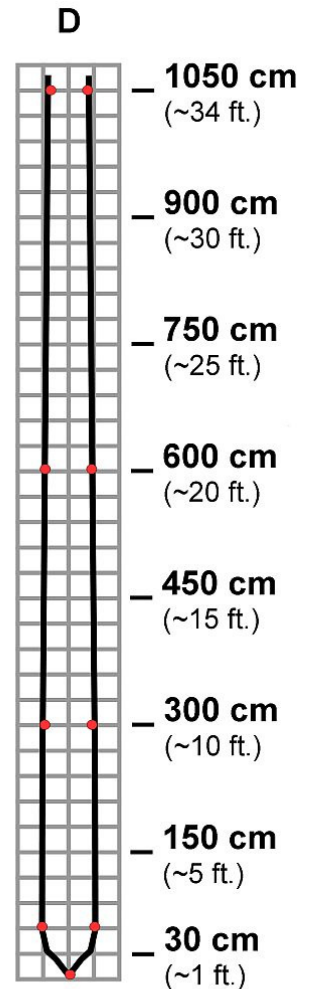
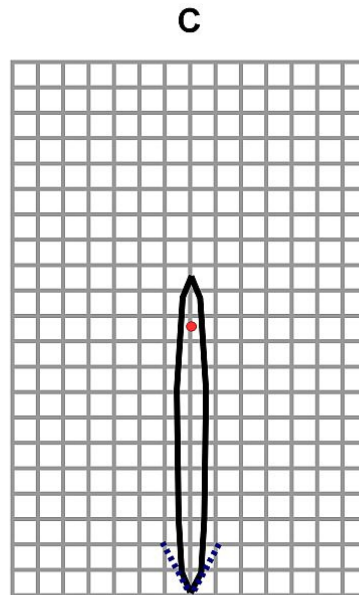
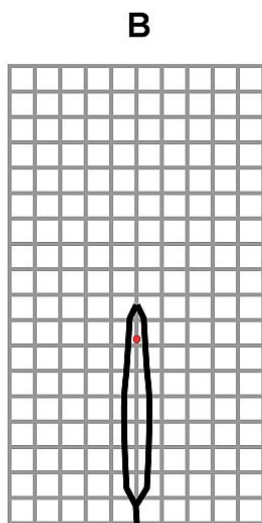
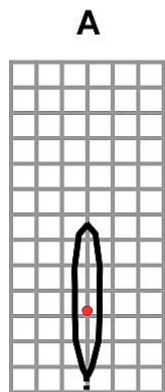

**Beam Characteristics are Approximate**

Beam Pattern drawn to a 1:95 scale for easy comparison to our other products.

### MB7066-MB7076

#### Features and Benefits

- Extended 10 meter range detection and outputs
- High acoustic power output
- Readings can occur up to every 100ms, 10-Hz rate
- Triggered operation provides the range reading as desired
- Fast measurement cycle
- Quality narrow beam characteristics
- Low cost, long range IP67 sensor

### MB7066-MB7076

#### Applications and Uses

- Robot ranging sensor
- Autonomous navigation
- Distance measuring
- Long range object detection
- Industrial sensor

# MB7067-MB7077 XL-MaxSonar®-WRC/WRCA1™ Beam Pattern and Uses

The XL-MaxSonar-WRC/WRCA1 is the compact version of the MB7060 and MB7070. The MB7067 and MB7077 sensors are ideal for applications where weight and size are restricted.

## MB7067-MB7077

### XL-MaxSonar®-WRC/WRCA1 Beam Pattern

Sample results for measured beam pattern are shown on a 30-cm grid. The detection pattern is shown for dowels of varying diameters that are placed in front of the sensor

**A** 6.1-mm (0.25-inch) diameter dowel

**B** 2.54-cm (1-inch) diameter dowel

**C** 8.89-cm (3.5-inch) diameter dowel

**D** 11-inch wide board moved left to right with the board parallel to the front sensor face.

This shows the sensor's range capability.

**Note:** For people detection the pattern typically falls between charts A and B.

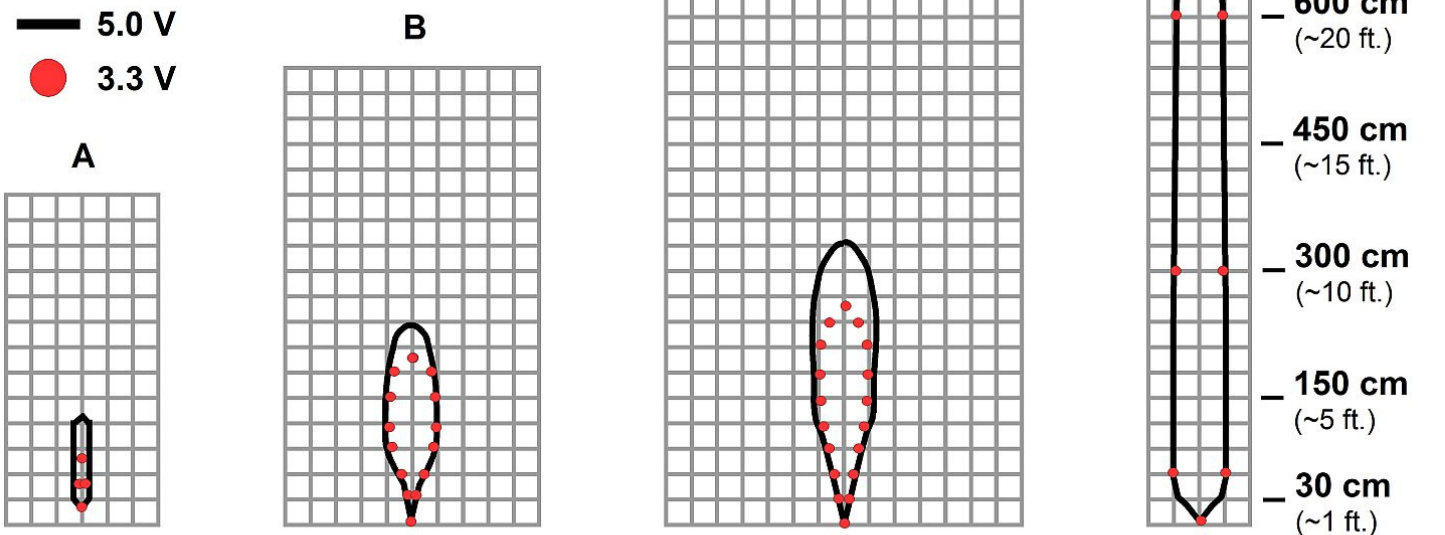

**Beam Characteristics are Approximate**

Beam Pattern drawn to a 1:95 scale for easy comparison to our other products.

### MB7067-MB7077

#### Features and Benefits

- Extra compact housing
- Designed for outdoor or indoor environments
- Lightweight, compact, weather resistant design
- Sensor dead zone is virtually gone
- Low cost IP67 sensor

### MB7067-MB7077

#### Applications and Uses

- UAV blimps
- Bin level measurement
- Proximity zone detection
- Robot ranging sensor

# MB7068-MB7078 XL-MaxSonar®-WRC/WRCA1™ Beam Pattern and Uses

The XL-MaxSonar-WRC/WRCA1 is the compact version of the MB7062 and MB7072. This sensor is well suited for applications where the MB7062 and 7072 are too heavy or too large.

## MB7068-MB7078 XL-MaxSonar®-WRC Beam Pattern

Sample results for measured beam pattern are shown on a 30-cm grid. The detection pattern is shown for dowels of varying diameters that are placed in front of the sensor

**A** 6.1-mm (0.25-inch) diameter dowel  
**B** 2.54-cm (1-inch) diameter dowel  
**C** 8.89-cm (3.5-inch) diameter dowel  
**D** 11-inch wide board moved left to right with the board parallel to the front sensor face. This shows the sensor's range capability.

**Note:** For people detection the pattern typically falls between charts A and B.

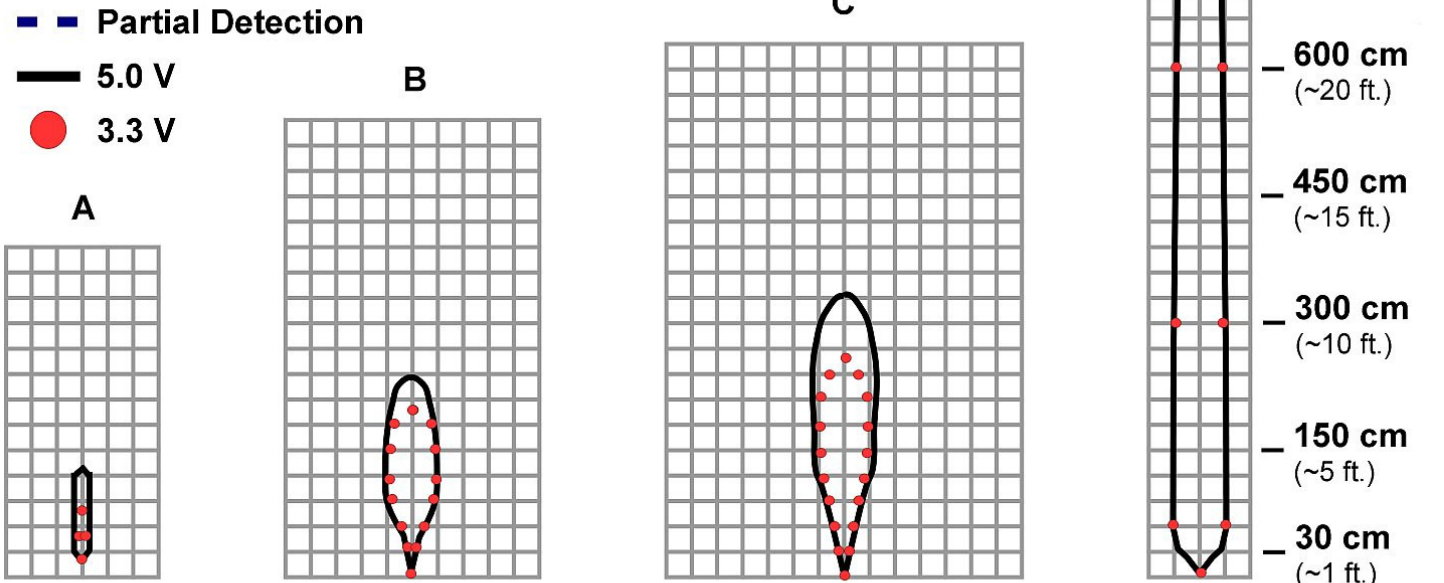

**Beam Characteristics are Approximate**

Beam Pattern drawn to a 1:95 scale for easy comparison to our other products.

### MB7068-MB7078

#### Features and Benefits

- 1 hour fail-safe built into sensor
- Extra compact housing
- Excellent for applications that require consistently accurate outputs
- Impressive acoustic and electrical noise resistance
- Lightweight, compact, weather resistant design

### MB7068-MB7078

#### Applications and Uses

- Environments with acoustic and electrical noise
- Bin Level Measurement
- Tank Level Measurement



Have the right MaxSonar for your application?

Check out our MaxSonar Product Lines

**Indoor Use**

(or protected environments)

**1 mm Resolution**  
HRLV-MaxSonar-EZ

**1 in Resolution**  
LV-MaxSonar-EZ  
LV-ProxSonar-EZ

**1 cm Resolution**  
XL-MaxSonar-EZ  
XL-MaxSonar-AE  
XL-MaxSonar-EZL  
XL-MaxSonar-AEL  
I2CXL-MaxSonar-EZ

**1 mm Resolution**  
HRUSB-MaxSonar-EZ

**1in Resolution**  
USB-ProxSonar-EZ

**Outdoor Use**

(or rugged environments) IP67

**1 mm Resolution**  
HRXL-MaxSonar-WR  
HRXL-MaxSonar-WRS  
HRXL-MaxSonar-WRT  
HRXL-MaxSonar-WRM  
HRXL-MaxSonar-WRMT  
HRXL-MaxSonar-WRL  
HRXL-MaxSonar-WRLT  
HRXL-MaxSonar-WRLS  
HRXL-MaxSonar-WRLST

**1 cm Resolution**  
XL-MaxSonar-WR  
XL-MaxSonar-WRL  
XL-MaxSonar-WRA  
XL-MaxSonar-WRLA  
I2CXL-MaxSonar-WR

**1 mm Resolution**  
HRXL-MaxSonar-WRC  
HRXL-MaxSonar-WRCT

**1 cm Resolution**  
XL-MaxSonar-WRC  
XL-MaxSonar-WRCA  
I2CXL-MaxSonar-WRC

**1 cm Resolution**  
UCXL-MaxSonar-WR  
UCXL-MaxSonar-WRC

**F-Option** Available for all WR models. For additional protection when necessary in hazardous

**Accessories-More information available online**

**MB7954 - Shielded Cable**

The MaxSonar Connection Wire is used to reduce interference caused by electrical noise on the lines. This cable is a great solution to use when running the sensors at a long distance or in an area with a lot of EMI and electrical noise.



**MB7950 - XL-MaxSonar-WR Mounting Hardware**

The MB7950 Mounting Hardware is selected for use with our outdoor ultrasonic sensors. The mounting hardware includes a steel lock nut and two O-ring (Buna-N and Neoprene) each optimal for different applications.



**MB7955 / MB7956 / MB7957 / MB7958 / MB7972 - HR-MaxTemp**

The HR-MaxTemp is an optional accessory for the HR-MaxSonar. The HR-MaxTemp connects to the HR-MaxSonar for automatic temperature compensation without self heating.



**MB7961 - Power Supply Filter**

The power supply filter is recommended for applications with unclean power or electrical noise.



**MB7962 / MB7963 / MB7964 / MB7965 - Micro-B USB Connection Cable**

The MB7962, MB7963, MB7964, and MB7965 Micro-B USB cables are USB2.0 compliant and backwards compatible with USB 1.0 standards. Varying lengths.



**MB7973 CE Compliance Widget**

The MB7973 adds protection for the CE requirement for Lightning/Surge IEC61000-4-5

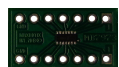

Product / specifications subject to change without notice. The names MaxBotix®, MaxSonar®, EZ, E20, E21, E22, E23, E24, HR, AE0, AE1, AE2, AE3, AE4, WR1, and WRC1 are trademarks of MaxBotix Inc.

## X-ON Electronics

Largest Supplier of Electrical and Electronic Components

*Click to view similar products for [Proximity Sensors](#) category:*

*Click to view products by [Maxbotix](#) manufacturer:*

Other Similar products are found below :

[01.001.5653.1](#) [70.340.1028.0](#) [70.360.2428.0](#) [70.364.4828.0](#) [70.810.1053.0](#) [72.360.1628.0](#) [73.363.6428.0](#) [9221350022](#) [980659-1](#) [QT-12](#)  
[E2EX10D1NN](#) [E2E-X14MD1-G](#) [E2E-X2D1-G](#) [E2EX2ME2N](#) [E2E-X3D1-N](#) [10M](#) [E2E-X4MD1-G](#) [E2FMX1R5D12M](#) [E2K-F10MC1](#) [5M](#)  
[EI1204TBOSL-6](#) [EI5515NPAP](#) [BSA-08-25-08](#) [IC08ANC15PO-K](#) [IMM2582C](#) [25.161.3253.0](#) [25.332.0653.1](#) [25.352.0653.0](#) [25.352.0753.0](#)  
[25.523.3253.0](#) [9151710023](#) [922FS1.5C-A4P-Z774](#) [SC606ABV0S30](#) [SM952A126100LE](#) [SM956A132600](#) [A1220EUA-T](#) [F3S-A162-U](#) [CL18](#)  
[QT-08L](#) [34.110.0010.0](#) [TL-C2MF1-M3-E4](#) [IA08BLF15NOM5](#) [IA08BSF15NOM5](#) [IA12ASF04DOM1](#) [IMM32188C](#) [IS2](#) [IS31SE5000-](#)  
[UTLS2-TR](#) [34.110.0021.0](#) [34.110.0022.0](#) [CA150-120VACDC](#) [VM18VA3000Q](#) [XS508BSCBL2](#)