

## Base strip - MC 1,5/19-GF-3,5 - 1843965

Please be informed that the data shown in this PDF Document is generated from our Online Catalog. Please find the complete data in the user's documentation. Our General Terms of Use for Downloads are valid (<http://phoenixcontact.com/download>)

Header, Nominal current: 8 A, Rated voltage (III/2): 160 V, Number of positions: 19, Pitch: 3.5 mm, Color: green, Contact surface: Tin, Mounting: Soldering



The figure shows a 10-position version of the product



### Key Commercial Data

Packing unit	1
GTIN	 4 017918 113070
Custom tariff number	85366990

### Technical data

#### Dimensions

Length	9.2 mm
Pitch	3.50 mm
Dimension a	63 mm
Constructional height	8 mm
Length of the solder pin	3.4 mm
Pin dimensions	0,8 x 0,8 mm
Hole diameter	1.2 mm

#### General

Range of articles	MC 1,5/...-GF
Insulating material group	IIIa
Rated surge voltage (III/3)	2.5 kV
Rated surge voltage (III/2)	2.5 kV
Rated surge voltage (II/2)	2.5 kV

## Base strip - MC 1,5/19-GF-3,5 - 1843965

### Technical data

#### General

Rated voltage (III/3)	160 V
Rated voltage (III/2)	160 V
Rated voltage (II/2)	250 V
Connection in acc. with standard	EN-VDE
Nominal current I <sub>N</sub>	8 A
Maximum load current	8 A
Insulating material	PBT
Flammability rating according to UL 94	V0
Color	green
Number of positions	19

#### Standards and Regulations

Connection in acc. with standard	EN-VDE
	CSA
Flammability rating according to UL 94	V0

### Classifications

#### eCl@ss

eCl@ss 4.0	272607xx
eCl@ss 4.1	27260701
eCl@ss 5.0	27260701
eCl@ss 5.1	27260701
eCl@ss 6.0	27260704
eCl@ss 7.0	27440402
eCl@ss 8.0	27440402

#### ETIM

ETIM 3.0	EC001121
ETIM 4.0	EC002637
ETIM 5.0	EC002637

#### UNSPSC

UNSPSC 6.01	30211810
UNSPSC 7.0901	39121409
UNSPSC 11	39121409
UNSPSC 12.01	39121409
UNSPSC 13.2	39121409

# Base strip - MC 1,5/19-GF-3,5 - 1843965

## Approvals

### Approvals

---

#### Approvals

CSA / VDE Gutachten mit Fertigungsüberwachung / IECEx CB Scheme / CCA / EAC / cULus Recognized

---

#### Ex Approvals

---

#### Approvals submitted

---

### Approval details

CSA 		
	B	D
Nominal current IN	8 A	8 A
Nominal voltage UN	300 V	300 V

VDE Gutachten mit Fertigungsüberwachung 	
Nominal current IN	8 A
Nominal voltage UN	160 V

IECEE CB Scheme 	
Nominal current IN	8 A
Nominal voltage UN	160 V

CCA	
Nominal current IN	8 A
Nominal voltage UN	160 V

# Base strip - MC 1,5/19-GF-3,5 - 1843965

## Approvals

EAC
-----

cULus Recognized		
	B	D
Nominal current I <sub>N</sub>	8 A	8 A
Nominal voltage U <sub>N</sub>	300 V	300 V

## Drawings

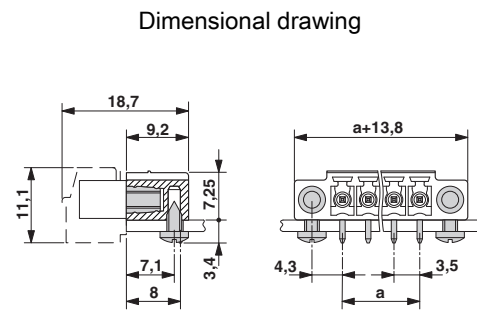
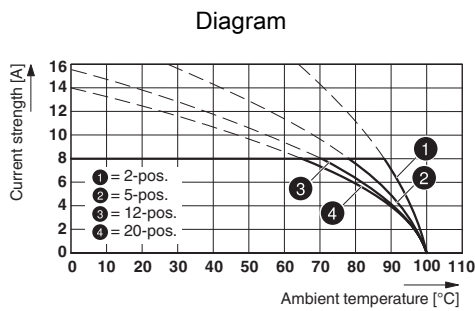

Type: FK-MCP 1,5/...-STF-3,5 with MC 1,5/...-GF-3,5

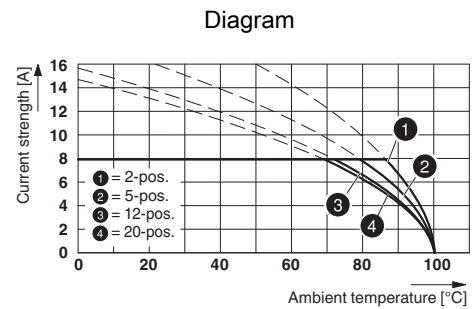
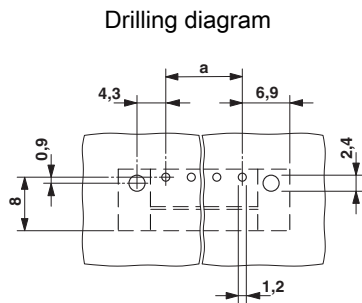

Type: MC 1,5/...-STF-3,5 with MC 1,5/...-GF-3,5

## X-ON Electronics

Largest Supplier of Electrical and Electronic Components

*Click to view similar products for [Headers & Wire Housings](#) category:*

*Click to view products by [Phoenix Contact](#) manufacturer:*

Other Similar products are found below :

[95000-104TRLF](#) [10135584-644402LF](#) [DF62W-EP2022PCA](#) [95000-106TRLF](#) [DF62W-2022SCA](#) [DF62W-EP2022PC](#) [2203348](#) [DF62W-2022SC](#) [1084018](#) [1029039](#) [1084017](#) [802-10-012-10-002000](#) [1112640](#) [1112639](#) [891-007-9SS-BST1T](#) [000-34000](#) [0008550134](#) [0009482033](#) [0009507031](#) [57102-F02-18ULF](#) [57102-S06-03LF](#) [57202-S52-04LF](#) [PCN6-15S-2.5E](#) [0039019024](#) [58102-G61-06LF](#) [582553-1](#) [0009485154](#) [0009508121](#) [0022285053](#) [0050291907](#) [018731A](#) [LY20-4P-DT1-P1E-BR](#) [02.125.8002.8](#) [60101931](#) [60598-1 \(Cut Strip\)](#) [M1625-3R/100](#) [61062-3](#) [61082-181009](#) [CSU011177004](#) [636-1427](#) [638009-1](#) [641938-9](#) [641991-4](#) [644168-1](#) [644827-2](#) [647662-1](#) [65039-019ELF](#) [65692-001LF](#) [65781-018](#) [65781-047](#)