

IEC Appliance Inlet C14 or C18 with Fuseholder 1- or 2-pole



Snap-in version



Approvals and Compliances

Description

- Panel Mount :
 Snap-in version , from front side Appliance Inlet , Protection class I , Fuseholder for fuse-links 5 x 20 mm
- Meets the requirements of IEC 60335-1 for appliances in unattended use. This includes the enhanced requirements of glow wire tests acc. to IEC 60695-2-12 and -13.
- Solder terminals or quick connect terminals

Characteristics

- The fuse drawer "Fingerrip" can be removed by hand

Weblinks

[pdf datasheet](#), [html-datasheet](#), [General Product Information](#), [Distributor-Stock-Check](#), [Accessories](#), [Detailed request for product](#)

Technical Data

Ratings IEC	10A / 250VAC; 50Hz
Ratings UL/CSA	10A / 250VAC; 60Hz
Dielectric Strength	> 3kVAC between L-N > 1.5kVAC between L/N-PE (1 min/50Hz)
Allowable Operation Temperature	-25°C to 70°C
IP-Protection	from front side IP 20 acc. to IEC 60529
Insulation cover	Suitable for appliances with protection class I or II acc. to IEC 61140
Terminal	Solder terminals or quick connect terminals
Panel Thickness S	Snap-in 1.0 - 2.5 mm
Material: Housing	PA6, black / grey / white, UL 94V-0

appliance inlet/-outlet	C14 / C18 acc. to IEC 60320-1 UL 498, CSA C22.2 no. 42 (for cold conditions) pin-temperature 70 °C, 10A, Protection Class I or II
Fuseholder	1 or 2 pole, acc. to IEC 60127-6, for fuse-links 5 x 20mm
Power Acceptance @ Ta > 23°C	Admissible power acceptance at higher ambient temperature see derating curves

Approvals and Compliances

Detailed information on product approvals, code requirements, usage instructions and detailed test conditions can be looked up in [Details about Approvals](#)

Approvals





The approval mark is used by the testing authorities to certify compliance with the safety requirements placed on electronic products.

Approval Reference Type: 1064

Approval Logo	Certificates	Certification Body	Description
	SEMKO Approvals	SEMKO	Certificate Number: SE/09137-1A
	UL Approvals	UL	UL File Number: E93617
	CSA Approvals	CSA	CSA Certification Record: 27324
	CSA Approvals	CSA	CCC File Number: 27324



Product standards

Product standards that are referenced

Organization	Design	Standard	Description
	Designed according to	IEC 60320-1	Appliance couplers for household and similar general purposes
	Designed according to	IEC 60127-6	Miniature fuses. Part 6. Fuse-holders for miniature fuse-links
	Designed according to	IEC 61058-1	Switches for appliances. Part 1. General requirements
	Designed according to	UL 498	Standard for Attachment Plugs and Receptacles
	Designed according to	CSA C22.2 no. 42	General Use Receptacles, Attachment Plugs, and Similar Wiring Devices





Application standards

Application standards where the product can be used

Organization	Design	Standard	Description
	Designed for applications acc.	IEC/UL 60950	IEC 60950-1 includes the basic requirements for the safety of information technology equipment.
	Designed for applications acc.	IEC 60335-1	Safety of electrical appliances for household and similar purposes. Meets the requirements for appliances in unattended use. This includes the enhanced requirements of glow wire tests acc. to IEC 60695-2-12 and -13.

Compliances

The product complies with following Guide Lines

Identification	Details	Initiator	Description
	CE declaration of conformity	SCHURTER AG	The CE marking declares that the product complies with the applicable requirements laid down in the harmonisation of Community legislation on its affixing in accordance with EU Regulation 765/2008.
	RoHS	SCHURTER AG	EU Directive RoHS 2011/65/EU
	China RoHS	SCHURTER AG	The law SJ / T 11363-2006 (China RoHS) has been in force since 1 March 2007. It is similar to the EU directive RoHS.
	REACH	SCHURTER AG	On 1 June 2007, Regulation (EC) No 1907/2006 on the Registration, Evaluation, Authorization and Restriction of Chemicals 1 (abbreviated as "REACH") entered into force.

Dimensions [mm]

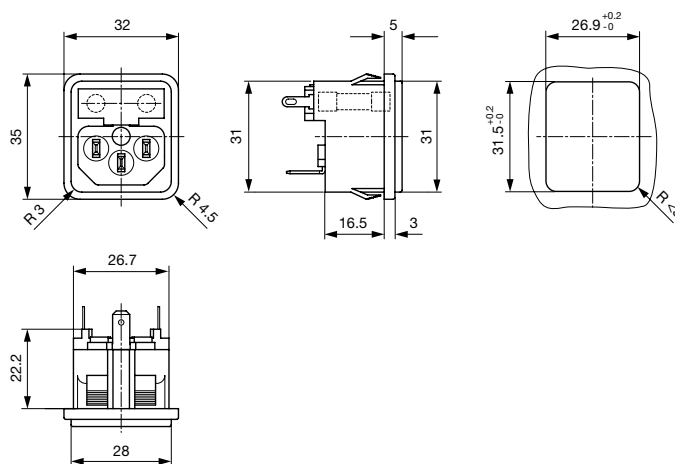

Length of the terminal please find at the order code configuration table

Derating Curves

Fuses
 5 x 20 mm (1-pole)

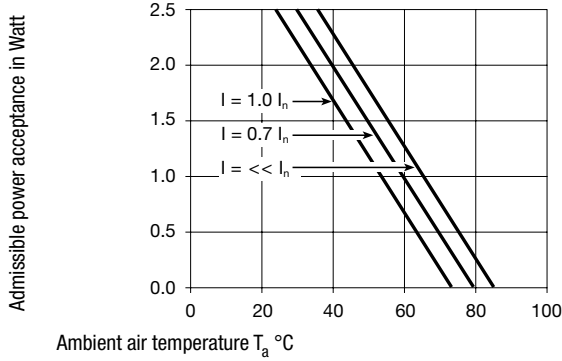

2-pole

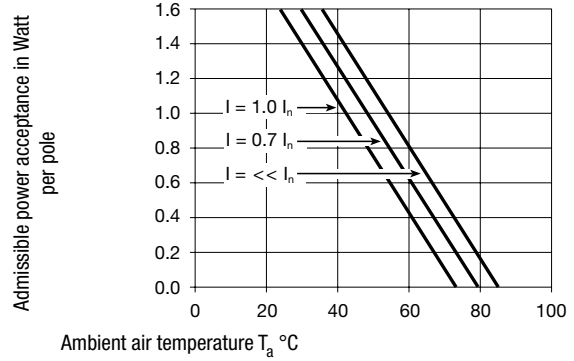

Config. Code

1064 - H - A B C N - D - E G O

The characters are placeholders for the correspondingly keys of selections from the key tables.





1064 - **H** - A B C N - D - E G O = Type

Type	Configuration key
protection class II	B
protection class I	X

Terminal Ground	Configuration key
without terminal	0
short solder terminal (L = 4.8 mm)	2
long solder terminal (L = 8.5 mm)	3
Blade terminal (4.8 x 0.8 mm)	8
Blade terminal (6.3 x 0.8 mm)	9

Symbols similar as in table A

1064 - H - **A** B C N - D - E G O = Terminals

Terminal L	Configuration key
short solder terminal (L = 4.8 mm) 	2
long solder terminal (L = 8.5 mm) 	3
Blade terminal (4.8 x 0.8 mm) 	8
Blade terminal (6.3 x 0.8 mm) 	9
connection to fuse holder	B

1064 - H - A B C **N** - D - E G O = Terminal Fuseholder

Terminal Fuseholder	Configuration key
solder terminal	1

1064 - H - A B C N - **D** - E G O = Color

Color	Configuration key
Black	A
Grey	B
White	D

1064 - H - A **B** C N - D - E G O = Terminals

Terminal N	Configuration key
short solder terminal (L = 4.8 mm)	2
long solder terminal (L = 8.5 mm)	3
Blade terminal (4.8 x 0.8 mm)	8
Blade terminal (6.3 x 0.8 mm)	9
connection to fuse holder	B

Symbols similar as in table A

1064 - H - A B C N - D - **E** G O = Style

Style	Configuration key
snap-in standard type	3

1064 - H - A B C N - D - E **G** O = Dimension S

Dimension "S"	Configuration key
00	

The dimension "S" is displayed in (1/10 mm). This information is also valid for the order code

1064 - H - A B **C** N - D - E G O = Terminals

1064 - H - A B C N - D - E G O = Features

Features	Configuration key
dead cover	1

Features	Configuration key
holder for 1 or 2 fuses (text legible, when inlet on top)	4
holder for 1 or 2 fuses (text legible, when inlet on bottom)	5

All Variants

Type	Terminal L	Terminal N	Terminal Ground	Color	Style	Features	Config. Code	Order Number
protection class I	connection to fuse holder	short solder terminal (L = 4.8 mm)	short solder terminal (L = 4.8 mm)	Black	snap-in standard type	holder for 1 or 2 fuses (text legible, when inlet on top)	1064-X-B221-A-3004	4304.6025
protection class I	connection to fuse holder	Blade terminal (4.8 x 0.8 mm)	Blade terminal (4.8 x 0.8 mm)	Black	snap-in standard type	holder for 1 or 2 fuses (text legible, when inlet on top)	1064-X-B881-A-3004	4304.6026
protection class I	connection to fuse holder	Blade terminal (6.3 x 0.8 mm)	Blade terminal (6.3 x 0.8 mm)	Black	snap-in standard type	holder for 1 or 2 fuses (text legible, when inlet on top)	1064-X-B991-A-3004	4304.6027
protection class I	connection to fuse holder	connection to fuse holder	short solder terminal (L = 4.8 mm)	Black	snap-in standard type	holder for 1 or 2 fuses (text legible, when inlet on top)	1064-X-BB21-A-3004	4304.6028
protection class I	connection to fuse holder	connection to fuse holder	short solder terminal (L = 4.8 mm)	Black	snap-in standard type	holder for 1 or 2 fuses (text legible, when inlet on bottom)	1064-X-BB21-A-3005	4304.6029
protection class I	connection to fuse holder	connection to fuse holder	Blade terminal (4.8 x 0.8 mm)	Black	snap-in standard type	holder for 1 or 2 fuses (text legible, when inlet on top)	1064-X-BB81-A-3004	4304.6030
protection class I	connection to fuse holder	connection to fuse holder	Blade terminal (6.3 x 0.8 mm)	Black	snap-in standard type	holder for 1 or 2 fuses (text legible, when inlet on top)	1064-X-BB91-A-3004	4304.6031
protection class I	connection to fuse holder	connection to fuse holder	short solder terminal (L = 4.8 mm)	White	snap-in standard type	holder for 1 or 2 fuses (text legible, when inlet on top)	1064-X-BB21-D-3004	4304.6129

The listed variants should be available from stock. Other versions on request www.schurter.com/contact

Most Popular.

Availability for all products can be searched real-time: <https://www.schurter.com/en/Stock-Check/Stock-Check-SCHURTER>

Packaging unit 50 Pcs

Accessories

Description

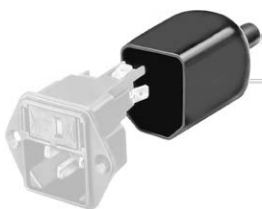

Assorted Covers
Rear Cover

Mating Outlets/Connectors

Category / Description



[Appliance Outlet Overview complete](#)

IEC Appliance Outlet F, Screw-on Mounting, Front Side, Solder Terminal	4787
IEC Appliance Outlet F, Snap-in Mounting, Front Side, Solder or Quick-connect Terminal	4788
IEC Appliance Outlet F or H, Screw-on Mounting, Front Side, Solder, PCB or Quick-connect Terminal	5091

[Appliance Outlet further types to 1064](#)

[Connector Overview complete](#)



4782 Mounting: Power Cord, 3 x 1 mm ² / 3 x 18 AWG, Cable, Connector: IEC C13	4782
4022 Mounting: Power Supply Cord, 3 x 1.5 mm ² , Screw clamps, Connector: IEC C13	4022
4785 Mounting: Power Cord, 3 x 1 mm ² / 3 x 18 AWG, Cable, Connector: IEC C13	4785
4300-06 Mounting: Power Cord, 3 x 1 mm ² / 3 x 18 AWG, Cable, Connector: IEC C13	4300-06
4012 Mounting: Power Supply Cord, 3 x 1.5 mm ² , Screw clamps, Connector: IEC C13	4012

[Connector further types to 1064](#)

...

Mating Outlets/Connectors shuttered



[Power Cord Overview complete](#)

Power cord with IEC connector C17, V-Lock, straight	VAC17KS
---	---------

[Power Cord further types to 1064](#)

X-ON Electronics

Largest Supplier of Electrical and Electronic Components

Click to view similar products for [AC Power Entry Modules](#) category:

Click to view products by [Schurter](#) manufacturer:

Other Similar products are found below :

[0098.0050](#) [6-1609987-9](#) [6167.0002](#) [7-6609955-2](#) [FN389-4-22](#) [FN9233ER-12-06](#) [FN9233S1-10-06](#) [FN9233S1-8-06](#) [FN9233S1B-8-06](#)
[FN9233S1R-1-06](#) [FN9233S1R-12-06](#) [FN9233SB-1-06](#) [FN9233SB-12-06](#) [FN9233SB-8-06](#) [FN9233SR-10-06](#) [FN9233SR-3-06](#) [FN9244B-15-06HI](#) [FN9244EB-3-06](#) [FN9244EB-8-06](#) [FN9244ER-15-06](#) [FN9244ER-8-06](#) [FN9244ES1-8-06](#) [FN9244ESB-8-06](#) [FN9244EU-6-06](#)
[FN9244R-12-06](#) [FN9244R-3-07](#) [FN9244R-8-06](#) [FN9244S1-10-06](#) [FN9244S1-12-06](#) [FN9244S1-3-06](#) [FN9244S1B-6-06](#) [FN9244S1R-3-06](#)
[FN9244S-6-06](#) [FN9244SB-10-06](#) [FN9244SB-6-06](#) [FN9244SB-8-06](#) [FN9244SR-10-06](#) [FN9244SR-6-06](#) [FN9244U-3-06](#) [FN9244U-8-06](#)
[FN9260A-6-06](#) [PE00SSSXB](#) [Fuse-H-EUR-1](#) [Fuse-H-USA-1](#) [PM00XD000](#) [PS0SSDBX0](#) [PS0SXSH3B](#) [A-0701-HT-H](#) [RAPC3FG](#) [15EJMS8](#)