

PLASTIC PACKAGE INDUSTRIAL GRADE ULTRA MINIATURE PURE SILICON™ CLOCK OSCILLATOR

ASVMB



7.0 x 5.0 x 0.85 mm

ASVMB

RoHS/RoHS II Compliant

Moisture Sensitivity Level – MSL 1

FEATURES:

- Pure Silicon™ Clock Oscillator
- 2nd Generation MEMS Technology with reduced jitter by Discera
- Low Power Consumption <10mA
- Exceptional Stability +/- 10ppm Over Temp. at -40 to +105°C
- Compact QFN Plastic Packaging

APPLICATIONS:

- CCD Clock for VTR Camera
- Equipment Connected to PCs
- Low Profile Equipment
- Computers and Peripherals
- Lower Cost Crystal Oscillator Replacement
- Portable Electronics (MP3 Players, Games)
- Consumer Electronics such as TV's, DVR's, etc.
- Vibrant, Shock-Prone & Humid Environments for Industrial Equipment
- Demanding Military & Automotive Electronics

**MEMS
TECHNOLOGY**

STANDARD SPECIFICATIONS:

Common Key Electrical Specifications

Parameters	Minimum	Typical	Maximum	Units	Notes
Frequency Range:	1.0		150	MHz	
Operating Temperature:	0		+70	°C	See options
Storage Temperature:	-55		+150	°C	
Overall Frequency Stability*:	-50		+50	ppm	See options
Supply Voltage (Vdd):	+1.8 ~ +3.3			V	
Output Load:	10		15, 25, or 40	pF kΩ	See options
Symmetry:	45		55	%	@1/2Vdd
Startup Time:		1.5	3.0	ms	
Disable Time:		20	100	ns	
Disable Stand-by Current:			15	uA	
Tri-state Function (Stand-by) :	"1" (VIH≥0.75*Vdd) or Open: Oscillation "0" (VIL<0.25*Vdd) : Hi Z			V	
Aging:	-5.0		+5.0	ppm	First year

Key Electrical Specifications – V_{dd} = 1.8V

Parameters	Minimum	Typical	Maximum	Units	Notes
Supply Current (no load):	1.0 to 39.9999MHz	5	15	mA	CL=0p
	40.0 to 79.9999MHz	6	15	mA	RL=∞
	80.0 to 124.9999MHz	7	15	mA	T=25°C
	125.0 to 150MHz	8	15	mA	(Standard CL: 15pF)
	1.0 to 39.9999MHz	6	15	mA	CL=0p
	40.0 to 79.9999MHz	7	15	mA	RL=∞
	80.0 to 124.9999MHz	8	15	mA	T=25°C
	125.0 to 150MHz	9	15	mA	(CL option: 25pF)
	1.0 to 39.9999MHz	7	15	mA	CL=0p
	40.0 to 79.9999MHz	8	15	mA	RL=∞
	80.0 to 124.9999MHz	9	15	mA	T=25°C
	125.0 to 150MHz	10	15	mA	(CL option: 40pF)
Output Voltage:	V _{OH}	0.8*V _{dd}		V	
	V _{OL}		0.2*V _{dd}	V	CL=15, 25, 40pF
Rise Time: Fall Time:	Tr	1.8	3.0	ns	CL=15pF; T=25°C
	Tf	1.0	3.0	ns	20%/80%*VDD
	Tr	1.5	3.0	ns	CL=25pF; T=25°C
	Tf	1.2	3.0	ns	20%/80%*VDD
	Tr	1.4	3.0	ns	CL=40pF; T=25°C
	Tf	1.1	3.0	ns	20%/80%*VDD
Cycle to Cycle Jitter:		60		ps	F=100MHz
Period Jitter RMS:		10		ps	F=100MHz

ABRACON IS
ISO9001:2008
CERTIFIED

ABRACON LLC
The Power of Linking Together

2 Faraday, Suite# B | Irvine | CA 92618 Revised: 04.30.15
Ph. 949.546.8000 | Fax. 949.546.8001
Visit www.abracon.com for Terms and Conditions of Sale

PLASTIC PACKAGE INDUSTRIAL GRADE ULTRA MINIATURE PURE SILICON™ CLOCK OSCILLATOR



ASVMB

7.0 x 5.0 x 0.85 mm

ASVMB

RoHS/RoHS II Compliant

Key Electrical Specifications – $V_{dd} = 2.5V$

Parameters		Minimum	Typical	Maximum	Units	Notes
Supply Current (no load):	1.0 to 39.9999MHz		6	15	mA	CL=0p RL=∞ T=25°C (Standard CL: 15pF)
	40.0 to 79.9999MHz		7	15	mA	
	80.0 to 124.9999MHz		8	15	mA	
	125.0 to 150MHz		9	15	mA	
	1.0 to 39.9999MHz		7	15	mA	CL=0p RL=∞ T=25°C (CL option: 25pF)
	40.0 to 79.9999MHz		8	15	mA	
	80.0 to 124.9999MHz		9	15	mA	
	125.0 to 150MHz		10	15	mA	
	1.0 to 39.9999MHz		8	16	mA	CL=0p RL=∞ T=25°C (CL option: 40pF)
	40.0 to 79.9999MHz		9	16	mA	
	80.0 to 124.9999MHz		10	16	mA	
	125.0 to 150MHz		11	16	mA	
Output Voltage:	V_{OH}	$0.8 \cdot V_{dd}$			V	CL=15, 25pF
	V_{OL}			$0.2 \cdot V_{dd}$	V	
	V_{OH}	$0.9 \cdot V_{dd}$			V	
	V_{OL}			$0.1 \cdot V_{dd}$	V	
Rise Time: Fall Time:	T_r		1.0	2.0	ns	CL=15pF; T=25°C 20%/80%*VDD
	T_f		0.9	2.0	ns	
	T_r		1.1	2.0	ns	CL=25pF; T=25°C 20%/80%*VDD
	T_f		0.9	2.0	ns	
	T_r		1.0	2.0	ns	CL=40pF; T=25°C 20%/80%*VDD
	T_f		0.9	2.0	ns	
Cycle to Cycle Jitter:			50		ps	F=100MHz
Period Jitter RMS:			5		ps	F=100MHz

Key Electrical Specifications – $V_{dd} = 3.3V$

Parameters		Minimum	Typical	Maximum	Units	Notes
Supply Current (no load):	1.0 to 39.9999MHz		7	15	mA	CL=0p RL=∞ T=25°C (Standard CL: 15pF)
	40.0 to 79.9999MHz		8	15	mA	
	80.0 to 124.9999MHz		9	15	mA	
	125.0 to 150MHz		10	15	mA	
	1.0 to 39.9999MHz		8	16	mA	CL=0p RL=∞ T=25°C (CL option: 25pF)
	40.0 to 79.9999MHz		9	16	mA	
	80.0 to 124.9999MHz		10	16	mA	
	125.0 to 150MHz		11	16	mA	
	1.0 to 39.9999MHz		8	16	mA	CL=0p RL=∞ T=25°C (CL option: 40pF)
	40.0 to 79.9999MHz		9	16	mA	
	80.0 to 124.9999MHz		10	16	mA	
	125.0 to 150MHz		11	16	mA	
Output Voltage:	V_{OH}	$0.8 \cdot V_{dd}$			V	CL=15pF
	V_{OL}			$0.2 \cdot V_{dd}$	V	
	V_{OH}	$0.9 \cdot V_{dd}$			V	
	V_{OL}			$0.1 \cdot V_{dd}$	V	
Rise Time: Fall Time:	T_r		1.0	2.0	ns	CL=15pF; T=25°C 20%/80%*VDD
	T_f		0.9	2.0	ns	
	T_r		1.0	2.0	ns	CL=25pF; T=25°C 20%/80%*VDD
	T_f		0.9	2.0	ns	
	T_r		0.8	2.0	ns	CL=40pF; T=25°C 20%/80%*VDD
	T_f		0.8	2.0	ns	
Cycle to Cycle Jitter:			50		ps	F=100MHz
Period Jitter RMS:			5		ps	F=100MHz

ABRACON IS
ISO9001:2008
CERTIFIED



2 Faraday, Suite# B | Irvine | CA 92618 Revised: 04.30.15
Ph. 949.546.8000 | Fax. 949.546.8001
Visit www.abracon.com for Terms and Conditions of Sale

PLASTIC PACKAGE INDUSTRIAL GRADE ULTRA MINIATURE PURE SILICON™ CLOCK OSCILLATOR



7.0 x 5.0 x 0.85 mm

ASVMB

RoHS/RoHS II Compliant

Absolute Maximum Ratings

Item	Minimum	Maximum	Unit	Condition
Supply Voltage	-0.3	+4.0	V	
Input Voltage	-0.3	Vdd+0.3	V	
Junction Temp.		+150	°C	
Storage Temp.	-55	+150	°C	
Soldering Temp.		+260	°C	40sec max
ESD			V	
HBM		4,000		
MM		200		
CDM		1,500		

OPTIONS AND PART IDENTIFICATION: (Left Blank if Standard)

Programmed Orders (Quantity > 1,000pcs)

ASVMB - MHz - - -

Frequency in MHz	Operating Temp.	Overall Freq. Stability	Output Load	Packaging
e.g. 14.3181 MHz (Maximum 4 digits after decimal)	Blank: 0°C ~ +70°C E: -20°C ~ +70°C L: -40°C ~ +85°C X: -40°C ~ +105°C	C: ±50ppm (STD) Y: ±10ppm R: ±25 ppm	Blank: 15pF 25: 25pF 40: 40pF	Blank*: 50pcs / Tube T: 1,000pcs / reel T3: 3,000pcs / reel

* For Quick turn-around programmable orders < 1000pcs: Due to the immediate availability of stock and the qty of the order, the parts may be delivered as BULK: Cut Tape, Loose parts in Antistatic Bag or in Tube(s). The MOQ per the series will still apply for Tube packaging.

Un-Programmed Orders

Blank un-programmed oscillators and our low cost portable programmer are available for quick turn engineering requirements. Please call ABRACON or visit MEMSpeed Pro site <http://www.abracon.com/memspeedpro/memspeedpro.html> for more information.

ASVMB - BLANK - - - -

Operating Temp.	Overall Freq. Stability	Output Load	Packaging
Blank: 0°C ~ +70°C E: -20°C ~ +70°C L: -40°C ~ +85°C X: -40°C ~ +105°C	C: ±50ppm (STD) Y: ±10ppm R: ±25 ppm	Blank: 15pF 25: 25pF 40: 40pF	Blank: 50pcs / Tube T: 1,000pcs / reel T3: 3,000pcs / reel

ABRACON IS
ISO9001:2008
CERTIFIED



2 Faraday, Suite# B | Irvine | CA 92618 Revised: 04.30.15
Ph. 949.546.8000 | Fax. 949.546.8001
Visit www.abracon.com for Terms and Conditions of Sale

PLASTIC PACKAGE INDUSTRIAL GRADE ULTRA MINIATURE PURE SILICON™ CLOCK OSCILLATOR

ASVMB



7.0 x 5.0 x 0.85 mm

ASVMB

Pb RoHS/RoHS II Compliant

OUTLINE DIMENSIONS:

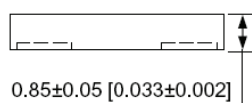
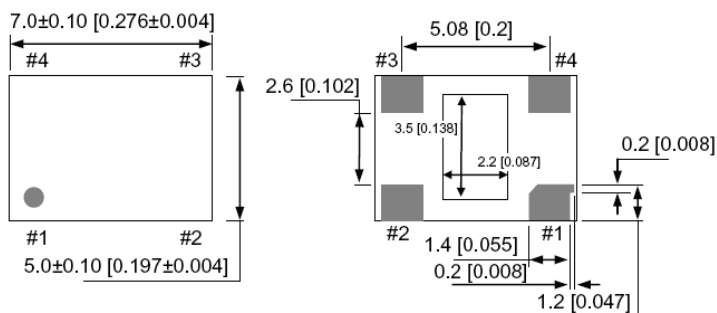

No.	Pin Terminal
1	Standby
2	GND
3	Output
4	VDD

Center Pad: NC/GND

Recommended Land Pattern

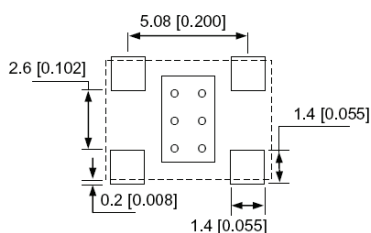

Note: Recommend using an approximately 0.01uF bypass capacitor between PIN 2 and 4.

Dimensions: mm (inches)

TAPE AND REEL:

T= 1,000pcs/reel (D=180mm)

T3= 3,000pcs/reel (D=330mm)

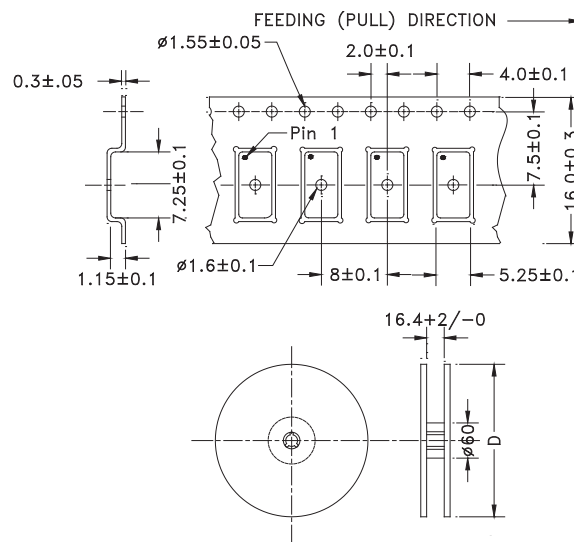

Tube: 50 pcs/tube

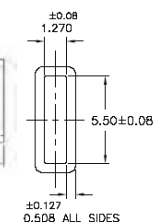
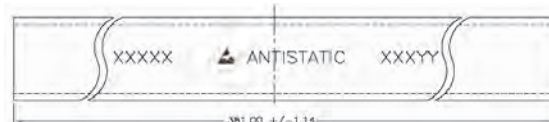

Unit orientation in tube:



Dimensions: mm

REFLOW PROFILE:

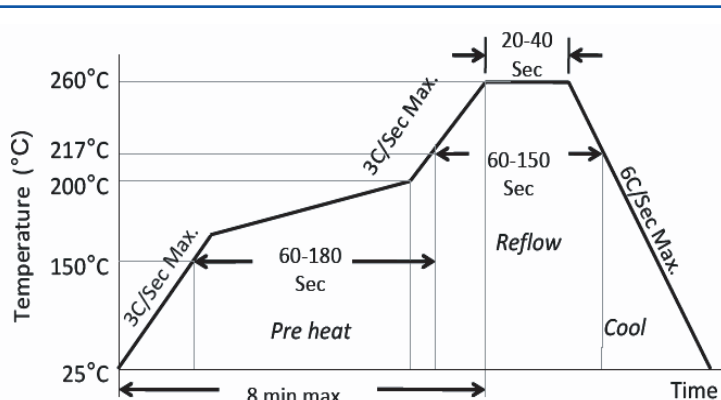

Ramp-Up Rate (200°C to Peak Temp)	3°C/Sec Max.
Preheat Time 150°C to 200°C	60-180 Sec
Time maintained above 217°C	60-150 Sec
Peak Temperature	255-260°C
Time within 5°C of actual Peak	20-40 Sec
Ramp-Down Rate	6°C/Sec Max.
Time 25°C to Peak Temperature	8 min Max.

ATTENTION: Abracon Corporation's products are COTS – Commercial-Off-The-Shelf products; suitable for Commercial, Industrial and, where designated, Automotive Applications. Abracon's products are not specifically designed for Military, Aviation, Aerospace, Life-dependant Medical applications or any application requiring high reliability where component failure could result in loss of life and/or property. For applications requiring high reliability and/or presenting an extreme operating environment, written consent and authorization from Abracon Corporation is required. Please contact Abracon Corporation for more information.

ABRACON IS
ISO9001:2008
CERTIFIED



ABRACON[®]
LLC

2 Faraday, Suite# B | Irvine | CA 92618 Revised: 04.30.15

Ph. 949.546.8000 | Fax. 949.546.8001

Visit www.abracon.com for Terms and Conditions of Sale

X-ON Electronics

Largest Supplier of Electrical and Electronic Components

Click to view similar products for [Standard Clock Oscillators](#) category:

Click to view products by [ABRACON](#) manufacturer:

Other Similar products are found below :

[EP1400SJTSC-125.000M](#) [601137](#) [601252](#) [CSX750FBC-24.000M-UT](#) [CSX750FBC-33.333M-UT](#) [CSX750FCC-3.6864M-UT](#) [F335-12](#) [F335-25](#) [F535L-50](#) [DSC506-03FM2](#) [ASA-20.000MHZ-L-T](#) [ASA-25.000MHZ-L-T](#) [ASA-27.000MHZ-L-T](#) [ASV-20.000MHZ-LR-T](#) [ECS-2018-160-BN-TR](#) [EL13C7-H2F-125.00M](#) [MXO45HS-2C-66.6666MHZ](#) [NBXDBB017LN1TAG](#) [NBXHBA019LN1TAG](#) [SiT1602BI-22-33E-50.000000E](#) [SIT8003AC-11-33S-2.04800X](#) [SiT8256AC-23-33E-156.250000X](#) [SIT8918AA-11-33S-50.000000G](#) [SM4420TEV-40.0M-T1K](#) [SMA4306-TL-H](#) [F335-24](#) [F335-40](#) [F335-50](#) [F535L-10](#) [F535L-12](#) [F535L-16](#) [F535L-24](#) [F535L-27](#) [F535L-48](#) [PE7744DW-100.0M](#) [CSX750FBC-20.000M-UT](#) [CSX-750FBC33333000T](#) [CSX750FBC-4.000M-UT](#) [CSX750FBC-7.3728M-UT](#) [CSX750FBC-8.000M-UT](#) [CSX-750FCC14745600T](#) [CSX750FCC-16.000M-UT](#) [CSX-750FCC40000000T](#) [CSX750FCC-4.000M-UT](#) [ASA-22.000MHZ-L-T](#) [ASA2-26.000MHZ-L-T](#) [ASA-40.000MHZ-L-T](#) [ASA-48.000MHZ-L-T](#) [ASA-60.000MHZ-L-T](#) [ASF1-3.686MHZ-N-K-S](#)