

---

## 18V Input, 3A Output, High Efficiency Synchronous Buck Regulator with Power Good Indication

---

### Features

- Up to 95% Typical Efficiency
- Input Voltage Range: 6.0V to 18V
- 3A Output Current
- Fixed Output Voltages: 0.9V, 1.5V, 1.8V, 2.5V, 3.3V, 5V with 2% Output Voltage Accuracy
- Adjustable Version Output Voltage Range: 0.9V to 5V with 1.5% Reference Voltage Accuracy
- Integrated N-Channel High-Side Switch: 180 m $\Omega$
- Integrated N-Channel Low-Side Switch: 120 m $\Omega$
- 1 MHz Fixed Frequency
- Low Device Shutdown Current
- Peak Current Mode Control
- Internal Compensation
- Stable with Ceramic Capacitors
- Internal Soft-Start
- Cycle-by-Cycle Peak Current Limit
- Under Voltage Lockout (UVLO): 5.75V
- Overtemperature Protection
- $V_{OUT}$  Overvoltage Protection
- $V_{OUT}$  Voltage Supervisor Reported at the PG Pin
- Available Package: QFN-16 (3x3 mm)

### Applications

- PIC<sup>®</sup>/dsPIC<sup>®</sup> Microcontroller Bias Supply
- 12V Industrial Input DC-DC Conversion
- Set-Top Boxes
- DSL Cable Modems
- Automotive
- Wall Cube Regulation
- SLA Battery Powered Devices
- AC-DC Digital Control Power Source
- Power Meters
- Consumer
- Medical and Health Care
- Distributed Power Supplies

### Description

The MCP16323 is a highly integrated, high-efficiency, fixed frequency, synchronous step-down DC-DC converter in a 16-pin QFN package that operates from input voltages up to 18V. Integrated features include a high-side and low-side N-Channel switch, fixed frequency Peak Current Mode Control, internal compensation, peak current limit,  $V_{OUT}$  overvoltage protection and overtemperature protection. Minimal external components are necessary to develop a complete synchronous step-down DC-DC converter power supply.

High converter efficiency is achieved by integrating a high-speed, current limited, low resistance, high-side N-Channel MOSFET, as well as a high-speed, low-resistance, low-side N-Channel MOSFET and associated drive circuitry. High switching frequency minimizes the size of the inductor and output capacitor, resulting in a small solution size.

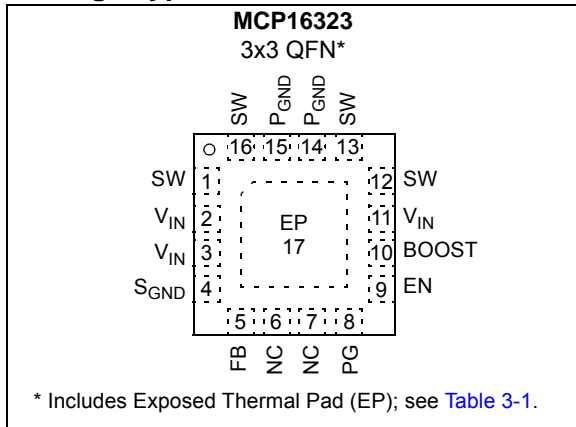
The MCP16323 device can supply 3A of continuous current while regulating the output voltage from 0.9V to 5V. A high-performance peak current mode architecture keeps the output voltage tightly regulated, even during input voltage steps and output current transient conditions that are common in power supplies.

The regulator can be turned on and off with a logic level signal applied to the EN input. The EN pin is internally pulled up to a 4.2V reference and is rated for a maximum of 6V. With EN low, typically 5  $\mu$ A of current is consumed from the input, making the part ideal for power shedding and load distribution applications. The PG output is an open drain output pin used to interface with other components of the system, and can be pulled up to a maximum of 6V.

The output voltage can either be fixed at output voltages of 0.9V, 1.5V, 1.8V, 2.5V, 3.3V, 5V or adjustable using an external resistor divider. The MCP16323 is offered in a 3x3 QFN-16 surface mount package.

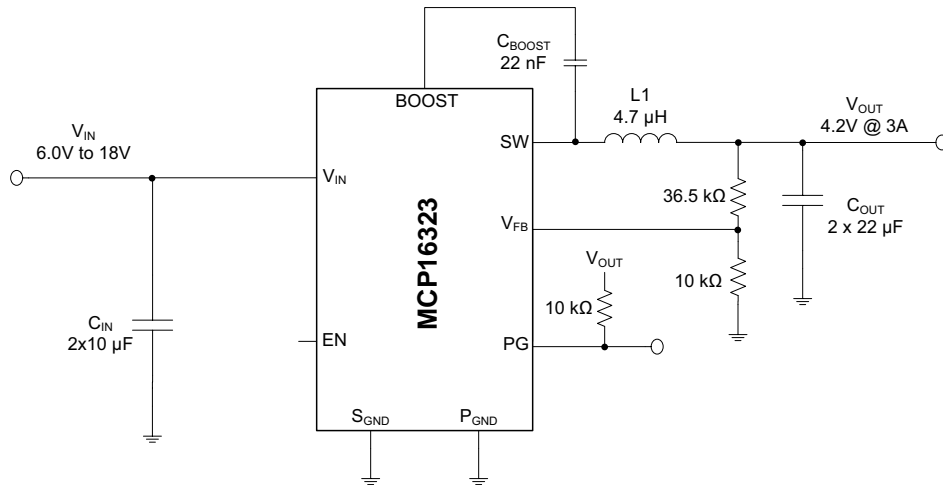
# MCP16323

## Package Type

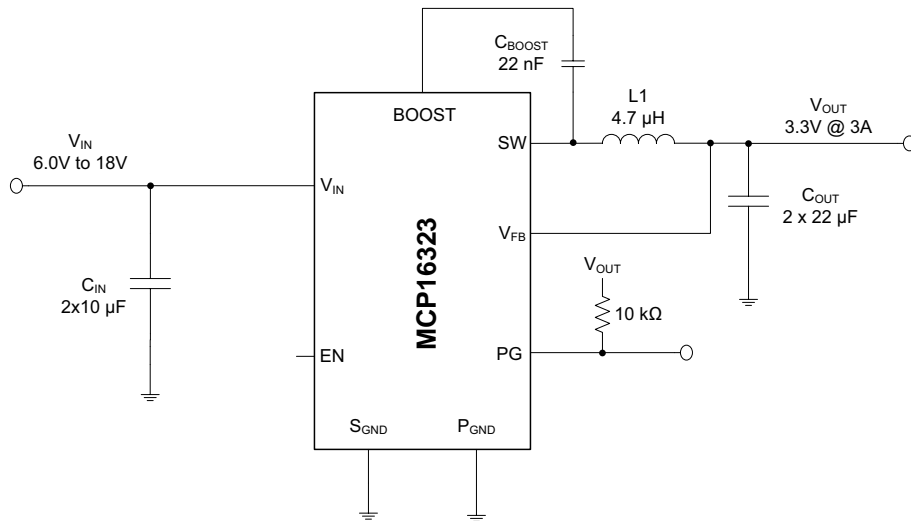


## Typical Applications

### Typical Application with Adjustable Output Voltage



### Typical Application with Fixed Output Voltage



## 1.0 ELECTRICAL CHARACTERISTICS

### Absolute Maximum Ratings†

$V_{IN}$ .....	-0.3V to 20V
SW .....	-1V to 20V
BOOST – GND .....	-0.3V to ( $V_{IN}+6V$ )
EN, $V_{FB}$ , PG Voltage.....	-0.3V to 6V
Continuous Total Power Dissipation .....	.....See Thermal Characteristics
Storage Temperature .....	-65°C to +150°C
Operating Junction Temperature.....	-40°C to +125°C
ESD Protection On All Pins:	
HBM .....	3 kV
MM .....	200V

† **Notice:** Stresses above those listed under “Absolute Maximum Ratings” may cause permanent damage to the device. This is a stress rating only and functional operation of the device at those or any other conditions above those indicated in the operational sections of this specification is not intended. Exposure to maximum rating conditions for extended periods may affect device reliability.

### DC CHARACTERISTICS

**Electrical Characteristics:** Unless otherwise indicated,  $T_A = +25^\circ\text{C}$ ,  $V_{IN} = 12\text{V}$ ,  $V_{OUT} = 3.3\text{V}$ ,  $I_{OUT} = 300\text{mA}$ ,  $L = 4.7\ \mu\text{H}$ ,  $C_{OUT} = 2 \times 22\ \mu\text{F}$ ,  $C_{IN} = 2 \times 10\ \mu\text{F}$ . **Boldface** specifications apply over the  $T_J$  range of  $-40^\circ\text{C}$  to  $+125^\circ\text{C}$ .

Parameters	Sym	Min	Typ	Max	Units	Conditions
<b><math>V_{IN}</math> Supply Voltage</b>						
Input Voltage	$V_{IN}$	<b>6.0</b>	—	<b>18</b>	V	
Quiescent Current (Switching)	$I_Q$	—	5.2	—	mA	$I_{OUT} = 0\text{mA}$
Quiescent Current (Non-Switching)	$I_Q$	—	2.3	—	mA	Closed Loop in Overvoltage $I_{OUT} = 0\text{mA}$
Quiescent Current - Shutdown	$I_Q$	—	5	<b>10</b>	$\mu\text{A}$	EN = 0
<b><math>V_{IN}</math> Under Voltage Lockout</b>						
Undervoltage Lockout Start	UVLO <sub>STRT</sub>	<b>5.5</b>	5.75	<b>6.0</b>	V	$V_{IN}$ Rising
Undervoltage Lockout Hysteresis	UVLO <sub>HYS</sub>	—	0.65	—	V	Non-Switching
<b>Output Characteristics</b>						
Maximum Output Current <b>MCP16323</b>	$I_{OUT}$	<b>3</b>	—	—	A	<b>Note 2</b>
Output Voltage Adjust Range	$V_{OUT}$	<b>0.9</b>	—	<b>5.0</b>	V	
Output Voltage Tolerance in PWM Mode	$V_{OUT-PWM}$	<b><math>V_{OUT} - 2\%</math></b>	$V_{OUT}$	<b><math>V_{OUT} + 2\%</math></b>	V	$I_{OUT} = 1\text{A}$
Output Voltage Tolerance in PFM Mode	$V_{OUT-PFM}$	<b><math>V_{OUT} - 1\%</math></b>	$V_{OUT} + 1\%$	<b><math>V_{OUT} + 3.5\%</math></b>	V	$I_{OUT} = 0\text{A}$
Feedback Voltage	$V_{FB}$	<b>0.886</b>	0.9	<b>0.914</b>	V	
Feedback Reference Tolerance	$V_{FB-TOL}$	<b>-1.5</b>	—	<b>1.5</b>	%	

**Note 1:** Regulator SW pin is forced off for 240 ns every 8 cycles to ensure the BOOST cap is replenished.

**2:** As a result of the maximum duty cycle limitations, 3A of output current for 5V output conditions may not regulate the voltage. External component selection may have an impact on this. A minimum input voltage of 6.5V is recommended.

# MCP16323

## DC CHARACTERISTICS (CONTINUED)

<b>Electrical Characteristics:</b> Unless otherwise indicated, $T_A = +25^\circ\text{C}$ , $V_{IN} = 12\text{V}$ , $V_{OUT} = 3.3\text{V}$ , $I_{OUT} = 300\text{ mA}$ , $L = 4.7\ \mu\text{H}$ , $C_{OUT} = 2 \times 22\ \mu\text{F}$ , $C_{IN} = 2 \times 10\ \mu\text{F}$ . <b>Boldface</b> specifications apply over the $T_J$ range of $-40^\circ\text{C}$ to $+125^\circ\text{C}$ .						
Parameters	Sym	Min	Typ	Max	Units	Conditions
PFM Mode Feedback Comparator Threshold	$V_{FB-PFM}$	—	$V_{OUT} + 1\%$	—	V	
Feedback Input Bias Current	$I_{FB}$	—	100	—	nA	
<b>EN Input Characteristics</b>						
EN Input Logic High	$V_{IH}$	<b>2.2</b>	—	—	V	
EN Input Logic Low	$V_{IL}$	—	—	<b>0.8</b>	V	
EN Input Hysteresis	$V_{EN-HYST}$	—	480	—	mV	
EN Input Leakage Current	$I_{ENLK}$	—	3.5	—	$\mu\text{A}$	$V_{EN} = 5\text{V}$
		—	-1.5	—	$\mu\text{A}$	$V_{EN} = 0\text{V}$
Soft-Start Time	$t_{SS}$	—	4	—	ms	
<b>Switching Characteristics</b>						
Switching Frequency	$f_{SW}$	<b>0.9</b>	1	<b>1.1</b>	MHz	Open Loop $V_{FB}$ Low
Maximum Duty Cycle	$DC_{MAX}$	<b>95</b>	97	<b>99</b>	%	Open Loop $V_{FB}$ Low <b>Note 1</b>
Minimum Duty Cycle		—	7	—	%	
NMOS Low-Side Switch On Resistance	Low-Side $R_{DS(ON)}$	—	120	—	$\text{m}\Omega$	
NMOS High-Side Switch On Resistance	High-Side $R_{DS(ON)}$	—	180	—	$\text{m}\Omega$	
NMOS High-Side Switch Current Limit	$I_{N(MAX)}$	<b>3.4</b>	3.8	<b>4.4</b>	A	<b>MCP16323</b>
<b>PG Output Characteristics</b>						
PG Low-level Output Voltage	$PG_{IL}$	—	—	<b>0.01</b>	V	$I_{PG} = -0.3\text{ mA}$
PG High-Level Output Leakage Current	$I_{PGLK}$	—	0.5	—	$\mu\text{A}$	$V_{PG} = 5\text{V}$
PG Release Timer	$t_{PG}$	—	10	—	ms	
$V_{OUT}$ Undervoltage Threshold	$V_{OUT-UV}$	<b>91% <math>V_{OUT}</math></b>	93% $V_{OUT}$	<b>95% <math>V_{OUT}</math></b>		
$V_{OUT}$ Undervoltage Hysteresis	$V_{OUT-UV\_HYST}$	—	1.5% $V_{OUT}$	—		
$V_{OUT}$ Overvoltage Threshold	$V_{OUT-OV}$	—	103% $V_{OUT}$	—		
$V_{OUT}$ Overvoltage Hysteresis	$V_{OUT-OV\_HYST}$	—	1% $V_{OUT}$	—		
<b>Thermal Characteristics</b>						
Thermal Shutdown Die Temperature	$T_{SD}$	—	170	—	$^\circ\text{C}$	
Die Temperature Hysteresis	$T_{SDHYS}$	—	10	—	$^\circ\text{C}$	

**Note 1:** Regulator SW pin is forced off for 240 ns every 8 cycles to ensure the BOOST cap is replenished.

**2:** As a result of the maximum duty cycle limitations, 3A of output current for 5V output conditions may not regulate the voltage. External component selection may have an impact on this. A minimum input voltage of 6.5V is recommended.

**TABLE 1-1: TEMPERATURE CHARACTERISTICS**

Electrical Characteristics						
Parameters	Sym	Min	Typ	Max	Units	Conditions
<b>Temperature Ranges</b>						
Operating Junction Temperature Range	$T_J$	-40	—	125	°C	Steady State
Storage Temperature Range	$T_A$	-65	—	150	°C	
Maximum Junction Temperature	$T_J$	—	—	150	°C	Transient
<b>Package Thermal Resistances</b>						
Thermal Resistance, 16L 3x3-QFN	$\theta_{JA}$	—	38.5	—	°C/W	

**Note 1:** Measured using a 4-layer FR4 Printed Circuit Board with a 13.5 in<sup>2</sup>, 1 oz internal copper ground plane.

# MCP16323

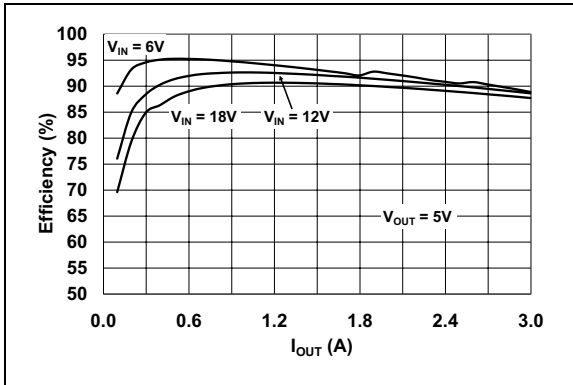
---

NOTES:

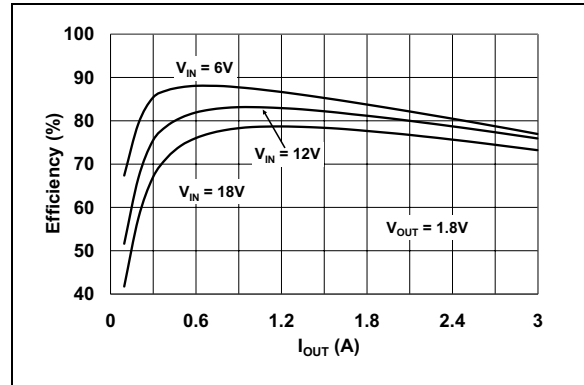
## 2.0 TYPICAL PERFORMANCE CURVES

**Note:** The graphs and tables provided following this note are a statistical summary based on a limited number of samples and are provided for informational purposes only. The performance characteristics listed herein are not tested or guaranteed. In some graphs or tables, the data presented may be outside the specified operating range (e.g., outside specified power supply range) and therefore outside the warranted range.

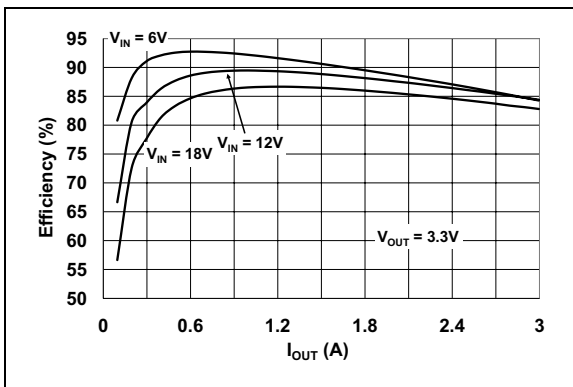
**Note:** Unless otherwise indicated,  $V_{IN} = 12V$ , EN = Floating (internally pulled up),  $C_{IN} = 20 \mu F$ ,  $C_{OUT} = 2 \times 22 \mu F$ ,  $L = 4.7 \mu H$  (XAL6060-472MEB),  $I_{LOAD} = 200 \text{ mA}$ ,  $T_A = +25^\circ C$ .



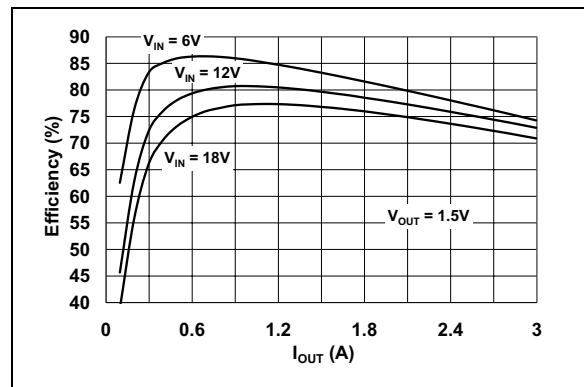
**FIGURE 2-1:** 5V  $V_{OUT}$  Efficiency vs.  $I_{OUT}$ .



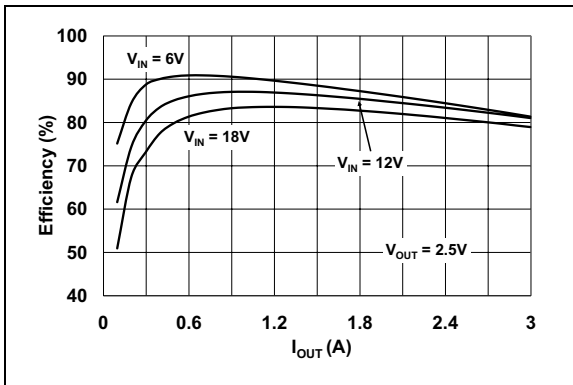
**FIGURE 2-4:** 1.8V  $V_{OUT}$  Efficiency vs.  $I_{OUT}$ .



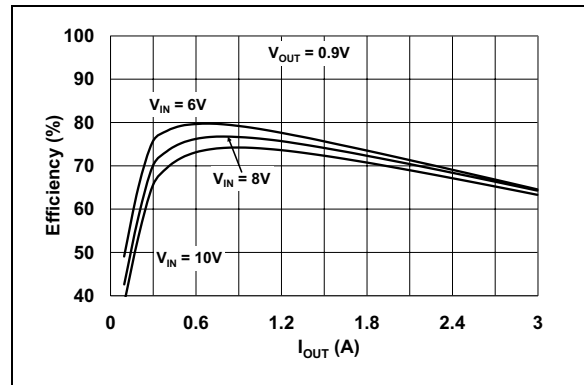
**FIGURE 2-2:** 3.3V  $V_{OUT}$  Efficiency vs.  $I_{OUT}$ .



**FIGURE 2-5:** 1.5V  $V_{OUT}$  Efficiency vs.  $I_{OUT}$ .



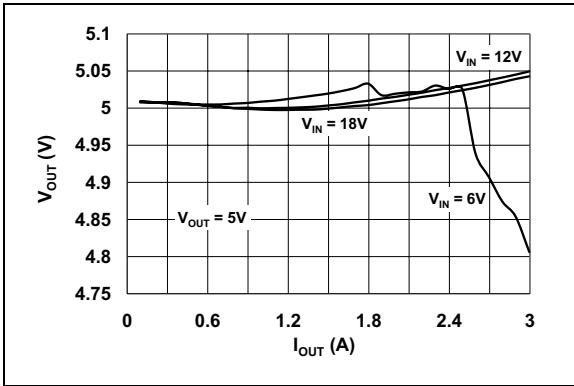
**FIGURE 2-3:** 2.5V  $V_{OUT}$  Efficiency vs.  $I_{OUT}$ .



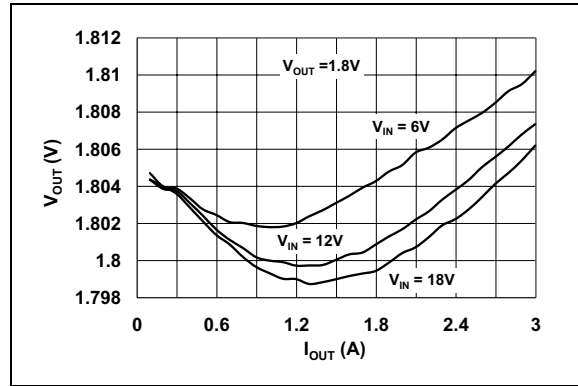
**FIGURE 2-6:** 0.9V  $V_{OUT}$  Efficiency vs.  $I_{OUT}$ .

# MCP16323

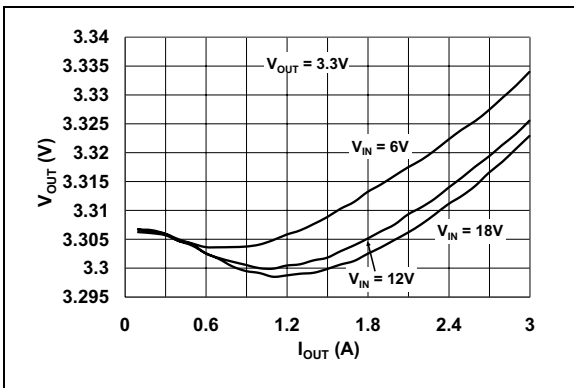
**Note:** Unless otherwise indicated,  $V_{IN} = 12V$ ,  $EN = \text{Floating (internally pulled up)}$ ,  $C_{IN} = 20 \mu F$ ,  $C_{OUT} = 2 \times 22 \mu F$ ,  $L = 4.7 \mu H$ ,  $I_{LOAD} = 200 \text{ mA}$ ,  $T_A = +25^\circ C$ .



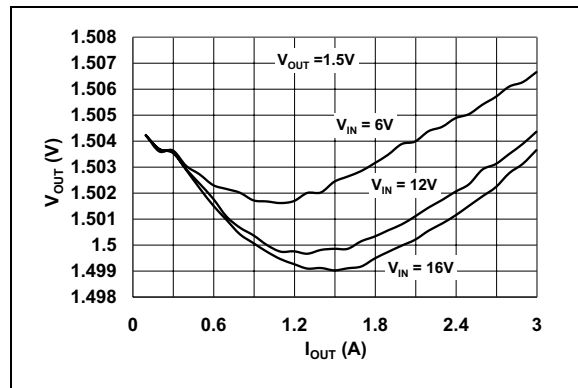
**FIGURE 2-7:** 5V  $V_{OUT}$  vs.  $I_{OUT}$ .



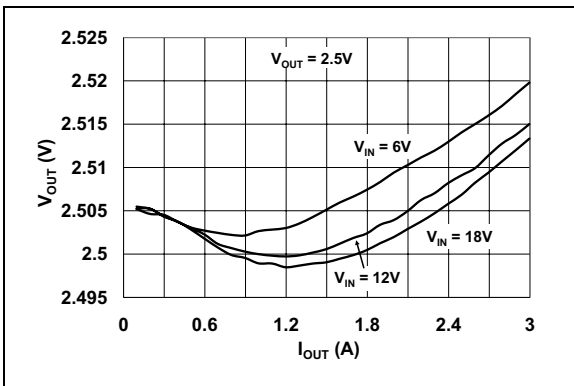
**FIGURE 2-10:** 1.8V  $V_{OUT}$  vs.  $I_{OUT}$ .



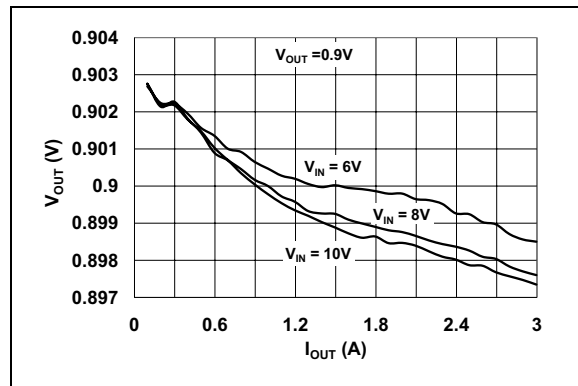
**FIGURE 2-8:** 3.3V  $V_{OUT}$  vs.  $I_{OUT}$ .



**FIGURE 2-11:** 1.5V  $V_{OUT}$  vs.  $I_{OUT}$ .



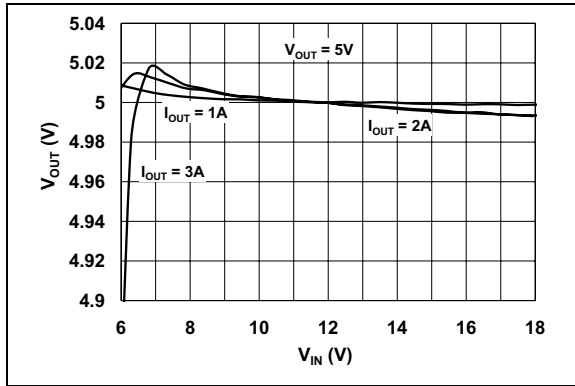
**FIGURE 2-9:** 2.5V  $V_{OUT}$  vs.  $I_{OUT}$ .



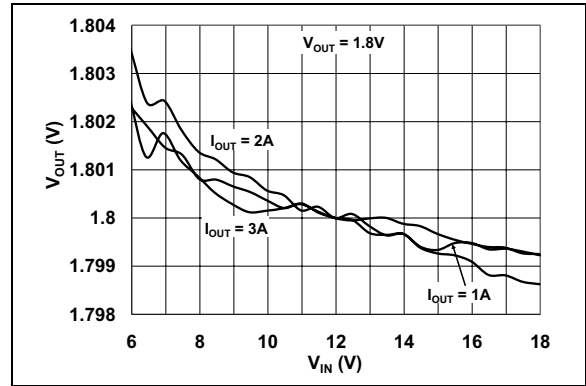
**FIGURE 2-12:** 0.9V  $V_{OUT}$  vs.  $I_{OUT}$ .



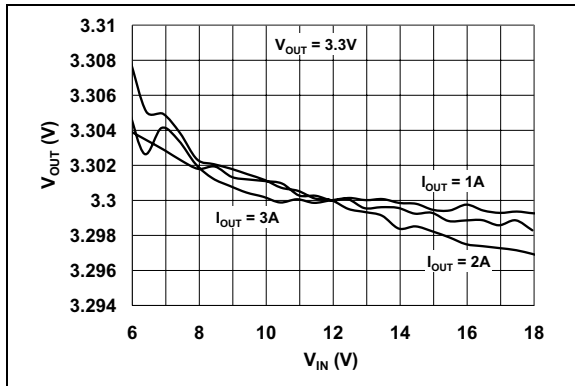
**Note:** Unless otherwise indicated,  $V_{IN} = 12V$ ,  $EN = \text{Floating (internally pulled up)}$ ,  $C_{IN} = 20 \mu F$ ,  $C_{OUT} = 2 \times 22 \mu F$ ,  $L = 4.7 \mu H$ ,  $I_{LOAD} = 200 \text{ mA}$ ,  $T_A = +25^\circ C$ .



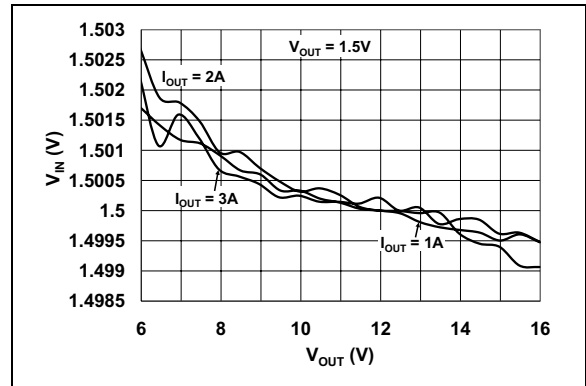
**FIGURE 2-13:** 5V  $V_{OUT}$  vs.  $V_{IN}$ .



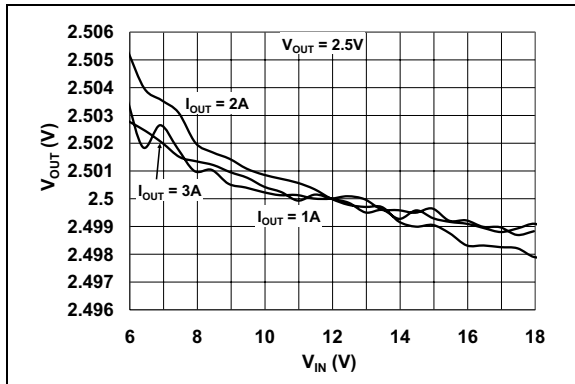
**FIGURE 2-16:** 1.8V  $V_{OUT}$  vs.  $V_{IN}$ .



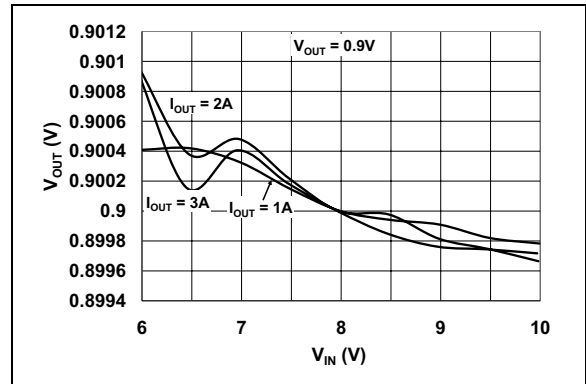
**FIGURE 2-14:** 3.3V  $V_{OUT}$  vs.  $V_{IN}$ .



**FIGURE 2-17:** 1.5V  $V_{OUT}$  vs.  $V_{IN}$ .



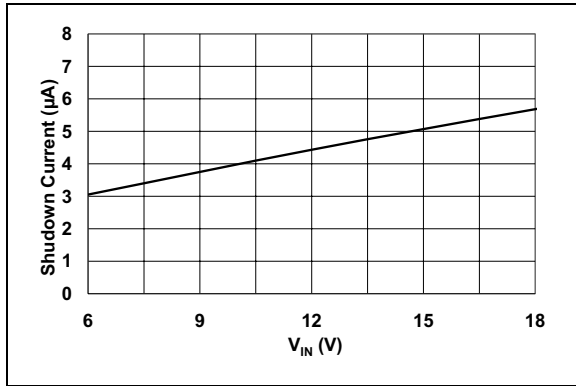
**FIGURE 2-15:** 2.5V  $V_{OUT}$  vs.  $V_{IN}$ .



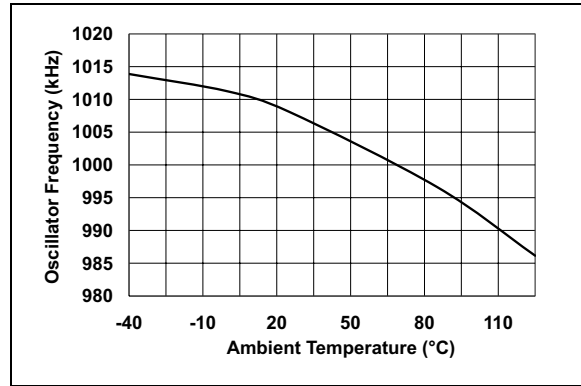
**FIGURE 2-18:** 0.9V  $V_{OUT}$  vs.  $V_{IN}$ .

# MCP16323

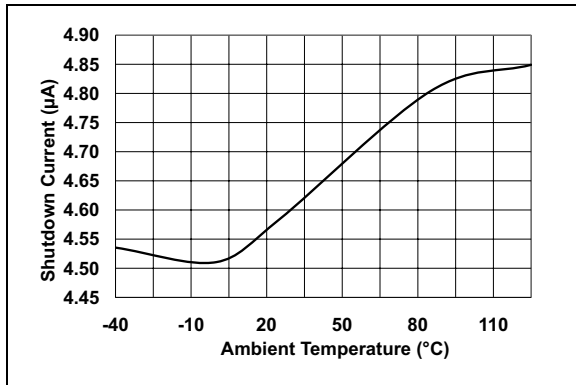
**Note:** Unless otherwise indicated,  $V_{IN} = 12V$ , EN = Floating (internally pulled up),  $C_{IN} = 20 \mu F$ ,  $C_{OUT} = 2 \times 22 \mu F$ ,  $L = 4.7 \mu H$ ,  $I_{LOAD} = 200 \text{ mA}$ ,  $T_A = +25^\circ C$ .



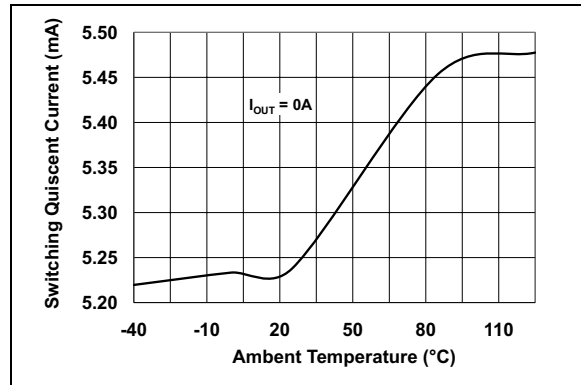
**FIGURE 2-19:** Shutdown Current vs. Input Voltage.



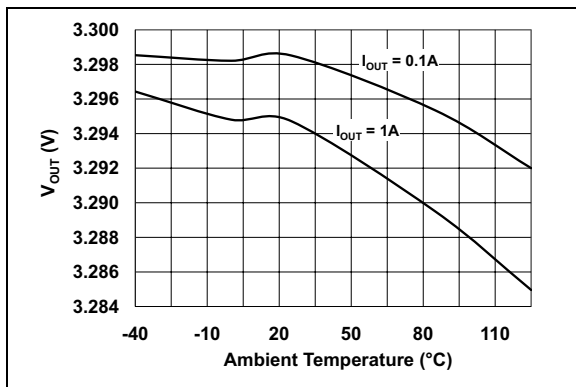
**FIGURE 2-22:** Oscillator Frequency vs. Temperature ( $I_{OUT} = 300 \text{ mA}$ ).



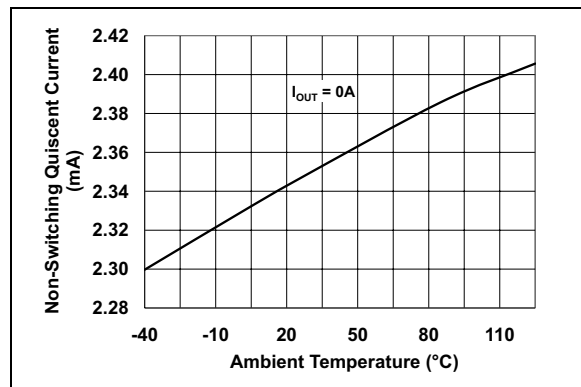
**FIGURE 2-20:** Shutdown Current vs. Temperature.



**FIGURE 2-23:** Input Quiescent Current vs. Temperature (No Load, Switching).

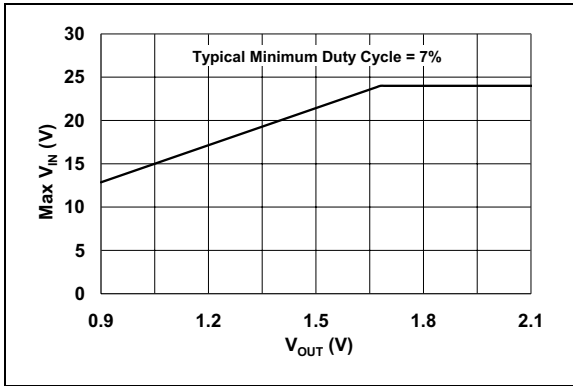


**FIGURE 2-21:** Output Voltage vs. Temperature.

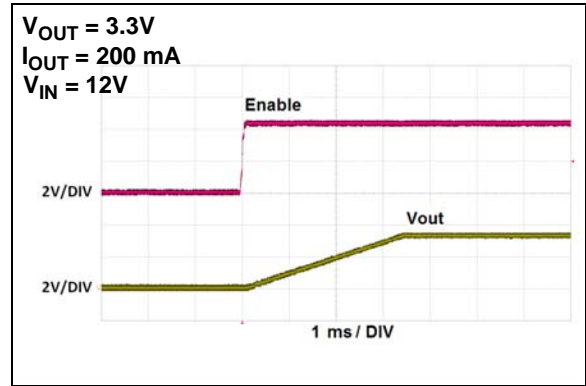


**FIGURE 2-24:** Input Current vs. Temperature (No Load, No Switching).

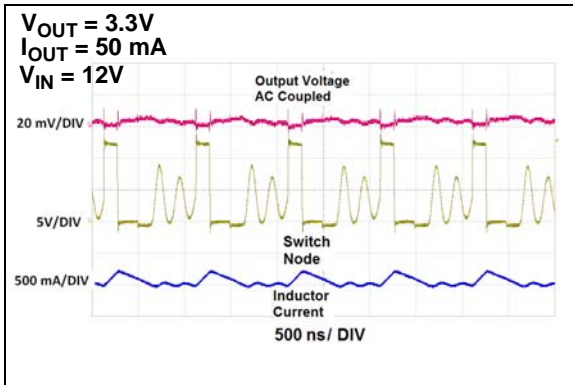
**Note:** Unless otherwise indicated,  $V_{IN} = 12V$ , EN = Floating (internally pulled up),  $C_{IN} = 20 \mu F$ ,  $C_{OUT} = 2 \times 22 \mu F$ ,  $L = 4.7 \mu H$ ,  $I_{LOAD} = 200 \text{ mA}$ ,  $T_A = +25^\circ C$ .



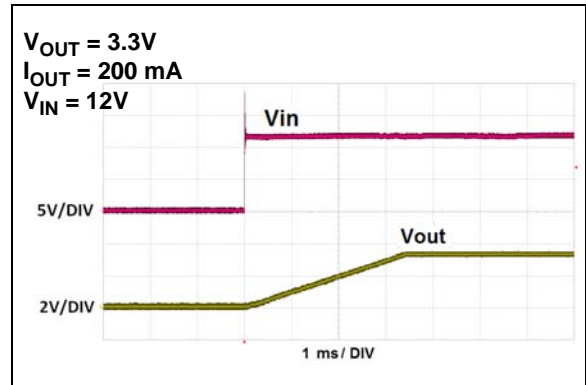
**FIGURE 2-25:** Maximum  $V_{IN}$  to  $V_{OUT}$  Ratio for Continuous Switching.



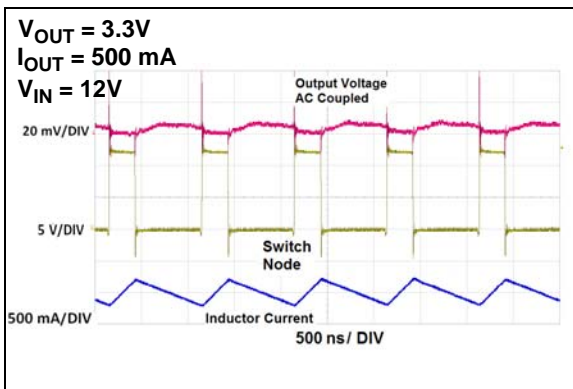
**FIGURE 2-28:** Startup From Enable.



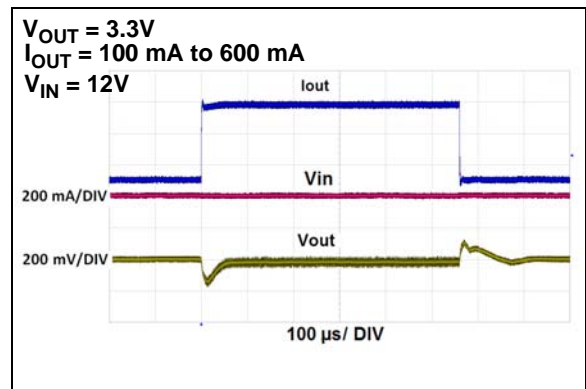
**FIGURE 2-26:** Light Load Switching Waveforms.



**FIGURE 2-29:** Startup From  $V_{IN}$ .



**FIGURE 2-27:** Heavy Load Switching Waveforms.

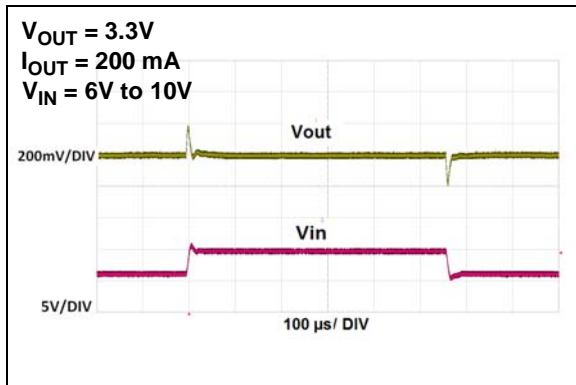


**FIGURE 2-30:** Load Transient Response.

# MCP16323

---

**Note:** Unless otherwise indicated,  $V_{IN} = 12V$ , EN = Floating (internally pulled up),  $C_{IN} = 20 \mu F$ ,  $C_{OUT} = 2 \times 22 \mu F$ ,  $L = 4.7 \mu H$ ,  $I_{LOAD} = 200 \text{ mA}$ ,  $T_A = +25^\circ C$ .



**FIGURE 2-31:** Line Transient Response.

### 3.0 PIN DESCRIPTIONS

The descriptions of the pins are listed in [Table 3-1](#).

**TABLE 3-1: PIN FUNCTION TABLE**

MCP16323 3x3 QFN	Symbol	Description
1	SW	Output switch node, connects to the inductor and the bootstrap capacitor
2	V <sub>IN</sub>	Input supply voltage pin for power and internal biasing
3	V <sub>IN</sub>	Input supply voltage pin for power and internal biasing
4	SGND	Primary signal ground
5	V <sub>FB</sub>	Output voltage feedback pin. Connect V <sub>FB</sub> to V <sub>OUT</sub> for fixed version and output resistor divider for adjustable version.
6	NC	No Connection
7	NC	No Connection
8	PG	Power Good open-drain output, pulled up to a maximum of 6V
9	EN	Enable input pin. Logic high enables the operation. Internally pulled up, pull EN pin low to disable regulator's output. Maximum voltage on EN input is 6V.
10	BOOST	Boost voltage that drives the internal NMOS control switch. A bootstrap capacitor is connected between the BOOST and SW pins.
11	V <sub>IN</sub>	Input supply voltage pin for power and internal biasing
12	SW	Output switch node, connects to the inductor and the bootstrap capacitor
13	SW	Output switch node, connects to the inductor and the bootstrap capacitor
14	PGND	GND supply for the internal low-side NMOS/integrated diode
15	PGND	GND supply for the internal low-side NMOS/integrated diode
16	SW	Output switch node, connects to the inductor and the bootstrap capacitor
17	EP	Exposed Thermal Pad (EP); must be connected to GND

#### 3.1 Switch Pin (SW)

The drain of the low-side N-Channel switch is connected internally to the source of the high-side N-Channel switch, and externally to the SW node consisting of the inductor and bootstrap capacitor. The SW node can rise very fast as a result of the internal high-side switch turning on. It should be connected directly to the 4.7  $\mu$ H inductor with a wide, short trace.

#### 3.2 Power Supply Input Voltage Pin (V<sub>IN</sub>)

Connect the input voltage source to V<sub>IN</sub>. The input source should be decoupled to GND using 2 x 10  $\mu$ F capacitors. The amount of the capacitance depends on the impedance of the source and output current. The input capacitors provide AC current for the high-side power switch and a stable voltage source for the internal device power. This capacitor should be connected as close as possible to the V<sub>IN</sub> and GND pins.

#### 3.3 Signal Ground Pin (S<sub>GND</sub>)

This ground is used for the majority of the device, including the analog reference, control loop, and other circuits.

#### 3.4 Feedback Voltage Pin (V<sub>FB</sub>)

The V<sub>FB</sub> input pin is used to provide output voltage regulation by either using a resistor divider or V<sub>OUT</sub> directly. For the adjustable version, the V<sub>FB</sub> will be 0.9V typical with the output voltage in regulation. For the fixed version, the V<sub>FB</sub> will be equal to the corresponding V<sub>OUT</sub> value.

#### 3.5 Power Good Pin (PG)

PG is an open drain, active low output. The regulator output voltage is monitored and the PG line will remain low until the output voltage reaches the V<sub>OUT-UV</sub> threshold. Once the internal comparator detects that the output voltage is above the V<sub>OUT-UV</sub> threshold, an internal delay timer is activated. After a 10 ms delay, the PG open drain output pin can be pulled high, indicating that the output voltage is in regulation. The maximum voltage applied to the PG output pin should not exceed 6V.

# MCP16323

---

## 3.6 Enable Pin (EN)

The EN input pin is a logic-level input used to enable or disable the device. A logic high ( $> 2.2V$ ) will enable the regulator output, while a logic low ( $< 0.8V$ ) will ensure that the regulator is disabled. This pin is internally pulled up to an internal reference and will be enabled when  $V_{IN} > UVLO$ , unless the EN pin is pulled low. The maximum input voltage applied to the EN pin should not exceed 6V.

## 3.7 BOOST Pin (BOOST)

This pin will provide the bootstrap voltage required for driving the upper internal NMOS switch of the buck regulator. An external ceramic capacitor placed between the BOOST input pin and the SW pin will provide the necessary drive voltage for the upper switch. During steady state operation, the capacitor is recharged on every low-side, synchronous switching cycle. If the Switch mode approaches 100% duty cycle for the high-side MOSFET, the device will automatically reduce the duty cycle switch to a minimum off time of 240 ns on every 8<sup>th</sup> cycle to recharge the boost capacitor.

## 3.8 Power Ground Pin (P<sub>GND</sub>)

This is a separate ground connection used for the low-side synchronous switch to isolate switching noise from the rest of the device.

## 3.9 Exposed Thermal Pad (EP)

There is no internal electrical connection between the Exposed Thermal Pad (EP) and the P<sub>GND</sub> and S<sub>GND</sub> pins. The EP must be connected to GND on the Printed Circuit Board (PCB).

## 4.0 DETAILED DESCRIPTION

### 4.1 Device Overview

The MCP16323 is a high input voltage step-down regulator, capable of supplying 3A to a regulated output voltage from 0.9V to 5V. Internally, the 1 MHz oscillator provides a fixed frequency, while the Peak Current Mode Control architecture varies the duty cycle for output voltage regulation. An internal floating driver is used to turn the high-side integrated N-Channel MOSFET on and off. The power for this driver is derived from an external boost capacitor whose energy is replenished when the low-side N-Channel MOSFET is turned on. When the maximum duty cycle approaches 100%, the boost capacitor is replenished for 240 ns after every 8 cycles.

#### 4.1.1 INTERNAL REFERENCE VOLTAGE $V_{REF}$

For the adjustable version, an integrated precise 0.9V reference combined with an external resistor divider sets the desired converter output voltage. The resistor divider can vary without affecting the control system gain. High-value resistors consume less current, but are more susceptible to noise. For the fixed version, an integrated precise voltage reference is set to the desired  $V_{OUT}$  value and is directly connected to  $V_{OUT}$ .

#### 4.1.2 INTERNAL COMPENSATION

All control system components necessary for stable operation over the entire device operating range are integrated, including the error amplifier and inductor current slope compensation.

#### 4.1.3 EXTERNAL COMPONENTS

External components consist of:

- Input capacitor
- Output filter (inductor and capacitor)
- Boost capacitor
- Resistor divider (adjustable version only)

The selection of the external inductor, output capacitor, input capacitor and boost capacitor is dependent upon the output voltage and the maximum output current.

#### 4.1.4 ENABLE INPUT

The enable input (EN) is used to disable the device. If disabled, the device consumes a minimal current from the input. Once enabled, the internal soft start controls the output voltage rate of rise, preventing high-inrush current and output voltage overshoot. The EN is internally pulled up or enabled, to disable the converter, it must be pulled low.

#### 4.1.5 SOFT START

The internal reference voltage rate of rise is controlled during startup, minimizing the output voltage overshoot and the inrush current.

#### 4.1.6 OUTPUT OVERVOLTAGE PROTECTION

If the output of the regulator exceeds 103% of the regulation voltage, the SW outputs will tri-state to protect the device from damage. This check occurs at the start of each switching cycle.

#### 4.1.7 INPUT UNDER VOLTAGE LOCKOUT

An integrated Under Voltage Lockout (UVLO) prevents the converter from starting until the input voltage is high enough for normal operation. The converter will typically start at 5.75V (typical) and operate down to 5.25V (typical). Hysteresis of 500 mV (typical) is added to prevent starting and stopping during startup, as a result of loading the input voltage source.

#### 4.1.8 MINIMUM DUTY CYCLE

A minimum duty cycle of 70 ns typical prevents the device from constant switching for high step-down voltage ratios. Duty cycles less than this minimum will initiate pulse skipping to maintain output voltage regulation, resulting in higher output voltage ripple. Duty cycle for continuous inductor current operation is approximated by  $V_{OUT}/V_{IN}$ . For a 1 MHz switching frequency or 1  $\mu$ s period, this results in a 7% duty cycle minimum. Maximum  $V_{IN}$  for continuous switching can be approximated dividing  $V_{OUT}$  by the minimum duty cycle or 7%. For example, the maximum input voltage for continuous switching for a 1.5V output is equal to approximately 21V.

# MCP16323

## 4.1.9 OVERTEMPERATURE PROTECTION

Overtemperature protection limits the silicon die temperature to +170°C by turning the converter off. The normal switching resumes at +160°C.

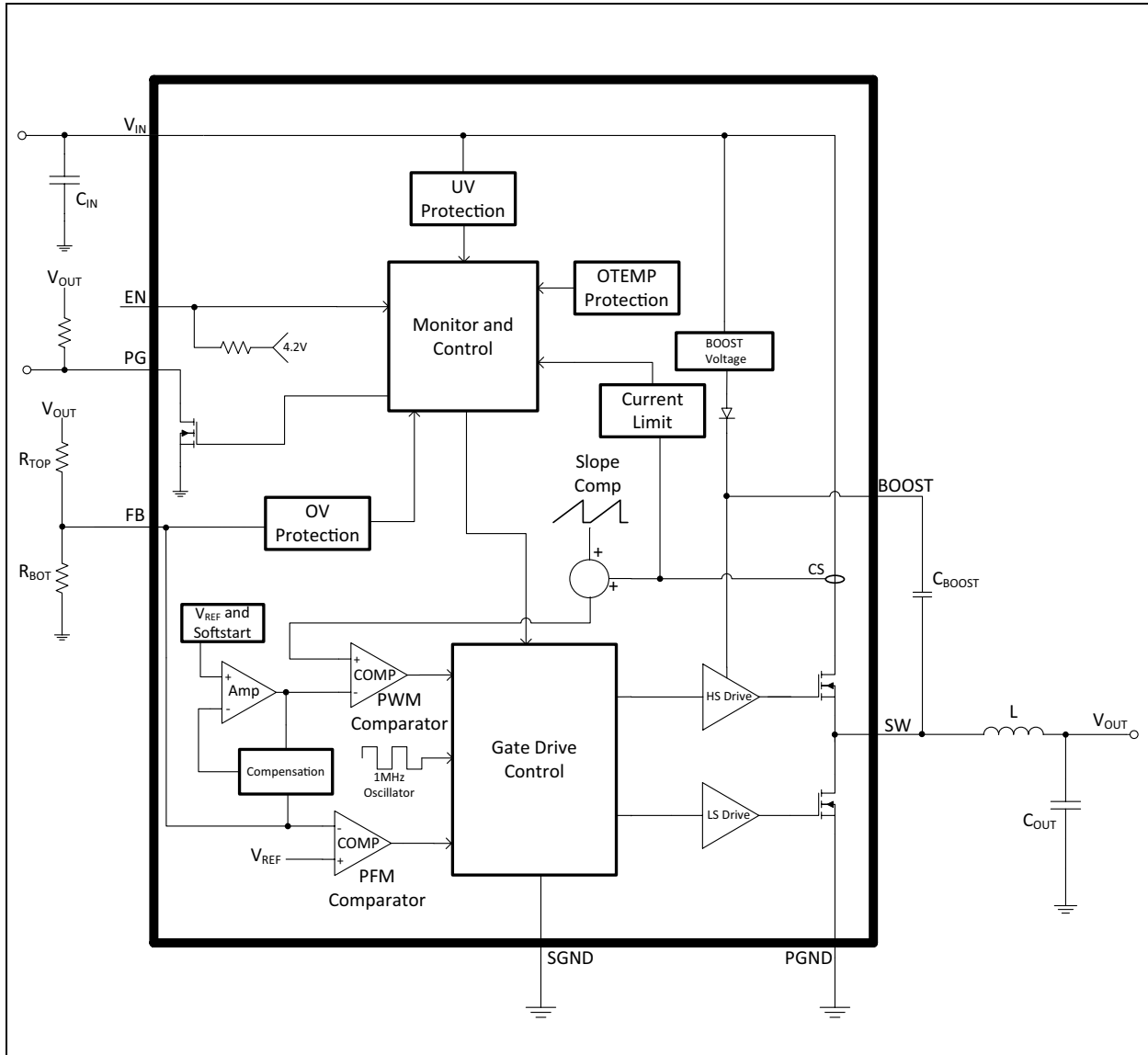


FIGURE 4-1: MCP16323 Block Diagram.



## 4.2 Functional Description

### 4.2.1 STEP-DOWN OR BUCK CONVERTER

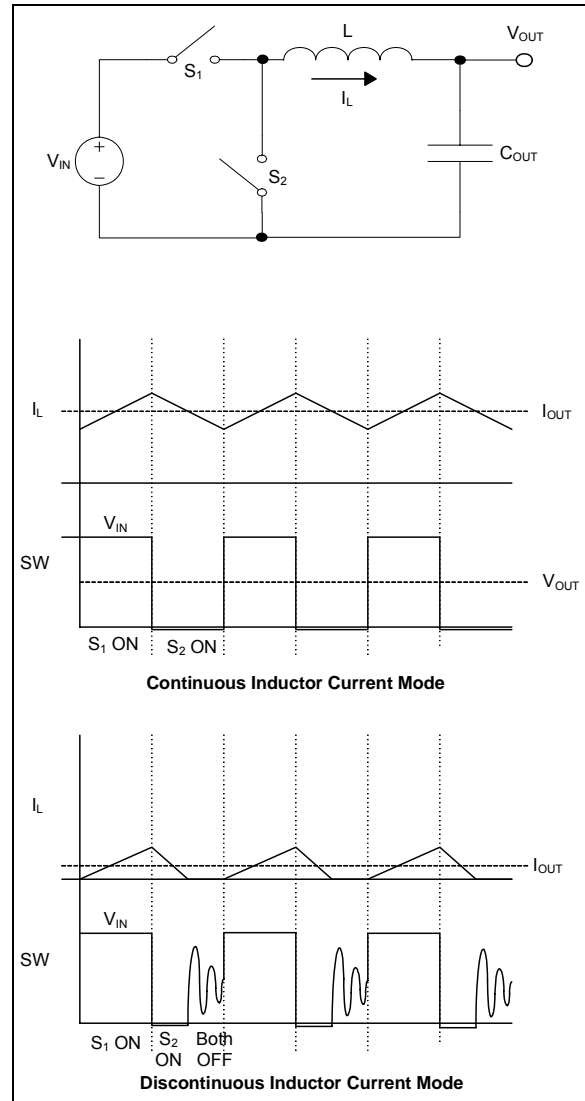
The MCP16323 is a synchronous, step-down or buck converter capable of stepping input voltages ranging from 6V to 18V down to 0.9V to 5V.

The integrated high-side switch is used to chop or modulate the input voltage using a controlled duty cycle for output voltage regulation. The integrated low-side switch is used to freewheel current when the high-side switch is turned off. High efficiency is achieved by using low-resistance switches and low equivalent series resistance (ESR), inductor and capacitors. When the high-side switch is turned on, a DC voltage is applied to the inductor ( $V_{IN} - V_{OUT}$ ), resulting in a positive linear ramp of inductor current. When the high-side switch turns off and the low-side switch turns on, the applied inductor voltage is equal to  $-V_{OUT}$ , resulting in a negative linear ramp of inductor current. In order to ensure there is no shoot through current, a dead time where both switches are off is implemented between the high-side switch turning off and the low-side switch turning on, and the low-side switch turning off and the high-side switch turning on.

For steady-state, continuous inductor current operation, the positive inductor current ramp must equal the negative current ramp in magnitude. While operating in steady state, the switch duty cycle must be equal to the relationship of  $V_{OUT}/V_{IN}$  for constant output voltage regulation, under the condition that the inductor current is continuous, or never reaches zero. For discontinuous inductor current operation, the steady-state duty cycle will be less than  $V_{OUT}/V_{IN}$  to maintain voltage regulation. When the inductor current reaches zero, the low-side switch is turned off so that current does not flow in the reverse direction, keeping the efficiency high. The average of the chopped input voltage or SW node voltage is equal to the output voltage, while the average inductor current is equal to the output current.

### 4.2.2 PEAK CURRENT MODE CONTROL

The MCP16323 integrates a Peak Current Mode Control architecture, resulting in superior AC regulation while minimizing the number of voltage loop compensation components, and their size, for integration. Peak Current Mode Control takes a small portion of the inductor current, replicates it and compares this replicated current sense signal with the output of the integrated error voltage. In practice, the inductor current and the internal switch current are equal during the switch-on time. By adding this peak current sense to the system control, the step-down power train system can be approximated by a 1<sup>st</sup> order system rather than a 2<sup>nd</sup> order system. This reduces the system complexity and increases its dynamic performance.



**FIGURE 4-2:** Synchronous Step-Down Converter.

For Pulse-Width Modulation (PWM) duty cycles that exceed 50%, the control system can become bimodal, where a wide pulse followed by a short pulse repeats instead of the desired fixed pulse width. To prevent this mode of operation, an internal compensating ramp is summed into the current sense signal.

### 4.2.3 PULSE WIDTH MODULATION (PWM)

The internal oscillator periodically starts the switching period, which in the MCP16323's case occurs every 1  $\mu$ s or 1 MHz. With the high-side integrated N-Channel MOSFET turned on, the inductor current ramps up until the sum of the current sense and slope compensation ramp exceeds the integrated error amplifier output. Once this occurs, the high-side switch

# MCP16323

---

turns off and the low-side switch turns on. The error amplifier output slews up or down to increase or decrease the inductor peak current feeding into the output LC filter. If the regulated output voltage is lower than its target, the inverting error amplifier output rises. This results in an increase in the inductor current to correct for errors in the output voltage. The fixed frequency duty cycle is terminated when the sensed inductor peak current, summed with the internal slope compensation, exceeds the output voltage of the error amplifier. The PWM latch is set by turning off the high-side internal switch and preventing it from turning on until the beginning of the next cycle.

## 4.2.4 HIGH-SIDE DRIVE

The MCP16323 features an integrated high-side N-Channel MOSFET for high efficiency step-down power conversion. An N-Channel MOSFET is used for its low resistance and size (instead of a P-Channel MOSFET). The N-Channel MOSFET gate must be driven above its source to fully turn on the device, resulting in a gate-drive voltage above the input to turn on the high-side N-Channel. The high-side N-Channel source is connected to the inductor and boost cap or switch node. When the high-side switch is off and the low-side is on, the inductor current flows through the low-side switch, providing a path to recharge the boost cap from the boost voltage source. An internal boost-blocking diode is used to prevent current flow from the boost cap back into the output during the internal switch-on time. Prior to startup, the boost cap has no stored charge to drive the switch. An internal regulator is used to “pre-charge” the boost cap. Once pre-charged, the switch is turned on and the inductor current flows. When the high-side switch turns off and the low-side turns on, current freewheels through the inductor and low-side switch, providing a path to recharge the boost cap. When the duty cycle approaches its maximum value, there is very little time for the boost cap to be recharged due to the short amount time that the low-side switch is on. Therefore, when the maximum duty cycle approaches, the switch node is forced off for 240 ns every 8 cycles to ensure that the boost cap gets replenished.

## 5.0 APPLICATION INFORMATION

### 5.0.1 TYPICAL APPLICATIONS

The MCP16323 synchronous step-down converter operates over a wide input range, up to 18V maximum. Typical applications include generating a bias or  $V_{DD}$  voltage for PIC<sup>®</sup> microcontrollers, digital control system bias supply for AC-DC converters and 12V industrial input and similar applications.

### 5.0.2 ADJUSTABLE OUTPUT VOLTAGE CALCULATIONS

To calculate the resistor divider values for the MCP16323 adjustable version, use Equation 5-1.  $R_{TOP}$  is connected to  $V_{OUT}$ ,  $R_{BOT}$  is connected to SGND, and both are connected to the  $V_{FB}$  input pin.

#### EQUATION 5-1: RESISTOR DIVIDER CALCULATION

$$V_{OUT} = V_{FB} \times \left( 1 + \frac{R_{TOP}}{R_{BOT}} \right)$$

#### EXAMPLE 5-1: 2.0V RESISTOR DIVIDER

$$\begin{aligned} V_{OUT} &= 2.0V \\ V_{FB} &= 0.9V \\ R_{BOT} &= 10 \text{ k}\Omega \\ R_{TOP} &= 12.2 \text{ k}\Omega \text{ (Standard Value = 12.3 k}\Omega\text{)} \\ V_{OUT} &= 2.007V \text{ (using standard values)} \end{aligned}$$

#### EXAMPLE 5-2: 4.2V RESISTOR DIVIDER

$$\begin{aligned} V_{OUT} &= 4.2V \\ V_{FB} &= 0.9V \\ R_{BOT} &= 10 \text{ k}\Omega \\ R_{TOP} &= 36.7 \text{ k}\Omega \text{ (Standard Value = 36.5 k}\Omega\text{)} \\ V_{OUT} &= 4.185V \text{ (using standard values)} \end{aligned}$$

The error amplifier is internally compensated to ensure loop stability. External resistor dividers, inductance and output capacitance, all have an impact on the control system and should be selected carefully and evaluated for stability. A 10 k $\Omega$  resistor is recommended as a good trade-off for quiescent current and noise immunity.

### 5.0.3 GENERAL DESIGN EQUATIONS

The step-down converter duty cycle can be estimated using Equation 5-2, while operating in Continuous Inductor Current Mode. This equation accounts for the forward drop of two internal N-Channel MOSFETS. As load current increases, the voltage drop in both internal switches will increase, requiring a larger PWM duty cycle to maintain the output voltage regulation. Switch voltage drop is estimated by multiplying the switch current times the switch resistance or  $R_{DS(ON)}$ .

#### EQUATION 5-2: CONTINUOUS INDUCTOR CURRENT DUTY CYCLE

$$D = \frac{V_{OUT} + (I_{LSW} \times R_{DS(ON)L})}{V_{IN} - (I_{HSW} \times R_{DS(ON)H})}$$

### 5.0.4 INPUT CAPACITOR SELECTION

The step-down converter input capacitor must filter the high-input ripple current, as a result of pulsing or chopping the input voltage. The MCP16323 input voltage pin is used to supply voltage for the power train and as a source for internal bias. A low equivalent series resistance (ESR), preferably a ceramic capacitor, is recommended. The necessary capacitance is dependent upon the maximum load current and source impedance. Three capacitor parameters to keep in mind are the voltage rating, equivalent series resistance and the temperature rating. For wide temperature range applications, a multi-layer X7R dielectric is recommended, while for applications with limited temperature range, a multilayer X5R dielectric is acceptable. The input capacitor voltage rating must be  $V_{IN}$  plus margin.

### 5.0.5 OUTPUT CAPACITOR SELECTION

The output capacitor provides a stable output voltage during sudden load transients, and reduces the output voltage ripple. As with the input capacitor, X5R and X7R ceramic capacitors are well suited for this application.

The MCP16323 is internally compensated, so the output capacitance range is limited. See TABLE 5-1: "Capacitor Value Range" for the recommended output capacitor range.

The amount and type of output capacitance and equivalent series resistance will have a significant effect on the output ripple voltage and system stability. The range of the output capacitance is limited due to the integrated compensation of the MCP16323.

The output voltage capacitor rating should be a minimum of  $V_{OUT}$  plus margin.

TABLE 5-1: CAPACITOR VALUE RANGE

Parameter	Min	Max
$C_{IN}$	8 $\mu$ F	None

# MCP16323

**TABLE 5-1: CAPACITOR VALUE RANGE**

Parameter	Min	Max
C <sub>OUT</sub>	33 μF	None

## 5.0.6 INDUCTOR SELECTION

The MCP16323 is designed to be used with small surface mount inductors. Several specifications should be considered prior to selecting an inductor. To optimize system performance, low ESR inductors should be used.

**EQUATION 5-3: INDUCTOR CURRENT RIPPLE**

$$\Delta I_L = \frac{V_L}{L} \times t_{ON}$$

**EXAMPLE 5-3: MCP16323 PEAK INDUCTOR CURRENT – 3A**

$$\begin{aligned} V_{IN} &= 12V \\ V_{OUT} &= 3.3V \\ I_{OUT} &= 3A \\ L &= 4.7 \mu H \end{aligned}$$

$$I_{LPK} = \frac{\Delta I_L}{2} + I_{OUT}$$

Inductor ripple current = 509 mA  
Inductor peak current = 3.255A

An inductor saturation rating minimum of 3.255A is recommended. A trade-off between size, cost and efficiency is made to achieve the desired results.

**TABLE 5-2: MCP16323 RECOMMENDED INDUCTORS**

Part Number	Value (μH)	DCR (Ω)	I <sub>SAT</sub> (A)	Size WxLxH (mm)
<b>Coilcraft®</b>				
MSS6132-472	4.7	0.056	2.84	6.1x6.1x3.2
LPS6225-472	4.7	0.065	3.2	6.2x6.2x2.5
MSS7341-502	4.7	0.024	3.16	7.3x7.3x4.1
DO1813H-472	4.7	0.054	2.6	8.89x6.1x5.0
<b>Würth Elektronik®</b>				
7447785004	4.7	0.06	2.5	5.9x6.2x3.3
7447786004	4.7	0.057	2.8	5.9x6.2x5.1
7447789004	4.7	0.033	3.9	7.3x3.2x1.5
<b>EPCOS®</b>				
B82464G2	4.7	0.033	3.1	10.4x10.4x3.0
B82464A2	4.7	0.03	4.5	10.4x10.4x3.0

## 5.0.7 BOOST CAPACITOR

The boost capacitor is used to supply current for the internal high-side drive circuitry that is above the input voltage. The boost capacitor must store enough energy to completely drive the high-side switch on and off. A 22 nF X5R or X7R capacitor is recommended for all applications. The boost capacitor maximum voltage is 5.5V, so a 6.3V or 10V rated capacitor is recommended.

## 5.0.8 THERMAL CALCULATIONS

The MCP16323 is available in a 3x3 QFN-16 package. By calculating the power dissipation and applying the package thermal resistance (θ<sub>JA</sub>), the junction temperature is estimated. The maximum continuous junction temperature rating for the MCP16323 is +125°C.

To quickly estimate the internal power dissipation for the switching step-down regulator, an empirical calculation using measured efficiency can be used. Given the measured efficiency, the internal power dissipation is estimated in Equation 5-4. This power dissipation includes all internal and external component losses. For a quick internal estimate, subtract the estimated inductor ESR loss from the P<sub>DIS</sub> calculation in Equation 5-4.

**EQUATION 5-4: TOTAL POWER DISSIPATION ESTIMATE**

$$P_{DIS} = \frac{V_{OUT} \times I_{OUT}}{Efficiency} - (V_{OUT} \times I_{OUT})$$

The difference between the first term, input power, and the second term, power delivered, is the total system power dissipation. The inductor losses are estimated by P<sub>L</sub> = I<sub>OUT</sub><sup>2</sup> × L<sub>ESR</sub>.

**EXAMPLE 5-4: POWER DISSIPATION**

$$\begin{aligned} V_{IN} &= 12V \\ V_{OUT} &= 5.0V \\ I_{OUT} &= 3A \\ Efficiency &= 88\% \\ Total\ System\ Dissipation &= 2.05\ W \\ L_{ESR} &= 0.02\ \Omega \\ P_L &= 180\ mW \end{aligned}$$

MCP16323 internal power dissipation estimate:

$$\begin{aligned} P_{DIS} - P_L &= 1.87\ W \\ \theta_{JA} &= 38.5^\circ C/W \\ Estimated\ Junction &= +71.995^\circ C \end{aligned}$$

- Note** 1: θ<sub>JA</sub> = 38.5°C/W for a 4-layer FR4 Printed Circuit Board with a 13.5 in<sup>2</sup>, 1 oz internal copper ground plane.  
2: A smaller ground plane will result in a larger θ<sub>JA</sub> temperature rise.

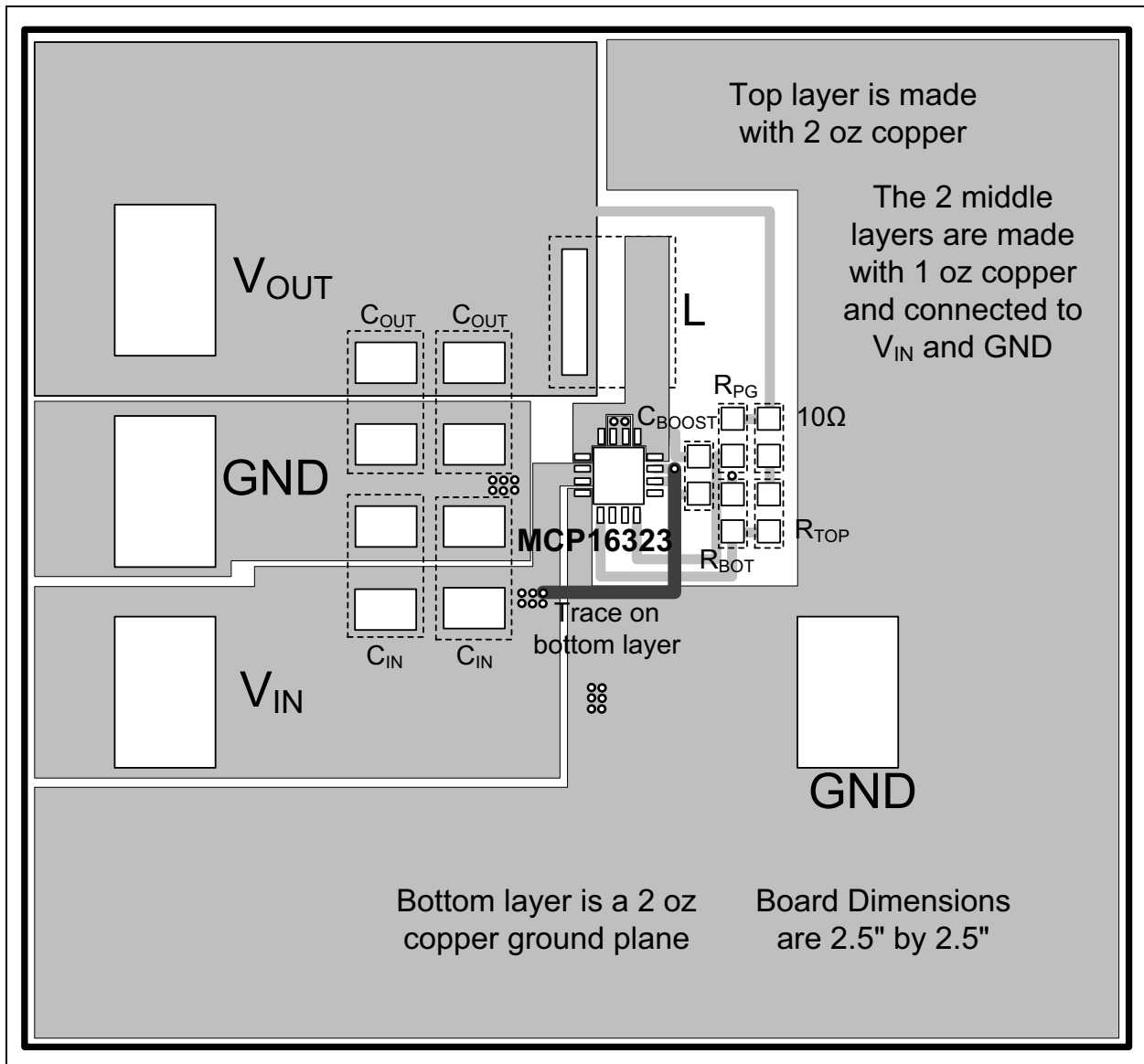
## 5.0.9 PCB LAYOUT INFORMATION

Good printed circuit board layout techniques are important to any switching circuitry, and switching power supplies are no different. When wiring the switching high-current paths, short and wide traces should be used. Therefore, it is important that the input and output capacitors be placed as close as possible to the MCP16323 to minimize the loop area.

The feedback resistors and feedback signal should be routed away from the switching node and the switching current loop. When possible, ground planes and traces should be used to help shield the feedback signal and minimize noise and magnetic interference.

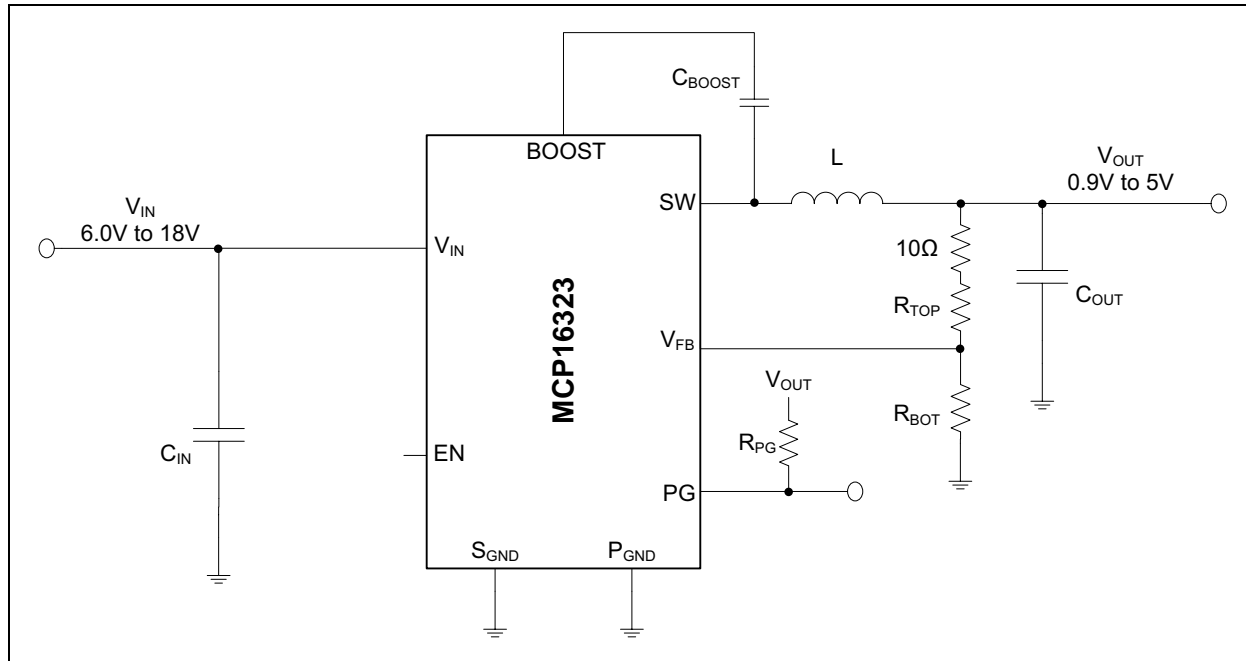
A good MCP16323 layout starts with  $C_{IN}$  placement.  $C_{IN}$  supplies current to the input of the circuit when the switch is turned on. In addition to supplying high-

frequency switch current,  $C_{IN}$  also provides a stable voltage source for the internal MCP16323 circuitry. Unstable PWM operation can result if there are excessive transients or ringing on the  $V_{IN}$  pin of the MCP16323 device. In [Figure 5-1](#),  $C_{IN}$  is placed close to the  $V_{IN}$  pins. A ground plane on the bottom of the board provides a low resistive and low inductive path for the return current. The next priority in placement is the freewheeling current loop formed by  $C_{OUT}$  and  $L$  while strategically placing the  $C_{OUT}$  return close to  $C_{IN}$  return. Next,  $C_{BOOST}$  should be placed between the boost pin and the switch node pin. This leaves space close to the MCP16323  $V_{FB}$  pin to place  $R_{TOP}$  and  $R_{BOT}$ .  $R_{TOP}$  and  $R_{BOT}$  are routed away from the switch node so noise is not coupled into the high-impedance  $V_{FB}$  input.



**FIGURE 5-1:** Recommended Layout.

# MCP16323



**FIGURE 5-2:** Recommended Layout – Schematic.

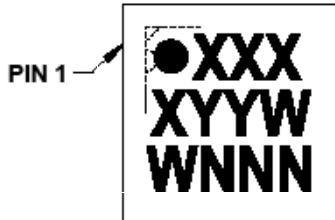
**TABLE 5-3: RECOMMENDED LAYOUT COMPONENTS**

Component	Value
$C_{IN}$	2 x 10 $\mu$ F
$C_{OUT}$	2 x 22 $\mu$ F
L	4.7 $\mu$ H
$R_{TOP}$	36.5 k $\Omega$
$R_{BOT}$	10 k $\Omega$
$R_{PG}$	10 k $\Omega$
$C_{BOOST}$	22 nF

## 6.0 PACKAGING INFORMATION

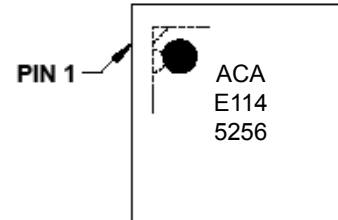
### 6.1 Package Marking Information

16-Lead QFN (3x3x0.9 mm)



Part Number	Code
MCP16323T-150E/NG	ACA
MCP16323T-180E/NG	ACB
MCP16323T-250E/NG	ACC
MCP16323T-330E/NG	ACD
MCP16323T-500E/NG	ACE
MCP16323T-ADJE/NG	ACF

Example

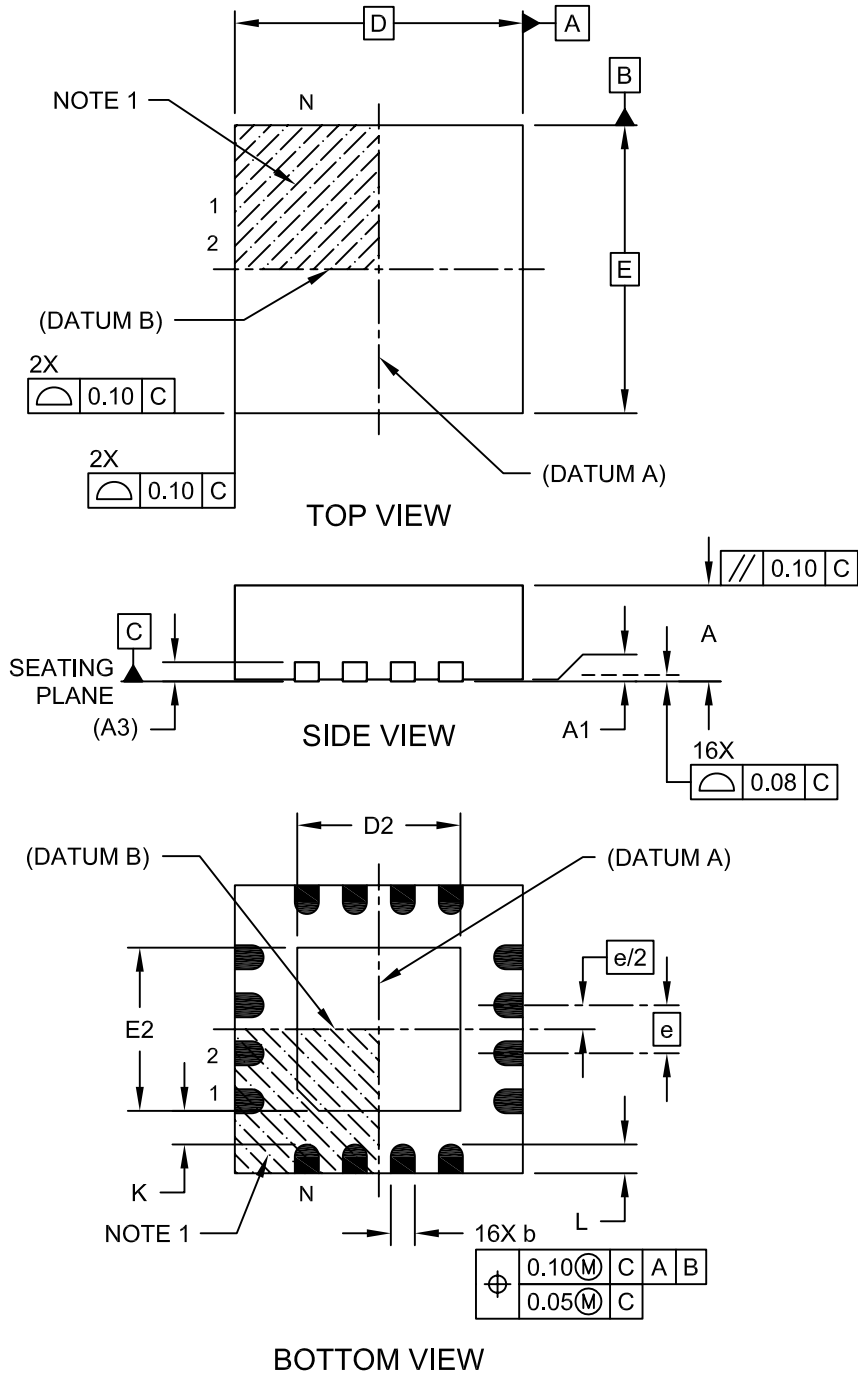


<b>Legend:</b>	XX...X	Customer-specific information
	Y	Year code (last digit of calendar year)
	YY	Year code (last 2 digits of calendar year)
	WW	Week code (week of January 1 is week '01')
	NNN	Alphanumeric traceability code
	(e3)	Pb-free JEDEC designator for Matte Tin (Sn)
	*	This package is Pb-free. The Pb-free JEDEC designator (e3) can be found on the outer packaging for this package.
<b>Note:</b>	In the event the full Microchip part number cannot be marked on one line, it will be carried over to the next line, thus limiting the number of available characters for customer-specific information.	

# MCP16323

## 16-Lead Plastic Quad Flat, No Lead Package (NG) - 3x3x0.9 mm Body [QFN]

**Note:** For the most current package drawings, please see the Microchip Packaging Specification located at <http://www.microchip.com/packaging>

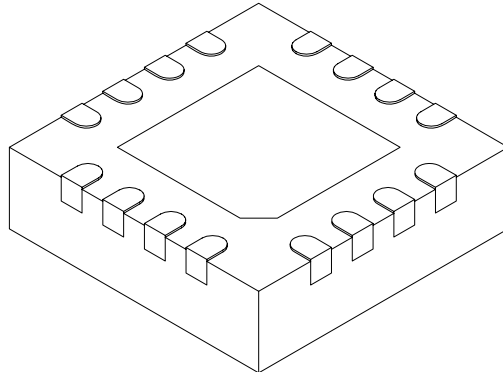


Microchip Technology Drawing C04-197A Sheet 1 of 2



## 16-Lead Plastic Quad Flat, No Lead Package (NG) - 3x3x0.9 mm Body [QFN]

**Note:** For the most current package drawings, please see the Microchip Packaging Specification located at <http://www.microchip.com/packaging>



		MILLIMETERS		
Units				
Dimension Limits		MIN	NOM	MAX
Number of Pins	N	16		
Pitch	e	0.50 BSC		
Overall Height	A	0.80	0.90	1.00
Standoff	A1	0.00	0.02	0.05
Terminal Thickness	A3	0.20 REF		
Overall Width	E	3.00 BSC		
Exposed Pad Width	E2	1.55	1.70	1.80
Overall Length	D	3.00 BSC		
Exposed Pad Length	D2	1.55	1.70	1.80
Terminal Width	b	0.18	0.25	0.30
Terminal Length	L	0.20	0.30	0.40
Terminal-to-Exposed Pad	K	0.20	-	-

**Notes:**

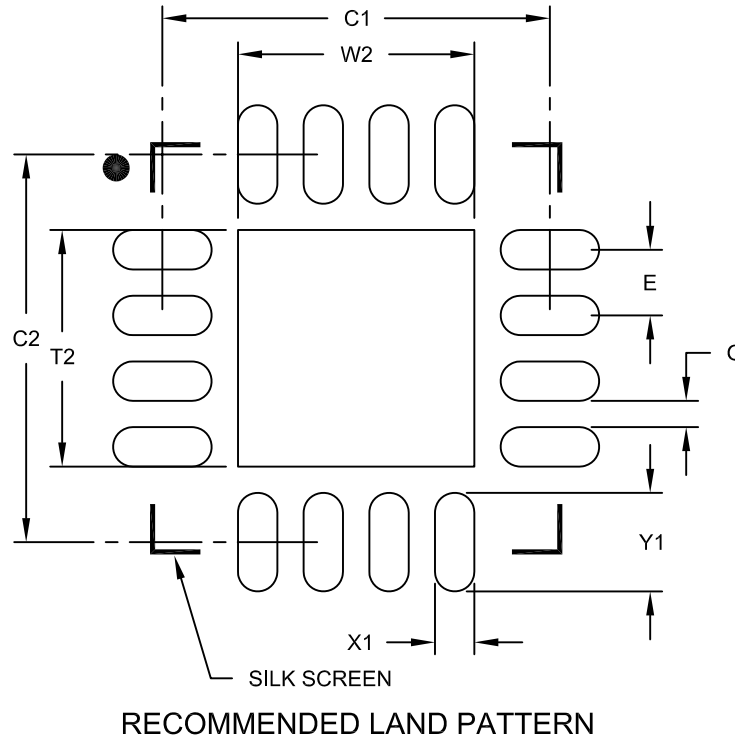
- Pin 1 visual index feature may vary, but must be located within the hatched area.
- Package is saw singulated.
- Dimensioning and tolerancing per ASME Y14.5M.
  - BSC: Basic Dimension. Theoretically exact value shown without tolerances.
  - REF: Reference Dimension, usually without tolerance, for information purposes only.

Microchip Technology Drawing C04-197A Sheet 2 of 2

# MCP16323

16-Lead Plastic Quad Flat, No Lead Package (NG) – 3x3x0.9 mm Body [QFN]

**Note:** For the most current package drawings, please see the Microchip Packaging Specification located at <http://www.microchip.com/packaging>



Dimension Limits	Units	MILLIMETERS		
		MIN	NOM	MAX
Contact Pitch	E	0.50 BSC		
Optional Center Pad Width	W2			1.80
Optional Center Pad Length	T2			1.80
Contact Pad Spacing	C1		2.95	
Contact Pad Spacing	C2		2.95	
Contact Pad Width (X16)	X1			0.30
Contact Pad Length (X16)	Y1			0.75
Distance Between Pads	G	0.20		

Notes:

1. Dimensioning and tolerancing per ASME Y14.5M

BSC: Basic Dimension. Theoretically exact value shown without tolerances.

Microchip Technology Drawing No. C04-2197A

## APPENDIX A: REVISION HISTORY

### Revision A (December 2011)

- Original Release of this Document.

# MCP16323

---

NOTES:

## PRODUCT IDENTIFICATION SYSTEM

To order or obtain information, e.g., on pricing or delivery, refer to the factory or the listed sales office.

<u>PART NO.</u>	<u>I</u>	<u>-XXX</u>	<u>X</u>	<u>/XX</u>
Device	Tape and Reel	Output Voltage	Temperature Range	Package
Device:	MCP16323T:	High-Efficiency Synchronous Buck Regulator (Tape and Reel) (QFN)		
Output Voltage	150 = 1.5V 180 = 1.8V 250 = 2.5V 330 = 3.3V 500 = 5.0V ADJ = Adjustable			
Temperature Range:	E = -40°C to +125°C			
Package:	NG = Plastic Quad Flat, No Lead Package (3x3x0.9 mm Body) (QFN), 16-lead			

### Examples:

- a) MCP16323T-150E/NG: Tape and Reel, 1.5V Output Voltage, Extended Temperature, 16LD QFN Package
- b) MCP16323T-ADJE/NG: Tape and Reel, Adjustable Output Voltage, Extended Temperature, 16LD QFN Package

# MCP16323

---

NOTES:

---

**Note the following details of the code protection feature on Microchip devices:**

- Microchip products meet the specification contained in their particular Microchip Data Sheet.
- Microchip believes that its family of products is one of the most secure families of its kind on the market today, when used in the intended manner and under normal conditions.
- There are dishonest and possibly illegal methods used to breach the code protection feature. All of these methods, to our knowledge, require using the Microchip products in a manner outside the operating specifications contained in Microchip's Data Sheets. Most likely, the person doing so is engaged in theft of intellectual property.
- Microchip is willing to work with the customer who is concerned about the integrity of their code.
- Neither Microchip nor any other semiconductor manufacturer can guarantee the security of their code. Code protection does not mean that we are guaranteeing the product as “unbreakable.”

Code protection is constantly evolving. We at Microchip are committed to continuously improving the code protection features of our products. Attempts to break Microchip's code protection feature may be a violation of the Digital Millennium Copyright Act. If such acts allow unauthorized access to your software or other copyrighted work, you may have a right to sue for relief under that Act.

---

Information contained in this publication regarding device applications and the like is provided only for your convenience and may be superseded by updates. It is your responsibility to ensure that your application meets with your specifications. MICROCHIP MAKES NO REPRESENTATIONS OR WARRANTIES OF ANY KIND WHETHER EXPRESS OR IMPLIED, WRITTEN OR ORAL, STATUTORY OR OTHERWISE, RELATED TO THE INFORMATION, INCLUDING BUT NOT LIMITED TO ITS CONDITION, QUALITY, PERFORMANCE, MERCHANTABILITY OR FITNESS FOR PURPOSE. Microchip disclaims all liability arising from this information and its use. Use of Microchip devices in life support and/or safety applications is entirely at the buyer's risk, and the buyer agrees to defend, indemnify and hold harmless Microchip from any and all damages, claims, suits, or expenses resulting from such use. No licenses are conveyed, implicitly or otherwise, under any Microchip intellectual property rights.

**Trademarks**

The Microchip name and logo, the Microchip logo, dsPIC, KEELOQ, KEELOQ logo, MPLAB, PIC, PICmicro, PICSTART, PIC<sup>32</sup> logo, rPIC and UNI/O are registered trademarks of Microchip Technology Incorporated in the U.S.A. and other countries.


FilterLab, Hampshire, HI-TECH C, Linear Active Thermistor, MXDEV, MXLAB, SEEVAL and The Embedded Control Solutions Company are registered trademarks of Microchip Technology Incorporated in the U.S.A.

Analog-for-the-Digital Age, Application Maestro, chipKIT, chipKIT logo, CodeGuard, dsPICDEM, dsPICDEM.net, dsPICworks, dsSPEAK, ECAN, ECONOMONITOR, FanSense, HI-TIDE, In-Circuit Serial Programming, ICSP, Mindi, MiWi, MPASM, MPLAB Certified logo, MPLIB, MPLINK, mTouch, Omniscient Code Generation, PICC, PICC-18, PICDEM, PICDEM.net, PICKit, PICtail, REAL ICE, rLAB, Select Mode, Total Endurance, TSHARC, UniWinDriver, WiperLock and ZENA are trademarks of Microchip Technology Incorporated in the U.S.A. and other countries.

SQTP is a service mark of Microchip Technology Incorporated in the U.S.A.

All other trademarks mentioned herein are property of their respective companies.

© 2011, Microchip Technology Incorporated, Printed in the U.S.A., All Rights Reserved.

 Printed on recycled paper.

ISBN: 978-1-61341-866-6

**QUALITY MANAGEMENT SYSTEM**  
**CERTIFIED BY DNV**  
**== ISO/TS 16949:2009 ==**

*Microchip received ISO/TS-16949:2009 certification for its worldwide headquarters, design and wafer fabrication facilities in Chandler and Tempe, Arizona; Gresham, Oregon and design centers in California and India. The Company's quality system processes and procedures are for its PIC<sup>®</sup> MCUs and dsPIC<sup>®</sup> DSCs, KEELOQ<sup>®</sup> code hopping devices, Serial EEPROMs, microperipherals, nonvolatile memory and analog products. In addition, Microchip's quality system for the design and manufacture of development systems is ISO 9001:2000 certified.*



# MICROCHIP

## Worldwide Sales and Service

### AMERICAS

**Corporate Office**  
2355 West Chandler Blvd.  
Chandler, AZ 85224-6199  
Tel: 480-792-7200  
Fax: 480-792-7277  
Technical Support:  
<http://www.microchip.com/support>  
Web Address:  
[www.microchip.com](http://www.microchip.com)

**Atlanta**  
Duluth, GA  
Tel: 678-957-9614  
Fax: 678-957-1455

**Boston**  
Westborough, MA  
Tel: 774-760-0087  
Fax: 774-760-0088

**Chicago**  
Itasca, IL  
Tel: 630-285-0071  
Fax: 630-285-0075

**Cleveland**  
Independence, OH  
Tel: 216-447-0464  
Fax: 216-447-0643

**Dallas**  
Addison, TX  
Tel: 972-818-7423  
Fax: 972-818-2924

**Detroit**  
Farmington Hills, MI  
Tel: 248-538-2250  
Fax: 248-538-2260

**Indianapolis**  
Noblesville, IN  
Tel: 317-773-8323  
Fax: 317-773-5453

**Los Angeles**  
Mission Viejo, CA  
Tel: 949-462-9523  
Fax: 949-462-9608

**Santa Clara**  
Santa Clara, CA  
Tel: 408-961-6444  
Fax: 408-961-6445

**Toronto**  
Mississauga, Ontario,  
Canada  
Tel: 905-673-0699  
Fax: 905-673-6509

### ASIA/PACIFIC

**Asia Pacific Office**  
Suites 3707-14, 37th Floor  
Tower 6, The Gateway  
Harbour City, Kowloon  
Hong Kong  
Tel: 852-2401-1200  
Fax: 852-2401-3431

**Australia - Sydney**  
Tel: 61-2-9868-6733  
Fax: 61-2-9868-6755

**China - Beijing**  
Tel: 86-10-8569-7000  
Fax: 86-10-8528-2104

**China - Chengdu**  
Tel: 86-28-8665-5511  
Fax: 86-28-8665-7889

**China - Chongqing**  
Tel: 86-23-8980-9588  
Fax: 86-23-8980-9500

**China - Hangzhou**  
Tel: 86-571-2819-3187  
Fax: 86-571-2819-3189

**China - Hong Kong SAR**  
Tel: 852-2401-1200  
Fax: 852-2401-3431

**China - Nanjing**  
Tel: 86-25-8473-2460  
Fax: 86-25-8473-2470

**China - Qingdao**  
Tel: 86-532-8502-7355  
Fax: 86-532-8502-7205

**China - Shanghai**  
Tel: 86-21-5407-5533  
Fax: 86-21-5407-5066

**China - Shenyang**  
Tel: 86-24-2334-2829  
Fax: 86-24-2334-2393

**China - Shenzhen**  
Tel: 86-755-8203-2660  
Fax: 86-755-8203-1760

**China - Wuhan**  
Tel: 86-27-5980-5300  
Fax: 86-27-5980-5118

**China - Xian**  
Tel: 86-29-8833-7252  
Fax: 86-29-8833-7256

**China - Xiamen**  
Tel: 86-592-2388138  
Fax: 86-592-2388130

**China - Zhuhai**  
Tel: 86-756-3210040  
Fax: 86-756-3210049

### ASIA/PACIFIC

**India - Bangalore**  
Tel: 91-80-3090-4444  
Fax: 91-80-3090-4123

**India - New Delhi**  
Tel: 91-11-4160-8631  
Fax: 91-11-4160-8632

**India - Pune**  
Tel: 91-20-2566-1512  
Fax: 91-20-2566-1513

**Japan - Osaka**  
Tel: 81-66-152-7160  
Fax: 81-66-152-9310

**Japan - Yokohama**  
Tel: 81-45-471-6166  
Fax: 81-45-471-6122

**Korea - Daegu**  
Tel: 82-53-744-4301  
Fax: 82-53-744-4302

**Korea - Seoul**  
Tel: 82-2-554-7200  
Fax: 82-2-558-5932 or  
82-2-558-5934

**Malaysia - Kuala Lumpur**  
Tel: 60-3-6201-9857  
Fax: 60-3-6201-9859

**Malaysia - Penang**  
Tel: 60-4-227-8870  
Fax: 60-4-227-4068

**Philippines - Manila**  
Tel: 63-2-634-9065  
Fax: 63-2-634-9069

**Singapore**  
Tel: 65-6334-8870  
Fax: 65-6334-8850

**Taiwan - Hsin Chu**  
Tel: 886-3-5778-366  
Fax: 886-3-5770-955

**Taiwan - Kaohsiung**  
Tel: 886-7-536-4818  
Fax: 886-7-330-9305

**Taiwan - Taipei**  
Tel: 886-2-2500-6610  
Fax: 886-2-2508-0102

**Thailand - Bangkok**  
Tel: 66-2-694-1351  
Fax: 66-2-694-1350

### EUROPE

**Austria - Wels**  
Tel: 43-7242-2244-39  
Fax: 43-7242-2244-393

**Denmark - Copenhagen**  
Tel: 45-4450-2828  
Fax: 45-4485-2829

**France - Paris**  
Tel: 33-1-69-53-63-20  
Fax: 33-1-69-30-90-79

**Germany - Munich**  
Tel: 49-89-627-144-0  
Fax: 49-89-627-144-44

**Italy - Milan**  
Tel: 39-0331-742611  
Fax: 39-0331-466781

**Netherlands - Drunen**  
Tel: 31-416-690399  
Fax: 31-416-690340

**Spain - Madrid**  
Tel: 34-91-708-08-90  
Fax: 34-91-708-08-91

**UK - Wokingham**  
Tel: 44-118-921-5869  
Fax: 44-118-921-5820

11/29/11



## X-ON Electronics

Largest Supplier of Electrical and Electronic Components

*Click to view similar products for [Switching Controllers](#) category:*

*Click to view products by [Microchip](#) manufacturer:*

Other Similar products are found below :

[LV5065VB-TLM-H](#) [LV5066V-TLM-H](#) [LV5725JAZ-AH](#) [633888R](#) [MP2908AGF](#) [AZ7500EP-E1](#) [NCP1012AP133G](#) [NCP1217P133G](#)  
[NCP1218AD65R2G](#) [NCP1234AD100R2G](#) [NCP1244BD065R2G](#) [NCP1336ADR2G](#) [NCP1587GDR2G](#) [NCP6153MNTWG](#)  
[NCP81005MNTWG](#) [NCP81101BMNTXG](#) [NCP81205MNTXG](#) [HV9123NG-G-M934](#) [IR35207MTRPBF](#) [ISL6367HIRZ](#) [CAT874-80ULGT3](#)  
[SJ6522AG](#) [SJE6600](#) [TLE63893GV50XUMA1](#) [IR35215MTRPBF](#) [SG3845DM](#) [NCP1216P133G](#) [NCP1236DD65R2G](#) [NCP1247BD100R2G](#)  
[NCP1250BP65G](#) [NCP4202MNR2G](#) [NCP4204MNTXG](#) [NCP6132AMNR2G](#) [NCP81141MNTXG](#) [NCP81142MNTXG](#) [NCP81172MNTXG](#)  
[NCP81203MNTXG](#) [NCP81206MNTXG](#) [NX2155HCUPTR](#) [UC3845ADM](#) [UBA2051C](#) [IR35201MTRPBF](#) [MAX8778ETJ+](#)  
[MAX17500AAUB+T](#) [MAX17411GTM+T](#) [MAX16933ATIR/V+](#) [NCP1010AP130G](#) [NCP1063AD100R2G](#) [NCP1216AP133G](#)  
[NCP1217AP100G](#)