

●Features

- 1) Full line up from ultra small size (01005) to 2512 with jumper type.
- 2) ROHM resistors have obtained ISO9001/ISO/TS16949 certification.



Part No.	Size		Type Code	Packing Specification	Quantity / Reel
	(mm)	(inch)			
MCR006	0603	0201	YRT	Paper tape (2mm pitch)	15,000
MCR01	1005	0402	MRT		10,000
MCR03	1608	0603	ERT	Paper tape (4mm pitch)	5,000
MCR10	2012	0805			
MCR18	3216	1206			
MCR25	3225	1210	JRT	Embossed tape (4mm pitch)	4,000
MCR50	5025	2010			
MCR100	6432	2512			

●Part Number Description

M C R	0 0 6	Y R T	J	1 0 0						
Part No.	Size (mm [inch])	Type Code	Resistance Tolerance	Nominal Resistance						
MCR (Micro chip resistors)	006 (0603 [0201]) 01 (1005 [0402]) 03 (1608 [0603]) 10 (2012 [0805]) 18 (3216 [1206]) 25 (3225 [1210]) 50 (5025 [2010]) 100 (6432 [2512])		D (±0.5%) F (±1%) J (±5%) (Including jumper type)	Resistance code, 3 or 4 digits. 000 denotes jumper type. <table border="1" style="width: 100%;"> <tr> <th>Resistance tolerance</th> <th>Resistance code</th> </tr> <tr> <td>D,F</td> <td>: 4 digits</td> </tr> <tr> <td>J</td> <td>: 3 digits</td> </tr> </table>	Resistance tolerance	Resistance code	D,F	: 4 digits	J	: 3 digits
Resistance tolerance	Resistance code									
D,F	: 4 digits									
J	: 3 digits									
Ex.) 1Ω = 1R0 (±5%) 9.1Ω = 9R1 (±5%) 10Ω = 10R0 (±0.5%, ±1%) 100 (±5%) 2.2MΩ = 2204 (±1%) 225 (±5%)										

●Products List

Part No.	Type Code	Rated Power (70°C) (W)	Limiting Element Voltage (V)	Temperature Coefficient (ppm / °C)	Resistance Tolerance (%)	Resistance Range	Series	Operating Temperature Range (°C)
MCR006	YRT	0.05	25	+600 / -200 ±250	J(±5%)	1.0Ω to 9.1Ω 10Ω to 10MΩ	E24	-55 to +125
				±250	F(±1%)	10Ω to 10MΩ		
				±200 ±100	D(±0.5%)	10Ω to 910Ω 1kΩ to 1MΩ		
Jumper type : Rmax = 50m Ω / Imax. = 0.5A								
MCR01	MRT	0.063	50	+500 / -250 ±200	J(±5%)	1.0Ω to 9.1Ω 10Ω to 10MΩ	E24	
				±100	F(±1%)	10Ω to 976kΩ 10Ω to 2.2MΩ 1MΩ to 2.2MΩ	E24,E96	
				±100 ±50	D(±0.5%)	10Ω to 91Ω 100Ω to 1MΩ	E24	
Jumper type : Rmax = 50m Ω / Imax. = 1A								
MCR03	ERT	0.1	50	±400 ±200	J(±5%)	1.0Ω to 9.1Ω 10Ω to 10MΩ	E24	
				±100	F(±1%)	10Ω to 976kΩ 10Ω to 10MΩ 1MΩ to 10MΩ	E24,E96	
				±100 ±50	D(±0.5%)	10Ω to 91Ω 100Ω to 1MΩ	E24	
Jumper type : Rmax = 50m Ω / Imax. = 1A								
MCR10	ERT	0.125	150	±400 ±200	J(±5%)	1.0Ω to 9.1Ω 10Ω to 10MΩ	E24	
				±100	F(±1%)	10Ω to 976kΩ 10Ω to 2.2MΩ 1MΩ to 2.2MΩ	E24,E96	
		0.1		±100 ±50	D(±0.5%)	10Ω to 91Ω 100Ω to 1MΩ	E24	
Jumper type : Rmax = 50m Ω / Imax. = 2A								
MCR18	ERT	0.25	200	±400 ±200	J(±5%)	1.0Ω to 9.1Ω 10Ω to 10MΩ	E24	
				±100	F(±1%)	10Ω to 976kΩ 10Ω to 2.2MΩ 1MΩ to 2.2MΩ	E24,E96	
		0.125		±100 ±50	D(±0.5%)	10Ω to 91Ω 100Ω to 1MΩ	E24	
Jumper type : Rmax = 50m Ω / Imax. = 2A								
MCR25	JRT	0.25	200	±200 ±100	J(±5%)	1.0Ω to 9.1Ω 10Ω to 3.3MΩ	E24	
				±100	F(±1%)	10Ω to 1MΩ	E24,E96	
				Jumper type : Rmax = 50m Ω / Imax. = 2A				
MCR50	JRT	0.5	200	±250 ±100	J(±5%)	1.0Ω to 9.1Ω 10Ω to 560kΩ	E24	
				±100	F(±1%)	10Ω to 180kΩ	E24,E96	
				Jumper type : Rmax = 50m Ω / Imax. = 2A				
MCR100	JRT	1	200	±250 ±100	J(±5%)	1.0Ω to 9.1Ω 10Ω to 100kΩ	E24	-55 to +125
				±100	F(±1%)	10Ω to 82kΩ	E24,E96	
				Jumper type : Rmax = 50m Ω / Imax. =2A				

*Design and specifications are subject to change without notice. Carefully check the specification sheet supplied with the product before using or ordering it.

*Rated voltage is determined from the following.

When rated voltage exceeds the limiting element voltage, the limiting element voltage shall be the rated voltage.

*Rated voltage = $\sqrt{\text{Rated power} \times \text{Resistance}}$

●Chip Resistor Dimensions and Markings

■ MCR006 / 01 / 03 ■ MCR10 / 18 / 25 / 50 / 100

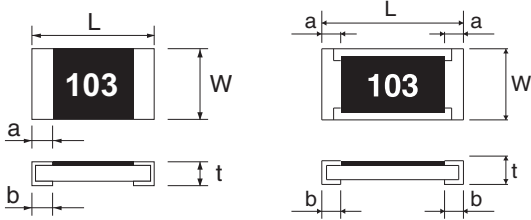

<Marking method>

There are three or four digits used for the calculation number according to IEC code and "R" is used for the decimal point.

(Unit : mm)

Part No.	Type Code	(mm)	(inch)	L	W	t	a	b	Marking existence
MCR006	YRT	0603	0201	0.6±0.03	0.3±0.03	0.23±0.03	0.15±0.05	0.15±0.05	No
MCR01	MRT	1005	0402	1.0±0.05	0.5±0.05	0.35±0.05	0.2±0.1	0.25 ^{+0.05} _{-0.1}	No
MCR03	ERT	1608	0603	1.6±0.1	0.8±0.1	0.45±0.1	0.3±0.2	0.3±0.2	Yes *
MCR10	ERT	2012	0805	2.0±0.1	1.25±0.1	0.5±0.1	0.35±0.2	0.35±0.2	Yes
MCR18	ERT	3216	1206	3.05±0.15	1.55±0.15	0.55±0.1	0.45±0.25	0.35±0.25	Yes
MCR25	JRT	3225	1210	3.2±0.15	2.5±0.15	0.55±0.15	0.5±0.25	0.5±0.25	Yes
MCR50	JRT	5025	2010	5.0±0.15	2.5±0.15	0.55±0.15	0.6±0.25	0.6±0.25	Yes
MCR100	JRT	6432	2512	6.3±0.15	3.2±0.15	0.55±0.15	0.6±0.25	0.6±0.25	Yes

Marking method of jumper type

Jumper type	Marking existence
MCR006 / 01 / 25 / 50 / 100	No
MCR03 / 10 / 18	Yes

*Marking method of MCR03

The description of markings on the chip resistor are as shown below.

① Marking method (J class):

The nominal resistance is expressed in by E-24series 3 digits. The first 2 digits apply to the resistance value and the last one indicates the number of zeros to follow. The R is used as a decimal point.

Example : 100kΩ = 104

② Marking method (F/D class):

·For the resistance value contained in E96 series.

The nominal resistance is expressed in 3 digits. The first 2 digits is symbol to the resistance value and the last one is symbol to multipliers.

Example : 100kΩ = 01d (01d→100 × 10³ = 100,000Ω = 100kΩ)

Example : 3.01kΩ = 47b (47b→301 × 10¹ = 3010Ω = 3.01kΩ)

·For the resistance value not contained in E96 series and contained in E-24 series.

The marking is expressed by E-24 series in 3 digits and one short bar under the last marking letter.

Example : 390Ω = 391̄

Symbol for E96 Series nominal resistance value

Symbol	E96	Symbol	E96	Symbol	E96	Symbol	E96
01	100	25	178	49	316	73	562
02	102	26	182	50	324	74	576
03	105	27	187	51	332	75	590
04	107	28	191	52	340	76	604
05	110	29	196	53	348	77	619
06	113	30	200	54	357	78	634
07	115	31	205	55	365	79	649
08	118	32	210	56	374	80	665
09	121	33	215	57	383	81	681
10	124	34	221	58	392	82	698
11	127	35	226	59	402	83	715
12	130	36	232	60	412	84	732
13	133	37	237	61	422	85	750
14	137	38	243	62	432	86	768
15	140	39	249	63	442	87	787
16	143	40	255	64	453	88	806
17	147	41	261	65	464	89	825
18	150	42	267	66	475	90	845
19	154	43	274	67	487	91	866
20	158	44	280	68	499	92	887
21	162	45	287	69	511	93	909
22	165	46	294	70	523	94	931
23	169	47	301	71	536	95	953
24	174	48	309	72	549	96	976

Symbol for multipliers

Symbol	A	b	C	d	E	F	X	Y
multipliers	10 ⁰	10 ¹	10 ²	10 ³	10 ⁴	10 ⁵	10 ⁻¹	10 ⁻²

●Land pattern Example

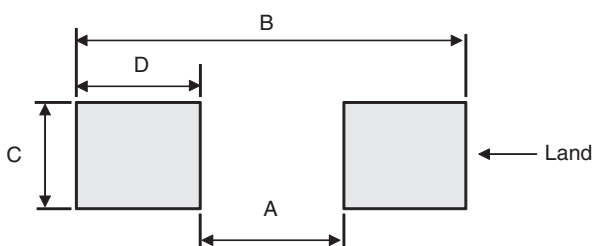

(Unit : mm)

Part No.	Type Code	A	B	C	D
MCR006	YRT	0.3	0.84	0.3	0.27
MCR01	MRT	0.5	1.3	0.5	0.4
MCR03	ERT	1.0	2.0	0.8	0.5
MCR10	ERT	1.2	2.6	1.15	0.7
MCR18	ERT	2.2	4.0	1.5	0.9
MCR25	JRT	2.2	4.0	2.3	0.9
MCR50	JRT	3.8	6.0	2.3	1.1
MCR100	JRT	5.1	8.1	3.0	1.5

●Derating Curve

When the ambient temperature exceeds 70°C, power dissipation must be adjusted according to the derating curves below.

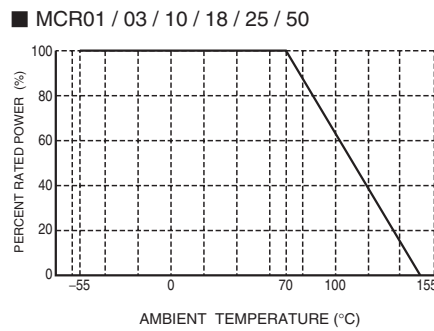
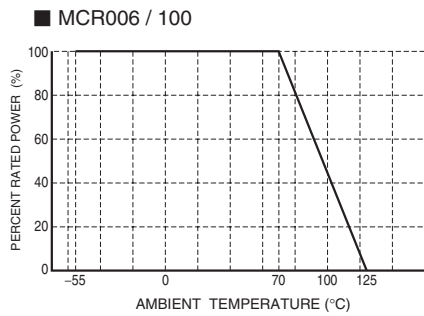

●Characteristics

Test Items	Guaranteed Value		Test Conditions
	Resistor Type	Jumper Type	
Resistance	See "Products List"		20°C
Variation of resistance with temperature	See "Products List"		Measurement : +20 / -55 / +20 / +125°C
Overload	± (2.0%+0.1Ω)	Max. 50mΩ	Test voltage is the smaller one of ① or ② ① Rated voltage (current) ×2.5, 2s. ② Maximum overload voltage
Solderability	A new uniform coating of minimum of 95% of the surface being immersed and no soldering damage.		Rosin-Ethanol : 25% (Weight) Soldering condition : 235±5°C Duration of immersion : 2.0±0.5s
Resistance to soldering heat	± (1.0%+0.05Ω) No remarkable abnormality on the appearance.	Max. 50mΩ	Soldering condition : 260±5°C Duration of immersion : 10±1s
Rapid change of temperature	± (1.0%+0.05Ω)	Max. 50mΩ	Test temp. -55°C to +125°C 100cycle (MCR006) -55°C to +125°C 300cycle (MCR01) -55°C to +125°C 5cycle (MCR03 / 10 / 18 / 25 / 50 / 100)
Damp heat, steady state	± (3.0%+0.1Ω)	Max. 100mΩ	40°C, 93%RH (Relative Humidity) Test time : 1,000h to 1,048h
Endurance at 70°C	± (3.0%+0.1Ω)	Max. 100mΩ	70°C Rated voltage (current) 1.5h : ON – 0.5h : OFF Test time : 1,000h to 1,048h
Endurance	± (3.0%+0.1Ω)	Max. 100mΩ	125°C (MCR006 / 25 / 50 / 100) 155°C (MCR01 / 03 / 10 / 18) Test time : 1,000h to 1,048h
Resistance to solvent	± (1.0%+0.05Ω)	Max. 50mΩ	23±5°C, Immersion cleaning, 5±0.5min Solvent : 2-propanol
Bend strength of the end face plating	± (1.0%+0.05Ω) Without mechanical damage such as breaks.	Max. 50mΩ	-

Maximum overload voltage *Test voltage

MCR006	MCR01	MCR03	MCR10	MCR18	MCR025	MCR50	MCR100
50V	100V	100V	200V	400V	400V	400V	400V

Compliance Standard(s) : IEC60115-8
JISC 5201-8

●Tape Dimensions

(Unit : mm)

■ Paper Tape

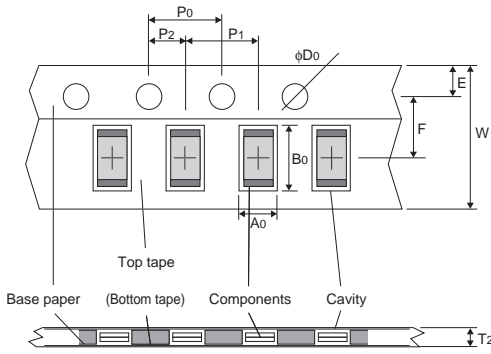

Part No.	Type Code	W	F	E	A0	B0
MCR006	YRT	8.0±0.2	3.5±0.05	1.75±0.1	0.38±0.03	0.68±0.03
MCR01	MRT	8.0±0.3	3.5±0.05	1.75±0.1	0.7±0.1	1.2±0.1
MCR03	ERT	8.0±0.3	3.5±0.05	1.75±0.1	1.0±0.1	1.8±0.1
MCR10	ERT	8.0±0.3	3.5±0.05	1.75±0.1	1.55±0.1	2.3±0.1
MCR18	ERT	8.0±0.3	3.5±0.05	1.75±0.1	1.9±0.2	3.5±0.2
MCR25	JRT	8.0±0.2	3.5±0.05	1.75±0.1	2.8±0.2	3.5±0.2

Part No.	Type Code	D0	P0	P1	P2	T2
MCR006	YRT	φ1.5 ^{+0.1} / ₀	4.0±0.1	2.0±0.05	2.0±0.05	Max 0.5
MCR01	MRT	φ1.5 ^{+0.1} / ₀	4.0±0.1	2.0±0.1	2.0±0.05	Max 1.1
MCR03	ERT	φ1.5 ^{+0.1} / ₀	4.0±0.1	4.0±0.1	2.0±0.05	Max 1.1
MCR10	ERT	φ1.5 ^{+0.1} / ₀	4.0±0.1	4.0±0.1	2.0±0.05	Max 1.1
MCR18	ERT	φ1.5 ^{+0.1} / ₀	4.0±0.1	4.0±0.1	2.0±0.05	Max 1.1
MCR25	JRT	φ1.5 ^{+0.1} / ₀	4.0±0.05	4.0±0.1	2.0±0.05	Max 1.1

■ Embossed Tape
<MCR25 / 50 / 100>

(Unit : mm)

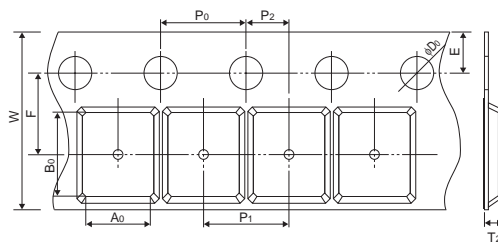

Part No.	Type Code	W	F	E	A0	B0
MCR25	JRT	8.0±0.3	3.5±0.05	1.75±0.1	3.0±0.1	3.5±0.1
MCR50	JRT	12±0.3	5.5±0.05	1.75±0.1	3.4±0.2	5.6±0.2
MCR100	JRT	12±0.3	5.5±0.05	1.75±0.1	3.5±0.2	6.7±0.2

Part No.	Type Code	D0	P0	P1	P2	T2
MCR25	JRT	φ1.5 ^{+0.1} / ₀	4.0±0.1	4.0±0.1	2.0±0.05	Max 1.1
MCR50	JRT	φ1.5 ^{+0.1} / ₀	4.0±0.1	4.0±0.1	2.0±0.05	Max 1.1
MCR100	JRT	φ1.5 ^{+0.1} / ₀	4.0±0.1	4.0±0.1	2.0±0.05	Max 1.1

●Reel Dimensions

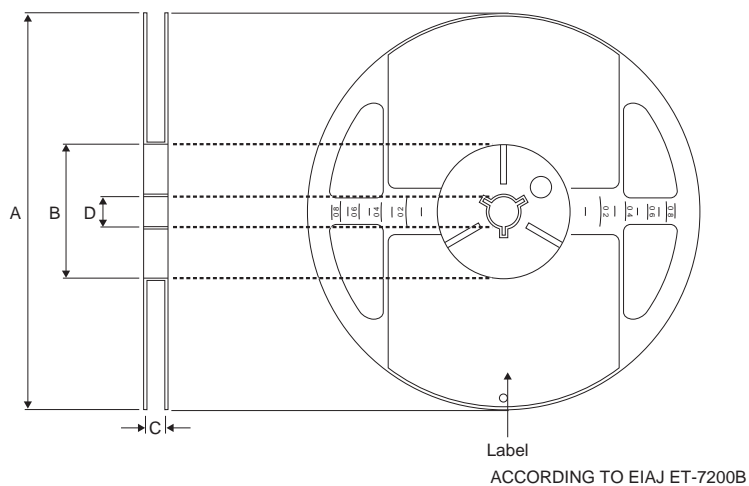

(Unit : mm)

Part No.	Type Code	A	B	C	D
MCR006	YRT	$\phi 180 \begin{matrix} 0 \\ -1.5 \end{matrix}$	$\phi 60 \begin{matrix} +1.0 \\ 0 \end{matrix}$	$9 \begin{matrix} +1.0 \\ 0 \end{matrix}$	$\phi 13 \pm 0.2$
MCR01	MRT				
MCR03	ERT				
MCR10	ERT				
MCR18	ERT			$13 \begin{matrix} +1.0 \\ 0 \end{matrix}$	
MCR25	JRT				
MCR50	JRT				
MCR100	JRT				

Notes

- 1) The information contained herein is subject to change without notice.
- 2) Before you use our Products, please contact our sales representative and verify the latest specifications :
- 3) Although ROHM is continuously working to improve product reliability and quality, semiconductors can break down and malfunction due to various factors.
Therefore, in order to prevent personal injury or fire arising from failure, please take safety measures such as complying with the derating characteristics, implementing redundant and fire prevention designs, and utilizing backups and fail-safe procedures. ROHM shall have no responsibility for any damages arising out of the use of our Products beyond the rating specified by ROHM.
- 4) Examples of application circuits, circuit constants and any other information contained herein are provided only to illustrate the standard usage and operations of the Products. The peripheral conditions must be taken into account when designing circuits for mass production.
- 5) The technical information specified herein is intended only to show the typical functions of and examples of application circuits for the Products. ROHM does not grant you, explicitly or implicitly, any license to use or exercise intellectual property or other rights held by ROHM or any other parties. ROHM shall have no responsibility whatsoever for any dispute arising out of the use of such technical information.
- 6) The Products are intended for use in general electronic equipment (i.e. AV/OA devices, communication, consumer systems, gaming/entertainment sets) as well as the applications indicated in this document.
- 7) The Products specified in this document are not designed to be radiation tolerant.
- 8) For use of our Products in applications requiring a high degree of reliability (as exemplified below), please contact and consult with a ROHM representative : transportation equipment (i.e. cars, ships, trains), primary communication equipment, traffic lights, fire/crime prevention, safety equipment, medical systems, servers, solar cells, and power transmission systems.
- 9) Do not use our Products in applications requiring extremely high reliability, such as aerospace equipment, nuclear power control systems, and submarine repeaters.
- 10) ROHM shall have no responsibility for any damages or injury arising from non-compliance with the recommended usage conditions and specifications contained herein.
- 11) ROHM has used reasonable care to ensure the accuracy of the information contained in this document. However, ROHM does not warrant that such information is error-free, and ROHM shall have no responsibility for any damages arising from any inaccuracy or misprint of such information.
- 12) Please use the Products in accordance with any applicable environmental laws and regulations, such as the RoHS Directive. For more details, including RoHS compatibility, please contact a ROHM sales office. ROHM shall have no responsibility for any damages or losses resulting from non-compliance with any applicable laws or regulations.
- 13) When providing our Products and technologies contained in this document to other countries, you must abide by the procedures and provisions stipulated in all applicable export laws and regulations, including without limitation the US Export Administration Regulations and the Foreign Exchange and Foreign Trade Act.
- 14) This document, in part or in whole, may not be reprinted or reproduced without prior consent of ROHM.



Thank you for your accessing to ROHM product informations.
More detail product informations and catalogs are available, please contact us.

ROHM Customer Support System

<http://www.rohm.com/contact/>

X-ON Electronics

Largest Supplier of Electrical and Electronic Components

Click to view similar products for [Thick Film Resistors](#) category:

Click to view products by [ROHM](#) manufacturer:

Other Similar products are found below :

[MCR03EZPFX3162](#) [MCR004YZPJ332](#) [201007J022KT4E](#) [201007F1653T4E](#) [201007F6652T4E](#) [0603WAF137KT5E](#) [RTT204702FTE](#)
[RTT203000FTE](#) [RTT2056R0FTE](#) [CR2010F470KE04Z](#) [RTT018451FTH](#) [RTT021802DTH](#) [0402WGF510LTCE](#) [0201WMJ0200TEE](#)
[TR0603B26K7P0550Z](#) [0201WMF5102TEE](#) [1210W2J047KT5E](#) [YLR12-2-4F-W](#) [HOT\(0.25x1.3\)-3.2-0R-I](#) [HOT\(0.4x1.5\)-5.2-0R-I](#)
[HoT\(0.45x1.5\)-8.2-0R-I](#) [0201WMF1103TEE](#) [0201WMF7152TEE](#) [1210W2J0124T5E](#) [201007J010LT4E](#) [201007J0360T4E](#) [201007J0430T4E](#)
[0805W8F931KT5E](#) [1206W4F5231T5E](#) [1210W2J0620T5E](#) [201007J0822T4E](#) [0201WMF1005TCE](#) [0201WMF1212TCE](#) [0201WMF1373TCE](#)
[0201WMF1400TCE](#) [0201WMF2000TEE](#) [0201WMF2001TCE](#) [0201WMF226JTCE](#) [0201WMF2672TCE](#) [0201WMF2803TCE](#)
[0201WMF357JTCE](#) [0201WMF3743TCE](#) [0201WMF430JTCE](#) [0201WMF4990TCE](#) [0201WMF5104TCE](#) [0201WMF510JTEE](#)
[0201WMF5110TCE](#) [0201WMF6652TEE](#) [0201WMF6812TCE](#) [0201WMF8200TCE](#)