

Interlock Switches

Tongue Switches

Elf



Description

The Elf is a tongue (or key) operated safety interlock switch designed to fit at the leading edge of sliding, hinged or liftoff guards. The Elf's unique miniature housing (only 75 × 25 × 29mm) makes it the smallest interlock currently available. It is designed for smaller machines such as printers, copiers or domestic machinery which, until now, have been unable to use safety interlocks due to space restrictions. With its dual entry slots and rotatable head, the versatile Elf can offer up to eight different actuator entry options.

Operation of the switch is achieved through the insertion of a specially profiled stainless steel key that is permanently mounted to the guard door. The semi-flexible key allows the Elf to be used on small radii doors (60mm or 2.36in).

The Elf is available with 2 N.C. or 1 N.O. and 1 N.C. safety contact and conduit entry (1 × M16 or connector style) sealed to IP67 (watertight and dustproof). A blanking plug is supplied for the unused key entry.

Features

- Ideal for small, light weight guards
- The smallest interlock switch available
- Contacts, 2 N.C. or 1 N.O. & 1 N.C.
- Eight possible actuator entry points, easy to install
- Environmental protection: IP67

Specifications

Standards	EN954-1, ISO13849-1, IEC/EN60204-1, NFPA79, EN1088, ISO14119, IEC/EN60947-5-1, ANSI B11.19, AS4024.1
Category	Cat. 1 Device per EN954-1 Dual channel interlocks suitable for Cat. 3 or 4 systems
Approvals	CE marked for all applicable directives, cULus and BG
Safety Contacts	1 N.C. or 2 N.C. direct opening action
Designation/Utilization Cat.	A600/AC-15 (Ue) (Ie) N600/DC-13 (Ue) (Ie)
	600V 500V 240V 120V 1.2A 1.4A 3A 6A 600V 500V 250V 125V 0.4A 0.55A 1.1A 2.2A
Thermal Current (Ith)	10A
Minimum Current	5V 5mA DC
Safety Contact Gap	>2mm (0.078in)
Rtd. Impulse withstand Volt.	(Uimp) 2500V
Auxiliary Contacts	1 N.O.
Pollution Degree ①	3
Actuator Travel for Positive Opening	3.6mm (0.141in)
Min Operating Radius	150mm (5.90in) 60mm (2.36in) with GD2 kit
Break Contact Min Force	6N (1.35lb)
Max Actuation Speed	160mm (6.29in) per sec
Max Actuation Frequency	2 Cycle per sec
Case Material	UL approved glass filled polyester
Actuator Material	Stainless Steel
Protection	IP67
Conduit Entry	1 × M16 or quick-disconnect style
Operating Temperature	-20°C to +80°C (-4°F to +176°F)
Fixing	2 × M4
Mounting	Any position
Mechanical Life	1,000,000 operations
Electrical Life	1,000,000 operations
Weight	60g (2.11oz)
Colour	Red

① Conductive pollution occurs, or dry, non conductive pollution occurs which becomes conductive due to condensation.

Applications







Note: Lift-off guards require good alignment when using tongue actuated interlock switches.
IMPORTANT: It must not be possible to lift the guard without actuating the interlock. An interlock on either side may be required.

Product Selection

Safety Contacts	Auxiliary Contacts	BBM/MBB	Actuator	Catalogue Number		
				M16 Conduit	M16 Conduit/ 1/2in Adaptor	Quick Disconnect
1 N.C.	1 N.O.	BBM	Flat	440K-E33036	440K-E33029	440K-E33074
			90°	440K-E33040	440K-E33030	440K-E33025
			GD2 Metal Align. Guide w/Semi-Flex Actuator	—	440K-E33031	440K-E33075
			—	440K-E33014	—	440K-E33076
2 N.C.	—	—	Flat	440K-E33080	440K-E33037	440K-E33077
			90°	440K-E33041	440K-E33045	440K-E33024
			GD2 Metal Align. Guide w/Semi-Flex Actuator	—	440K-E33046	440K-E33078
			—	440K-E33047	—	440K-E33079
		Recommended mating cable, 2m (6.5ft). See page 15-10 for details and additional lengths.				889D-F4AC-2

Accessories

Description	For Dimensions See Page	Catalogue Number	
	Flat Actuator	14-6	440K-A21014
	90° Actuator	14-6	440K-A21006
	GD2 Metal Alignment Guide with Semi-Flexible Actuator	14-6	440K-A21030
	Alignment Guide	14-6	440K-A21069
	Mounting Plate	14-6	440K-A33624

Interlock Switches

Tongue Switches

Elf

Approximate Dimensions—mm (inches)

Dimensions are not intended to be used for installation purposes.

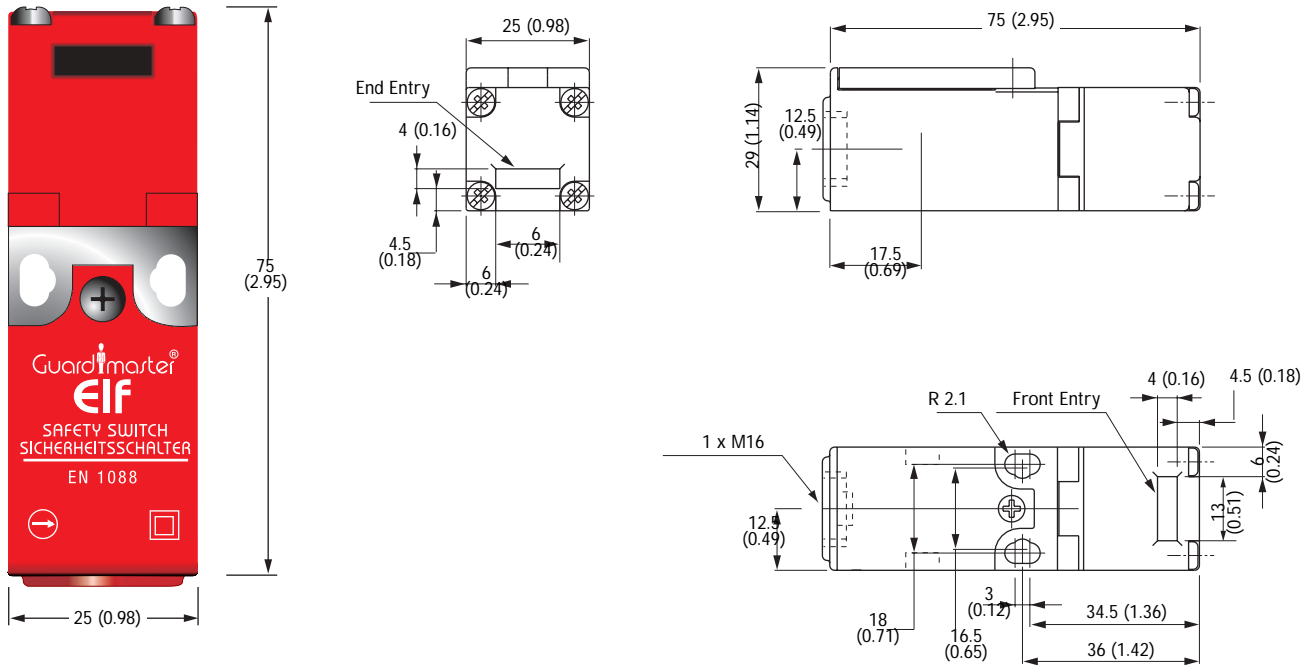

Typical Wiring Diagrams (shown with guard closed, actuator inserted)

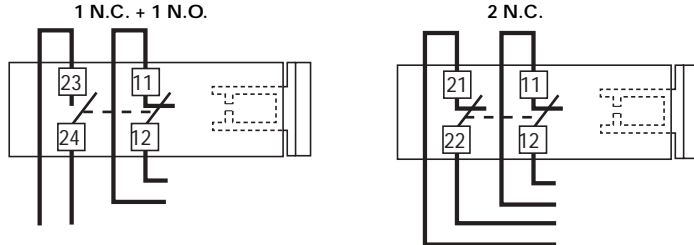

Connector Pinout		1 N.C. + 1 N.O.		2 N.C.	
		Terminal	Contact	Terminal	Contact
	1	11	N.C.	11	N.C.
	3	12	N.C.	12	N.C.
	2	23	N.O.	21	N.C.
	4	24	N.O.	22	N.C.

Contact Action

□ Contact Open ■ Contact Closed

Actuator withdrawal distance from full insertion

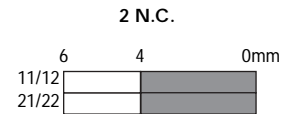
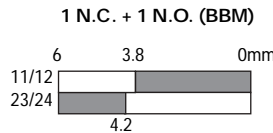

Application Details

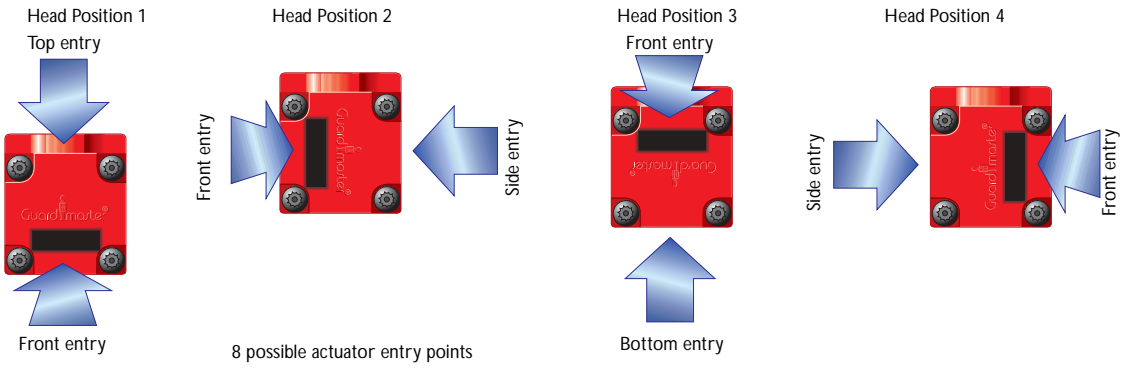
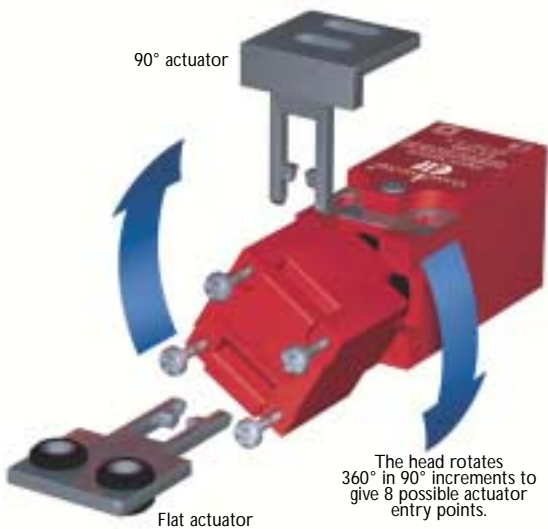

GD2 Metal Alignment Guide with semi-flexible actuator



X-ON Electronics

Largest Supplier of Electrical and Electronic Components

Click to view similar products for [Emergency Stop Switches / E-Stop Switches](#) category:

Click to view products by [Guard Master](#) manufacturer:

Other Similar products are found below :

[84-5021.2B40](#) [84-6830.0020](#) [A01ESSP8](#) [A22EL-M-24A-11B](#) [AVN302N-R](#) [A165E-S-01\(STOP\)](#) [AYLD2212602SN-R-TK962](#)
[AVLD39911N-R-24V](#) [A22Z-EG22](#) [A165E-SY](#) [3100.0110Y](#) [3050.1302Y](#) [3SE2243-0XX40](#) [3SK1111-2AB30](#) [3SK1211-1BB40](#) [44-710](#) [84-](#)
[6841.2B20](#) [84-6830.0040](#) [H3141AAKAA](#) [A165E-R-24D-01](#) [E3102AAAAB](#) [A22E-M-03](#) [ZA2BV05](#) [A22EL-M-T2-01](#) [951FY000-WO](#)
[ER6022-022N](#) [952+2000-00](#) [ES3S51653](#) [601+0000-OP](#) [E3101AAAAB](#) [84-5130.0040](#) [CS AR-05V024](#) [CS AR-22V024](#) [DS AE1VA](#) [DS](#)
[KB2A](#) [DS KB3A](#) [HE2G-21SHE-L-K](#) [HE6B-M211Y](#) [774191](#) [774316](#) [777760](#) [R1.100.0129.0 SMA0129- NO/NO](#) [R1.188.0640.0 SNV](#)
[4063KL-A](#) [R1.188.1810.0 SNA 4043K-A](#) [R1.188.1840.0 SNA 4043K-A](#) [SR BD40ALK-B02F](#) [AVLW39911D-R-120V](#) [AYD311NUG](#)
[AVLD32211DNUR](#) [84-5040.0020.0049](#)