

Pos	A	B	C	Pos	A	B	C
4	9.70	3.81	5.60	16	24.94	19.05	20.84
6	12.24	6.35	8.14	18	27.48	21.59	23.38
8	14.78	8.89	10.68	20	30.02	24.13	25.92
10	17.32	11.43	13.22	22	32.56	26.67	28.46
12	19.86	13.97	15.76	24	35.10	29.21	31.00
14	22.40	16.51	18.30	26	37.64	31.75	33.54

Specifications

Current Rating:1.0A AC/DC
 Voltage Rating:30V AC/DC
 Contact Resistance:20m Ohm. Max.
 Insulation Resistance:1,000M Ohm. Min.
 Withstanding Voltage:500V AC For One Minute
 Operating Temperature Range:-40°C ~ +105°C
 Material And Finish
 Insulator:High Temp. Plastic(Nylon46 UL94V-0)
 Insulator Color:Red
 Contact:Phosphor Bronze
 Plated:Tin Plated
 Package:800Pcs/Reel



How to Order

TMM-X-X-XX-X

Type
 1-IDC Male
 2-IDC Plug
 3-DIP Male Straight
 4-DIP Female Straight
 5-DIP Female R/A
 6-SMT Female Straight

Locking System
 0-without lock
 L-with lock

Packaging
 1 - Tape & Reel
 2 - Tube
 3 - Bag

Number of Positions
 04, 06, 08, 10, 12,
 14, 16, 18 or 20

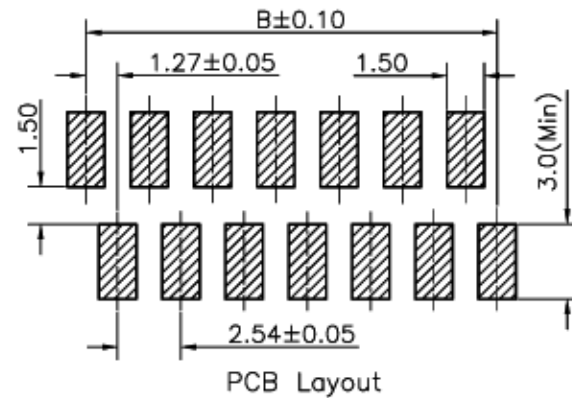

TOLERANCE (mm)	APPROVALS	DATE	TITLE	AMPHENOL Amphenol European Design Center	
X, ±0.3	DRAWN Stephane	2008/04/22	Micro Match Female SMT w/ Lock	Scale N.A.	Sheet 1 of 2
X.X, ±0.1	CHECKED Rob K.	2008/04/23			
X.XX, ±0.05	APPROVED Rob K.	2008/04/23			
UNLESS OTHERWISE SPECIFIED	UNIT MM	SIZE A4	DRAWING N° TMM-6-L-XX-1	REV A	

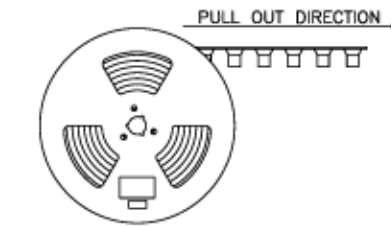
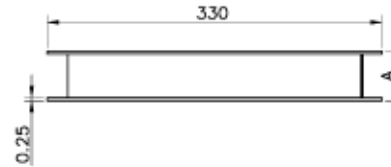
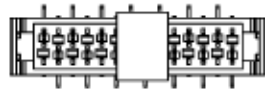

Note:

- 1.All dimensions meet EIA-481-3 requirements.
- 2.Material : Black Conductive Polystyrene Alloy
100% recyclable.
- 3.Thickness : 0.40±0.05mm
- 4.Component load per 13" reel :800 pcs.
- 5.CARTON SIZE:350*350*296(MM)

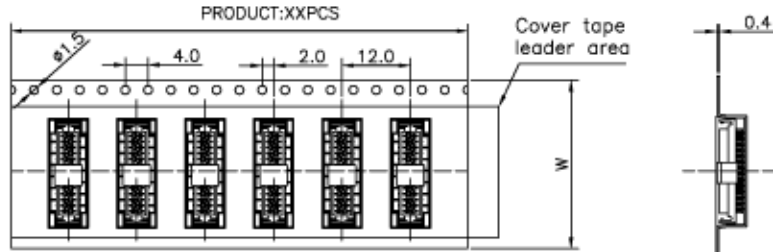

For Reel width (dimension W)16,24mm ,Single row hole

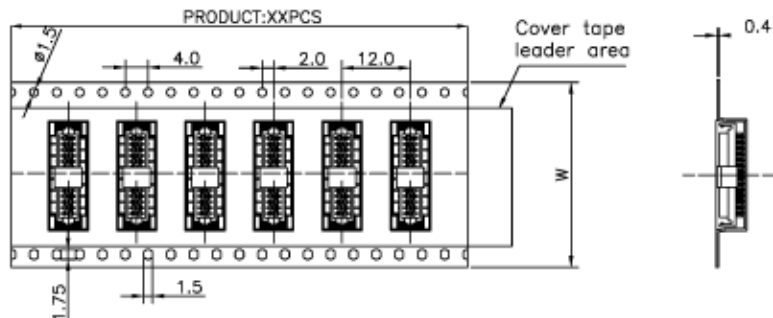

For Reel width (dimension W)32,44,56,72mm ,Double rows hole

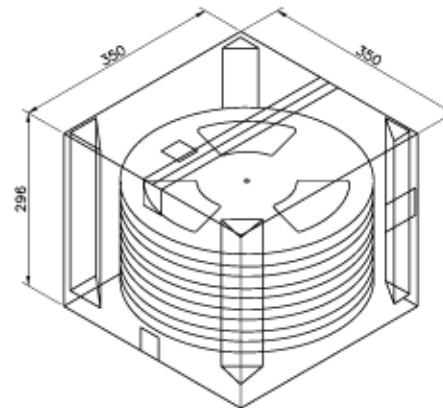

Pin No	W	A	PCS/R	R/CTN	Q'TY
4	16	21	800	12	9600
6	24	29	800	9	7200
8	32	37	800	7	5600
10	32	37	800	7	5600
12	32	37	800	7	5600
14	44	49	800	5	4000
16	44	49	800	5	4000
18	44	49	800	5	4000
20	44	49	800	5	4000
22	44	49	800	5	4000
24	56	61	800	4	3200
26	56	61	800	4	3200

TOLERANCE (mm)	APPROVALS	DATE	TITLE	AMPHENOL Amphenol European Design Center	
X. ±0.3	DRAWN Stephane	2008/04/22	Micro Match Female SMT w/ Lock	Scale N.A.	Sheet 2 of 2
X.X ±0.1	CHECKED Rob K.	2008/04/23			
X.XX ±0.05	APPROVED Rob K.	2008/04/23			
UNLESS OTHERWISE SPECIFIED	UNIT	MM	SIZE A4	DRAWING N° TMM-6-L-XX-1	REV. A

X-ON Electronics

Largest Supplier of Electrical and Electronic Components

Click to view similar products for [Headers & Wire Housings](#) category:

Click to view products by [Amphenol](#) manufacturer:

Other Similar products are found below :

[95000-104TRLF](#) [10135584-644402LF](#) [DF62W-EP2022PCA](#) [95000-106TRLF](#) [DF62W-2022SCA](#) [48050-002LF](#) [DF62W-EP2022PC](#) [2203348](#)
[DF62W-2022SC](#) [1084018](#) [1029039](#) [1084017](#) [802-10-012-10-002000](#) [1112640](#) [1112639](#) [000-34000](#) [0008550134](#) [0009482033](#) [0009507031](#)
[0009524054](#) [57102-F02-18ULF](#) [57102-S06-03LF](#) [57202-S52-04LF](#) [PCN6-15S-2.5E](#) [0039019024](#) [58102-G61-06LF](#) [582553-1](#) [0009485154](#)
[0009508121](#) [0022285053](#) [0050291907](#) [018731A](#) [LY20-4P-DT1-P1E-BR](#) [02.125.8002.8](#) [60101931](#) [60598-1 \(Cut Strip\)](#) [M1625-3R/100](#) [61062-3](#)
[61082-181009](#) [636-1427](#) [638009-1](#) [641938-9](#) [641991-4](#) [644168-1](#) [644827-2](#) [647662-1](#) [65039-019ELF](#) [65692-001LF](#) [65781-018](#) [65781-047](#)