

Features

1 & 2 Pole relay range

- 46.52 - 2 Pole 8 A
- 46.61 - 1 Pole 16 A

- Socket mount or direct connection via Faston connectors
- AC coils & DC coils
- Available with: lockable test button, mechanical indicator & LED indicator
- 8 mm, 6 kV (1.2/50 µs) isolation, coil-contacts
- Cadmium Free contacts
- European Patent

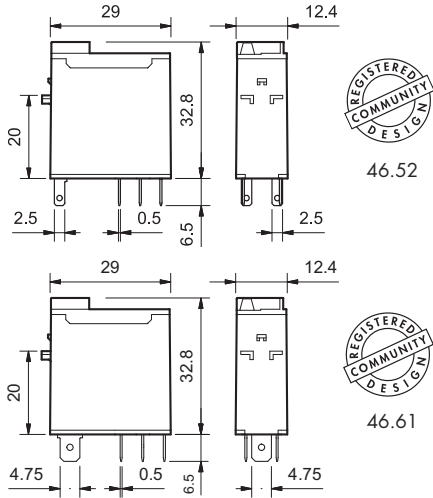

FOR UL RATINGS SEE:
"General technical information" page V

46.52



- 2 Pole CO, 8 A
- Plug-in/Solder terminals

46.61



- 1 Pole CO, 16 A
- Plug-in/Faston 187

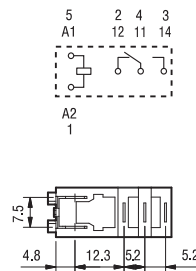
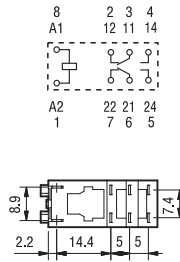

Contact specification

Contact configuration	2 CO (DPDT)	1 CO (SPDT)
Rated current/Maximum peak current A	8/15	16/25 *
Rated voltage/Maximum switching voltage V AC	250/440	250/440
Rated load AC1 VA	2,000	4,000
Rated load AC15 (230 V AC) VA	350	750
Single phase motor rating (230 V AC) kW	0.37	0.55
Breaking capacity DC1: 30/110/220 V A	6/0.5/0.15	12/0.5/0.15
Minimum switching load mW (V/mA)	300 (5/5)	300 (5/5)
Standard contact material	AgNi	AgNi

* With the AgSnO₂ material the maximum peak current is 80 A - 5 ms on normally open contact.

Coil specification

Nominal voltage (U _N) V AC (50/60 Hz)	12 - 24 - 48 - 110 - 120 - 230 - 240
V DC	12 - 24 - 48 - 110 - 125
Rated power VA/W	1.2/0.5
Operating range AC	(0.8...1.1)U _N
DC	(0.73...1.1)U _N
Holding voltage AC/DC	0.8U _N / 0.4U _N
Must drop-out voltage AC/DC	0.2U _N / 0.1U _N

Technical data

Mechanical life AC/DC cycles	10 · 10 ⁶
Electrical life at rated load AC1 cycles	100 · 10 ³
Operate/release time ms	10/3
Insulation between coil and contacts (1.2/50 µs)kV	6 (8 mm)
Dielectric strength between open contacts V AC	1,000
Ambient temperature range °C	-40 ... +70
Environmental protection	RT II

Approvals (according to type)



Ordering information

Example: 46 series Miniature industrial relay, 1 CO (SPDT), 24 V DC coil, lockable test button and mechanical indicator.

	4	6	6	1	9	0	2	4	0	0	4	0
									A	B	C	D
Series												
Type												
5 = Spade/blade solder terminal (2.5x0.5)mm												
6 = Spade/blade terminal Faston 187 (4.8x0.5)mm												
No. of poles												
1 = 1 pole, 16 A												
2 = 2 poles, 8 A												
Coil version												
9 = DC												
8 = AC (50/60 Hz)												
Coil voltage												
See coil specifications												
									A: Contact material		D: Special versions	
									0 = AgNi		0 = Standard	
									4 = AgSnO ₂ (46.61 only)		C: Options	
									5 = AgNi + Au (5 µm)		2 = Mechanical indicator	
									B: Contact circuit		4 = Lockable test button + mechanical indicator	
									0 = CO (nPDT)		54 = Lockable test button + LED (AC) + mechanical indicator	
											74 = Lockable test button + double LED (DC non-polarized) + mechanical indicator	

Selecting features and options: only combinations in the same row are possible.
Preferred selections for best availability are shown in **bold**.

Type	Coil version	A	B	C	D
46.52	AC - DC	0 - 5	0	2 - 4	0
	AC	0 - 5	0	54	/
	DC	0 - 5	0	74	/
46.61	AC - DC	0 - 4 - 5	0	2 - 4	0
	AC	0 - 4 - 5	0	54	/
	DC	0 - 4 - 5	0	74	/

Special versions for Rail Applications on request

Descriptions: Options

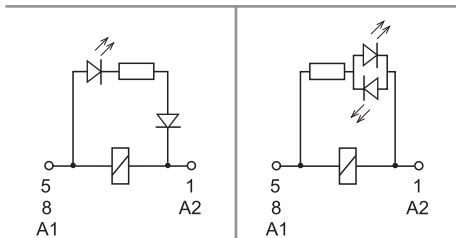

C: Option 54
LED (AC)

C: Option 74
LED (DC, non-polarized)

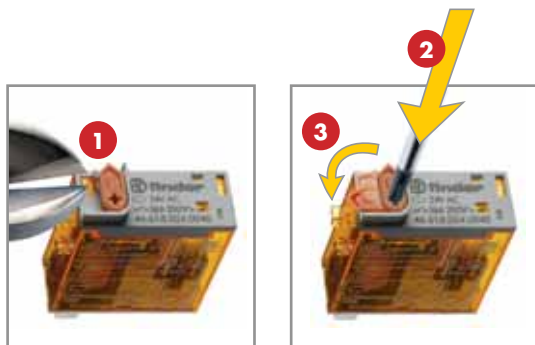

Lockable test button and mechanical flag indicator (0040, 0054, 0074)

The dual-purpose Finder test button can be used in two ways:

Case 1) The plastic pip (located directly below the test button) remains intact. In this case, when the test button is pushed, the contacts operate. When the test button is released the contacts return to their former state.

Case 2) The plastic pip is broken-off (using an appropriate cutting tool). In this case, (in addition to the above function), when the test button is pushed and rotated, the contacts are latched in the operating state, and remain so until the test button is rotated back to its former position. In both cases ensure that the test button actuation is swift and decisive.



Technical data

Insulation according to EN 61810-1		1 pole		2 pole	
Nominal voltage of supply system	V AC	230/400		230/400	
Rated insulation voltage	V AC	250	400	250	400
Pollution degree		3	2	3	2
Insulation between coil and contact set					
Type of insulation		Reinforced (8 mm)		Reinforced (8 mm)	
Overvoltage category		III		III	
Rated impulse voltage	kV (1.2/50 μ s)	6		6	
Dielectric strength	V AC	4,000		4,000	
Insulation between adjacent contacts					
Type of insulation		—		Basic	
Overvoltage category		—		III	
Rated impulse voltage	kV (1.2/50 μ s)	—		4	
Dielectric strength	V AC	—		2,000	
Insulation between open contacts					
Type of disconnection		Micro-disconnection		Micro-disconnection	
Dielectric strength	V AC/kV (1.2/50 μ s)	1,000/1.5		1,000/1.5	
Conducted disturbance immunity					
Burst (5...50)ns, 5 kHz, on A1 - A2		EN 61000-4-4		level 4 (4 kV)	
Surge (1.2/50 μ s) on A1 - A2 (differential mode)		EN 61000-4-5		level 3 (2 kV)	
Other data		46.61		46.52	
Bounce time: NO/NC	ms	2/6		1/4	
Vibration resistance (10...150)Hz: NO/NC	g	20/12		20/15	
Shock resistance	g	20		20	
Power lost to the environment	without contact current	W	0.6		0.6
	with rated current	W	1.6		2
Recommended distance between relays mounted on PCB	mm	≥ 5			

Contact specification

F 46 - Electrical life (AC) v contact current
Type 46.52

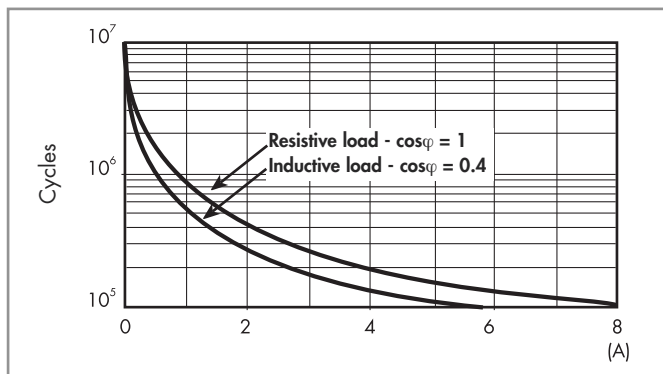

F 46 - Electrical life (AC) v contact current
Type 46.61

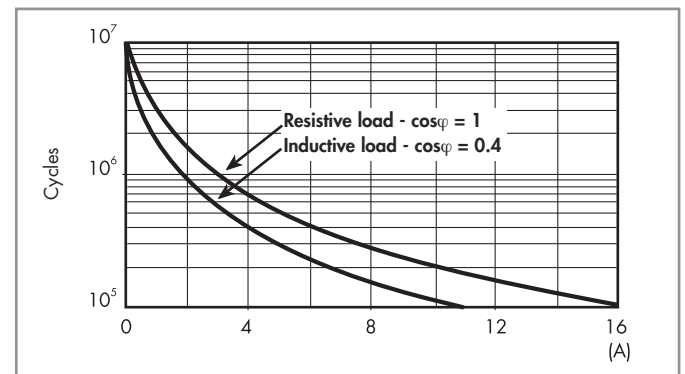

H 46 - Maximum DC1 breaking capacity

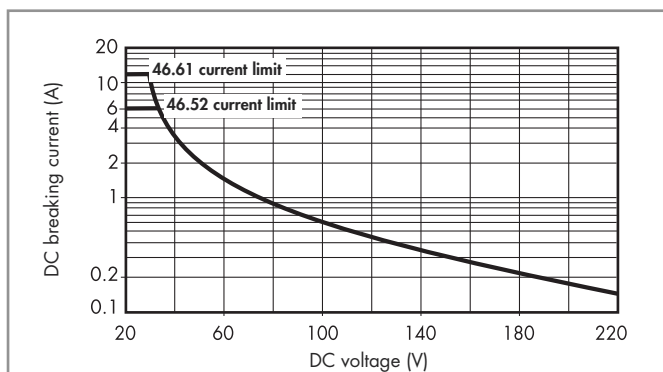

- When switching a resistive load (DC1) having voltage and current values under the curve, an electrical life of $\geq 100 \cdot 10^3$ can be expected.
- In the case of DC13 loads, the connection of a diode in parallel with the load will permit a similar electrical life as for a DC1 load.
Note: the release time for the load will be increased.

Coil specifications

DC coil data

Nominal voltage U_N V	Coil code	Operating range		Resistance R Ω	Rated coil consumption I at U_N mA
		U_{min} V	U_{max} V		
12	9.012	8.8	13.2	300	40
24	9.024	17.5	26.4	1,200	20
48	9.048	35	52.8	4,800	10
110	9.110	80	121	23,500	4.7
125	9.125	91.2	138	32,000	3.9

AC coil data

Nominal voltage U_N V	Coil code	Operating range		Resistance R Ω	Rated coil consumption I at U_N mA
		U_{min} V	U_{max} V		
12	8.012	9.6	13.2	80	90
24	8.024	19.2	26.4	320	45
48	8.048	38.4	52.8	1,350	21
110	8.110	88	121	6,900	9.4
120	8.120	96	132	9,000	8.4
230	8.230	184	253	28,000	5
240	8.240	192	264	31,500	4.1

R 46 - DC coil operating range v ambient temperature

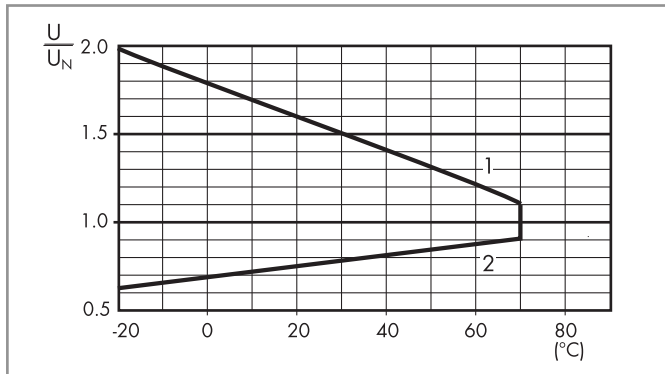

- 1 - Max. permitted coil voltage.
2 - Min. pick-up voltage with coil at ambient temperature.

R 46 - AC coil operating range v ambient temperature

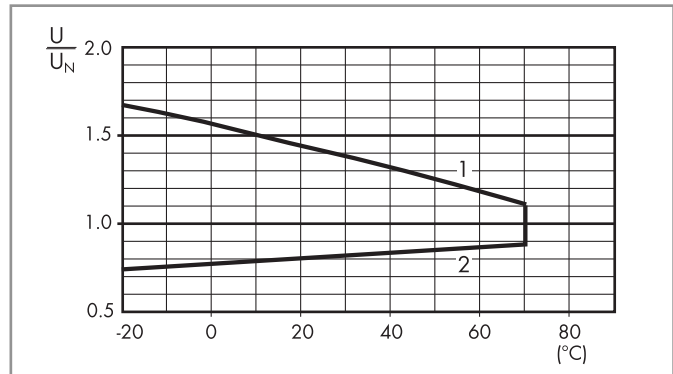

- 1 - Max. permitted coil voltage.
2 - Min. pick-up voltage with coil at ambient temperature.

Accessories



046.05



046.05 with relay

Flange mount adaptor for relays types 46.52 and 46.61

046.05

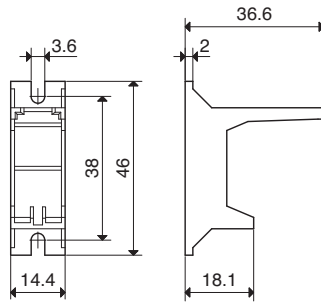

046.05

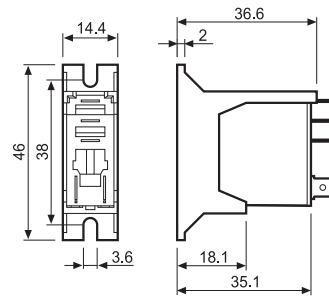

046.05 with relay



046.07



046.07 with relay

35 mm rail adaptor for relays types 46.52 and 46.61

046.07

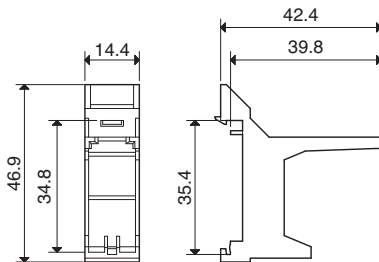

046.07

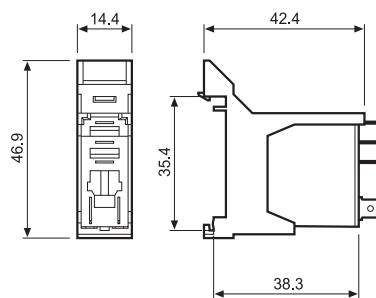

046.07 with relay

Sheet of marker tags for relays types 46.52 and 46.61 (72 tags), 6x12mm

060.72



060.72

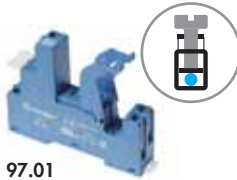

97.01

Approvals
(according to type):



97.01

Screw terminal socket panel or 35 mm rail (EN 60715) mount	97.01 (blue)	97.01.0 (black)	97.02 (blue)	97.02.0 (black)
For relay type	46.61		46.52	
Accessories				
Plastic retain and release clip (supplied with socket - packaging code SPA)			097.01	
Metal retaining clip			097.71	
Identification tag			095.00.4	
8-way jumper link	095.18 (blue)		095.18.0 (black)	
Modules (see table below)			99.02	
Timer modules (see table below)			86.30	
Technical data				
Rated current	16 A - 250 V AC		8 A - 250 V AC	
Dielectric strength	6 kV (1.2/50 μs) between coil and contacts			
Protection category	IP 20			
Ambient temperature	°C -40...+70 (see diagram L97)			
⊕ Screw torque	Nm 0.8			
Wire strip length	mm 8			
Max. wire size for 97.01 and 97.02 sockets		solid wire	stranded wire	
	mm ²	1x6 / 2x2.5	1x4 / 2x2.5	
	AWG	1x10 / 2x14	1x12 / 2x14	

L 97 - Rated current vs ambient temperature (for 46.61 relay / 97.01 socket combination)

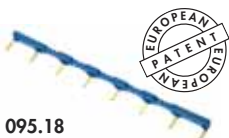
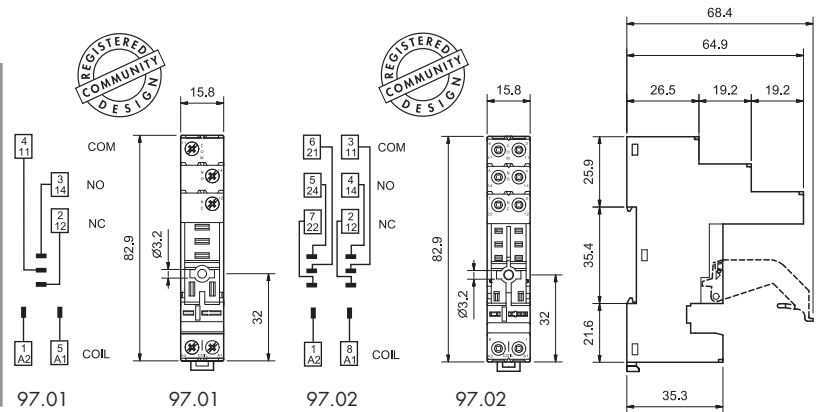
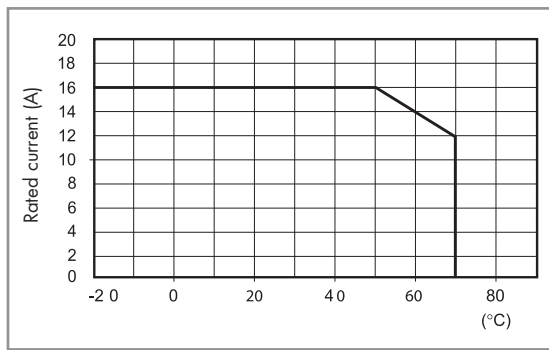

095.18



8-way jumper link for 97.01 and 97.02 sockets	095.18 (blue)	095.18.0 (black)
Rated values	10 A - 250 V	

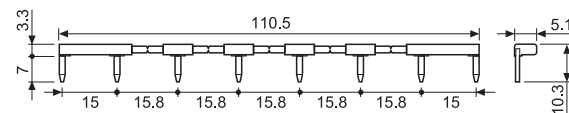

86.30

86 series timer module	
(12...24)V AC/DC; Bi-function: AI, DI; (0.05s...100h)	86.30.0.024.0000
(110...125)V AC; Bi-function: AI, DI; (0.05s...100h)	86.30.8.120.0000
(230...240)V AC; Bi-function: AI, DI; (0.05s...100h)	86.30.8.240.0000

Approvals
(according to type):



99.02

99.02 coil indication and EMC suppression modules for 97.01 and 97.02 sockets		
Diode (+A1, standard polarity)	(6...220)V DC	99.02.3.000.00
LED	(6...24)V DC/AC	99.02.0.024.59
LED	(28...60)V DC/AC	99.02.0.060.59
LED	(110...240)V DC/AC	99.02.0.230.59
LED + Diode (+A1, standard polarity)	(6...24)V DC	99.02.9.024.99
LED + Diode (+A1, standard polarity)	(28...60)V DC	99.02.9.060.99
LED + Diode (+A1, standard polarity)	(110...220)V DC	99.02.9.220.99
LED + Varistor	(6...24)V DC/AC	99.02.0.024.98
LED + Varistor	(28...60)V DC/AC	99.02.0.060.98
LED + Varistor	(110...240)V DC/AC	99.02.0.230.98
RC circuit	(6...24)V DC/AC	99.02.0.024.09
RC circuit	(28...60)V DC/AC	99.02.0.060.09
RC circuit	(110...240)V DC/AC	99.02.0.230.09
Residual current by-pass	(110...240)V AC	99.02.8.230.07

Approvals
(according to type):



DC Modules with non-standard polarity (+A2) on request.

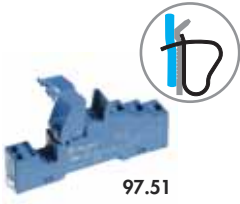

97.51

Approvals (according to type):



097.01

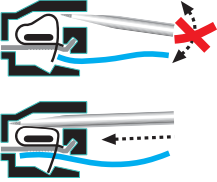
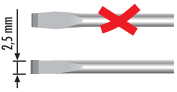

Screwless terminal socket panel or 35 mm rail (EN 60715) mount	97.51 (blue)	97.51.0 (black)	97.52 (blue)	97.52.0 (black)
For relay type	46.61		46.52	
Accessories				
Plastic retain and release clip (supplied with socket - packaging code SPA)			097.01	
Metal retaining clip			097.71	
Modules (see table below)			99.02	
Timer modules (see table below)			86.30	
Technical data				
Rated current	10 A - 250 V AC		8 A - 250 V AC	
Dielectric strength	6 kV (1.2/50 μs) between coil and contacts			
Protection category	IP 20			
Ambient temperature	°C -25...+70			
Wire strip length	mm 8			
Max. wire size for 97.51 and 97.52 sockets	solid wire		stranded wire	
	mm ²	2x(0.2...1.5)		2x(0.2...1.5)
	AWG	2x(24...18)		2x(24...18)

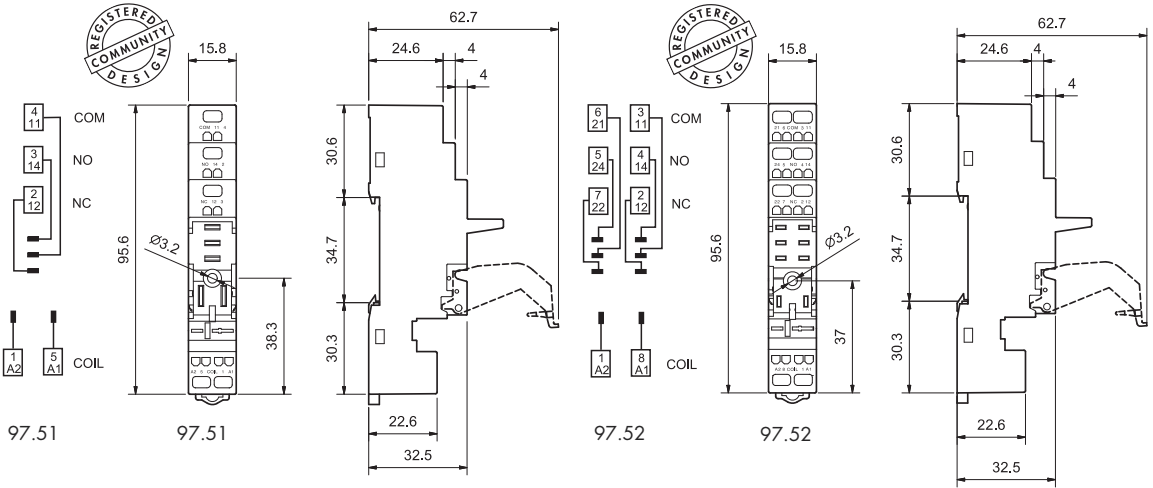

86.30

86 series timer module	
(12...24)V AC/DC; Bi-function: AI, DI; (0.05s...100h)	86.30.0.024.0000
(110...125)V AC; Bi-function: AI, DI; (0.05s...100h)	86.30.8.120.0000
(230...240)V AC; Bi-function: AI, DI; (0.05s...100h)	86.30.8.240.0000

Approvals (according to type):



99.02

Approvals (according to type):



DC Modules with non-standard polarity (+A2) on request.

99.02 coil indication and EMC suppression modules for 97.51 and 97.52 sockets		
Diode (+A1, standard polarity)	(6...220)V DC	99.02.3.000.00
LED	(6...24)V DC/AC	99.02.0.024.59
LED	(28...60)V DC/AC	99.02.0.060.59
LED	(110...240)V DC/AC	99.02.0.230.59
LED + Diode (+A1, standard polarity)	(6...24)V DC	99.02.9.024.99
LED + Diode (+A1, standard polarity)	(28...60)V DC	99.02.9.060.99
LED + Diode (+A1, standard polarity)	(110...220)V DC	99.02.9.220.99
LED + Varistor	(6...24)V DC/AC	99.02.0.024.98
LED + Varistor	(28...60)V DC/AC	99.02.0.060.98
LED + Varistor	(110...240)V DC/AC	99.02.0.230.98
RC circuit	(6...24)V DC/AC	99.02.0.024.09
RC circuit	(28...60)V DC/AC	99.02.0.060.09
RC circuit	(110...240)V DC/AC	99.02.0.230.09
Residual current by-pass	(110...240)V AC	99.02.8.230.07



97.11

Approvals
(according to type):



97.12

Approvals
(according to type):



PCB socket	97.11 (blue)	97.12 (blue)
For relay type	46.61	46.52
Technical data		
Rated values	12 A - 250 V (see diagram L97)	8 A - 250 V
Dielectric strength	6 kV (1.2/50 μs) between coil and contacts	
Protection category	IP 20	
Ambient temperature	°C -40...+70	

L 97 - Rated current vs ambient temperature
(for 46.61 relay / 97.11 socket combination)

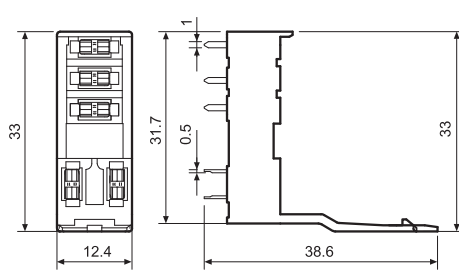
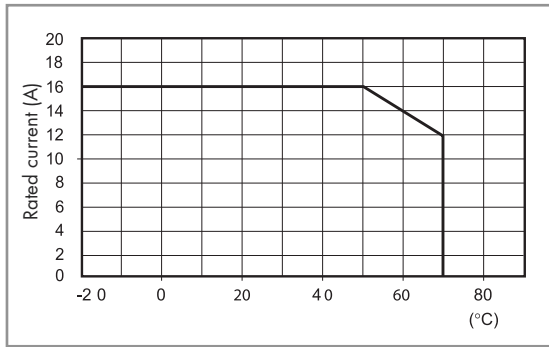

97.11

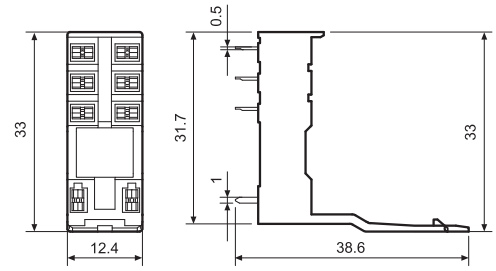

97.12

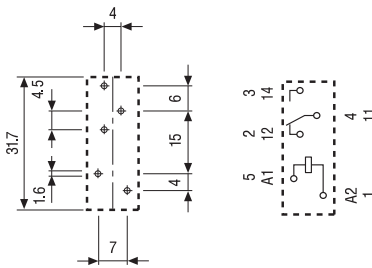

Copper side view

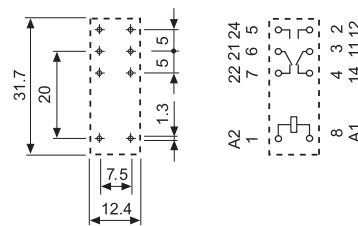

Copper side view

Packaging codes

How to code and identify retaining clip and packaging options for sockets.

Example:

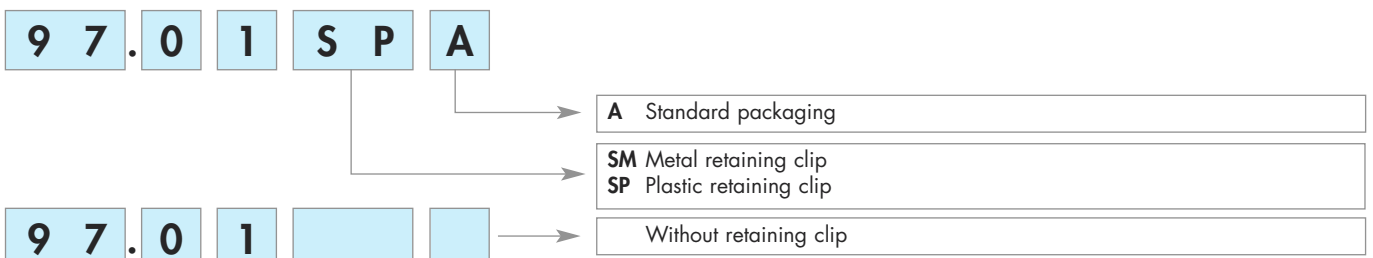

X-ON Electronics

Largest Supplier of Electrical and Electronic Components

Click to view similar products for [Industrial Relays](#) category:

Click to view products by [Finder](#) manufacturer:

Other Similar products are found below :

[6-1618400-7](#) [686-117111](#) [686-120111](#) [EV250-4A-02](#) [EV250-6A-01](#) [FCA-125-CX8](#) [FCA-410-138](#) [8-1618393-1](#) [GCA32A208VAC60HZ](#)
[GCA32A220VAC50/60HZ](#) [GCA32A230VAC50/60HZ](#) [GCA32A240VAC50/60HZ](#) [GCA32A48VAC60HZ](#) [GCA63A120VAC50/60HZ](#)
[GCA63A208VAC60HZ](#) [GCA63A220VAC60HZ](#) [GCA63A230VAC50/60HZ](#) [GCA63A240VAC50/60HZ](#) [GCA63A277VAC60HZ](#)
[GCA63A48VAC60HZ](#) [GCA63A500VAC50/60HZ](#) [GCA63A600VAC60HZ](#) [GCA800A200VACDC](#) [GCA95A110VAC50/60HZ](#)
[GCA95A120VAC50/60HZ](#) [GCA95A12VDC](#) [GCA95A240VAC50/60HZ](#) [GCA95A24VAC50/60HZ](#) [GCA95A48VAC60HZ](#) [ACC530U20](#)
[ACC730U30](#) [1395832-1](#) [RM699BV-3011-85-1005](#) [RMIA210230AC](#) [RMIA45024AC](#) [1423675-8](#) [B07B032AC1-0329](#) [B329](#) [1617807-1](#)
[N417](#) [P25-E5019-1](#) [P30C42A12D1-120](#) [2-1618398-1](#) [PBO-18A1218](#) [2307497](#) [RPYA00324LT](#) [RPYA003A120LT](#) [KR-4539-1](#)
[RT334012WG](#) [S160156115](#)