

Touchpad click

2. Soldering the headers

Before using your click board™, make sure to solder 1x8 male headers to both left and right side of the board. Two 1x8 male headers are included with the board in the package.

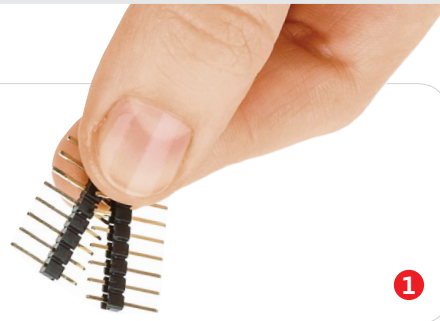

2

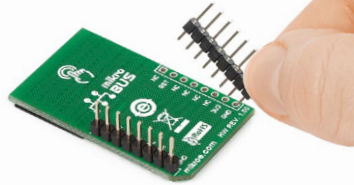

Turn the board upside down so that the bottom side is facing you upwards. Place shorter pins of the header into the appropriate soldering pads.

3

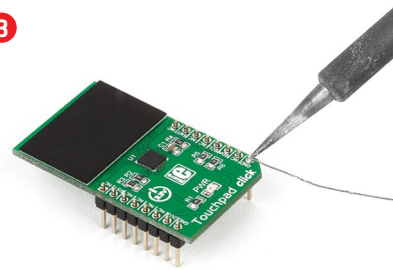

Turn the board upward again. Make sure to align the headers so that they are perpendicular to the board, then solder the pins carefully.

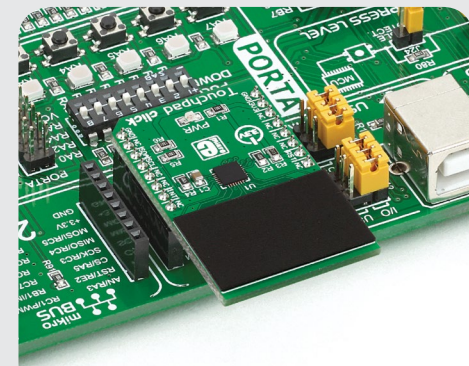

4. Essential features

The MTCH6102 device supports taps, doubletaps, swipes and scrolling gestures. The small capacitive surface is optimized for single-finger applications. The sensor outputs 12-bit resolution coordinate data [the I2C interface supports up to 400 kbps transfer rates]. MTCH6102 also incorporates power-saving features, such as a configurable frame rate for sleep/idle modes, as well as a separate standby and active mode.

1. Introduction

Touchpad click is a capacitive touch input device driven by Microchip's low-powered **MTCH6102 controller**. The touchpad surface is covered with a sheet of black plastic to demonstrate the chip's support for cover layers [up to 3mm for plastic, 5mm for glass] Touchpad click communicates with the target MCU through the mikroBUS™ I2C interface [SCL and SDA pins], with additional functionality provided by the Interrupt and RSTL pins. Designed to use a 3.3V power supply.

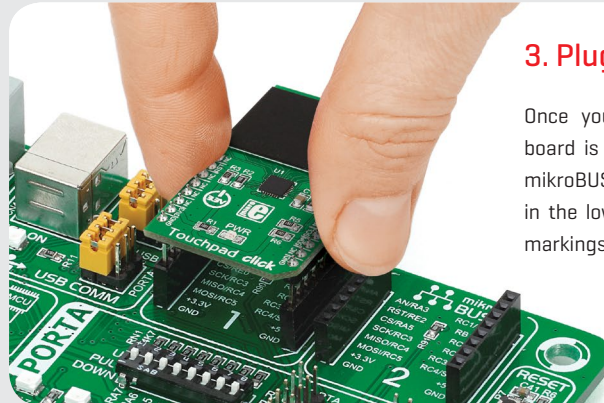

3. Plugging the board in

Once you have soldered the headers your board is ready to be placed into the desired mikroBUS™ socket. Make sure to align the cut in the lower-right part of the board with the markings on the silkscreen at the mikroBUS™ socket. If all the pins are aligned correctly, push the board all the way into the socket.

click
BOARDS™
www.mikroe.com

Touchpad click Manual v100



010000091166

5. Schematic

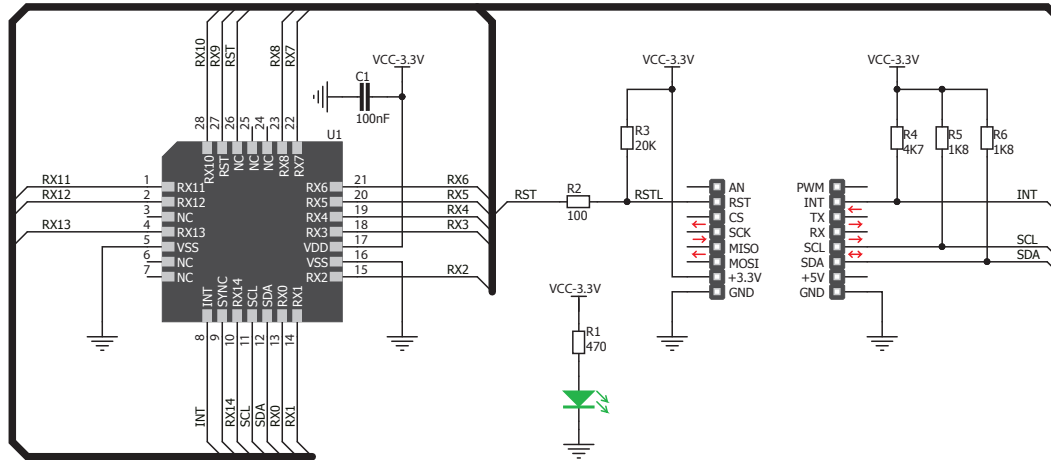

6. Dimensions

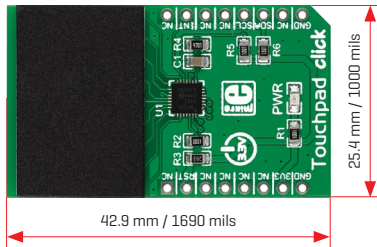

	mm	mils
LENGTH	42.9	1690
WIDTH	25.4	1000
HEIGHT*	3.9	154

* without headers

7. HMI click boards™

Touchpad click is just one of several input devices on click boards. For the entire selection, visit:

www.mikroe.com/click

8. Code examples

Once you have done all the necessary preparations, it's time to get your click board™ up and running. We have provided examples for mikroC™, mikroBasic™ and mikroPascal™ compilers on our **Libstock** website. Just download them and you are ready to start.



9. Support

MikroElektronika offers **free tech support** [www.mikroe.com/support] until the end of the product's lifetime, so if something goes wrong, we're ready and willing to help!



10. Disclaimer

MikroElektronika assumes no responsibility or liability for any errors or inaccuracies that may appear in the present document. Specification and information contained in the present schematic are subject to change at any time without notice.

Copyright © 2015 MikroElektronika.
All rights reserved.

X-ON Electronics

Largest Supplier of Electrical and Electronic Components

Click to view similar products for [Development Boards & Kits - Wireless](#) category:

Click to view products by [MikroElektronika](#) manufacturer:

Other Similar products are found below :

[13237ADC-SFTW](#) [13237ADC-BDM](#) [SLWRB4542B](#) [SLWRB4546A](#) [CC-WMX51-LX](#) [TWR-13237](#) [TWR-13237-KIT](#) [DA14585-00VVDB-P](#)
[MKR MOTOR CARRIER](#) [AC164159](#) [RD-88MW322-R0](#) [RD-88MW320-R0](#) [FMC PCAM ADAPTER](#) [BLE 4 CLICK](#) [C METER CLICK](#)
[HALL CURRENT CLICK](#) [COLOR 3 CLICK](#) [COMPASS 2 CLICK](#) [COMPASS CLICK](#) [HDC1000 CLICK](#) [RELAY CLICK](#) [RIVERDI](#)
[CLICK](#) [CUGSM113#UFL](#) [R METER CLICK](#) [MATRIX G CLICK](#) [MATRIX RGB CLICK](#) [3D MOTION CLICK](#) [3G SARA CLICK](#)
[TDGL012](#) [4-20MA R CLICK](#) [4-20MA T CLICK](#) [THERMO CLICK](#) [MCP2003B CLICK](#) [EXPAND 3 CLICK](#) [MCP2542 CLICK](#) [MCP25625](#)
[CLICK](#) [ATA663211 CLICK](#) [ATA8520-EK3-E](#) [TOUCHKEY CLICK](#) [MICROSD CLICK](#) [TRF CLICK](#) [BUTTON R CLICK](#) [IR ECLIPSE](#)
[CLICK](#) [IRTHERMO 2 CLICK](#) [UNIQUE ID CLICK](#) [UV 2 CLICK](#) [CAN-SPI CLICK 3.3V](#) [CAN-SPI CLICK 5V](#) [CAP EXTEND CLICK](#)
[CAPSENSE CLICK](#)