

# Resin-Coated, Radial-Lead Solid Tantalum Capacitors



## FEATURES

- Terminations: Standard SnPb, 100 % tin available
- Large capacitance range
- Encapsulated in a hard orange epoxy resin
- Large variety of lead styles available
- Supplied on tape and reel or ammpack
- Low impedance and ESR at high frequencies
- Material categorization: For definitions of compliance please see [www.vishay.com/doc?99912](http://www.vishay.com/doc?99912)



**RoHS\***  
COMPLIANT

## Note

\* Lead (Pb)-containing terminations are not RoHS-compliant. Exemptions may apply.

## ELECTRICAL CHARACTERISTICS

**Operating Temperature:** - 55 °C to + 85 °C: Type 489D  
- 55 °C to + 125 °C (above 85 °C, voltage derating is required): Type 499D

## APPLICATIONS

Offer a very cost effective solution in the consumer, industrial and professional electronics markets. The capacitors are intended for high volume applications.

ORDERING INFORMATION							
489D	686	X0	6R3	D	2	A	E3
TYPE	CAPACITANCE	CAPACITANCE TOLERANCE	DC VOLTAGE RATING AT + 85 °C	CASE CODE	LEAD STYLE	PACKAGING	RoHS COMPLIANT
489D Standard + 85 °C 499D Standard + 125 °C Low IL	Expressed in picofarads. The first two digits are the significant figures. The third is the number of zeros following.	X0 = ± 20 % X9 = ± 10 %	Expressed by zeros if needed to complete the 3 digit block. A decimal point is indicated by an "R" (6R3 = 6.3 V).	See Ratings and Case Codes table	1, 2, 3, 4, 6, 9 See description on next page	A = Ammpack B = Reel pack, positive leader C = Reel pack, negative leader V = Bulk pack	E3 = 100 % tin termination (RoHS compliant design) Blank = SnPb termination (standard design)

LEAD STYLE CONFIGURATIONS AND DIMENSIONS (MAX.) in millimeters												
Bulk: Code V						Reel/Ammpack: Code A, B, C						
1 and 3 D max.		2 and 4 D max.		6 D max.		9 D max.		2 and 4 D max.		6 D max.		
H max.		H max.		H1 max.		H2 max.		H3 max.		H4 max.		
15 min. 20 max.		15 min. 20 max.		0.5		5.5 ± 0.5		0.5		4.5 ± 1.5		
P ± 0.5		P ± 0.5		P ± 0.5		1.1 ± 0.05		P ± 0.5		P ± 0.5		
Upper edge of Printed Circuit Board												
LEAD CASE	D	STYLES 1-2-3-4			STYLE 6		STYLE 9		STYLES 2-4		STYLE 6	
		P	H	P	H1	P	H2	P	H3	P	H4	
A	3.7	2.5	7.0	5	11.0	5	10.0	2.5	7.0	5	11.0	
B	4.0	2.5	7.5	5	11.5	5	10.5	2.5	7.5	5	11.5	
C	4.5	2.5	8.0	5	12.0	5	11.0	2.5	8.0	5	12.0	
D	5.0	2.5	9.0	5	13.0	5	12.0	2.5	9.0	5	13.0	
E	5.5	2.5	10.0	5	14.0	5	13.0	2.5	10.0	5	14.0	
F	6.0	2.5	11.0	5	15.0	5	14.0	2.5	11.0	5	15.0	
H	6.5	2.5	12.0	5	16.0	5	15.0	2.5	12.0	5	16.0	
M	10.0	5.0	14.5	-	-	5	18.0	5.0	14.5	-	-	
N	11.0	5.0	16.0	-	-	5	19.0	-	-	-	-	
R	12.0	5.0	19.0	-	-	5	22.0	-	-	-	-	

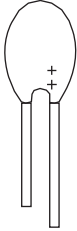
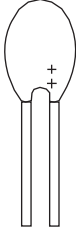
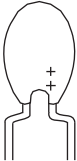
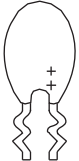
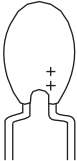
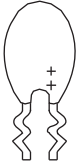
LEAD STYLE	
<p><b>LEAD STYLE 1:</b></p> <p>Straight leads, 2.5 mm lead space, uneven length</p> 	<p><b>LEAD STYLE 2:</b></p> <p>Straight leads, 2.5 mm lead space, even length</p> 
<p><b>LEAD STYLE 3:</b></p> <p>Straight leads, 5 mm lead space, uneven length</p> 	<p><b>LEAD STYLE 4:</b></p> <p>Straight leads, 5 mm lead space, even length</p> 
<p><b>LEAD STYLE 6:</b></p> <p>Shouldered leads, 5 mm lead space</p> 	<p><b>LEAD STYLE 9:</b></p> <p>Snap-In leads, 5 mm lead space</p> 

RATINGS, CASE CODES AND LEAD STYLE										
C <sub>R</sub> μF	RATED VOLTAGE U <sub>R</sub> AT + 85 °C								LEAD STYLE	
	3.0 V	6.3 V	10 V	16 V	20 V	25 V	35 V	50 V	BULK	AMMO/REEL
0.10							A	A		
0.15							A	A		
0.22							A	A		
0.33							A	B		
0.47							A	B	1 - 2	
0.68							B	C	6 - 9	2 - 6
1.0						A	B	D		
1.5					A	B	C	E		
2.2				A	B	B	C	F		
3.3			A	B	C	C	D	F		
4.7		A	A	B	C	C	D	H		
6.8	A	A	B	C	D	D	E	N		
10	B	B	B	C	D	D	F	N	3 - 4 - 9	4
15	B	B	C	D	E	E	M	N		
22	C	C	C	D	F	H	M	N		
33	C	C	D	E	H	M	N			
47	D	D	D	F	M	M	N			
68	D	D	E	M	N	N				
100	E	E	M	N	N					
150	H	M	M	N						
220	M	M	N	R						
330	N	N	R							
470	N	R								
680	R	R								



STANDARD RATINGS						
CAPACITANCE C <sub>R</sub> (μF)	CASE CODE	PART NUMBER	MAX. DCL	MAX. DCL	MAX. DF, 100 Hz	
			AT + 25 °C (μA) 489D	AT + 25 °C (μA) 499D	AT + 25 °C (%) 489D, 499D	
<b>U<sub>R</sub> = 3 V<sub>DC</sub> AT + 85 °C, SURGE = 4 V; U<sub>C</sub> = 2 V<sub>DC</sub> AT + 125 °C, SURGE = 2.6 V (ONLY 499D)</b>						
6.8	A	489D685X(*)003A__	1.0	0.5	6	
10	B	489D106X(*)003B__	1.0	0.5	8	
15	B	489D156X(*)003B__	1.0	0.5	8	
22	C	489D226X(*)003C__	1.0	0.5	8	
33	C	489D336X(*)003C__	1.4	0.7	8	
47	D	489D476X(*)003D__	2.1	1.1	8	
68	D	489D686X(*)003D__	3.0	1.6	8	
100	E	489D107X(*)003E__	4.5	2.4	10	
150	H	489D157X(*)003H__	6.7	3.6	10	
220	M	489D227X(*)003M__	9.9	5.2	10	
330	N	489D337X(*)003N__	14.8	7.9	10	
470	N	489D477X(*)003N__	21.1	11.2	12	
680	R	489D687X(*)003R__	30.6	16.3	12	
<b>U<sub>R</sub> = 6.3 V<sub>DC</sub> AT + 85 °C, SURGE = 8 V; U<sub>C</sub> = 4 V<sub>DC</sub> AT + 125 °C, SURGE = 5.2 V (ONLY 499D)</b>						
4.7	A	489D475X(*)6R3A__	1.0	0.5	6	
6.8	A	489D685X(*)6R3A__	1.0	0.5	6	
10	B	489D106X(*)6R3B__	1.0	0.5	8	
15	B	489D156X(*)6R3B__	1.4	0.7	8	
22	C	489D226X(*)6R3C__	2.0	1.1	8	
33	C	489D336X(*)6R3C__	3.1	1.6	8	
47	D	489D476X(*)6R3D__	4.4	2.3	8	
68	D	489D686X(*)6R3D__	6.4	3.4	8	
100	E	489D107X(*)6R3E__	9.4	5.0	10	
150	M	489D157X(*)6R3M__	14.1	7.5	10	
220	M	489D227X(*)6R3M__	20.7	11.0	10	
330	N	489D337X(*)6R3N__	31.1	16.6	10	
470	R	489D477X(*)6R3R__	44.4	23.6	12	
680	R	489D687X(*)6R3R__	64.2	34.2	12	
<b>U<sub>R</sub> = 10 V<sub>DC</sub> AT + 85 °C, SURGE = 13 V; U<sub>C</sub> = 7 V<sub>DC</sub> AT + 125 °C, SURGE = 8.6 V (ONLY 499D)</b>						
3.3	A	489D335X(*)010A__	1.0	0.5	6	
4.7	A	489D475X(*)010A__	1.0	0.5	6	
6.8	B	489D685X(*)010B__	1.0	0.5	6	
10	B	489D106X(*)010B__	1.5	0.8	8	
15	C	489D156X(*)010C__	2.2	1.2	8	
22	C	489D226X(*)010C__	3.3	1.7	8	
33	D	489D336X(*)010D__	4.9	2.6	8	
47	D	489D476X(*)010D__	7.0	3.7	8	
68	E	489D686X(*)010E__	10.2	5.4	8	
100	M	489D107X(*)010M__	15.0	8.0	10	
150	M	489D157X(*)010M__	22.5	12.0	10	
220	N	489D227X(*)010N__	33.0	17.6	10	
330	R	489D337X(*)010R__	49.5	26.4	10	

**Note**

489D Type part number 489D, 499D  
 (\*) Insert 0 for ± 20 % tolerance or 9 for ± 10 %  
 \_\_ Case code/lead style see case code table



STANDARD RATINGS						
CAPACITANCE $C_R$ ( $\mu$ F)	CASE CODE	PART NUMBER	MAX. DCL AT + 25 °C ( $\mu$ A) 489D	MAX. DCL AT + 25 °C ( $\mu$ A) 499D	MAX. DF, 100 Hz AT + 25 °C (%) 489D, 499D	
<b><math>U_R = 16 V_{DC}</math> AT + 85 °C, SURGE = 20 V; <math>U_C = 10 V_{DC}</math> AT + 125 °C, SURGE = 13 V (ONLY 499D)</b>						
2.2	A	489D225X(*)016A__	1.0	0.5	6	
3.3	B	489D335X(*)016B__	1.0	0.5	6	
4.7	B	489D475X(*)016B__	1.1	0.6	6	
6.8	C	489D685X(*)016C__	1.6	0.8	6	
10	C	489D106X(*)016C__	2.4	1.2	8	
15	D	489D156X(*)016D__	3.6	1.9	8	
22	D	489D226X(*)016D__	5.2	2.8	8	
33	E	489D336X(*)016E__	7.9	4.2	8	
47	F	489D476X(*)016F__	11.2	6.0	8	
68	M	489D686X(*)016M__	16.3	8.7	8	
100	N	489D107X(*)016N__	24.0	12.8	10	
150	N	489D157X(*)016N__	36.0	19.2	10	
220	R	489D227X(*)016R__	52.8	28.1	10	
<b><math>U_R = 20 V_{DC}</math> AT + 85 °C, SURGE = 26 V; <math>U_C = 13 V_{DC}</math> AT + 125 °C, SURGE = 16 V (ONLY 499D)</b>						
1.5	A	489D155X(*)020A__	1.0	0.5	4	
2.2	B	489D225X(*)020B__	1.0	0.5	6	
3.3	C	489D335X(*)020C__	1.0	0.5	6	
4.7	C	489D475X(*)020C__	1.4	0.7	6	
6.8	D	489D685X(*)020D__	2.0	1.0	6	
10	D	489D106X(*)020D__	3.0	1.6	8	
15	E	489D156X(*)020E__	4.5	2.4	8	
22	F	489D226X(*)020F__	6.6	3.5	8	
33	H	489D336X(*)020H__	9.9	5.2	8	
47	M	489D476X(*)020M__	14.1	7.5	8	
68	N	489D686X(*)020N__	20.4	10.8	8	
100	N	489D107X(*)020N__	30.0	16.0	10	
<b><math>U_R = 25 V_{DC}</math> AT + 85 °C, SURGE = 32 V; <math>U_C = 17 V_{DC}</math> AT + 125 °C, SURGE = 21 V (ONLY 499D)</b>						
1.0	A	489D105X(*)025A__	1.0	0.5	4	
1.5	B	489D155X(*)025B__	1.0	0.5	4	
2.2	B	489D225X(*)025B__	1.0	0.5	6	
3.3	C	489D335X(*)025C__	1.2	0.6	6	
4.7	C	489D475X(*)025C__	1.7	0.9	6	
6.8	D	489D685X(*)025D__	2.5	1.3	6	
10	D	489D106X(*)025D__	3.7	2.0	8	
15	E	489D156X(*)025E__	5.6	3.0	8	
22	H	489D226X(*)025H__	8.2	4.4	8	
33	M	489D336X(*)025M__	12.3	6.6	8	
47	M	489D476X(*)025M__	17.6	9.4	8	
68	N	489D686X(*)025N__	25.5	13.6	8	

**Note**

489D Type part number 489D, 499D  
 (\*) Insert 0 for  $\pm 20\%$  tolerance or 9 for  $\pm 10\%$   
 \_\_ Case code/lead style see case code table



STANDARD RATINGS						
CAPACITANCE C <sub>R</sub> (μF)	CASE CODE	PART NUMBER	MAX. DCL	MAX. DCL	MAX. DF, 100 Hz	
			AT + 25 °C (μA) 489D	AT + 25 °C (μA) 499D	AT + 25 °C (%) 489D, 499D	
<b>U<sub>R</sub> = 35 V<sub>DC</sub> AT + 85 °C, SURGE = 46 V; U<sub>C</sub> = 23 V<sub>DC</sub> AT + 125 °C, SURGE = 28 V (ONLY 499D)</b>						
0.10	A	489D104X(*)035A__	1.0	0.5	4	
0.15	A	489D154X(*)035A__	1.0	0.5	4	
0.22	A	489D224X(*)035A__	1.0	0.5	4	
0.33	A	489D334X(*)035A__	1.0	0.5	4	
0.47	A	489D474X(*)035A__	1.0	0.5	4	
0.68	B	489D684X(*)035B__	1.0	0.5	4	
1.0	B	489D105X(*)035B__	1.0	0.5	4	
1.5	C	489D155X(*)035C__	1.0	0.5	4	
2.2	C	489D225X(*)035C__	1.1	0.6	6	
3.3	D	489D335X(*)035D__	1.7	0.9	6	
4.7	D	489D475X(*)035D__	2.4	1.3	6	
6.8	E	489D685X(*)035E__	3.5	1.9	6	
10	F	489D106X(*)035F__	5.2	2.8	8	
15	M	489D156X(*)035M__	7.8	4.2	8	
22	M	489D226X(*)035M__	11.5	6.1	8	
33	N	489D336X(*)035N__	17.3	9.2	8	
47	N	489D476X(*)035N__	24.6	13.1	8	
<b>U<sub>R</sub> = 50 V<sub>DC</sub> AT + 85 °C, SURGE = 65 V; U<sub>C</sub> = 33 V<sub>DC</sub> AT + 125 °C, SURGE = 40 V (ONLY 499D)</b>						
0.10	A	489D104X(*)050A__	1.0	0.5	4	
0.15	A	489D154X(*)050A__	1.0	0.5	4	
0.22	A	489D224X(*)050A__	1.0	0.5	4	
0.33	B	489D334X(*)050B__	1.0	0.5	4	
0.47	B	489D474X(*)050B__	1.0	0.5	4	
0.68	C	489D684X(*)050C__	1.0	0.5	4	
1.0	D	489D105X(*)050D__	1.0	0.5	4	
1.5	E	489D155X(*)050E__	1.1	0.6	4	
2.2	F	489D225X(*)050F__	1.6	0.8	6	
3.3	F	489D335X(*)050F__	2.4	1.3	6	
4.7	H	489D475X(*)050H__	3.5	1.8	6	
6.8	N	489D685X(*)050N__	5.1	2.7	6	
10	N	489D106X(*)050N__	7.5	4.0	8	
15	N	489D156X(*)050N__	11.2	6.0	8	
22	N	489D226X(*)050N__	16.5	8.8	8	

**Note**

489D Type part number 489D, 499D  
 (\*) Insert 0 for ± 20 % tolerance or 9 for ± 10 %  
 \_\_ Case code/lead style see case code table

PACKAGING QUANTITIES											
CASE CODE	A	B	C	D	E	F	H	M	N	R	
BULK	500							100			
AMMOPACK	2500		2000			1500		500			
REEL PACK	2500		2000			1500		500			



PERFORMANCE CHARACTERISTICS

- 1. **Operating Temperature:** - 55 °C to + 85 °C with rated DC voltage  $U_R$  applied. + 85 °C to + 125° C with linear voltage derating to category voltage  $U_C$  for 499D only (see general information)
- 2. **Capacitance and Tolerance:** Capacitance measured at 100 Hz and + 25 °C shall be within the specified tolerance limits of the nominal rating. Capacitance measurement shall be made by means of a polarized capacitance bridge. No polarizing voltage is required. The maximum voltage applied during measurements shall be 0.5  $V_{RMS}$  at 100 Hz and + 25 °C.
- 3. **Reverse Voltage:** These capacitors are capable of withstanding peak voltage in the reverse direction equal to:
  - 15 % of the rated DC voltage at + 20 °C
  - 10 % of the rated DC voltage at + 25 °C
  - 5 % of the rated DC voltage at + 85 °C

4. Surge Voltage:

DC rated voltage at + 85 °C (V)	3	6.3	10	16	20	25	35	50
DC surge voltage at + 85 °C (V)	4	8	13	20	26	32	46	65
DC rated voltage at + 125 °C (V) <sup>(1)</sup>	2	4	7	10	13	17	23	33
DC surge voltage at + 125 °C (V) <sup>(1)</sup>	2.6	5.2	8.6	13	16	21	28	40

Note

<sup>(1)</sup>For 499D

Capacitors shall withstand the surge voltage applied in series with a 1000 Ω (± 5 %) resistor, at the rate of 1.5 min on, 5.5 min off for 1000 successive test cycles at + 85 °C. After test, capacitance change shall not exceed 10 % of initial value, dissipation factor and DC leakage current shall meet initial requirements at + 25 °C - Table 2.

5. Stability at low and high temperatures:

489D - Table 2A

TEMP.	CAPACITANCE CHANGE	DC LEAKAGE CURRENT <sup>(1)</sup>	DISSIPATION FACTOR AT 100 Hz	
- 55 °C	- 10 % of initial value	-----	$C_R \leq 1.5 \mu F$	4 % max
+ 25 °C	-----	0.015 $C_R \times U_R$ or 1 $\mu A$ , whichever is greater	1.5 $\mu F < C_R < 10 \mu F$	6 % max
+ 85 °C	+ 10 % of initial value	0.15 $C_R \times U_R$ or 10 $\mu A$ , whichever is greater	10 $\mu F < C_R < 100 \mu F$	8 % max
			100 $\mu F \leq C_R \leq 330 \mu F$	10 % max
			330 $\mu F < C_R$	12 % max

TEMP.	CAPACITANCE CHANGE	DC LEAKAGE CURRENT <sup>(1)</sup>	DISSIPATION FACTOR AT 100 Hz	
- 55 °C	- 10 % of initial value	-----	$C_R \leq 1.5 \mu F$	4 % max
+ 25 °C	-----	0.008 $C_R \times U_R$ or 0.5 $\mu A$ , whichever is greater	1.5 $\mu F < C_R < 10 \mu F$	6 % max
+ 85 °C	+ 10 % of initial value	0.08 $C_R \times U_R$ or 5 $\mu A$ , whichever is greater	10 $\mu F < C_R < 100 \mu F$	8 % max
+ 125 °C <sup>(2)</sup>	+ 10 % of initial value	0.1 $C_R \times U_R$ or 6.25 $\mu A$ , whichever is greater	100 $\mu F \leq C_R \leq 330 \mu F$	10 % max
			330 $\mu F < C_R$	12 % max

Notes

<sup>(1)</sup> Rated voltage applied for 5 min with a series resistor of 1000 Ω

<sup>(2)</sup> Only for 499 D

- 6. **Life Test:** After 2000 h at + 85 °C with rated DC voltage applied, or after 1000 h at + 125 °C. With derated DC voltage (only for 499D), capacitors shall meet the requirements in table below.

Capacitance change	Within ± 10 % of initial value
DC leakage current	Within initial requirements at + 25 °C
Dissipation factor	Within initial requirements at + 25 °C

- 7. **Humidity Test:** After 21 days (504 h) <sup>(1)</sup> at + 40 °C, 90 % to 95 % of relative humidity (per IEC 68-2-3) with no voltage applied, capacitors shall meet the requirements in table below.

Capacitance change	Within ± 5 % of initial value
DC leakage current	Within initial requirements at + 25 °C - Table 2
Dissipation factor	Within initial requirements at + 25 °C - Table 2

Note

<sup>(1)</sup>Humidity test is 56 days (1350 hours) for 499D

- 8. **Marking:** The capacitors shall be marked with the rated capacitance and the rated DC working voltage. A code may be used for both capacitance and voltage. Units rated at 6.3 volts are usually marked as 6 volts. The package shall be marked with full Vishay Sprague part number, date code and quantity.



**GUIDE TO APPLICATION**

1. **AC Ripple Current:** The maximum allowable ripple current shall be determined from the formula:

$$I_{RMS} = \sqrt{\frac{P}{R_{ESR}}}$$

where,

P = Power dissipation in W at + 25 °C as given below

R<sub>ESR</sub> = The capacitor Equivalent Series Resistance at the specified frequency

2. **AC Ripple Voltage:** The maximum allowable ripple voltage shall be determined from the formula:

$$V_{RMS} = \sqrt{\frac{P}{R_{ESR}}} \times Z$$

where,

Z = The capacitor impedance at the specified frequency

3. **AC Ripple Current or Voltage Derating Factor:** If these capacitors are to be operated at temperatures above + 25 °C, the permissible RMS ripple current or voltage shall be calculated using the derating factors in the table below:

TEMPERATURE	DERATING FACTOR
+ 25 °C	1.0
+ 55 °C	0.9
+ 85 °C	0.8
+ 125 °C	0.4

4. **Power Dissipation:** Power dissipation will be affected by the heat sinking capability of the mounting surface. Non-sinusoidal ripple current may produce heating effects which differ from those shown in the following table. It is important that the equivalent I<sub>RMS</sub> value be established when calculating permissible operating levels.

CASE CODE	POWER DISSIPATION AT + 25 °C (W)
A	0.080
B	0.090
C	0.100
D	0.110
E	0.120
F	0.130
H	0.140
M	0.150
N	0.160
R	0.180

5. **Cleaning:** These capacitors are compatible with all commonly used solvents, such as TES, TMS, Prelete and Chloretane. Solvents containing methylene chloride or other epoxy solvents should be avoided since these will attack the epoxy encapsulation material.

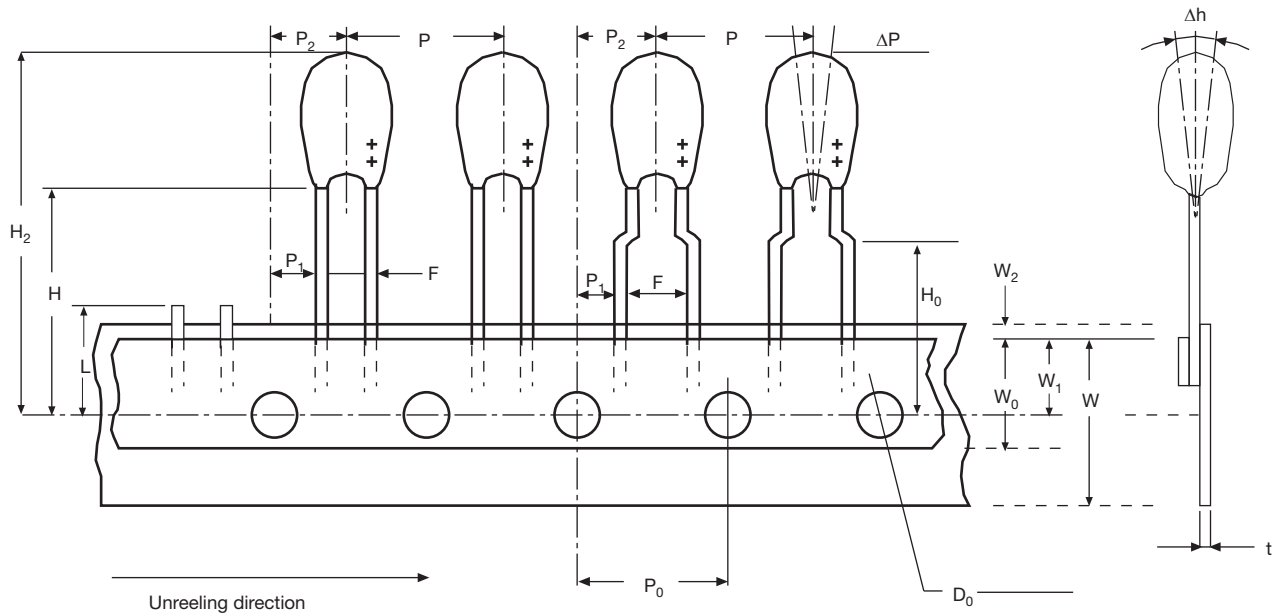
**TAPE AND REEL PACKAGING** in millimeters

Dimensions for components on tape and tolerances:

DESIGNATION	SYMBOL	DIMENSIONS (mm)	
Pitch of component	P	12.7 ± 1.0	
Feed hole pitch	P <sub>0</sub>	12.7 ± 0.3	
Tape width	W	18 (+ 1/- 0.5)	
Hold down tape width	W <sub>0</sub>	5.0	
Hole position	W <sub>1</sub>	9 (+ 0.75/- 0.5)	
Hold down tape position	W <sub>2</sub>	0 (+ 3/- 0)	
Overall component height	H <sub>1</sub>	32 max.	
Component alignment	ΔP	± 1.3 max.	
Feed hole diameter	D <sub>0</sub>	4.0 ± 0.3	
Tape thickness	t	0.5 ± 0.2	
Component alignment	ΔH	0 ± 2	
Length of snapped leads	L	11 max.	
Lead clinch height	H <sub>0</sub>	16.0 ± 0.5	
Lead wire spacing	F	2.5 (+ 0.6/-0.1)	5 (+ 0.6/-0.1)
Feed hole center to wire center	P <sub>1</sub>	5.1 ± 0.7	3.65 ± 0.7
Hole center to component center	P <sub>2</sub>	6.35 ± 1.3	6.35 ± 1.3
Component height	H	18 ± 1	





## Disclaimer

ALL PRODUCT, PRODUCT SPECIFICATIONS AND DATA ARE SUBJECT TO CHANGE WITHOUT NOTICE TO IMPROVE RELIABILITY, FUNCTION OR DESIGN OR OTHERWISE.

Vishay Intertechnology, Inc., its affiliates, agents, and employees, and all persons acting on its or their behalf (collectively, "Vishay"), disclaim any and all liability for any errors, inaccuracies or incompleteness contained in any datasheet or in any other disclosure relating to any product.

Vishay makes no warranty, representation or guarantee regarding the suitability of the products for any particular purpose or the continuing production of any product. To the maximum extent permitted by applicable law, Vishay disclaims (i) any and all liability arising out of the application or use of any product, (ii) any and all liability, including without limitation special, consequential or incidental damages, and (iii) any and all implied warranties, including warranties of fitness for particular purpose, non-infringement and merchantability.

Statements regarding the suitability of products for certain types of applications are based on Vishay's knowledge of typical requirements that are often placed on Vishay products in generic applications. Such statements are not binding statements about the suitability of products for a particular application. It is the customer's responsibility to validate that a particular product with the properties described in the product specification is suitable for use in a particular application. Parameters provided in datasheets and/or specifications may vary in different applications and performance may vary over time. All operating parameters, including typical parameters, must be validated for each customer application by the customer's technical experts. Product specifications do not expand or otherwise modify Vishay's terms and conditions of purchase, including but not limited to the warranty expressed therein.

Except as expressly indicated in writing, Vishay products are not designed for use in medical, life-saving, or life-sustaining applications or for any other application in which the failure of the Vishay product could result in personal injury or death. Customers using or selling Vishay products not expressly indicated for use in such applications do so at their own risk. Please contact authorized Vishay personnel to obtain written terms and conditions regarding products designed for such applications.

No license, express or implied, by estoppel or otherwise, to any intellectual property rights is granted by this document or by any conduct of Vishay. Product names and markings noted herein may be trademarks of their respective owners.

## Material Category Policy

**Vishay Intertechnology, Inc. hereby certifies that all its products that are identified as RoHS-Compliant fulfill the definitions and restrictions defined under Directive 2011/65/EU of The European Parliament and of the Council of June 8, 2011 on the restriction of the use of certain hazardous substances in electrical and electronic equipment (EEE) - recast, unless otherwise specified as non-compliant.**

**Please note that some Vishay documentation may still make reference to RoHS Directive 2002/95/EC. We confirm that all the products identified as being compliant to Directive 2002/95/EC conform to Directive 2011/65/EU.**

**Vishay Intertechnology, Inc. hereby certifies that all its products that are identified as Halogen-Free follow Halogen-Free requirements as per JEDEC JS709A standards. Please note that some Vishay documentation may still make reference to the IEC 61249-2-21 definition. We confirm that all the products identified as being compliant to IEC 61249-2-21 conform to JEDEC JS709A standards.**

## X-ON Electronics

Largest Supplier of Electrical and Electronic Components

*Click to view similar products for [Tantalum Capacitors - Solid SMD category:](#)*

*Click to view products by [Vishay manufacturer:](#)*

Other Similar products are found below :

[B45197-A2157-M509](#) [B45197A5226M409](#) [293D686X0020E8T](#) [CWR09JC105KCB\M100](#) [CWR11CH107KBA](#) [TCSCS1A336KBAR](#) [419-2060-501](#) [B45196-H5106-K309](#) [B45196-H6226-K509](#) [CWR29JC106KBEZ](#) [T83D475K050RCCL](#) [591D158X06R3R2T20H](#) [M39006/22-0640H](#) [M39003/01-2596](#) [TCSCS1A476KBAR](#) [T83E107K016RCCL](#) [T83D685K035RCCL](#) [293D475X0035B2DE3](#) [TMCMB1C475KTRF](#) [293D155X9020A2DE3](#) [298W476X06R3M2T](#) [298W107X0004M2T](#) [CWR29NC225KDFC](#) [CWR29HH155KCBB](#) [CWR29HC106KCDC](#) [293D476X9035E2TE3](#) [CWR29KC226JCGC](#) [T495D156K025ATE2757005](#) [T513X227K016BH4585](#) [CWR29DC337KCHC](#) [T97H107M040HSA](#) [595D686X9010B2T](#) [T25D337M016CSZ](#) [591D156X9025R8T15H](#) [594D686X9016C2T](#) [595D106X0025C8T](#) [CWR29DC226KBDA\TR](#) [CWR29FC106KBBA\TR](#) [CWR29FC686KBGA\TR](#) [CWR29FC157KBXA\TR](#) [CWR29HC105KBAA\TR](#) [CA55-B6R3M107T](#) [CA55-E025M107T](#) [TC212B475K035Y](#) [TAZH685K035LBSB0824](#) [TAZG107K010LBSB0800](#) [TAZH475K050LBSB0H23](#) [TAZH156K025CBSZ0824](#) [TBJD156K025CBSZ0824](#) [TMCSA1V154MTRF](#)