



# Data and Signal Line Chokes

**Series/Type: B82796C0, B82796S0**

The following products presented in this data sheet are being withdrawn.

Ordering Code	Substitute Product	Date of Withdrawal	Deadline Last Orders	Last Shipments
B82796S0513N201		2015-07-10	2015-12-31	2016-03-31
B82796S0253N201		2015-07-10	2015-12-31	2016-03-31
B82796C0502N201		2015-07-10	2015-12-31	2016-03-31



Ordering Code	Substitute Product	Date of Withdrawal	Deadline Last Orders	Last Shipments
B82796C0475N265		2015-07-10	2015-12-31	2016-03-31
B82796C0474N215		2015-07-10	2015-12-31	2016-03-31
B82796C0225N265		2015-07-10	2015-12-31	2016-03-31
B82796C0113N201		2015-07-10	2015-12-31	2016-03-31
B82796C0105N265		2015-07-10	2015-12-31	2016-03-31

For further information please contact your nearest EPCOS sales office, which will also support you in selecting a suitable substitute. The addresses of our worldwide sales network are presented at [www.epcos.com/sales](http://www.epcos.com/sales).

**Rated voltage 42 V AC/80 V DC**

**Rated inductance 0.005 mH to 4.7 mH**

**Rated current 0.4 A to 1.2 A**

### Construction

- Current-compensated ring core double choke
- Ferrite core
- Polycarbonate case (UL 94 V-0)
- Silicone potting
- Bifilar winding (B82796C0)
- Sector winding (B82796S0)

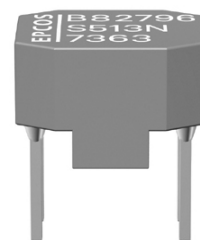

### Features

- Suitable for automatic insertion
- Suitable for wave soldering
- RoHS-compatible

### Applications

- B82796C0:  
Suppression of asymmetrical interference coupled in on lines, whereas data signals up to some MHz can pass unaffectedly.
- B82796S0:  
Suppression of asymmetrical and symmetrical interference coupled in on lines. The high-frequency portions of the symmetrical data signal are decreased so far that EMC problems can be significantly reduced.

### Terminals

- Base material CuNi18Zn20
- Layer composition Ni, Sn
- Hot-dipped
- Lead spacing 6 × 2.5 (mm)

### Marking

Manufacturer, ordering code (short form),  
date of manufacture (YWWDD)

### Packing

Cardboard box

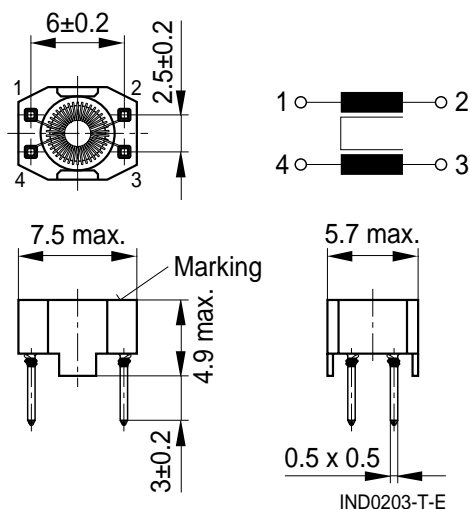
**Dimensional drawing and pin configuration**

Tolerances to ISO 2768-M  
unless otherwise noted.

Dimensions in mm

**Technical data and measuring conditions**

Rated voltage $V_R$	42 V AC (50/60 Hz) / 80 V DC
Rated temperature $T_R$	60 °C
Rated current $I_R$	Referred to 50 Hz and rated temperature
Rated inductance $L_R$	Measured with Agilent 4284A at 0.1 mA, 20 °C Measuring frequency: $L_R \leq 1 \text{ mH} = 100 \text{ kHz}$ $L_R > 1 \text{ mH} = 10 \text{ kHz}$ Inductance is specified per winding.
Inductance tolerance	-30%/+50% at 20 °C
Inductance decrease $\Delta L/L_0$	< 10% at DC magnetic bias with $I_R$ , 20 °C
Stray inductance $L_{\text{stray,typ}}$	Measured with Agilent 4284A at 5 mA, 20 °C, typical values Measuring frequency: $L_R \leq 11 \mu\text{H} = 1 \text{ MHz}$ $L_R > 11 \mu\text{H} = 100 \text{ kHz}$
DC resistance $R_{\text{typ}}$	Measured at 20 °C, typical values, specified per winding
Solderability (lead-free)	Sn96.5Ag3.0Cu0.5: (245 ±5) °C, (3 ±0.3) s Wetting of soldering area ≥ 95% (to IEC 60068-2-20, test Ta)
Resistance to soldering heat (wave soldering)	(260 ±5) °C, (10 ±1) s (to IEC 60068-2-20, test Tb)
Climatic category	40/125/56 (to IEC 60068-1)
Storage conditions (packaged)	-25 °C ... +40 °C, ≤ 75% RH
Weight	Approx. 0.25 g

**Characteristics and ordering codes**

$L_R$ mH	$L_{\text{stray,typ}}$ nH	$I_R^{1)}$ mA	$R_{\text{typ}}$ m $\Omega$	$V_{\text{test}}$ V DC, 2 s	Ordering code
0.005	40	1200	60	250	B82796C0502N201
0.011	50	800	70	250	B82796C0113N201
0.025	1400	800	100	250	B82796S0253N201
0.051	2000	800	140	250	B82796S0513N201
0.470	120	700	170	750	B82796C0474N215
1.0	100	700	160	750	B82796C0105N265
2.2	150	500	420	750	B82796C0225N265
4.7	200	400	520	750	B82796C0475N265

**Insertion loss  $\alpha$**  (typical values at  $|Z| = 50 \Omega$ , 20 °C)

————— asymmetrical, all branches in parallel (common mode)

- - - - - symmetrical (differential mode)

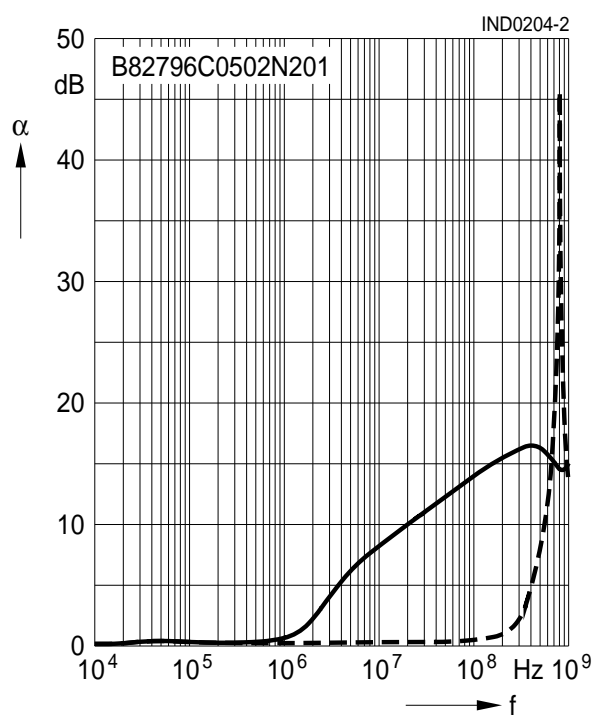
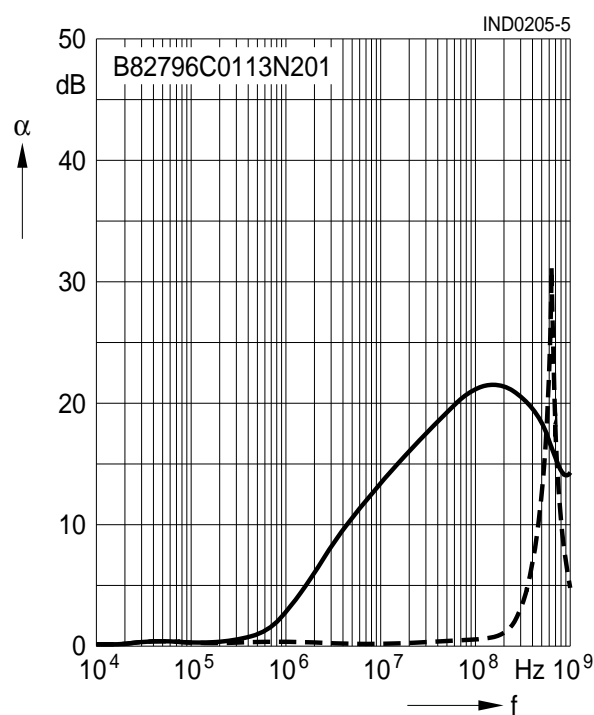
 $L_R = 0.005 \text{ mH}$ 

 $L_R = 0.011 \text{ mH}$ 

1) Types with higher rated current on request.

Common-mode chokes, ring core

Insertion loss  $\alpha$  (typical values at  $|Z| = 50 \Omega$ ,  $20^\circ\text{C}$ )

———— asymmetrical, all branches in parallel (common mode)

- - - - - symmetrical (differential mode)

$L_R = 0.025 \text{ mH}$

$L_R = 0.051 \text{ mH}$

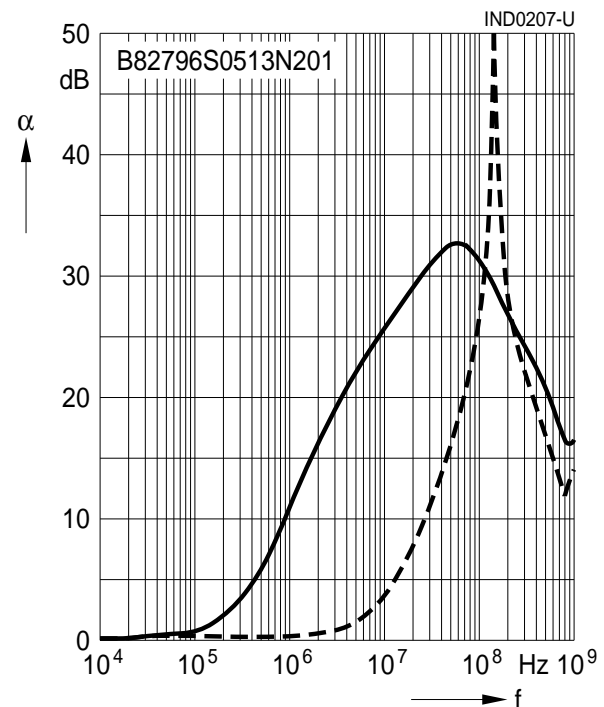
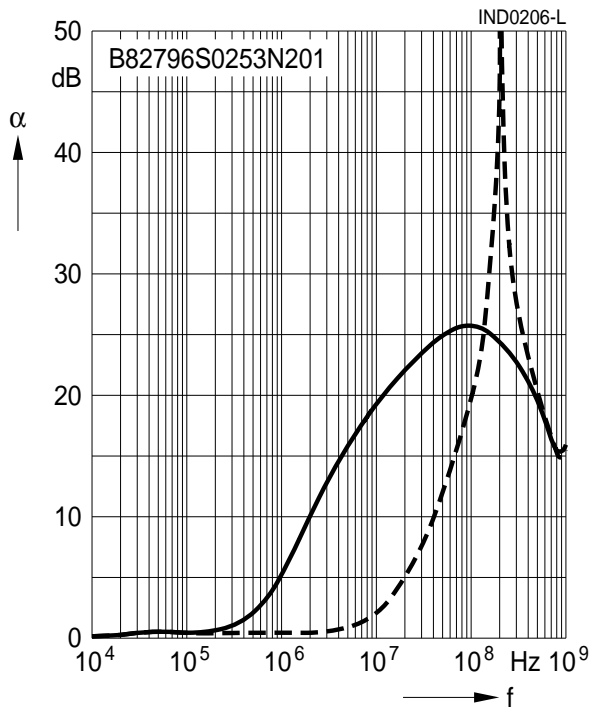

$L_R = 0.47 \text{ mH}$

$L_R = 1.0 \text{ mH}$

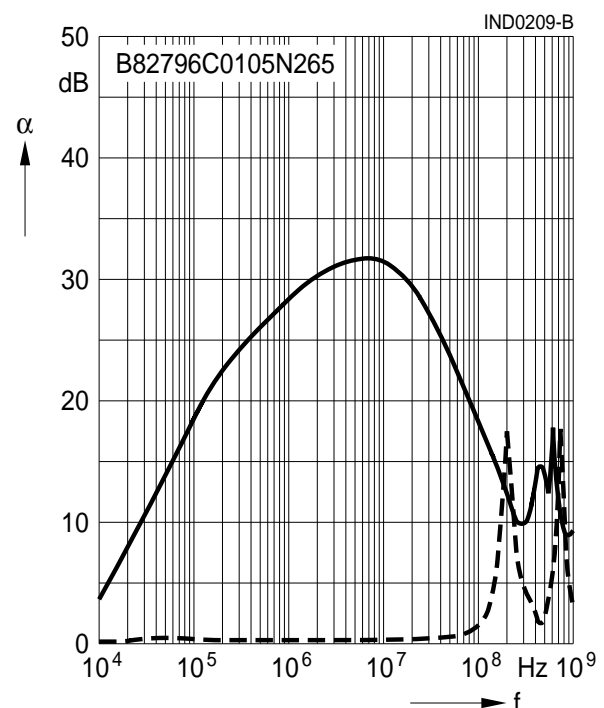
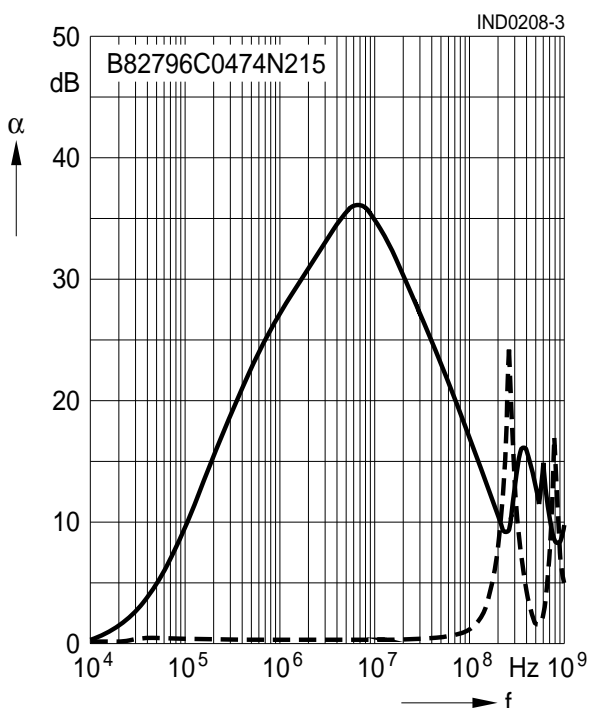

Insertion loss  $\alpha$  (typical values at  $|Z| = 50 \Omega$ ,  $20^\circ\text{C}$ )

———— asymmetrical, all branches in parallel (common mode)

- - - - - symmetrical (differential mode)

$L_R = 2.2 \text{ mH}$

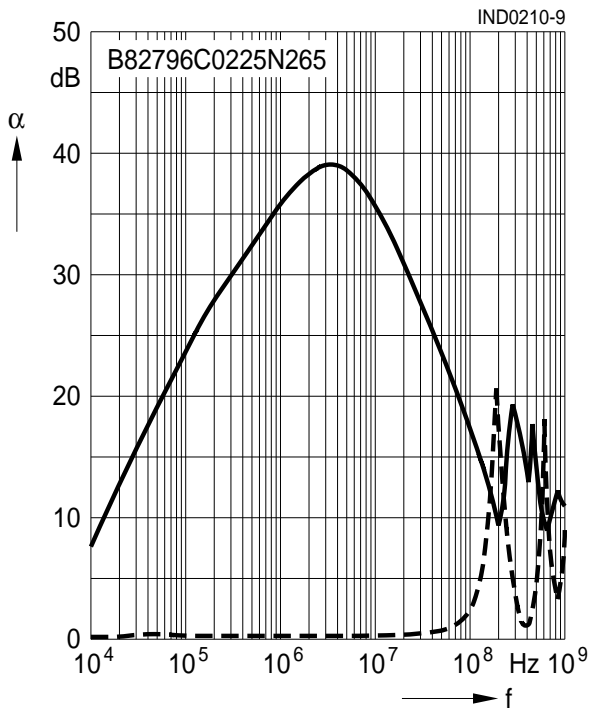

$L_R = 4.7 \text{ mH}$

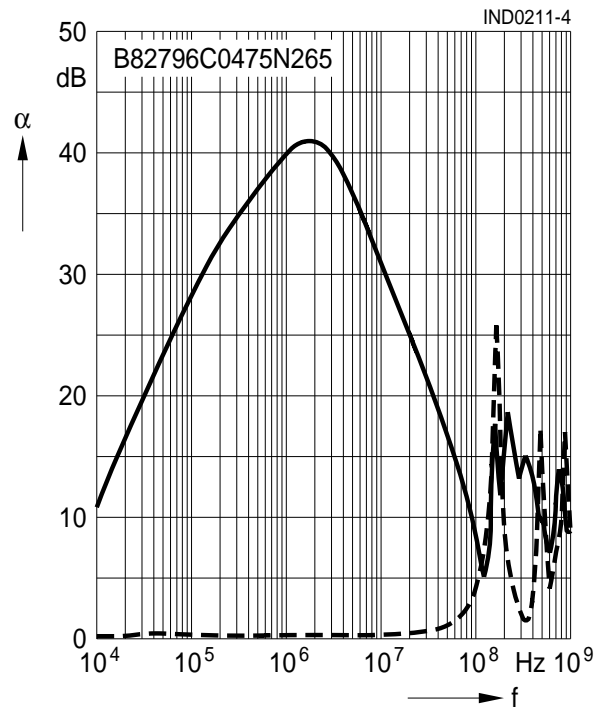

Current derating  $I_{op}/I_R$   
versus ambient temperature

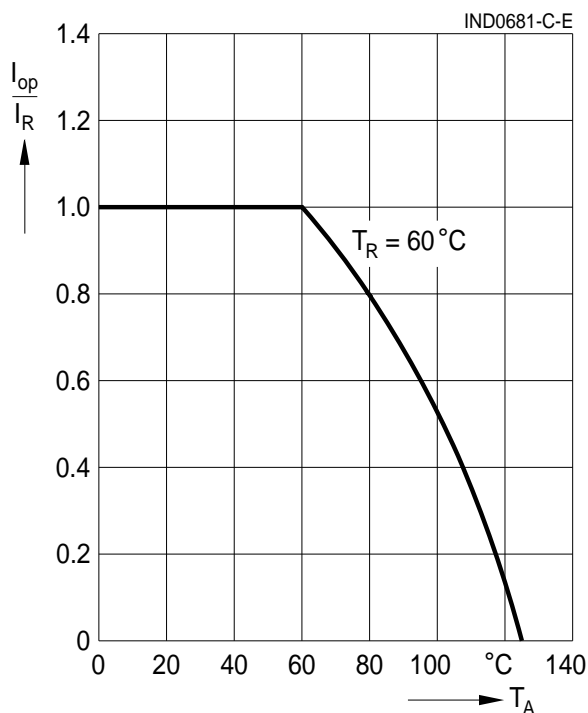

## Cautions and warnings

- Please note the recommendations in our Inductors data book (latest edition) and in the data sheets.
  - Particular attention should be paid to the derating curves given there.
  - The soldering conditions should also be observed. Temperatures quoted in relation to wave soldering refer to the pin, not the housing.
- If the components are to be washed varnished it is necessary to check whether the washing varnish agent that is used has a negative effect on the wire insulation, any plastics that are used, or on glued joints. In particular, it is possible for washing varnish agent residues to have a negative effect in the long-term on wire insulation.
- The following points must be observed if the components are potted in customer applications:
  - Many potting materials shrink as they harden. They therefore exert a pressure on the plastic housing or core. This pressure can have a deleterious effect on electrical properties, and in extreme cases can damage the core or plastic housing mechanically.
  - It is necessary to check whether the potting material used attacks or destroys the wire insulation, plastics or glue.
  - The effect of the potting material can change the high-frequency behaviour of the components.
- Ferrites are sensitive to direct impact. This can cause the core material to flake, or lead to breakage of the core.
- Even for customer-specific products, conclusive validation of the component in the circuit can only be carried out by the customer.



## Important notes

The following applies to all products named in this publication:

1. Some parts of this publication contain **statements about the suitability of our products for certain areas of application**. These statements are based on our knowledge of typical requirements that are often placed on our products in the areas of application concerned. We nevertheless expressly point out **that such statements cannot be regarded as binding statements about the suitability of our products for a particular customer application**.

As a rule, EPCOS is either unfamiliar with individual customer applications or less familiar with them than the customers themselves. For these reasons, it is always ultimately incumbent on the customer to check and decide whether an EPCOS product with the properties described in the product specification is suitable for use in a particular customer application.

2. We also point out that **in individual cases, a malfunction of electronic components or failure before the end of their usual service life cannot be completely ruled out in the current state of the art, even if they are operated as specified**. In customer applications requiring a very high level of operational safety and especially in customer applications in which the malfunction or failure of an electronic component could endanger human life or health (e.g. in accident prevention or life-saving systems), it must therefore be ensured by means of suitable design of the customer application or other action taken by the customer (e.g. installation of protective circuitry or redundancy) that no injury or damage is sustained by third parties in the event of malfunction or failure of an electronic component.

3. **The warnings, cautions and product-specific notes must be observed.**

4. In order to satisfy certain technical requirements, **some of the products described in this publication may contain substances subject to restrictions in certain jurisdictions (e.g. because they are classed as hazardous)**. Useful information on this will be found in our Material Data Sheets on the Internet ([www.epcos.com/material](http://www.epcos.com/material)). Should you have any more detailed questions, please contact our sales offices.

5. We constantly strive to improve our products. Consequently, **the products described in this publication may change from time to time**. The same is true of the corresponding product specifications. Please check therefore to what extent product descriptions and specifications contained in this publication are still applicable before or when you place an order.

We also **reserve the right to discontinue production and delivery of products**. Consequently, we cannot guarantee that all products named in this publication will always be available.

The aforementioned does not apply in the case of individual agreements deviating from the foregoing for customer-specific products.

6. Unless otherwise agreed in individual contracts, **all orders are subject to the current version of the “General Terms of Delivery for Products and Services in the Electrical Industry” published by the German Electrical and Electronics Industry Association (ZVEI)**.

7. The trade names EPCOS, BAOKE, Alu-X, CeraDiode, CSMP, CSSP, CTVS, DSSP, MiniBlue, MKK, MLSC, MotorCap, PCC, PhaseCap, PhaseCube, PhaseMod, SIFERRIT, SIFI, SIKOREL, SilverCap, SIMDAD, SIMID, SineFormer, SIOV, SIP5D, SIP5K, ThermoFuse, WindCap are **trademarks registered or pending** in Europe and in other countries. Further information will be found on the Internet at [www.epcos.com/trademarks](http://www.epcos.com/trademarks).

## X-ON Electronics

Largest Supplier of Electrical and Electronic Components

*Click to view similar products for [Common Mode Filters / Chokes](#) category:*

*Click to view products by [EPCOS](#) manufacturer:*

Other Similar products are found below :

[74279408](#) [8109-RC](#) [8121-RC](#) [PE-62911NL](#) [PE-64683](#) [RD5122-6-9M6](#) [RD6137-6-7M5](#) [RD8147-16-3M0](#) [B82722A2801N020](#)  
[B82723A2802N001](#) [B82723J2802N001](#) [B82726S2183N020](#) [T8114NLT](#) [RD5122-10-6M0](#) [RD7147-25-0M7](#) [B82724J2502U040](#)  
[B82725S2103N004](#) [B82731M2401A033](#) [B82792C0506N365](#) [IND-0110](#) [CMC-03](#) [8117-RC](#) [PE-67531](#) [B82732R2601B30](#)  
[B82794C0686N465](#) [2752041447](#) [2752045447](#) [CMS3-11-R](#) [23Z109SMNL-T](#) [009968H](#) [014660H](#) [057966E](#) [CM9900-224](#) [CPFC74NP-](#)  
[PS01H2A30](#) [CPFC805NP-100M05](#) [EXC-24CD121U](#) [EXC-24CD201U](#) [EXC-24CD600U](#) [B82723A2602N001](#) [B82730U3162A020](#)  
[B82730U3951A020](#) [DKFP-6248-0102](#) [DKFP-6248-02D5](#) [DKFP-6248-D504](#) [7448640395](#) [ELF-14M080E](#) [ELF-18D214](#) [ELF-18D217](#) [ELF-](#)  
[18D218](#) [ELF-18D227F](#)