

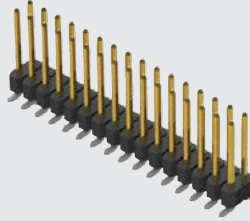

TSM-116-02-S-DV-LC

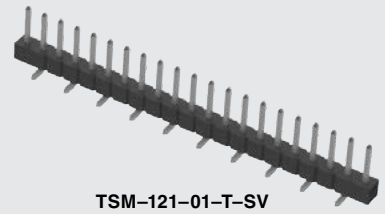

TSM-121-01-T-SV



(2.54 mm) .100"

SMT .025" SQ POST HEADER

Board Mates:

SSW, SSQ, SSM, BSW, ESW, ESQ, BCS, SLW, CES, HLE

Cable Mates:

IDSS, IDSD, SMSD, SMSS

SPECIFICATIONS

For complete specifications and recommended PCB layouts see www.samtec.com?TSM

Insulator Material:

Black Liquid Crystal Polymer

Terminal Material:

Phosphor Bronze

Plating:

Au or Sn over 50 μm (1.27 μm) Ni

Operating Temp Range:

-55 °C to +105 °C with Tin; -55 °C to +125 °C with Gold

Voltage Rating:

475 VAC -SV/-DV mated with BCS or SSM

RoHS Compliant:

Yes

Lead-Free Solderable:

Yes

-DH/-SH Lead Coplanarity:

(0.15 mm) .006" max (02-36)

-DV/-SV Lead Coplanarity:

(0.10 mm) .004" max (02-05)

(0.13 mm) .005" max (06-10)

(0.15 mm) .006" max (11-36)

MATES	CURRENT RATING (PER PIN)
TSM/SSW	4.7 A
TSM/SSM	5.4 A
TSM/HLE	4.1 A
1 PIN POWERED PER ROW	

TSM	1	NO. PINS PER ROW	LEAD STYLE	PLATING OPTION	ROW OPTION
		02 thru 36		-F = Gold flash on post, Matte Tin on tail	
				-L = 10 μm (0.25 μm) Gold on post, Matte Tin on tail	
				-S = 30 μm (0.76 μm) Gold on post, Matte Tin on tail	
				-T = Matte Tin	

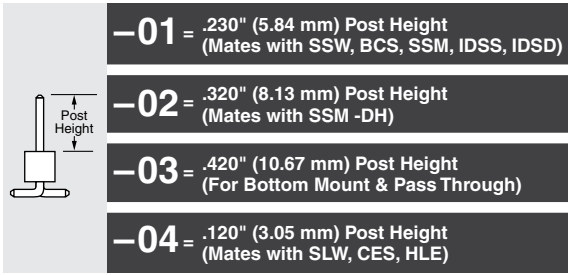

-SV = Single Row Vertical Pin

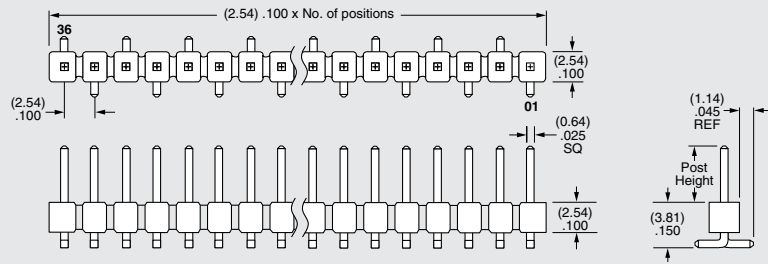

-SH = Single Row Horizontal Pin

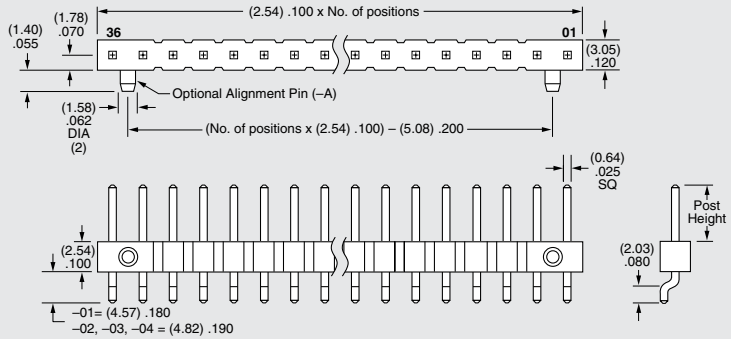

APPLICATIONS

SSM TSM

HORIZONTAL

RECOGNITIONS

For complete scope of recognitions see www.samtec.com/quality



ALSO AVAILABLE (MOQ Required)

- Edge Mount and Locking Clips for -SV
 - Solder Locks for -DH and Shrouds for -DV
 - Other platings
- Contact Samtec.

Note: Some lengths, styles and options are non-standard, non-returnable.

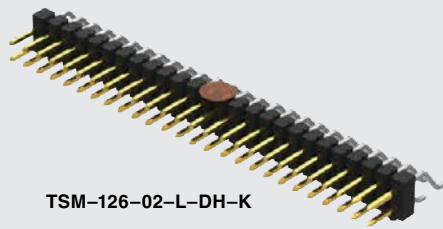

TSM-126-02-L-DH-K

TSM-115-01-T-SH-A

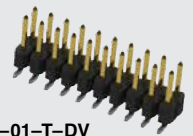
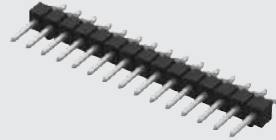

TSM-110-01-T-DV

TSM SERIES

OTHER OPTIONS

-A

= Alignment Pin metal or plastic at Samtec discretion (Not available with -TM or -MT) (02 positions min.) (Not available with -LC)

-LC

= Locking Clip (Not available with -TM) (3 positions min.) (Not available with -A) (Manual placement required)

-K

= (6.50 mm) .256" DIA Polyimide Film Pick & Place Pad (-SH: 4 positions minimum without -TR; 2 & 3 positions available with -TR) (-DH: 4 positions minimum without -TR)

-“XXX”

= Polarized Position

-P

= Plastic Pick & Place Pad (-DV: 4 positions minimum without -TR; 2 & 3 positions available with -TR) (-SH: 4 positions minimum without -TR; 2 & 3 positions available with -TR) (-DH: 5 positions minimum without -TR) (-SV: 4 positions minimum without -TR; 2 & 3 positions available with -TR)

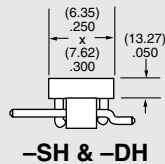
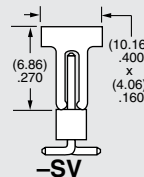

-TR

= Tape & Reel Packaging -SV = 02-22 positions -DV = 02-28 positions -SH = 02-30 positions -DH = 02-29 positions Not available with -MT or -TM

-DV

= Double Row Vertical Pin

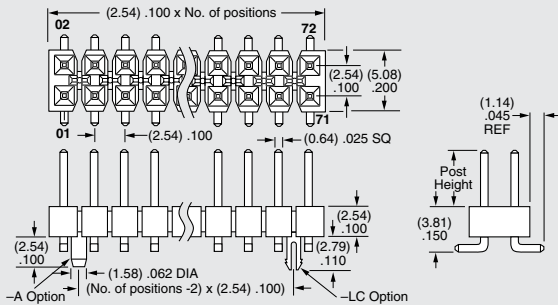

-TM

= Triple Row Vertical Mixed Technology (Style -01 only)

02 thru 30 positions only

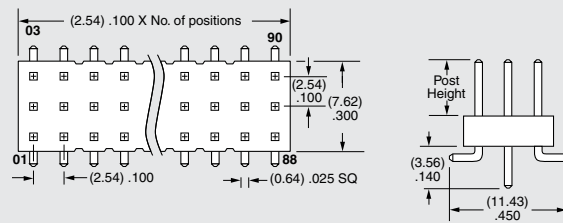

-DH

= Double Row Horizontal Pin (Style -01, -02 or -03 only)

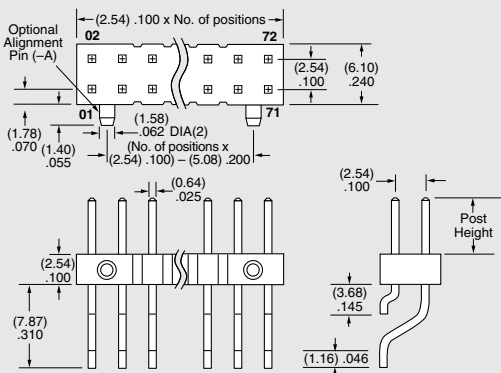

-MT

= Mixed Technology Pin (Style -01, -02 or -03 only)

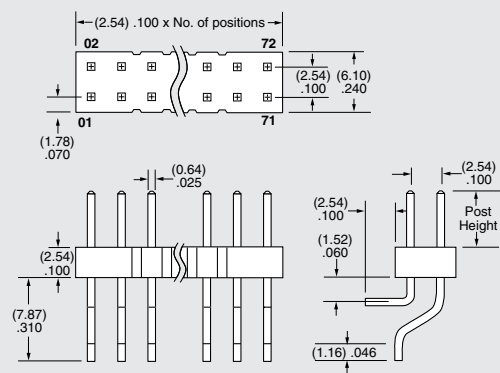

X-ON Electronics

Largest Supplier of Electrical and Electronic Components

Click to view similar products for [samtec](#) manufacturer:

Other Similar products are found below :

[ESQT-135-03-F-D-380](#) [FTSH-111-01-L-DV](#) [QTE-060-01-L-D-A](#) [MSAS-179-ZUGG-18](#) [MTSW-103-07-F-S-240](#) [MTSW-125-24-H-D-285](#)
[ERF8-020-05.0-S-DV-K-TR](#) [IDMD-10-T-12.00-A-G-R](#) [IPL1-112-01-L-D-K](#) [SFM-107-02-S-D-LC](#) [SFML-115-01-S-D](#) [SFML-125-01-S-D](#)
[LSHM-120-02.5-L-DV-A-N-K-TR](#) [ESQ-110-14-G-D](#) [ESQT-125-03-F-D-310](#) [SO-0515-01-01-02](#) [SQW-120-01-F-D-VS-A](#) [FJH-50-D-12.00-4](#)
[CES-150-01-T-D](#) [QFS-052-01-SL-D-RA](#) [QTE-040-04-L-D-A](#) [QTH-020-04-F-D-DP-A-K-TR](#) [QTH-060-01-F-D-A](#) [QTH-090-04-L-D-A](#)
[TCSD-10-S-05.00-01-F-N](#) [TFM-110-02-S-D](#) [TFM-115-02-L-DH](#) [TFM-120-12-S-D-LC](#) [TFML-140-02-S-D](#) [TLW-107-05-G-D](#) [BDL-136-T-E](#)
[TSS-132-01-G-S](#) [TST-113-04-S-D-RA](#) [TSW-105-14-F-D](#) [BSE-040-01-F-D-A](#) [HPF-03-02-T-S](#) [IPD1-04-D-K](#) [TW-03-06-H-D-400-SM-A](#)
[RPCU-G-00.50-BMS-AM](#) [ERF8-020-01-L-D-RA-L-TR](#) [ERF8-025-05.0-L-DV-TR](#) [ERF8-040-05.0-L-DV-TR](#) [SL-120-T-10](#) [SLM-115-01-S-D](#)
[CLP-132-02-G-D](#) [TFC-125-02-F-D-A-K](#) [ISDF-25-D-M](#) [IPT1-105-01-S-D-RA](#) [IPL1-125-01-S-D-RA](#) [ICO-308-CGT](#)