

## Features

- Small Surface Mount Package
- Ideally Suited for Automated Assembly Processes
- **Totally Lead-Free & Fully RoHS Compliant (Notes 1 & 2)**
- **Halogen and Antimony Free. "Green" Device (Note 3)**
- **Qualified to AEC-Q101 Standards for High Reliability**

## Mechanical Data

- Case: SOT323
- Case Material: Molded Plastic, "Green" Molding Compound. UL Flammability Classification Rating 94V-0
- Moisture Sensitivity: Level 1 per J-STD-020D
- Terminals: Matte Tin Finish annealed over Alloy 42 leadframe (Lead Free Plating). Solderable per MIL-STD-202, Method 208 ③
- Polarity: See Diagram
- Weight: 0.006 grams (approximate)

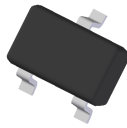

Top View

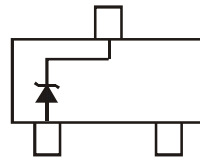

Device Schematic

## Ordering Information (Note 4)

Device	Packaging	Shipping
(Type Number)-7-F*	SOT323	3000/Tape & Reel

\* Add "-7-F" to the appropriate type number in Electrical Characteristics Table from Page 2. Example: 6.2V Zener = MMBZ5234BW-7-F.

- Notes:
1. No purposely added lead. Fully EU Directive 2002/95/EC (RoHS) & 2011/65/EU (RoHS 2) compliant.
  2. See [http://www.diodes.com/quality/lead\\_free.html](http://www.diodes.com/quality/lead_free.html) for more information about Diodes Incorporated's definitions of Halogen- and Antimony-free, "Green" and Lead-free.
  3. Halogen- and Antimony-free "Green" products are defined as those which contain <900ppm bromine, <900ppm chlorine (<1500ppm total Br + Cl) and <1000ppm antimony compounds.
  4. For packaging details, go to our website at <http://www.diodes.com/products/packages.html>.

## Marking Information (Note 5)

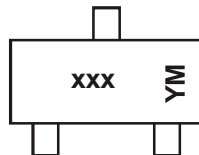

xxx = Product Type Marking Code  
(See Electrical Characteristics Table)  
YM = Date Code Marking  
Y = Year (ex: B = 2014)  
M = Month (ex: 9 = September)

### Date Code Key

Year	2007	2008	2009	2010	2011	2012	2013	2014	2015	2016	2017	2018
Code	U	V	W	X	Y	Z	A	B	C	D	E	F

Month	Jan	Feb	Mar	Apr	May	Jun	Jul	Aug	Sep	Oct	Nov	Dec
Code	1	2	3	4	5	6	7	8	9	O	N	D

Note: 5. Product manufactured with date code 0627 (week 27, 2006) and newer are built with Green Molding Compound. Product manufactured prior to date code 0627 are built with Non-Green Molding Compound and may contain Halogens or Sb2O3 Fire Retardants.

**Maximum Ratings** (@ $T_A = +25^\circ\text{C}$ , unless otherwise specified.)

Characteristic	Symbol	Value	Unit
Forward Voltage @ $I_F = 10\text{mA}$	$V_F$	0.9	V

**Thermal Characteristics**

Characteristic	Symbol	Value	Unit
Power Dissipation (Note 6)	$P_D$	200	mW
Thermal Resistance, Junction to Ambient Air (Note 6)	$R_{\theta JA}$	625	$^\circ\text{C/W}$
Operating and Storage Temperature Range	$T_J, T_{STG}$	-65 to +150	$^\circ\text{C}$

Notes: 6. Mounted on FR4 PC Board with recommended pad layout which can be found on our website at <http://www.diodes.com/datasheets/ap02001.pdf>.

**Electrical Characteristics** (@ $T_A = +25^\circ\text{C}$ , unless otherwise specified.)

Type Number	Marking Code	Zener Voltage Range (Note 7)			Test Current	Maximum Zener Impedance (Note 8)		Maximum Reverse Leakage Current (Note 7)	
		$V_Z @ I_{ZT}$				$I_{ZT}$	$Z_{ZT} @ I_{ZT}$	$Z_{ZK} @ I_{ZK} = 0.25\text{mA}$	$I_R$
		Nom (V)	Min (V)	Max (V)	mA	$\Omega$		$\mu\text{A}$	V
MMBZ5221BW	KC1	2.4	2.28	2.52	20	30	1200	100	1.0
MMBZ5223BW	KC3	2.7	2.57	2.84	20	30	1300	75	1.0
MMBZ5225BW	KC5	3.0	2.85	3.15	20	30	1600	50	1.0
MMBZ5226BW	KG1	3.3	3.14	3.47	20	28	1600	25	1.0
MMBZ5227BW	KG2	3.6	3.42	3.78	20	24	1700	15	1.0
MMBZ5228BW	KG3	3.9	3.71	4.10	20	23	1900	10	1.0
MMBZ5229BW	KG4	4.3	4.09	4.52	20	22	2000	5.0	1.0
MMBZ5230BW	KG5	4.7	4.47	4.94	20	19	1900	5.0	2.0
MMBZ5231BW	KE1	5.1	4.85	5.36	20	17	1600	5.0	2.0
MMBZ5232BW	KE2	5.6	5.32	5.88	20	11	1600	5.0	3.0
MMBZ5233BW	KE3	6	5.70	6.30	20	7.0	1600	5.0	3.5
MMBZ5234BW	KE4	6.2	5.89	6.51	20	7.0	1000	5.0	4.0
MMBZ5235BW	KE5	6.8	6.46	7.14	20	5.0	750	3.0	5.0
MMBZ5236BW	KF1	7.5	7.13	7.88	20	6.0	500	3.0	6.0
MMBZ5237BW	KF2	8.2	7.79	8.61	20	8.0	500	3.0	6.5
MMBZ5238BW	KF3	8.7	8.27	9.14	20	8	600	3	6.5
MMBZ5239BW	KF4	9.1	8.65	9.56	20	10	600	3.0	7.0
MMBZ5240BW	KF5	10	9.50	10.50	20	17	600	3.0	8.0
MMBZ5241BW	KH1	11	10.45	11.55	20	22	600	2.0	8.4
MMBZ5242BW	KH2	12	11.40	12.60	20	30	600	1.0	9.1
MMBZ5243BW	KH3	13	12.35	13.65	9.5	13	600	0.5	9.9
MMBZ5245BW	KH5	15	14.25	15.75	8.5	16	600	0.1	11
MMBZ5246BW	KJ1	16	15.20	16.80	7.8	17	600	0.1	12
MMBZ5248BW	KJ3	18	17.10	18.90	7.0	21	600	0.1	14
MMBZ5250BW	KJ5	20	19.00	21.00	6.2	25	600	0.1	15
MMBZ5251BW	KK1	22	20.90	23.10	5.6	29	600	0.1	17
MMBZ5252BW	KK2	24	22.80	25.20	5.2	33	600	0.1	18
MMBZ5254BW	KK4	27	25.65	28.35	5.0	41	600	0.1	21
MMBZ5255BW	KK5	28	26.60	29.40	4.5	44	600	0.1	21
MMBZ5256BW	KM1	30	28.50	31.50	4.2	49	600	0.1	23
MMBZ5257BW	KM2	33	31.35	34.65	3.8	58	700	0.1	25
MMBZ5258BW	KM3	36	34.20	37.80	3.4	70	700	0.1	27
MMBZ5259BW	KM4	39	37.05	40.95	3.2	80	800	0.1	30

Notes: 7. Short duration pulse test used to minimize self-heating effect.  
8.  $f = 1\text{KHz}$ .

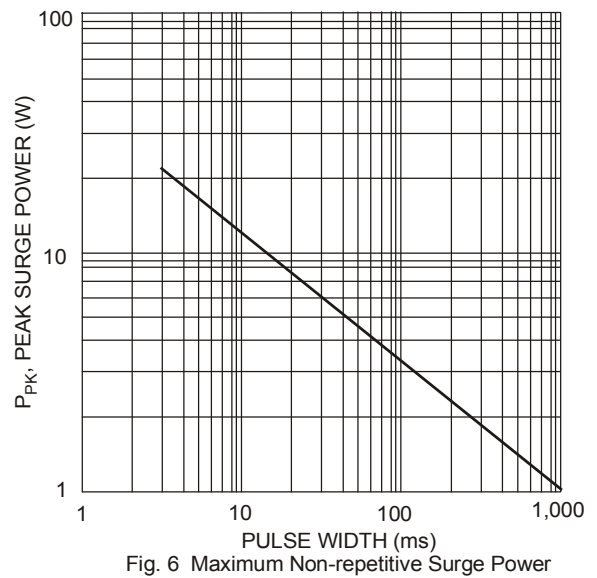
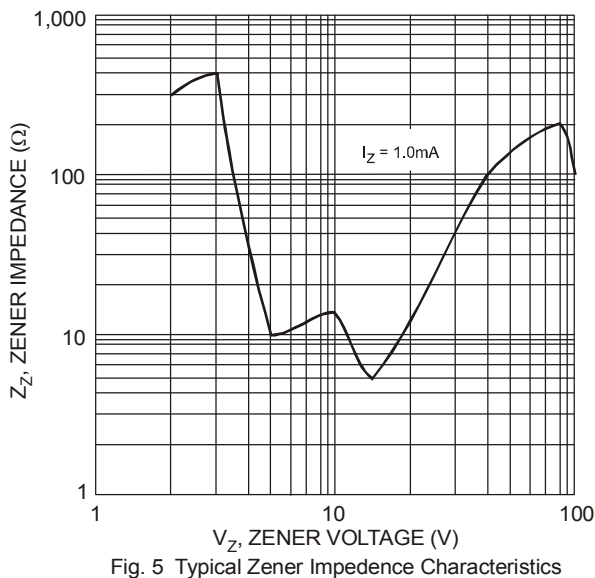
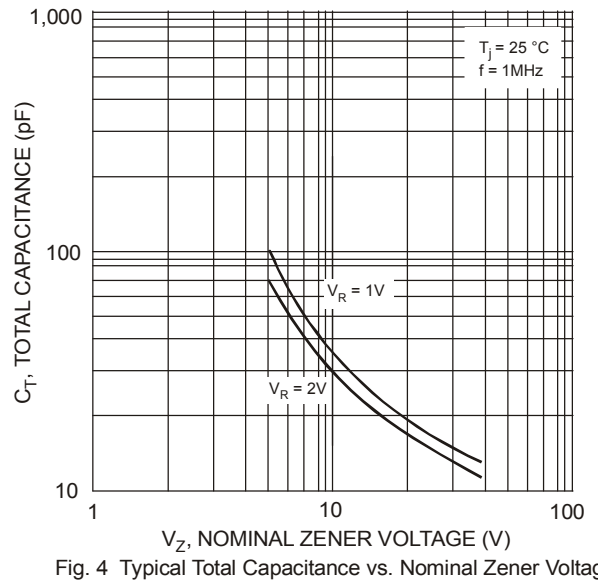
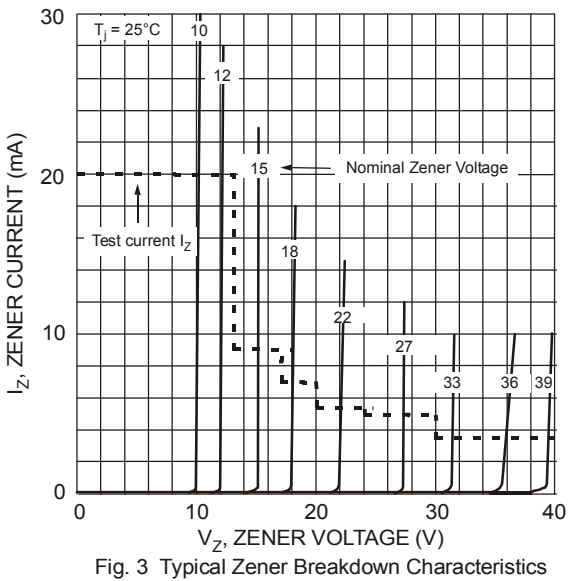
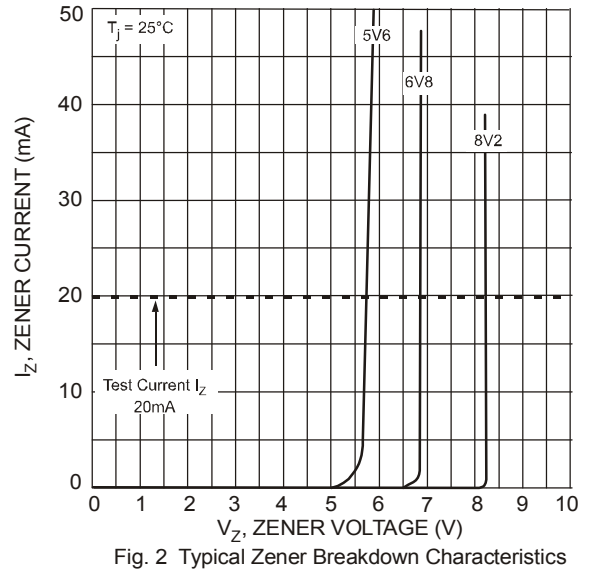
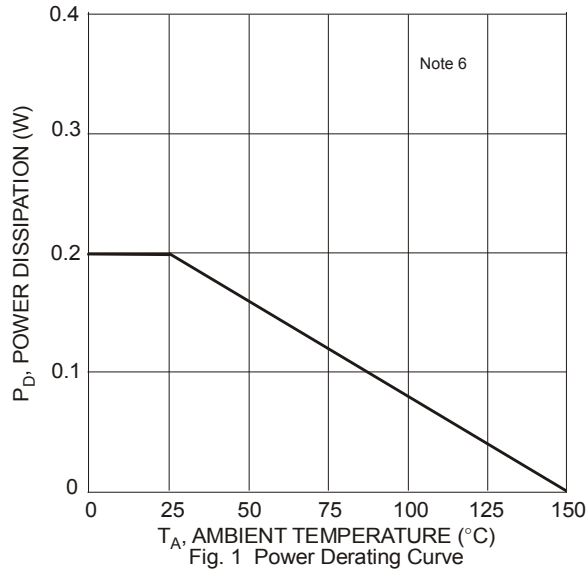

**Package Outline Dimensions**

Please see AP02002 at <http://www.diodes.com/datasheets/ap02002.pdf> for latest version.

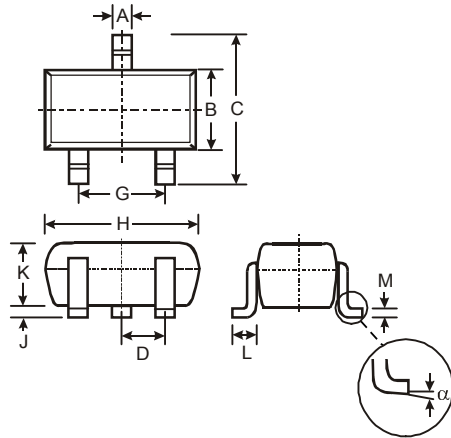

SOT323			
Dim	Min	Max	Typ
A	0.25	0.40	0.30
B	1.15	1.35	1.30
C	2.00	2.20	2.10
D	-	-	0.65
G	1.20	1.40	1.30
H	1.80	2.20	2.15
J	0.0	0.10	0.05
K	0.90	1.00	1.00
L	0.25	0.40	0.30
M	0.10	0.18	0.11
α	0°	8°	-
All Dimensions in mm			

**Suggested Pad Layout**

Please see AP02001 at <http://www.diodes.com/datasheets/ap02001.pdf> for latest version.

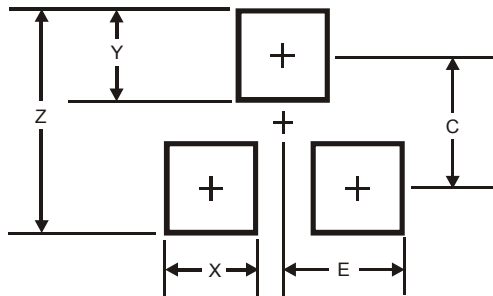

Dimensions	Value (in mm)
Z	2.8
X	0.7
Y	0.9
C	1.9
E	1.0

#### **IMPORTANT NOTICE**

DIODES INCORPORATED MAKES NO WARRANTY OF ANY KIND, EXPRESS OR IMPLIED, WITH REGARDS TO THIS DOCUMENT, INCLUDING, BUT NOT LIMITED TO, THE IMPLIED WARRANTIES OF MERCHANTABILITY AND FITNESS FOR A PARTICULAR PURPOSE (AND THEIR EQUIVALENTS UNDER THE LAWS OF ANY JURISDICTION).

Diodes Incorporated and its subsidiaries reserve the right to make modifications, enhancements, improvements, corrections or other changes without further notice to this document and any product described herein. Diodes Incorporated does not assume any liability arising out of the application or use of this document or any product described herein; neither does Diodes Incorporated convey any license under its patent or trademark rights, nor the rights of others. Any Customer or user of this document or products described herein in such applications shall assume all risks of such use and will agree to hold Diodes Incorporated and all the companies whose products are represented on Diodes Incorporated website, harmless against all damages.

Diodes Incorporated does not warrant or accept any liability whatsoever in respect of any products purchased through unauthorized sales channel. Should Customers purchase or use Diodes Incorporated products for any unintended or unauthorized application, Customers shall indemnify and hold Diodes Incorporated and its representatives harmless against all claims, damages, expenses, and attorney fees arising out of, directly or indirectly, any claim of personal injury or death associated with such unintended or unauthorized application.

Products described herein may be covered by one or more United States, international or foreign patents pending. Product names and markings noted herein may also be covered by one or more United States, international or foreign trademarks.

This document is written in English but may be translated into multiple languages for reference. Only the English version of this document is the final and determinative format released by Diodes Incorporated.

#### **LIFE SUPPORT**

Diodes Incorporated products are specifically not authorized for use as critical components in life support devices or systems without the express written approval of the Chief Executive Officer of Diodes Incorporated. As used herein:

A. Life support devices or systems are devices or systems which:

1. are intended to implant into the body, or
2. support or sustain life and whose failure to perform when properly used in accordance with instructions for use provided in the labeling can be reasonably expected to result in significant injury to the user.

B. A critical component is any component in a life support device or system whose failure to perform can be reasonably expected to cause the failure of the life support device or to affect its safety or effectiveness.

Customers represent that they have all necessary expertise in the safety and regulatory ramifications of their life support devices or systems, and acknowledge and agree that they are solely responsible for all legal, regulatory and safety-related requirements concerning their products and any use of Diodes Incorporated products in such safety-critical, life support devices or systems, notwithstanding any devices- or systems-related information or support that may be provided by Diodes Incorporated. Further, Customers must fully indemnify Diodes Incorporated and its representatives against any damages arising out of the use of Diodes Incorporated products in such safety-critical, life support devices or systems.

Copyright © 2014, Diodes Incorporated

**[www.diodes.com](http://www.diodes.com)**

## X-ON Electronics

Largest Supplier of Electrical and Electronic Components

*Click to view similar products for [Zener Diodes](#) category:*

*Click to view products by [Diodes Zetex](#) manufacturer:*

Other Similar products are found below :

[MMSZ5245BS-7-F](#) [RKZ13B2KG#P1](#) [RKZ5.6B2KJ#R1](#) [EDZTE6113B](#) [EDZTE6116B](#) [EDZTE616.8B](#) [1N747A](#) [1N966B](#) [NTE5116A](#)  
[NTE5121A](#) [NTE5139A](#) [NTE5147A](#) [NTE5152A](#) [NTE5156A](#) [NTE5164A](#) [JANS1N4974US](#) [SMAJ4764A-TP](#) [RKZ5.1BKU#P6](#)  
[3SMAJ5946B-TP](#) [3SMAJ5950B-TP](#) [3SMBJ5920B-TP](#) [3SMBJ5925B-TP](#) [TDZTR24](#) [441774C](#) [MMSZ4678-TP](#) [BZG04-36](#) [BZG05C9V1-](#)  
[HE3-TR](#) [HZM30NBTR-E](#) [UDZTE-175.1B](#) [3SMAJ5945B-TP](#) [3SMAJ5947B-TP](#) [3SMBJ5941B-TP](#) [DL4746A-TP](#) [RKZ18B2KK#R1](#)  
[RKZ10B2KL#R1](#) [RKZ6.8B2KL#R1](#) [RKZ8.2B2KL#R1](#) [DZ2S240M0L](#) [SMAZ27-TP](#) [SMBZ5920B-E3/52](#) [ZMM3.0](#) [RD16UM-T1-A](#) [RD39S-](#)  
[T1-A](#) [RD9.1S-T1-A](#) [RD10S-T1-A](#) [RD20S-T1-A](#) [RD2.2S-T1-A](#) [RD2.7UM-T1-A](#) [HZM24NB1TL-E](#) [HZM2.7NB2TL-E](#)