

DC Film Capacitors MKT Radial Lacquered Type

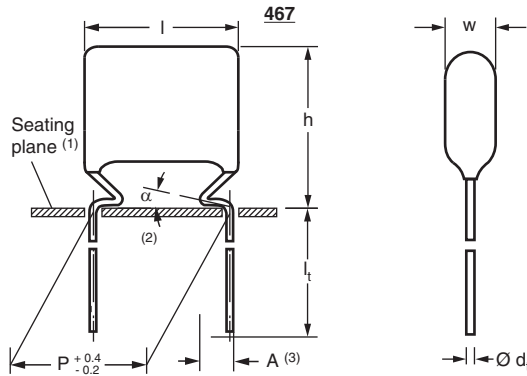

Notes

- (1) Hole \varnothing 1.0 mm for $d_t = 0.6$ mm
- (2) $0 \leq \alpha < 50^\circ$
- (3) $A = 2.0 \text{ mm} \pm 0.5 \text{ mm}$

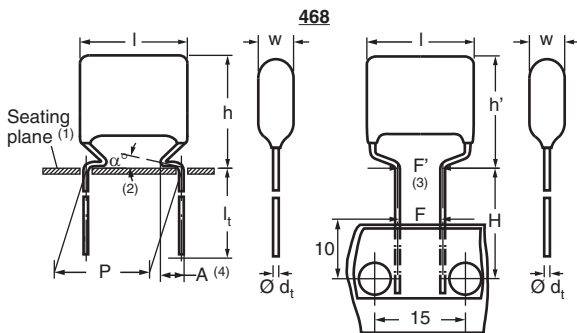

Notes

- (1) Hole \varnothing 1.0 mm for $d_t = 0.8$ mm
- (2) $0 \leq \alpha < 50^\circ$
- (3) $|F - F'| < 0.3 \text{ mm}$
 $F = 7.5 \text{ mm} + 0.6 \text{ mm} / - 0.1 \text{ mm}$
- (4) $A = 2.5 \text{ mm} + 1.4 \text{ mm} / - 0.5 \text{ mm} \pm 0.3 \text{ mm}$

469 Straight Leads

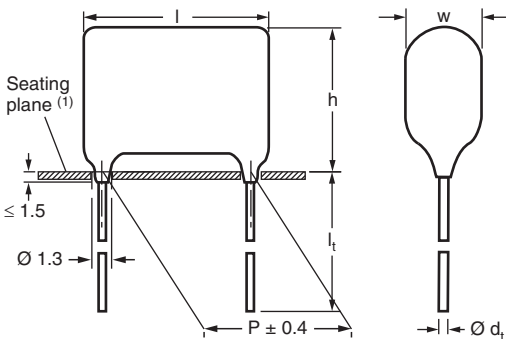

Note

- (1) Hole \varnothing 1.0 for $d_t = 0.6$ mm

CONSTRUCTION

Mono construction

FEATURES

- Available taped and loose in box
- Material categorization:
for definitions of compliance please see www.vishay.com/doc?99912



APPLICATIONS

Blocking and coupling, bypass and energy reservoir.

REFERENCE STANDARDS

IEC 60384-2

MARKING

C-value; tolerance; rated voltage; code for manufacturer; manufacturer's type; manufacturer's logo

DIELECTRIC

Polyester film

ELECTRODES

Metallized

RATED (DC) VOLTAGE

100 V, 250 V, 400 V, 630 V

RATED (AC) VOLTAGE

63 V, 160 V, 220 V, 250 V

ENCAPSULATION

Flame retardant epoxy material (UL-class 94 V-0)

CLIMATIC TESTING CLASS ACCORDING TO IEC 60068-1

55/105/56

RATED TEMPERATURE

85 °C

CAPACITANCE RANGE (E12 SERIES)

467: 0.001 μF to 1.0 μF

468: 0.039 μF to 10.0 μF

469: 0.001 μF to 1.0 μF

CAPACITANCE TOLERANCE

$\pm 10 \%$, $\pm 5 \%$

LEADS

Tinned wire

MAXIMUM APPLICATION TEMPERATURE

105 °C

DETAIL SPECIFICATION

For more detailed data and test requirements contact: dc-film@vishay.com



COMPOSITION OF CATALOG NUMBER: 467

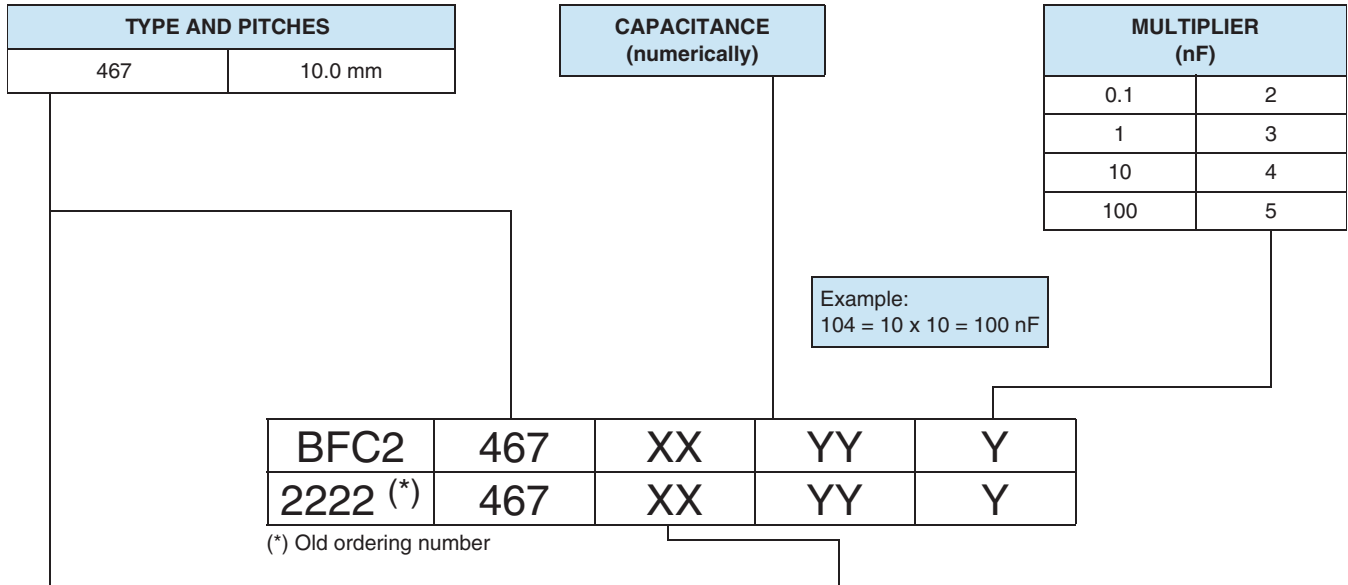

TYPE	PACKAGING	LEAD CONFIGURATION	PREFERRED TYPES				
			C-TOL.	100 V	250 V	400 V	630 V
467	Loose in box	Lead length	± 10 %	04	16	28	40
		3.5 mm + 1.0 mm/- 0.5 mm	± 5 %	05	17	29	41
		Lead length	± 10 %	51	53	55	57
		19.0 mm ± 4.0 mm	± 5 %	52	54	56	58
	Taped on reel (1)	H = 16.0 mm; P ₀ = 12.7 mm	± 10 %	06	18	30	42
		Reel diameter = 500 mm	± 5 %	07	19	31	43

Note

(1) For detailed tape specifications refer to packaging information: www.vishay.com/doc?28139

SPECIFIC REFERENCE DATA: 467

DESCRIPTION	VALUE			
	at 1 kHz	at 10 kHz	at 100 kHz	
Tangent of loss angle:				
C ≤ 0.1 µF	≤ 75 x 10 ⁻⁴	≤ 120 x 10 ⁻⁴	≤ 200 x 10 ⁻⁴	
0.1 µF < C ≤ 0.47 µF	≤ 75 x 10 ⁻⁴	≤ 120 x 10 ⁻⁴	≤ 225 x 10 ⁻⁴	
0.47 µF < C ≤ 1.0 µF	≤ 75 x 10 ⁻⁴	≤ 120 x 10 ⁻⁴	-	
Rated voltage pulse slope (dU/dt) _R at I _{max.} = 12.5 mm	100 V _{DC}	250 V _{DC}	400 V _{DC}	630 V _{DC}
	30 V/µs	120 V/µs	170 V/µs	120 V/µs
R between leads, for C ≤ 0.33 µF				
at 100 V; 1 min	> 15 000 MΩ	> 30 000 MΩ	> 30 000 MΩ	
at 500 V; 1 min				> 30 000 MΩ
R between leads, for C > 0.33 µF				
at 100 V; 1 min	> 5000 s	> 10 000 s	> 10 000 s	
at 500 V; 1 min				> 10 000 s
R between interconnecting leads and casing,				
at 100 V; 1 min	> 30 000 MΩ			
at 500 V; 1 min				
Withstanding (DC) voltage (cut off current 10 mA) (1); rise time ≤ 1000 V/s	160 V; 1 min	400 V; 1 min	640 V; 1 min	1008 V; 1 min
Withstanding (DC) voltage between leads and case	200 V; 1 min	500 V; 1 min	800 V; 1 min	1260 V; 1 min
Maximum application temperature	105 °C			

Note

(1) See "Voltage Proof Test for Metallized Film Capacitors": www.vishay.com/doc?28169



U_{RDC} = 100 V; U_{RAC} = 63 V

C (µF)	DIMENSIONS w _{max.} x h _{max.} x l _{max.} (mm)	MASS (g) (1)	CATALOG NUMBER BFC2 467 XXYYY AND PACKAGING						C-VALUE ..YYY
			LOOSE IN BOX				REEL		
			l _t = 3.5 mm + 1.0 mm / - 0.5 mm		l _t = 19.0 mm ± 4.0 mm		H = 16.0 mm; P ₀ = 12.7 mm		
			C-TOL. = ± 10 %	C-TOL. = ± 5 %	C-TOL. = ± 10 %	C-TOL. = ± 5 %	C-TOL. = ± 10 %	C-TOL. = ± 5 %	
		XX (SPQ)	XX (SPQ)	XX (SPQ)	XX (SPQ)	XX (SPQ)	XX (SPQ)		
Pitch = 10.0 mm ± 0.4 mm; d _t = 0.60 mm ± 0.06 mm									
0.056	4.0 x 14.0 x 12.5	0.37							563
0.068			04...	05...	51...	52...	06...	07...	683
0.082			(2000)	(2000)	(1500)	(1500)	(1500)	(1500)	823
0.10									104
0.12	4.3 x 14.3 x 12.5	0.40	04...	05...	51...	52...	06...	07...	124
			(2000)	(2000)	(1500)	(1500)	(1500)	(1500)	
0.15	4.0 x 14.0 x 12.5	0.37	04...	05...	51...	52...	06...	07...	154
			(2000)	(2000)	(1500)	(1500)	(1500)	(1500)	
0.18	4.2 x 14.2 x 12.5	0.39	04...	05...	51...	52...	06...	07...	184
			(2000)	(2000)	(1500)	(1500)	(1500)	(1500)	
0.22	4.5 x 14.6 x 12.5	0.43	04...	05...	51...	52...	06...	07...	224
			(2000)	(2000)	(1500)	(1500)	(1300)	(1300)	
0.27	4.2 x 14.2 x 12.5	0.39	04...	05...	51...	52...	06...	07...	274
			(2000)	(2000)	(1500)	(1500)	(1500)	(1500)	
0.33	4.6 x 14.6 x 12.5	0.44	04...	05...	51...	52...	06...	07...	334
			(2000)	(2000)	(1500)	(1500)	(1300)	(1300)	
0.39	4.0 x 14.0 x 12.5	0.37	04...	05...	51...	52...	06...	07...	394
			(2000)	(2000)	(1500)	(1500)	(1500)	(1500)	
0.47	4.2 x 14.2 x 12.5	0.39	04...	05...	51...	52...	06...	07...	474
			(2000)	(2000)	(1500)	(1500)	(1500)	(1500)	
0.56	4.6 x 14.6 x 12.5	0.44	04...	05...	51...	52...	06...	07...	564
			(2000)	(2000)	(1500)	(1500)	(1300)	(1300)	
0.68	5.0 x 15.0 x 12.5	0.50	04...	05...	51...	52...	06...	07...	684
			(1500)	(1500)	(1250)	(1250)	(1200)	(1200)	
0.82	5.5 x 15.5 x 12.5	0.60	04...	05...	51...	52...	06...	07...	824
			(1500)	(1500)	(1000)	(1000)	(1100)	(1100)	
1.0	6.0 x 16.0 x 12.5	0.75	04...	05...	51...	52...	06...	07...	105
			(1250)	(1250)	(1000)	(1000)	(1000)	(1000)	

Notes

- SPQ = Standard Packing Quantity
- (1) Net weight for short lead product only



U_{RDC} = 250 V; U_{RAC} = 160 V

C (µF)	DIMENSIONS w _{max.} x h _{max.} x l _{max.} (mm)	MASS (g) ⁽¹⁾	CATALOG NUMBER BFC2 467 XXYYY AND PACKAGING						
			LOOSE IN BOX				REEL		C-VALUE
			l _t = 3.5 mm + 1.0 mm /- 0.5 mm		l _t = 19.0 mm ± 4.0 mm		H = 16.0 mm; P ₀ = 12.7 mm		
			C-TOL. = ± 10 %	C-TOL. = ± 5 %	C-TOL. = ± 10 %	C-TOL. = ± 5 %	C-TOL. = ± 10 %	C-TOL. = ± 5 %	
XX (SPQ)	XX (SPQ)	XX (SPQ)	XX (SPQ)	XX (SPQ)	XX (SPQ)	..YYY			
Pitch = 10.0 mm ± 0.4 mm; d _t = 0.60 mm ± 0.06 mm									
0.027	4.2 x 14.2 x 12.5	0.39	16... (2000)	17... (2000)	53... (1500)	54... (1500)	18... (1500)	19... (1500)	273
0.033	4.6 x 14.6 x 12.5	0.44	16... (2000)	17... (2000)	53... (1500)	54... (1500)	18... (1300)	19... (1300)	333
0.039	4.0 x 14.0 x 12.5	0.37	16... (2000)	17... (2000)	53... (1500)	54... (1500)	18... (1500)	19... (1500)	393
0.047	4.1 x 14.1 x 12.5	0.38	16... (2000)	17... (2000)	53... (1500)	54... (1500)	18... (1500)	19... (1500)	473
0.056	4.0 x 14.0 x 12.5	0.37	16... (2000)	17... (2000)	53... (1500)	54... (1500)	18... (1500)	19... (1500)	563
0.068	4.1 x 14.1 x 12.5	0.38	16... (2000)	17... (2000)	53... (1500)	54... (1500)	18... (1500)	19... (1500)	683
0.082	4.4 x 14.4 x 12.5	0.41	16... (2000)	17... (2000)	53... (1500)	54... (1500)	18... (1500)	19... (1500)	823
0.10	4.0 x 14.0 x 12.5	0.37	16... (2000)	17... (2000)	53... (1500)	54... (1500)	18... (1500)	19... (1500)	104
0.12	4.3 x 14.3 x 12.5	0.40	16... (2000)	17... (2000)	53... (1500)	54... (1500)	18... (1500)	19... (1500)	124
0.15	4.8 x 14.8 x 12.5	0.48	16... (2000)	17... (2000)	53... (1250)	54... (1250)	18... (1300)	19... (1300)	154
0.18	5.2 x 15.2 x 12.5	0.52	16... (1500)	17... (1500)	53... (1000)	54... (1000)	18... (1200)	19... (1200)	184
0.22	5.8 x 15.8 x 12.5	0.67	16... (1500)	17... (1500)	53... (1000)	54... (1000)	18... (1100)	19... (1100)	224

Notes

- SPQ = Standard Packing Quantity
- ⁽¹⁾ Net weight for short lead product only



U_{RDC} = 400 V; U_{RAC} = 220 V

C (µF)	DIMENSIONS w _{max.} x h _{max.} x l _{max.} (mm)	MASS (g) (1)	CATALOG NUMBER BFC2 467 XXYYY AND PACKAGING						C-VALUE ..YYY
			LOOSE IN BOX				REEL		
			l _t = 3.5 mm + 1.0 mm / - 0.5 mm		l _t = 19.0 mm ± 4.0 mm		H = 16.0 mm; P ₀ = 12.7 mm		
			C-TOL. = ± 10 %	C-TOL. = ± 5 %	C-TOL. = ± 10 %	C-TOL. = ± 5 %	C-TOL. = ± 10 %	C-TOL. = ± 5 %	
				XX (SPQ)	XX (SPQ)	XX (SPQ)	XX (SPQ)		
Pitch = 10.0 mm ± 0.4 mm; d_t = 0.60 mm ± 0.06 mm									
0.0010	4.5 x 14.5 x 12.5	0.43	28...	29...	55...	56...	30...	31...	102
0.0012			(2000)	(2000)	(1500)	(1500)	(1300)	(1300)	122
0.0015									152
0.0018									182
0.0022	4.0 x 14.0 x 12.5	0.37	28... (2000)	29... (2000)	55... (1500)	56... (1500)	30... (1500)	31... (1500)	222
0.0027	4.3 x 14.3 x 12.5	0.40	28... (2000)	29... (2000)	55... (1500)	56... (1500)	30... (1500)	31... (1500)	272
0.0033	4.6 x 14.6 x 12.5	0.44	28... (2000)	29... (2000)	55... (1500)	56... (1500)	30... (1300)	31... (1300)	332
0.0039	4.0 x 14.0 x 12.5	0.37	28... (2000)	29... (2000)	55... (1500)	56... (1500)	30... (1500)	31... (1500)	393
0.0047	4.1 x 14.2 x 12.5	0.38	28... (2000)	29... (2000)	55... (1500)	56... (1500)	30... (1500)	31... (1500)	472
0.0056	4.6 x 14.6 x 12.5	0.44	28... (2000)	29... (2000)	55... (1500)	56... (1500)	30... (1300)	31... (1300)	562
0.0068	4.2 x 14.2 x 12.5	0.39	28... (2000)	29... (2000)	55... (1500)	56... (1500)	30... (1500)	31... (1500)	682
0.0082	4.6 x 14.6 x 12.5	0.44	28... (2000)	29... (2000)	55... (1500)	56... (1500)	30... (1300)	31... (1300)	822
0.010	4.1 x 14.1 x 12.5	0.38	28... (2000)	29... (2000)	55... (1500)	56... (1500)	30... (1500)	31... (1500)	103
0.012	4.5 x 14.5 x 12.5	0.43	28... (2000)	29... (2000)	55... (1500)	56... (1500)	30... (1300)	31... (1300)	123
0.015	4.1 x 14.1 x 12.5	0.38	28... (2000)	29... (2000)	55... (1500)	56... (1500)	30... (1500)	31... (1500)	153
0.018	4.5 x 14.5 x 12.5	0.43	28... (2000)	29... (2000)	55... (1500)	56... (1500)	30... (1300)	31... (1300)	183
0.022	4.0 x 14.0 x 12.5	0.37	28... (2000)	29... (2000)	55... (1500)	56... (1500)	30... (1500)	31... (1500)	223
0.027	4.2 x 14.2 x 12.5	0.39	28... (2000)	29... (2000)	55... (1500)	56... (1500)	30... (1500)	31... (1500)	273
0.033	4.6 x 14.7 x 12.5	0.44	28... (2000)	29... (2000)	55... (1500)	56... (1500)	30... (1300)	31... (1300)	333
0.039	5.0 x 14.9 x 12.5	0.50	28... (1500)	29... (1500)	55... (1250)	56... (1250)	30... (1200)	31... (1200)	393
0.047	4.1 x 14.1 x 12.5	0.38	28... (2000)	29... (2000)	55... (1500)	56... (1500)	30... (1500)	31... (1500)	473
0.056	4.4 x 14.4 x 12.5	0.41	28... (2000)	29... (2000)	55... (1500)	56... (1500)	30... (1500)	31... (1500)	563
0.068	4.8 x 14.8 x 12.5	0.48	28... (2000)	29... (2000)	55... (1250)	56... (1250)	30... (1300)	31... (1300)	683
0.082	5.4 x 15.3 x 12.5	0.57	28... (1500)	29... (1500)	55... (1000)	56... (1000)	30... (1200)	31... (1200)	823
0.10	5.7 x 15.7 x 12.5	0.64	28... (1500)	29... (1500)	55... (1000)	56... (1000)	30... (1100)	31... (1100)	104

Notes

- SPQ = Standard Packing Quantity
- (1) Net weight for short lead product only



U_{RDC} = 630 V; U_{RAC} = 250 V

C (μF)	DIMENSIONS w _{max.} x h _{max.} x l _{max.} (mm)	MASS (g) ⁽¹⁾	CATALOG NUMBER BFC2 467 XXYYY AND PACKAGING							C-VALUE
			LOOSE IN BOX				REEL		..YYY	
			l _t = 3.5 mm + 1.0 mm / - 0.5 mm		l _t = 19.0 mm ± 4.0 mm		H = 16.0 mm; P ₀ = 12.7 mm			
			C-TOL. = ± 10 %	C-TOL. = ± 5 %	C-TOL. = ± 10 %	C-TOL. = ± 5 %	C-TOL. = ± 10 %	C-TOL. = ± 5 %		
XX (SPQ)	XX (SPQ)	XX (SPQ)	XX (SPQ)	XX (SPQ)	XX (SPQ)					
Pitch = 10.0 mm ± 0.4 mm; d _t = 0.60 mm ± 0.06 mm										
0.010	4.1 x 14.1 x 12.5	0.38	40... (2000)	41... (2000)	57... (1500)	58... (1500)	42... (1500)	43... (1500)	103	
0.012	4.5 x 14.5 x 12.5	0.43	40... (2000)	41... (2000)	57... (1500)	58... (1500)	42... (1300)	43... (1300)	123	
0.015	4.9 x 14.9 x 12.5	0.49	40... (2000)	41... (2000)	57... (1250)	58... (1250)	42... (1200)	43... (1200)	153	
0.018	5.4 x 15.4 x 12.5	0.57	40... (1500)	41... (1500)	57... (1000)	58... (1000)	42... (1100)	43... (1100)	183	
0.022	4.8 x 14.8 x 12.5	0.48	40... (2000)	41... (2000)	57... (1250)	58... (1250)	42... (1300)	43... (1300)	223	
0.027	5.3 x 15.3 x 12.5	0.55	40... (2000)	41... (2000)	57... (1000)	58... (1000)	42... (1200)	43... (1200)	273	
0.033	5.9 x 15.9 x 12.5	0.70	40... (1500)	41... (1500)	57... (1000)	58... (1000)	42... (1100)	43... (1100)	333	

Notes

- SPQ = Standard Packing Quantity
- ⁽¹⁾ Net weight for short lead product only



COMPOSITION OF CATALOG NUMBER: 468

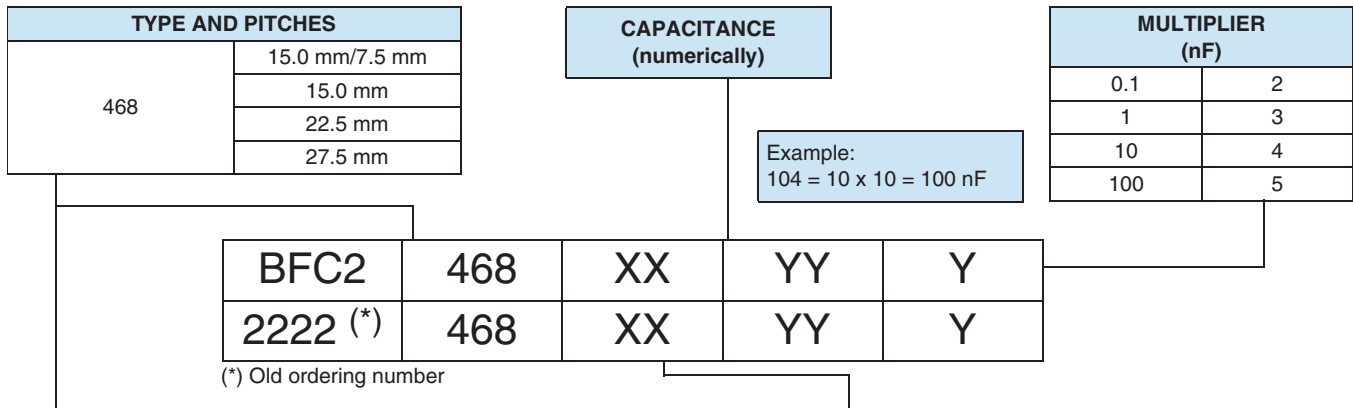

TYPE	PACKAGING	LEAD CONFIGURATION	PREFERRED TYPES				
			C-TOL.	100 V	250 V	400 V	630 V
468	Loose in box	Lead length 3.5 mm + 1.0 mm/- 0.5 mm (Pitch 10 mm and 15 mm)	± 10 %	04	16	28	40
			± 5 %	05	17	29	41
		Long leads: 19.0 mm ± 4.0 mm for lead pitch = 15.0 mm 25.0 mm ± 4.0 mm for lead pitch = 22.5 mm 24.0 mm ± 4.0 mm for lead pitch = 27.5 mm	± 10 %	51	53	55	57
			± 5 %	52	54	56	58
			± 10 %	61	63	65	67
			± 5 %	62	64	66	68
	Taped on reel (1) (bent back)	H = 16.0 mm; P ₀ = 15.0 mm Reel diameter = 500 mm (2)	Dimensions of these code numbers stay between brackets				
			± 10 %	06	18	30	42
	Taped on reel (1)	H = 16.0 mm; P ₀ = 12.7 mm Reel diameter = 500 mm	± 10 %	07	19	31	43
			± 5 %				

Notes

- (1) For detailed tape specifications refer to packaging information: www.vishay.com/doc?28139
- (2) Small reel diameter = 356 mm is available on request

SPECIFIC REFERENCE DATA: 468

DESCRIPTION	VALUE			
	at 1 kHz	at 10 kHz	at 100 kHz	
Tangent of loss angle:				
C ≤ 0.1 μF	≤ 75 x 10 ⁻⁴	≤ 120 x 10 ⁻⁴	≤ 200 x 10 ⁻⁴	
0.1 μF < C ≤ 0.47 μF	≤ 75 x 10 ⁻⁴	≤ 120 x 10 ⁻⁴	≤ 225 x 10 ⁻⁴	
0.47 μF < C ≤ 1.0 μF	≤ 75 x 10 ⁻⁴	≤ 150 x 10 ⁻⁴	-	
Rated voltage pulse slope (dU/dt) _R at	100 V _{DC}	250 V _{DC}	400 V _{DC}	630 V _{DC}
I _{max.} = 12.5 mm	30 V/μs	120 V/μs	170 V/μs	120 V/μs
I _{max.} = 17.5 mm	20 V/μs	45 V/μs	65 V/μs	90 V/μs
I _{max.} = 26.0 mm	10 V/μs	20 V/μs	30 V/μs	35 V/μs
I _{max.} = 30.0 mm		15 V/μs	25 V/μs	30 V/μs
R between leads, for C ≤ 0.33 μF at 100 V; 1 min at 500 V; 1 min	> 15 000 MΩ	> 30 000 MΩ	> 30 000 MΩ	> 30 000 MΩ
R between leads, for C > 0.33 μF at 100 V; 1 min at 500 V; 1 min	> 5000 s	> 10 000 s	> 10 000 s	> 10 000 s
R between interconnecting leads and casing, at 100 V; 1 min at 500 V; 1 min	> 30 000 MΩ	> 30 000 MΩ	> 30 000 MΩ	> 30 000 MΩ
Withstanding (DC) voltage (cut off current 10 mA) (1); rise time ≤ 1000 V/s	160 V; 1 min	400 V; 1 min	640 V; 1 min	1008 V; 1 min
Withstanding (DC) voltage between leads and case	200 V; 1 min	500 V; 1 min	800 V; 1 min	1260 V; 1 min
Maximum application temperature	105 °C			

Note

- (1) See "Voltage Proof Test for Metallized Film Capacitors": www.vishay.com/doc?28169



U_{RDC} = 100 V; U_{RAC} = 63 V

C (μ F)	DIMENSIONS w _{max.} x h (h') _{max.} x l _{max.} (mm)	MASS (g) ⁽¹⁾	CATALOG NUMBER BFC2 468 XXYYY AND PACKAGING									
			LOOSE IN BOX				REEL H = 16.0 mm				C-VALUE	
			C-TOL. = $\pm 10\%$		C-TOL. = $\pm 5\%$		ORIGINAL PITCH		BENT BACK PITCH			
			XX (SPQ)	XX (SPQ)	XX (SPQ)	XX (SPQ)	XX (SPQ)	XX (SPQ)	XX (SPQ)	XX (SPQ)	..YYY	
Pitch = 15.0 mm \pm 0.4 mm; d _t = 0.80 mm \pm 0.08 mm												
			l _t = 3.5 mm + 1.0 mm / - 0.5 mm		l _t = 19.0 mm \pm 4.0 mm		P = 15 mm P ₀ = 12.7 mm		P = 7.5 mm P ₀ = 15.0 mm			
1.2	5.5 x 14.5 (16.0) x 17.5	0.90	04... (2000)	05... (2000)	51... (1250)	52... (1250)	06... (1100)	07... (1100)	61... (900)	62... (900)	125	
1.5	6.0 x 15.0 (16.5) x 17.5	1.00	04... (2000)	05... (2000)	51... (1250)	52... (1250)	06... (1000)	07... (1000)	61... (800)	62... (800)	155	
1.8	6.5 x 15.5 (17.0) x 17.5	1.15	04... (1500)	05... (1500)	51... (1000)	52... (1000)	06... (900)	07... (900)	61... (750)	62... (750)	185	
2.2	7.0 x 16.0 (17.5) x 17.5	1.25	04... (1250)	05... (1250)	51... (1000)	52... (1000)	06... (800)	07... (800)	61... (700)	62... (700)	225	
2.7	8.0 x 17.0 (18.5) x 17.5	1.50	04... (1000)	05... (1000)	51... (1000)	52... (1000)	06... (750)	07... (750)	61... (600)	62... (600)	275	
3.3	8.5 x 17.5 (19.0) x 17.5	1.70	04... (1000)	05... (1000)	51... (1000)	52... (1000)	06... (700)	07... (700)	61... (550)	62... (550)	335	
Pitch = 22.5 mm \pm 0.4 mm; d _t = 0.80 mm \pm 0.08 mm												
			l _t = 3.5 mm \pm 0.5 mm		l _t = 25.0 mm \pm 4.0 mm		P = 22.5 mm P ₀ = 12.7 mm		P = 7.5 mm P ₀ = 15.0 mm			
3.9	6.5 x 18.5 x 26.0	2.1	04... (1000)	05... (1000)	51... (750)	52... (750)					395	
4.7	7.0 x 19.5 x 26.0	2.3	04... (900)	05... (900)	51... (700)	52... (700)					475	
5.6	7.5 x 20.0 x 26.0	2.5	04... (750)	05... (750)	51... (600)	52... (600)					565	
6.8	8.5 x 21.5 x 26.0	3.2	04... (750)	05... (750)	51... (500)	52... (500)					685	
8.2	9.5 x 22.5 x 26.0	3.4	04... (700)	05... (700)	51... (500)	52... (500)					825	
10.0	10.5 x 23.5 x 26.0	3.8	04... (500)	05... (500)	51... (400)	52... (400)					106	

Notes

- SPQ = Standard Packing Quantity
- ⁽¹⁾ Net weight for short lead product only



U_{RDC} = 250 V; U_{RAC} = 160 V

C (μF)	DIMENSIONS w _{max.} x h (h') _{max.} x l _{max.} (mm)	MASS (g) ⁽¹⁾	CATALOG NUMBER BFC2 468 XXYYY AND PACKAGING								C- VALUE ..YYY
			LOOSE IN BOX				REEL H = 16.0 mm				
			ORIGINAL PITCH		BENT BACK PITCH		ORIGINAL PITCH		BENT BACK PITCH		
			C-TOL. = ± 10 %	C-TOL. = ± 5 %	C-TOL. = ± 10 %	C-TOL. = ± 5 %	C-TOL. = ± 10 %	C-TOL. = ± 5 %	C-TOL. = ± 10 %	C-TOL. = ± 5 %	
XX (SPQ)	XX (SPQ)	XX (SPQ)	XX (SPQ)	XX (SPQ)	XX (SPQ)	XX (SPQ)	XX (SPQ)	XX (SPQ)	XX (SPQ)		
Pitch = 15.0 mm ± 0.4 mm; d_t = 0.80 mm ± 0.08 mm											
			l _t = 3.5 mm + 1.0 mm/- 0.5 mm		l _t = 19.0 mm ± 4.0 mm		P = 15 mm P ₀ = 12.7 mm		P = 7.5 mm P ₀ = 15.0 mm		
0.27	5.0 x 14.0 (15.5) x 17.5	0.80	16... (2000)	17... (2000)	53... (1250)	54... (1250)	18... (1200)	19... (1200)	63... (1000)	64... (1000)	274
0.33	5.5 x 14.5 (16.0) x 17.5	0.90	16... (2000)	17... (2000)	53... (1250)	54... (1250)	18... (1100)	19... (1100)	63... (900)	64... (900)	334
0.39	6.0 x 15.0 (16.5) x 17.5	1.00	16... (2000)	17... (2000)	53... (1250)	54... (1250)	18... (1000)	19... (1000)	63... (800)	64... (800)	394
0.47	6.5 x 15.5 (17.0) x 17.5	1.15	16... (1500)	17... (1500)	53... (1000)	54... (1000)	18... (900)	19... (900)	63... (750)	64... (750)	474
0.56	7.5 x 16.5 (18.0) x 17.5	1.30	16... (1250)	17... (1250)	53... (1000)	54... (1000)	18... (800)	19... (800)	63... (650)	64... (650)	564
0.68	8.0 x 17.0 (18.5) x 17.5	1.50	16... (1000)	17... (1000)	53... (1000)	54... (1000)	18... (750)	19... (750)	63... (600)	64... (600)	684
0.82	8.5 x 17.5 (19.0) x 17.5	1.70	16... (1000)	17... (1000)	53... (1000)	54... (1000)	18... (700)	19... (700)	63... (550)	64... (550)	824
1.0	8.0 x 20.0 (21.5) x 17.5	2.10	16... (1000)	17... (1000)	53... (900)	54... (900)	18... (750)	19... (750)	63... (600)	64... (600)	105
Pitch = 22.5 mm ± 0.4 mm; d_t = 0.80 mm ± 0.08 mm											
			l _t = 3.5 mm ± 0.5 mm		l _t = 25.0 mm ± 4.0 mm		P = 22.5 mm P ₀ = 12.7 mm		P = 7.5 mm P ₀ = 15.0 mm		
1.2	7.0 x 19.0 x 26.0	2.3	16... (1000)	17... (1000)	53... (700)	54... (700)					125
1.5	8.0 x 21.0 x 26.0	2.8	16... (750)	17... (750)	53... (500)	54... (500)					155
1.8	9.0 x 22.0 x 26.0	3.3	16... (750)	17... (750)	53... (500)	54... (500)					185
2.2	9.8 x 23.0 x 26.0	3.4	16... (750)	17... (750)	53... (450)	54... (450)					225
2.7	11.0 x 24.0 x 26.0	4.0	16... (500)	17... (500)	53... (400)	54... (400)					275
3.3	12.5 x 25.5 x 26.0	4.5	16... (500)	17... (500)	53... (300)	54... (300)					335
3.9	13.5 x 26.5 x 26.0	5.5	16... (400)	17... (400)	53... (300)	54... (300)					395
4.7	14.9 x 28.0 x 26.0	6.3	16... (250)	17... (250)	53... (250)	54... (250)					475
Pitch = 27.5 mm ± 0.4 mm; d_t = 0.80 mm ± 0.08 mm; A = 2.5 mm + 1.4 mm / - 0.5 mm											
			l _t = 3.5 mm ± 0.5 mm		l _t = 24.0 mm ± 4.0 mm		P = 27.5 mm P ₀ = 12.7 mm		P = 7.5 mm P ₀ = 15.0 mm		
5.6	15.0 x 28.0 x 30.0	7.5	16... (300)	17... (300)	53... (200)	54... (200)					565

Notes

- SPQ = Standard Packing Quantity
- ⁽¹⁾ Net weight for short lead product only



U_{RDC} = 400 V; U_{RAC} = 220 V

C (μ F)	DIMENSIONS $w_{max.} \times h (h')_{max.} \times l_{max.}$ (mm)	MASS (g) ⁽¹⁾	CATALOG NUMBER BFC2 468 XXYYY AND PACKAGING									
			LOOSE IN BOX				REEL H = 16.0 mm				C- VALUE	
			ORIGINAL PITCH		BENT BACK PITCH		..YYY					
			C-TOL. = $\pm 10\%$	C-TOL. = $\pm 5\%$	C-TOL. = $\pm 10\%$	C-TOL. = $\pm 5\%$		C-TOL. = $\pm 10\%$	C-TOL. = $\pm 5\%$			
XX (SPQ)	XX (SPQ)	XX (SPQ)	XX (SPQ)	XX (SPQ)	XX (SPQ)	XX (SPQ)	XX (SPQ)					
Pitch = 15.0 mm \pm 0.4 mm; d_t = 0.80 mm \pm 0.08 mm												
			l _t = 3.5 mm + 1.0 mm / - 0.5 mm		l _t = 19.0 mm \pm 4.0 mm		P = 15 mm P ₀ = 12.7 mm		P = 7.5 mm P ₀ = 15.0 mm			
0.12	5.0 x 14.0 (15.5) x 17.5	0.80	28... (2000)	29... (2000)	55... (1250)	56... (1250)	30... (1200)	31... (1200)	65... (1000)	66... (1000)	124	
0.15	5.8 x 15.0 (16.5) x 17.5	0.95	28... (1750)	29... (1750)	55... (1250)	56... (1250)	30... (1100)	31... (1100)	65... (850)	66... (850)	154	
0.18	6.5 x 15.5 (17.0) x 17.5	1.15	28... (1500)	29... (1500)	55... (1000)	56... (1000)	30... (900)	31... (900)	65... (750)	66... (750)	184	
0.22	7.0 x 16.0 (17.5) x 17.5	1.25	28... (1500)	29... (1500)	55... (1000)	56... (1000)	30... (800)	31... (800)	65... (700)	66... (700)	224	
0.27	7.4 x 16.5 (18.0) x 17.5	1.28	28... (1250)	29... (1250)	55... (1250)	56... (1250)	30... (800)	31... (800)	65... (650)	66... (650)	274	
0.33	8.5 x 17.5 (19.0) x 17.5	1.70	28... (1000)	29... (1000)	55... (1000)	56... (1000)	30... (700)	31... (700)	65... (550)	66... (550)	334	
0.39	7.4 x 19.5 (21.0) x 17.5	2.00	28... (1000)	29... (1000)	55... (1000)	56... (1000)	30... (800)	31... (800)	65... (650)	66... (650)	394	
0.47	8.4 x 20.5 (22.0) x 17.5	2.10	28... (750)	29... (750)	55... (850)	56... (850)	30... (700)	31... (700)	65... (550)	66... (550)	474	
Pitch = 22.5 mm \pm 0.4 mm; d_t = 0.80 mm \pm 0.08 mm												
			l _t = 3.5 mm \pm 0.5 mm		l _t = 25.0 mm \pm 4.0 mm		P = 22.5 mm P ₀ = 12.7 mm		P = 7.5 mm P ₀ = 15.0 mm			
0.56	7.0 x 19.5 x 26.0	2.5	28... (1000)	29... (1000)	55... (650)	56... (650)					564	
0.68	8.0 x 21.0 x 26.0	2.8	28... (750)	29... (750)	55... (500)	56... (500)					684	
0.82	9.0 x 22.0 x 26.0	3.3	28... (750)	29... (750)	55... (500)	56... (500)					824	
1.0	9.9 x 23.0 x 26.0	3.5	28... (750)	29... (750)	55... (450)	56... (450)					105	
1.2	11.0 x 24.0 x 26.0	4.0	28... (500)	29... (500)	55... (400)	56... (400)					125	
Pitch = 27.5 mm \pm 0.4 mm; d_t = 0.80 mm \pm 0.08 mm; A = 2.5 mm + 1.4 mm / - 0.5 mm												
			l _t = 3.5 mm \pm 0.5 mm		l _t = 24.0 mm \pm 4.0 mm		P = 27.5 mm P ₀ = 12.7 mm		P = 7.5 mm P ₀ = 15.0 mm			
1.5	11.5 x 24.5 x 30.0	5.8	28... (450)	29... (450)	55... (300)	56... (300)					155	
1.8	12.5 x 25.5 x 30.0	6.4	28... (350)	29... (350)	55... (250)	56... (250)					185	
2.2	14.0 x 27.0 x 30.0	7.3	28... (300)	29... (300)	55... (200)	56... (200)					225	

Notes

- SPQ = Standard Packing Quantity
- ⁽¹⁾ Net weight for short lead product only



U_{RDC} = 630 V; U_{RAC} = 250 V

C (μF)	DIMENSIONS w _{max.} x h (h') _{max.} x l _{max.} (mm)	MASS (g) ⁽¹⁾	CATALOG NUMBER BFC2 468 XYYYY AND PACKAGING								C- VALUE ..YYY
			LOOSE IN BOX				REEL H = 16.0 mm				
			ORIGINAL PITCH		BENT BACK PITCH		ORIGINAL PITCH		BENT BACK PITCH		
			C-TOL. = ± 10 %	C-TOL. = ± 5 %	C-TOL. = ± 10 %	C-TOL. = ± 5 %	C-TOL. = ± 10 %	C-TOL. = ± 5 %	C-TOL. = ± 10 %	C-TOL. = ± 5 %	
XX (SPQ)	XX (SPQ)	XX (SPQ)	XX (SPQ)	XX (SPQ)	XX (SPQ)	XX (SPQ)	XX (SPQ)	XX (SPQ)	XX (SPQ)		
Pitch = 15.0 mm ± 0.4 mm; d_t = 0.80 mm ± 0.08 mm											
			l _t = 3.5 mm + 1.0 mm/- 0.5 mm		l _t = 19.0 mm ± 4.0 mm		P = 15 mm P ₀ = 12.7 mm		P = 7.5 mm P ₀ = 15.0 mm		
0.039	5.0 x 14.0 (15.5) x 17.5	0.80	40... (2000)	41... (2000)	57... (1250)	58... (1250)	42... (1200)	43... (1200)	67... (1000)	68... (1000)	393
0.047	5.5 x 14.5 (16.0) x 17.5	0.90	40... (2000)	41... (2000)	57... (1250)	58... (1250)	42... (1100)	43... (1100)	67... (900)	68... (900)	473
0.056	5.9 x 15.0 (16.5) x 17.5	0.95	40... (1750)	41... (1750)	57... (1250)	58... (1250)	42... (1000)	43... (1000)	67... (850)	68... (850)	563
0.068	6.5 x 16.0 (17.5) x 17.5	1.15	40... (1500)	41... (1500)	57... (1000)	58... (1000)	42... (800)	43... (800)	67... (750)	68... (750)	683
0.082	7.3 x 16.5 (18.0) x 17.5	1.27	40... (1500)	41... (1500)	57... (1000)	58... (1000)	42... (800)	43... (800)	67... (650)	68... (650)	823
0.10	7.9 x 17.0 (18.5) x 17.5	1.48	40... (1250)	41... (1250)	57... (1000)	58... (1000)	42... (750)	43... (750)	67... (600)	68... (600)	104
0.12	7.5 x 19.5 (21.0) x 17.5	2.00	40... (1250)	41... (1250)	57... (1000)	58... (1000)	42... (800)	43... (800)	67... (650)	68... (650)	124
0.15	8.5 x 20.5 (22.0) x 17.5	2.20	40... (1000)	41... (1000)	57... (850)	58... (850)	42... (700)	43... (700)	67... (550)	68... (550)	154
Pitch = 22.5 mm ± 0.4 mm; d_t = 0.80 mm ± 0.08 mm											
			l _t = 3.5 mm ± 0.5 mm		l _t = 25.0 mm ± 4.0 mm		P = 22.5 mm P ₀ = 12.7 mm		P = 7.5 mm P ₀ = 15.0 mm		
0.18	7.5 x 19.5 x 26.0	2.5	40... (1000)	41... (1000)	57... (650)	58... (650)					184
0.22	8.0 x 21.0 x 26.0	2.8	40... (750)	41... (750)	57... (500)	58... (500)					224
0.27	9.0 x 22.0 x 26.0	3.3	40... (750)	41... (750)	57... (500)	58... (500)					274
0.33	10.0 x 23.0 x 26.0	3.5	40... (700)	41... (700)	57... (450)	58... (450)					334
0.39	11.5 x 24.0 x 26.0	4.2	40... (600)	41... (600)	57... (400)	58... (400)					394
0.47	12.5 x 25.5 x 26.0	4.5	40... (500)	41... (500)	57... (300)	58... (300)					474
0.56	13.5 x 26.6 x 26.0	5.5	40... (450)	41... (450)	57... (300)	58... (300)					564
0.68	15.0 x 28.0 x 26.0	6.5	40... (400)	41... (400)	57... (250)	58... (250)					684
Pitch = 27.5 mm ± 0.4 mm; d_t = 0.80 mm ± 0.08 mm; A = 2.5 mm + 1.4 mm / - 0.5 mm											
			l _t = 3.5 mm ± 0.5 mm		l _t = 24.0 mm ± 4.0 mm		P = 27.5 mm P ₀ = 12.7 mm		P = 7.5 mm P ₀ = 15.0 mm		
0.82	15.0 x 28.0 x 30.0	7.5	40... (300)	41... (300)	57... (200)	58... (200)					-

Notes

- SPQ = Standard Packing Quantity
- ⁽¹⁾ Net weight for short lead product only



COMPOSITION OF CATALOG NUMBER: 469

TYPE AND PITCHES	
469	10.0 mm

CAPACITANCE
(numerically)

MULTIPLIER (nF)	
0.1	2
1	3
10	4
100	5

Example:
104 = 10 x 10 = 100 nF

BFC2	469	XX	YY	Y
2222 (*)	469	XX	YY	Y

(*) Old ordering number

TYPE	PACKAGING	LEAD CONFIGURATION	PREFERRED TYPES				
			C-TOL.	100 V	250 V	400 V	630 V
469	Loose in box	Lead length 4.0 mm + 1.0 mm/- 0.5 mm	± 10 %	25	45	55	65
			± 5 %	26	46	56	66
		Lead length 22.0 mm ± 4.0 mm	± 10 %	21	41	51	61
			± 5 %	22	42	52	62
	Taped on reel (1)	H = 18.5 mm; P ₀ = 12.7 mm Reel diameter = 500 mm	± 10 %	28	48	58	68
			± 5 %	29	49	59	69

Note

(1) For detailed tape specifications refer to packaging information: www.vishay.com/doc?28139

SPECIFIC REFERENCE DATA: 469

DESCRIPTION	VALUE			
	at 1 kHz	at 10 kHz	at 100 kHz	
Tangent of loss angle:				
C ≤ 0.1 μF	≤ 75 x 10 ⁻⁴	≤ 120 x 10 ⁻⁴	≤ 200 x 10 ⁻⁴	
0.1 μF < C ≤ 0.47 μF	≤ 75 x 10 ⁻⁴	≤ 120 x 10 ⁻⁴	≤ 225 x 10 ⁻⁴	
0.47 μF < C ≤ 1.0 μF	≤ 75 x 10 ⁻⁴	≤ 120 x 10 ⁻⁴	-	
Rated voltage pulse slope (dU/dt) _R at I _{max} = 12.5 mm	100 V _{DC}	250 V _{DC}	400 V _{DC}	630 V _{DC}
	30 V/μs	120 V/μs	170 V/μs	120 V/μs
R between leads, for C ≤ 0.33 μF at 100 V; 1 min at 500 V; 1 min	> 15 000 MΩ	> 30 000 MΩ	> 30 000 MΩ	> 30 000 MΩ
R between leads, for C > 0.33 μF at 100 V; 1 min at 500 V; 1 min	> 5000 s	> 10 000 s	> 10 000 s	> 10 000 s
R between interconnecting leads and casing, at 100 V; 1 min at 500 V; 1 min	> 30 000 MΩ	> 30 000 MΩ	> 30 000 MΩ	> 30 000 MΩ
Withstanding (DC) voltage (cut off current 10 mA) (1); rise time ≤ 1000 V/s	160 V; 1 min	400 V; 1 min	640 V; 1 min	1008 V; 1 min
Withstanding (DC) voltage between leads and case	200 V; 1 min	500 V; 1 min	840 V; 1 min	1260 V; 1 min
Maximum application temperature	105 °C			

Note

(1) See "Voltage Proof Test for Metallized Film Capacitors": www.vishay.com/doc?28169



U_{RDC} = 100 V; U_{RAC} = 63 V

C (µF)	DIMENSIONS w _{max.} x h _{max.} x l _{max.} (mm)	MASS (g) (1)	CATALOG NUMBER BFC2 469 XXYYY AND PACKAGING						C-VALUE ..YYY
			LOOSE IN BOX				REEL		
			l _t = 4.0 mm + 1.0 mm / - 0.5 mm		l _t = 22.0 mm ± 4.0 mm		H = 18.5 mm; P ₀ = 12.7 mm		
			C-TOL. = ± 10 %	C-TOL. = ± 5 %	C-TOL. = ± 10 %	C-TOL. = ± 5 %	C-TOL. = ± 10 %	C-TOL. = ± 5 %	
		XX (SPQ)	XX (SPQ)	XX (SPQ)	XX (SPQ)	XX (SPQ)	XX (SPQ)		
Pitch = 10.0 mm ± 0.4 mm; d _t = 0.60 mm ± 0.06 mm									
0.056	4.0 x 11.0 x 12.5	0.35							563
0.068			25...	26...	21...	22...	28...	29...	683
0.082			(2000)	(2000)	(1500)	(1500)	(1500)	(1500)	823
0.10									104
0.12	4.3 x 11.3 x 12.5	0.38	25...	26...	21...	22...	28...	29...	124
			(2000)	(2000)	(1500)	(1500)	(1500)	(1500)	
0.15	3.9 x 10.9 x 12.5	0.34	25...	26...	21...	22...	28...	29...	154
			(2000)	(2000)	(1500)	(1500)	(1500)	(1500)	
0.18	4.2 x 11.2 x 12.5	0.37	25...	26...	21...	22...	28...	29...	184
			(2000)	(2000)	(1500)	(1500)	(1500)	(1500)	
0.22	4.5 x 11.5 x 12.5	0.40	25...	26...	21...	22...	28...	29...	224
			(2000)	(2000)	(1500)	(1500)	(1300)	(1300)	
0.27	4.2 x 11.2 x 12.5	0.37	25...	26...	21...	22...	28...	29...	274
			(2000)	(2000)	(1500)	(1500)	(1500)	(1500)	
0.33	4.6 x 11.6 x 12.5	0.41	25...	26...	21...	22...	28...	29...	334
			(2000)	(2000)	(1500)	(1500)	(1300)	(1300)	
0.39	4.0 x 11.0 x 12.5	0.35	25...	26...	21...	22...	28...	29...	394
			(2000)	(2000)	(1500)	(1500)	(1500)	(1500)	
0.47	4.2 x 11.2 x 12.5	0.37	25...	26...	21...	22...	28...	29...	474
			(2000)	(2000)	(1500)	(1500)	(1500)	(1500)	
0.56	4.6 x 11.6 x 12.5	0.41	25...	26...	21...	22...	28...	29...	564
			(2000)	(2000)	(1500)	(1500)	(1300)	(1300)	
0.68	5.0 x 12.0 x 12.5	0.44	25...	26...	21...	22...	28...	29...	684
			(1500)	(1500)	(1250)	(1250)	(1200)	(1200)	
0.82	5.5 x 12.5 x 12.5	0.47	25...	26...	21...	22...	28...	29...	824
			(1500)	(1500)	(1000)	(1000)	(1100)	(1100)	
1.0	6.0 x 13.0 x 12.5	0.55	25...	26...	21...	22...	28...	29...	105
			(1250)	(1250)	(1000)	(1000)	(1000)	(1000)	

Notes

- SPQ = Standard Packing Quantity
- (1) Net weight for short lead product only



U_{RDC} = 250 V; U_{RAC} = 160 V

C (µF)	DIMENSIONS w _{max.} x h _{max.} x l _{max.} (mm)	MASS (g) ⁽¹⁾	CATALOG NUMBER BFC2 469 XXYYY AND PACKAGING							C-VALUE ..YYY
			LOOSE IN BOX				REEL			
			l _t = 4.0 mm + 1.0 mm / - 0.5 mm		l _t = 22.0 mm ± 4.0 mm		H = 18.5 mm; P ₀ = 12.7 mm			
			C-TOL. = ± 10 %	C-TOL. = ± 5 %	C-TOL. = ± 10 %	C-TOL. = ± 5 %	C-TOL. = ± 10 %	C-TOL. = ± 5 %		
XX (SPQ)	XX (SPQ)	XX (SPQ)	XX (SPQ)	XX (SPQ)	XX (SPQ)	XX (SPQ)	XX (SPQ)			
Pitch = 10.0 mm ± 0.4 mm; d _t = 0.60 mm ± 0.06 mm										
0.027	4.2 x 11.2 x 12.5	0.37	45... (2000)	46... (2000)	41... (1500)	42... (1500)	48... (1500)	49... (1500)	273	
0.033	4.6 x 11.6 x 12.5	0.41	45... (2000)	46... (2000)	41... (1500)	42... (1500)	48... (1300)	49... (1300)	333	
0.039	4.0 x 11.0 x 12.5	0.35	45... (2000)	46... (2000)	41... (1500)	42... (1500)	48... (1500)	49... (1500)	393	
0.047	4.1 x 11.1 x 12.5	0.36	45... (2000)	46... (2000)	41... (1500)	42... (1500)	48... (1500)	49... (1500)	473	
0.056	4.0 x 11.0 x 12.5	0.35	45... (2000)	46... (2000)	41... (1500)	42... (1500)	48... (1500)	49... (1500)	563	
0.068	4.1 x 11.1 x 12.5	0.36	45... (2000)	46... (2000)	41... (1500)	42... (1500)	48... (1500)	49... (1500)	683	
0.082	4.4 x 11.4 x 12.5	0.39	45... (2000)	46... (2000)	41... (1500)	42... (1500)	48... (1500)	49... (1500)	823	
0.10	4.0 x 11.0 x 12.5	0.35	45... (2000)	46... (2000)	41... (1500)	42... (1500)	48... (1500)	49... (1500)	104	
0.12	4.3 x 11.3 x 12.5	0.38	45... (2000)	46... (2000)	41... (1500)	42... (1500)	48... (1500)	49... (1500)	124	
0.15	4.8 x 11.8 x 12.5	0.42	45... (2000)	46... (2000)	41... (1250)	42... (1250)	48... (1300)	49... (1300)	154	
0.18	5.2 x 12.2 x 12.5	0.45	45... (1500)	46... (1500)	41... (1000)	42... (1000)	48... (1200)	49... (1200)	184	
0.22	5.8 x 12.8 x 12.5	0.50	45... (1500)	46... (1500)	41... (1000)	42... (1000)	48... (1100)	49... (1100)	224	

Notes

- SPQ = Standard Packing Quantity
- ⁽¹⁾ Net weight for short lead product only



U_{RDC} = 400 V; U_{RAC} = 220 V

C (µF)	DIMENSIONS w _{max.} x h _{max.} x l _{max.} (mm)	MASS (g) ⁽¹⁾	CATALOG NUMBER BFC2 469 XXYYY AND PACKAGING						C-VALUE ..YYY
			LOOSE IN BOX				REEL		
			l _t = 4.0 mm + 1.0 mm / - 0.5 mm		l _t = 22.0 mm ± 4.0 mm		H = 18.5 mm; P ₀ = 12.7 mm		
			C-TOL. = ± 10 %	C-TOL. = ± 5 %	C-TOL. = ± 10 %	C-TOL. = ± 5 %	C-TOL. = ± 10 %	C-TOL. = ± 5 %	
XX (SPQ)	XX (SPQ)	XX (SPQ)	XX (SPQ)	XX (SPQ)	XX (SPQ)	XX (SPQ)	XX (SPQ)	XX (SPQ)	
Pitch = 10.0 mm ± 0.4 mm; d _t = 0.60 mm ± 0.06 mm									
0.0010	4.5 x 11.5 x 12.5	0.40	55...	56...	51...	52...	58...	59...	102
0.0012			(2000)	(2000)	(1500)	(1500)	(1300)	(1300)	122
0.0015									152
0.0018									182
0.0022	4.0 x 11.0 x 12.5	0.35	55...	56...	51...	52...	58...	59...	222
0.0027	4.3 x 11.3 x 12.5	0.38	55...	56...	51...	52...	58...	59...	272
0.0033	4.6 x 11.6 x 12.5	0.41	55...	56...	51...	52...	58...	59...	332
0.0039	4.0 x 11.0 x 12.5	0.35	55...	56...	51...	52...	58...	59...	392
0.0047	4.1 x 11.1 x 12.5	0.36	55...	56...	51...	52...	58...	59...	472
0.0056	4.6 x 11.6 x 12.5	0.41	55...	56...	51...	52...	58...	59...	562
0.0068	4.2 x 11.2 x 12.5	0.37	55...	56...	51...	52...	58...	59...	682
0.0082	4.6 x 11.6 x 12.5	0.41	55...	56...	51...	52...	58...	59...	822
0.010	4.1 x 11.1 x 12.5	0.36	55...	56...	51...	52...	58...	59...	103
0.012	4.5 x 11.5 x 12.5	0.40	55...	56...	51...	52...	58...	59...	123
0.015	4.1 x 11.1 x 12.5	0.36	55...	56...	51...	52...	58...	59...	153
0.018	4.5 x 11.5 x 12.5	0.40	55...	56...	51...	52...	58...	59...	183
0.022	4.0 x 11.0 x 12.5	0.35	55...	56...	51...	52...	58...	59...	223
0.027	4.2 x 11.2 x 12.5	0.37	55...	56...	51...	52...	58...	59...	273
0.033	4.6 x 11.6 x 12.5	0.41	55...	56...	51...	52...	58...	59...	333
0.039	5.0 x 12.0 x 12.5	0.44	55...	56...	51...	52...	58...	59...	393
0.047	4.1 x 11.1 x 12.5	0.36	55...	56...	51...	52...	58...	59...	473
0.056	4.4 x 11.4 x 12.5	0.39	55...	56...	51...	52...	58...	59...	563
0.068	4.8 x 11.8 x 12.5	0.42	55...	56...	51...	52...	58...	59...	683
0.082	5.4 x 12.4 x 12.5	0.46	55...	56...	51...	52...	58...	59...	823
0.10	5.7 x 12.7 x 12.5	0.48	55...	56...	51...	52...	58...	59...	104

Notes

- SPQ = Standard Packing Quantity
- ⁽¹⁾ Net weight for short lead product only



U_{RDC} = 630 V; U_{RAC} = 250 V

C (µF)	DIMENSIONS w _{max.} x h _{max.} x l _{max.} (mm)	MASS (g) ⁽¹⁾	CATALOG NUMBER BFC2 469 XXYYY AND PACKAGING							C-VALUE ..YYY
			LOOSE IN BOX				REEL			
			l _t = 4.0 mm + 1.0 mm / - 0.5 mm		l _t = 22.0 mm ± 4.0 mm		H = 18.5 mm; P ₀ = 12.7 mm			
			C-TOL. = ± 10 %	C-TOL. = ± 5 %	C-TOL. = ± 10 %	C-TOL. = ± 5 %	C-TOL. = ± 10 %	C-TOL. = ± 5 %		
XX (SPQ)	XX (SPQ)	XX (SPQ)	XX (SPQ)	XX (SPQ)	XX (SPQ)	XX (SPQ)	XX (SPQ)			
Pitch = 10.0 mm ± 0.4 mm; d _t = 0.60 mm ± 0.06 mm										
0.010	4.1 x 11.1 x 12.5	0.36	65... (2000)	66... (2000)	61... (1500)	62... (1500)	68... (1500)	69... (1500)	103	
0.012	4.5 x 11.5 x 12.5	0.40	65... (2000)	66... (2000)	61... (1500)	62... (1500)	68... (1300)	69... (1300)	123	
0.015	4.9 x 11.9 x 12.5	0.43	65... (2000)	66... (2000)	61... (1250)	62... (1250)	68... (1200)	69... (1200)	153	
0.018	5.4 x 12.4 x 12.5	0.46	65... (1500)	66... (1500)	61... (1000)	62... (1000)	68... (1100)	69... (1100)	183	
0.022	4.8 x 11.8 x 12.5	0.42	65... (2000)	66... (2000)	61... (1250)	62... (1250)	68... (1300)	69... (1300)	223	
0.027	5.3 x 12.3 x 12.5	0.46	65... (2000)	66... (2000)	61... (1000)	62... (1000)	68... (1200)	69... (1200)	273	
0.033	5.9 x 12.9 x 12.5	0.52	65... (1500)	66... (1500)	61... (1000)	62... (1000)	68... (1100)	69... (1100)	333	

Notes

- SPQ = Standard Packing Quantity
- ⁽¹⁾ Net weight for short lead product only

MOUNTING

Normal Use

The capacitors are designed for mounting on printed-circuit boards. The capacitors packed in bandoliers are designed for mounting in printed-circuit boards by means of automatic insertion machines.

For detailed tape specifications refer to packaging information: www.vishay.com/doc?28139

Specific Method of Mounting to Withstand Vibration and Shock

In order to withstand vibration and shock tests, it must be ensured that the underside and the kinks are in good contact with the printed-circuit board.

- For pitches ≤ 15 mm capacitors shall be mechanically fixed by the leads
- For larger pitches the capacitors shall be mounted in the same way and the body clamped

Storage Temperature

T_{stg} = -25 °C to +35 °C with RH maximum 75 % without condensation

SOLDERING

For general soldering conditions and wave soldering profile, we refer to the application note: "Soldering Guidelines for Film Capacitors": www.vishay.com/doc?28171

Ratings and Characteristics Reference Conditions

Unless otherwise specified, all electrical values apply to an ambient free air temperature of 23 °C ± 1 °C, an atmospheric pressure of 86 kPa to 106 kPa and a relative humidity of 50 % ± 2 %.

For reference testing, a conditioning period shall be applied over 96 h ± 4 h by heating the products in a circulating air oven at the rated temperature and a relative humidity not exceeding 20 %.



CHARACTERISTICS

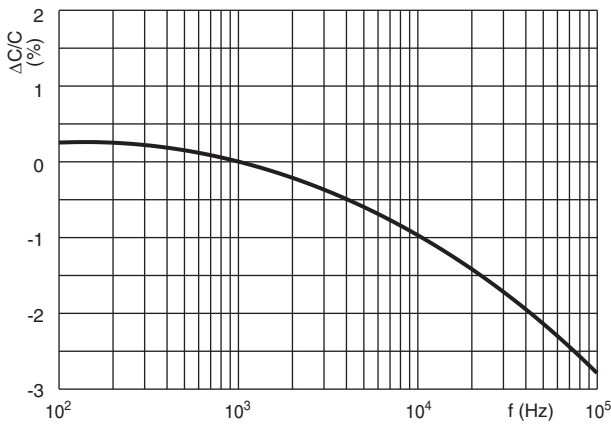

Capacitance as a function of frequency (typical curve)

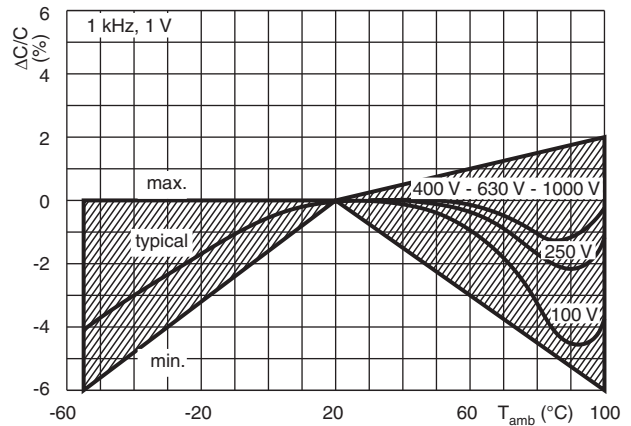

Capacitance as a function of ambient temperature (typical curve)

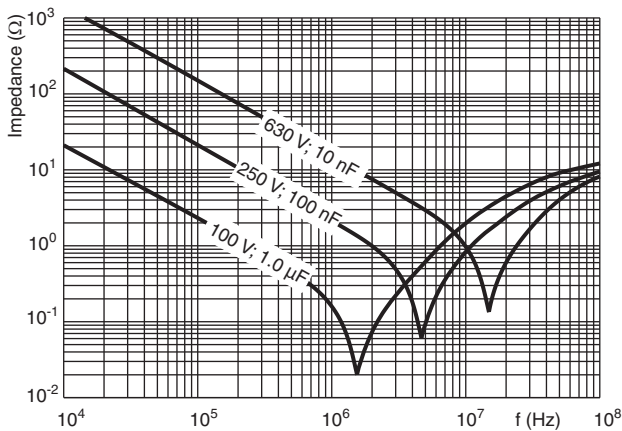

467, 469 - Impedance as a function of frequency (typical curve)

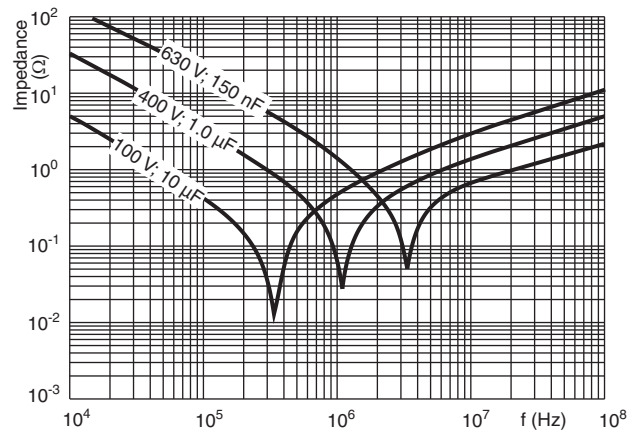

468 - Impedance as a function of frequency (typical curve)

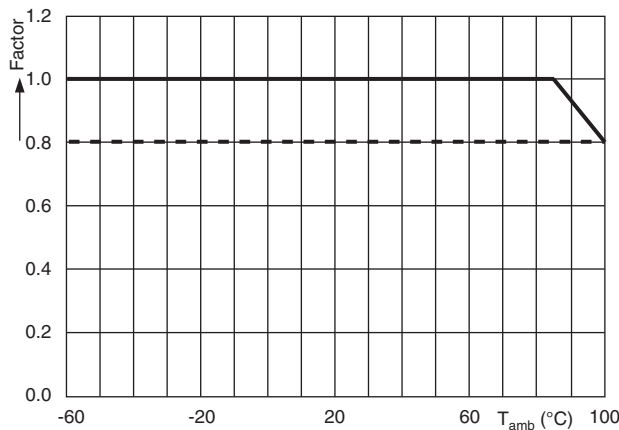

Max. DC and AC voltage as a function of temperature

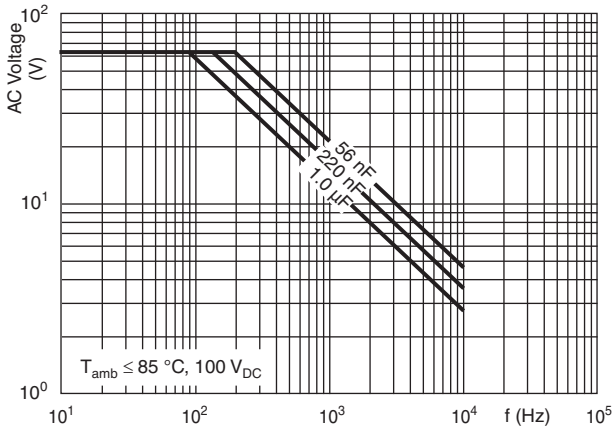

467, 469 - Max. RMS voltage as a function of frequency

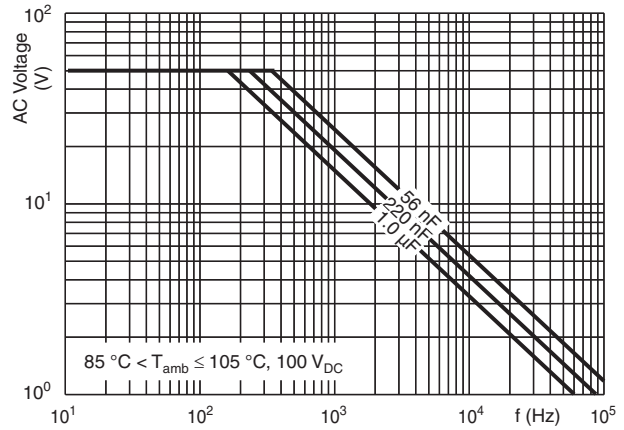

467, 469 - Max. RMS voltage as a function of frequency

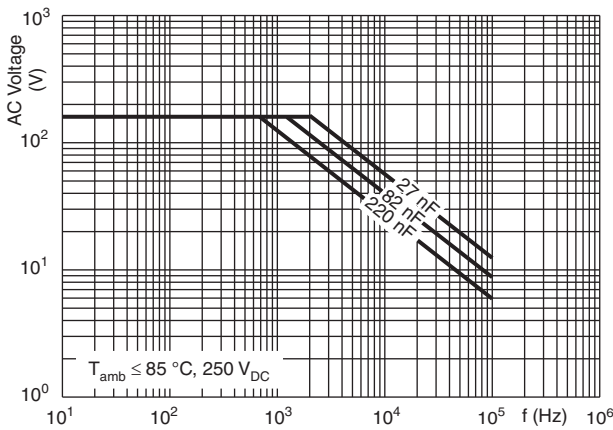

467, 469 - Max. RMS voltage as a function of frequency

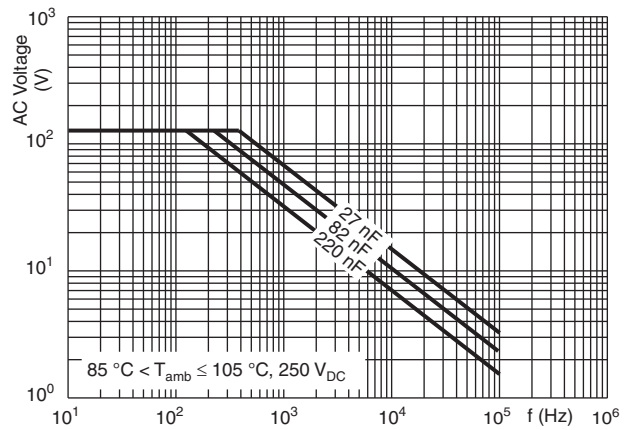

467, 469 - Max. RMS voltage as a function of frequency

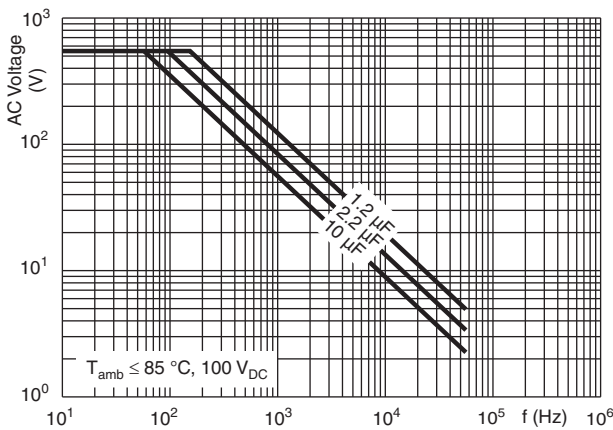

467, 469 - Max. RMS voltage as a function of frequency

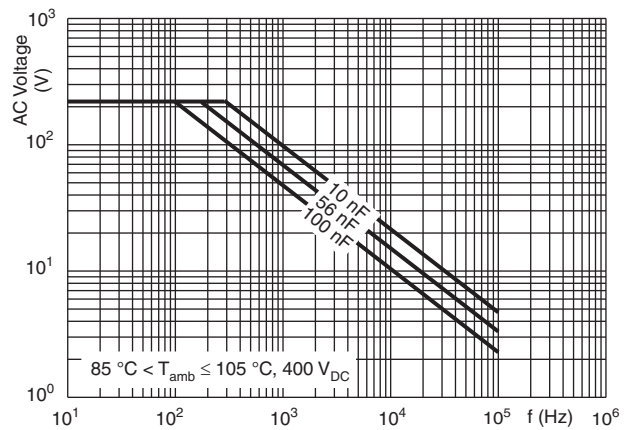

467, 469 - Max. RMS voltage as a function of frequency

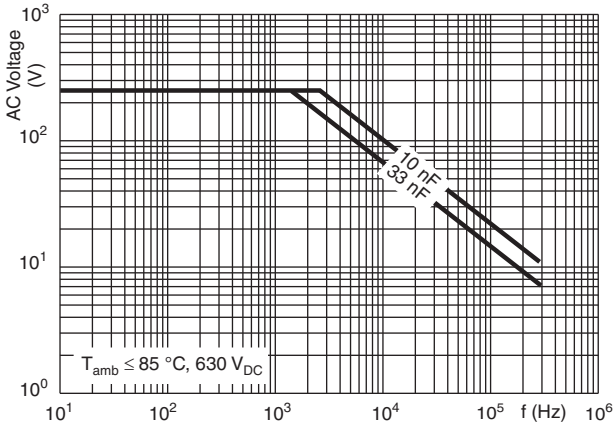

467, 469 - Max. RMS voltage as a function of frequency

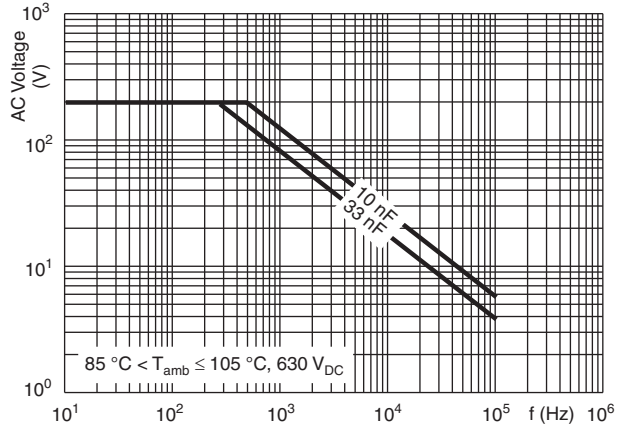

467, 469 - Max. RMS voltage as a function of frequency

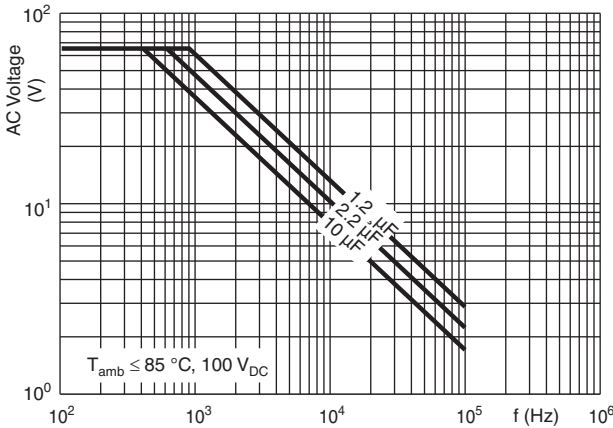

468 - Max. RMS voltage as a function of frequency

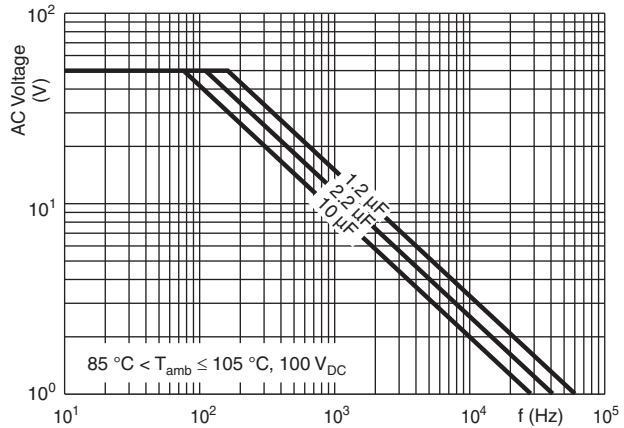

468 - Max. RMS voltage as a function of frequency

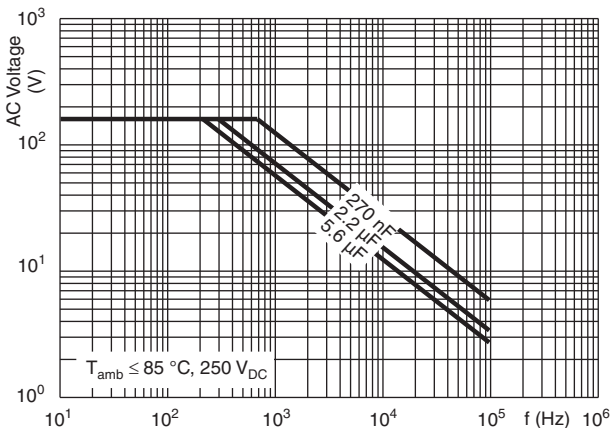

468 - Max. RMS voltage as a function of frequency

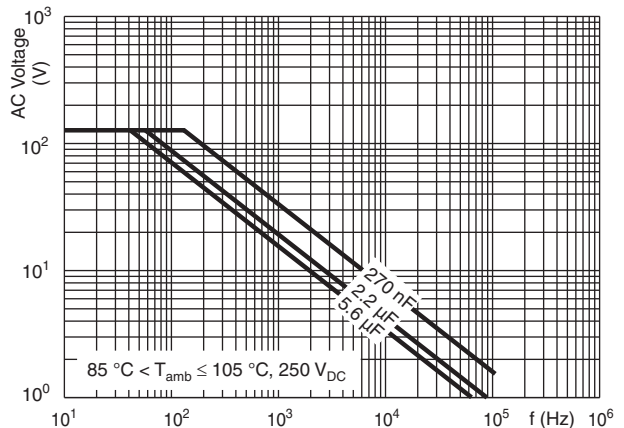

468 - Max. RMS voltage as a function of frequency

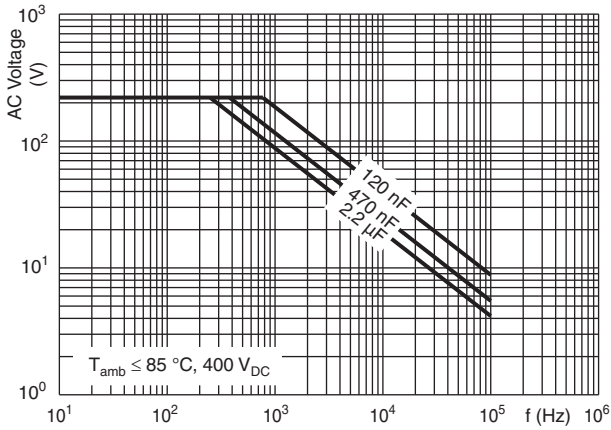

468 - Max. RMS voltage as a function of frequency

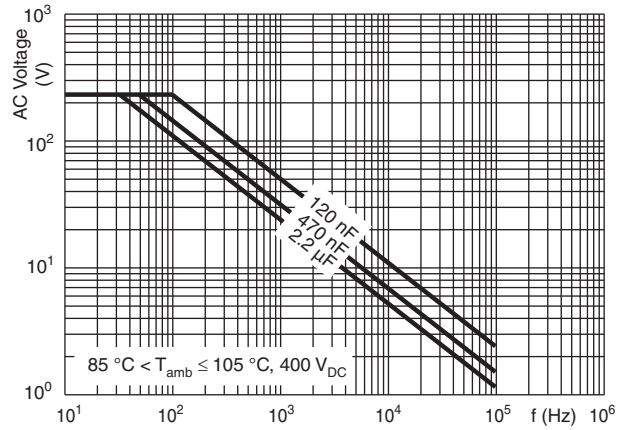

468 - Max. RMS voltage as a function of frequency

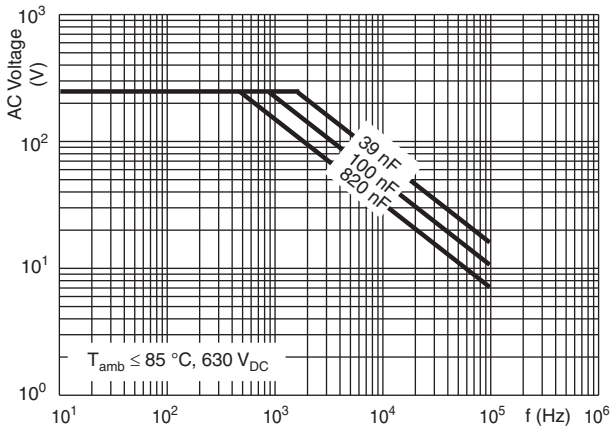

468 - Max. RMS voltage as a function of frequency

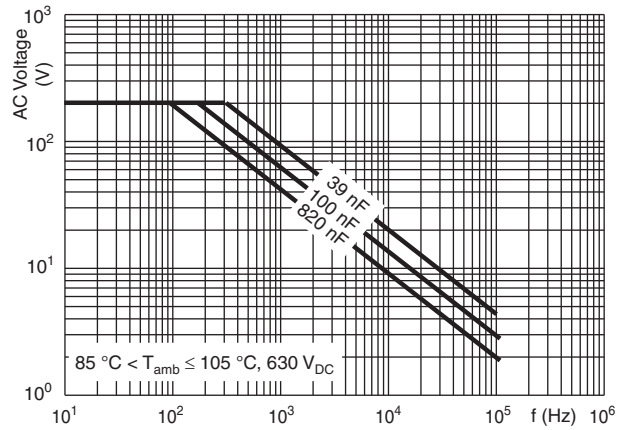

468 - Max. RMS voltage as a function of frequency

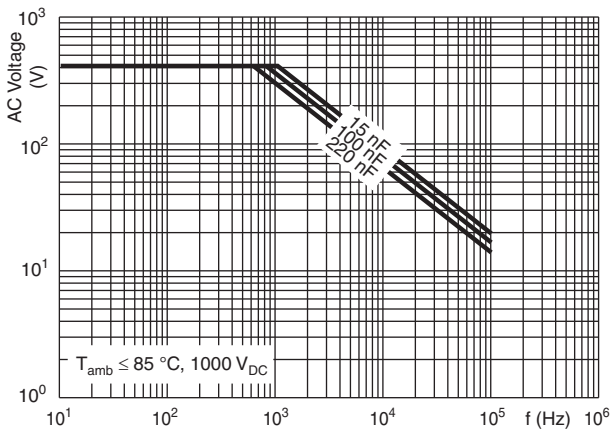

468 - Max. RMS voltage as a function of frequency

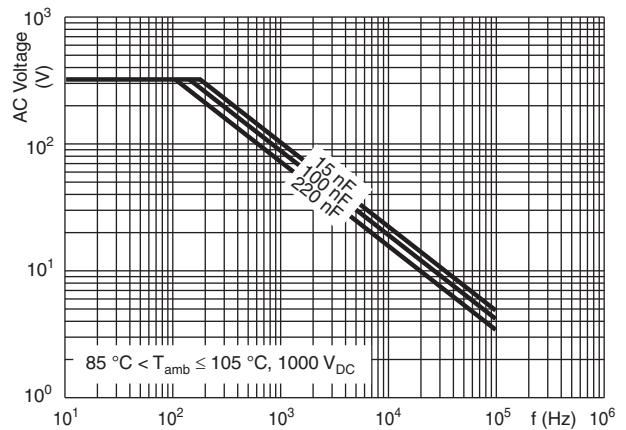

468 - Max. RMS voltage as a function of frequency

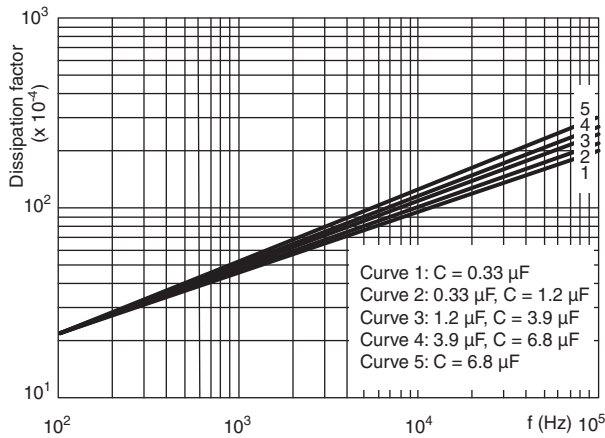

Tangent of loss angle as a function of frequency (typical curve)

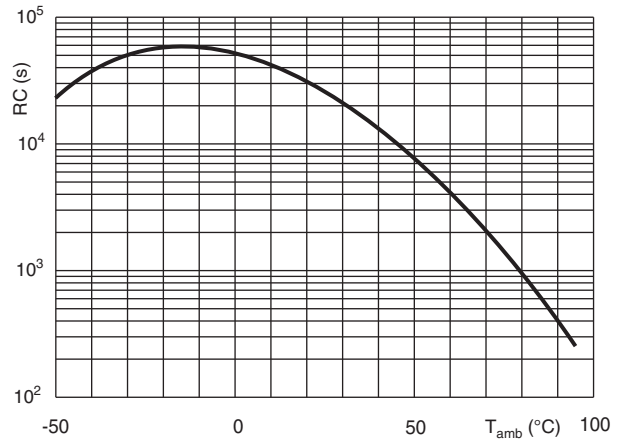

Insulation resistance as a function of the ambient temperature (typical curve)

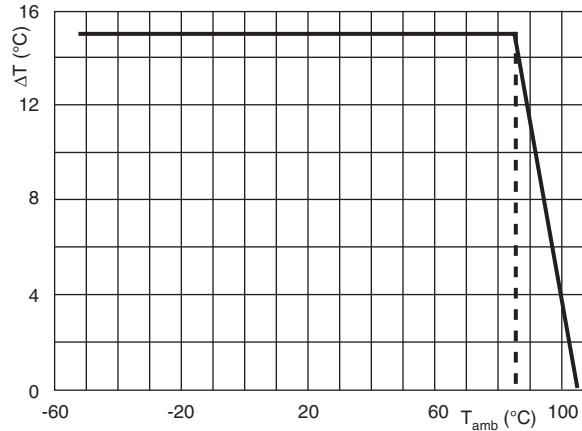

Maximum allowed component temperature rise (ΔT) as a function of the ambient temperature (T_{amb})

HEAT CONDUCTIVITY (G) AS A FUNCTION OF (ORIGINAL) PITCH AND CAPACITOR BODY THICKNESS IN mW/°C

$W_{max.}$ (mm)	HEAT CONDUCTIVITY (mW/°C)			
	PITCH 10 mm	PITCH 15.5 mm	PITCH 22.5 mm	PITCH 27.5 mm
4.0	4.0	5.0	-	-
4.5	4.5	6.0	-	-
5.0	5.0	6.0	12.0	13.0
5.5	6.0	6.5	13.0	15.0
6.0	6.0	6.5	13.0	15.0
6.5	6.5	8.0	15.0	17.0
7.0	-	8.0	15.0	17.0
7.5	-	9.0	17.0	18.0
8.0	-	9.0	17.0	20.0
8.5	-	11.0	18.0	20.0
9.0	-	11.0	18.0	22.0
9.5	-	12.0	20.0	22.0
10.0	-	12.0	20.0	23.0
10.5	-	-	22.0	25.0
11.0	-	-	-	25.0
11.5	-	-	-	27.0

$W_{max.}$ (mm)	HEAT CONDUCTIVITY (mW/°C)			
	PITCH 10 mm	PITCH 15.5 mm	PITCH 22.5 mm	PITCH 27.5 mm
12.0	-	-	-	27.0
12.5	-	-	-	30.0
13.0	-	-	-	30.0
13.5	-	-	-	30.0
14.0	-	-	-	30.0
14.5	-	-	-	33.0
15.0	-	-	-	33.0
15.5	-	-	-	37.0
16.0	-	-	-	37.0

POWER DISSIPATION AND MAXIMUM COMPONENT TEMPERATURE RISE

The power dissipation must be limited in order not to exceed the maximum allowed component temperature rise as a function of the free ambient temperature.

The power dissipation can be calculated according type detail specification "HQN-384-01/101: Technical Information Film Capacitors".

The component temperature rise (ΔT) can be measured (see section "Measuring the component temperature" for more details) or calculated by $\Delta T = P/G$:

- ΔT = component temperature rise (°C)
- P = power dissipation of the component (mW)
- G = heat conductivity of the component (mW/°C)

MEASURING THE COMPONENT TEMPERATURE

A thermocouple must be attached to the capacitor body as in:

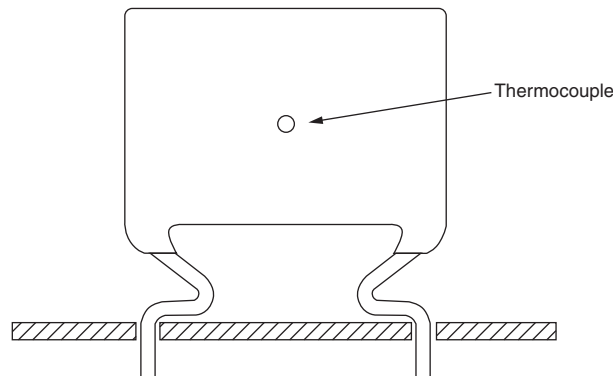

The temperature is measured in unloaded (T_{amb}) and maximum loaded condition (T_C).

The temperature rise is given by $\Delta T = T_C - T_{amb}$.

To avoid radiation or convection, the capacitor should be tested in a wind-free box.

APPLICATION NOTE AND LIMITING CONDITIONS

These capacitors are not suitable for mains applications as across-the-line capacitors without additional protection, as described hereunder. These mains applications are strictly regulated in safety standards and therefore electromagnetic interference suppression capacitors conforming the standards must be used.

For capacitors connected in parallel, normally the proof voltage and possibly the rated voltage must be reduced. For information depending of the capacitance value and the number of parallel connections contact: dc-film@vishay.com

To select the capacitor for a certain application, the following conditions must be checked:

1. The peak voltage (U_P) shall not be greater than the rated DC voltage (U_{RDC})
2. The peak-to-peak voltage (U_{P-P}) shall not be greater than $2\sqrt{2} \times U_{RAC}$ to avoid the ionization inception level

3. The voltage pulse slope (dU/dt) shall not exceed the rated voltage pulse slope in an RC-circuit at rated voltage and without ringing. If the pulse voltage is lower than the rated DC voltage, the rated voltage pulse slope may be multiplied by U_{RDC} and divided by the applied voltage.

For all other pulses following equation must be fulfilled:

$$2 \times \int_0^T \left(\frac{dU}{dt} \right)^2 \times dt < U_{RDC} \times \left(\frac{dU}{dt} \right)_{\text{rated}}$$

T is the pulse duration.

The rated voltage pulse slope is valid for ambient temperatures up to 85 °C. For higher temperatures a derating factor of 3 % per K shall be applied.

4. The maximum component surface temperature rise must be lower than the limits (see graph “Max. allowed component temperature rise”).
5. Since in circuits used at voltages over 280 V peak-to-peak the risk for an intrinsically active flammability after a capacitor breakdown (short circuit) increases, it is recommended that the power to the component is limited to 100 times the values mentioned in the table: “Heat Conductivity”
6. When using these capacitors as across-the-line capacitor in the input filter for mains applications or as series connected with an impedance to the mains the applicant must guarantee that the following conditions are fulfilled in any case (spikes and surge voltages from the mains included).

VOLTAGE CONDITIONS FOR 6 ABOVE

ALLOWED VOLTAGES	$T_{\text{amb}} \leq 85 \text{ } ^\circ\text{C}$	$85 \text{ } ^\circ\text{C} < T_{\text{amb}} \leq 105 \text{ } ^\circ\text{C}$
Maximum continuous RMS voltage	U_{RAC}	$0.8 \times U_{RAC}$
Maximum temperature RMS-overvoltage (< 24 h)	$1.25 \times U_{RAC}$	U_{RAC}
Maximum peak voltage (V_{O-P}) (< 2 s)	$1.6 \times U_{RAC}$	$1.3 \times U_{RAC}$

Example

$C = 330 \text{ nF} - 100 \text{ V}$ used for the voltage signal shown in next drawing.

$U_{P-P} = 80 \text{ V}$; $U_P = 70 \text{ V}$; $T_1 = 0.5 \text{ ms}$; $T_2 = 1 \text{ ms}$

The ambient temperature is 35 °C

Checking conditions:

- The peak voltage $U_P = 70 \text{ V}$ is lower than $100 V_{DC}$
- The peak-to-peak voltage 80 V is lower than $2\sqrt{2} \times 63 V_{AC} = 178 U_{P-P}$
- The voltage pulse slope (dU/dt) = $80 \text{ V}/500 \mu\text{s} = 0.16 \text{ V}/\mu\text{s}$
This is lower than $20 \text{ V}/\mu\text{s}$ (see specific reference data for each version)
- The dissipated power is 60 mW as calculated with fourier terms
The temperature rise for $W_{\text{max.}} = 8.5 \text{ mm}$ and pitch = 15 mm will be $60 \text{ mW}/11 \text{ mW}/^\circ\text{C} = 5.5 \text{ } ^\circ\text{C}$
This is lower than $15 \text{ } ^\circ\text{C}$ temperature rise at $35 \text{ } ^\circ\text{C}$, according figure “Max. allowed component temperature rise”
- Not applicable
- Not applicable

Voltage Signal

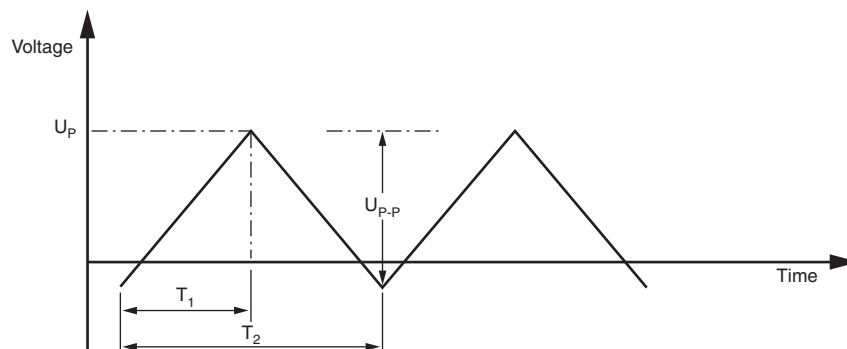



INSPECTION REQUIREMENTS

General Notes

Sub-clause numbers of tests and performance requirements refer to the "Sectional Specification, Publication IEC 60384-2 and Specific Reference Data".

Group C Inspection Requirements

SUB-CLAUSE NUMBER AND TEST	CONDITIONS	PERFORMANCE REQUIREMENTS
SUB-GROUP C1A PART OF SAMPLE OF SUB-GROUP C1		
4.1 Dimensions (detail)		As specified in chapters "General Data" of this specification
4.3.1 Initial measurements	Capacitance Tangent of loss angle: for C ≤ 470 nF at 100 kHz or for C > 470 nF at 10 kHz	
4.3 Robustness of terminations	Tensile: load 10 N; 10 s Bending: load 5 N; 4 x 90°	No visible damage
4.4 Resistance to soldering heat	Method: 1A Solder bath: 280 °C ± 5 °C Duration: 10 s	
4.14 Component solvent resistance	Isopropylalcohol at room temperature Method: 2 Immersion time: 5 min ± 0.5 min Recovery time: min. 1 h, max. 2 h	
4.4.2 Final measurements	Visual examination	No visible damage Legible marking
	Capacitance	ΔC/C ≤ 2 % of the value measured initially
	Tangent of loss angle	Increase of tan δ ≤ 0.005 for: C ≤ 100 nF or ≤ 0.010 for: 100 nF < C ≤ 220 nF or ≤ 0.015 for: 220 nF < C ≤ 470 nF and ≤ 0.003 for: C > 470 nF Compared to values measured in 4.3.1
SUB-GROUP C1B PART OF SAMPLE OF SUB-GROUP C1		
4.6.1 Initial measurements	Capacitance Tangent of loss angle: for C ≤ 470 nF at 100 kHz or for C > 470 nF at 10 kHz	No visible damage
4.6 Rapid change of temperature	θA = -55 °C θB = +100 °C 5 cycles Duration t = 30 min	
4.7 Vibration	Visual examination Mounting: see section "Mounting" of this specification Procedure B4 Frequency range: 10 Hz to 55 Hz Amplitude: 0.75 mm or Acceleration 98 m/s ² (whichever is less severe) Total duration 6 h	No visible damage
4.7.2 Final inspection	Visual examination	No visible damage



SUB-CLAUSE NUMBER AND TEST	CONDITIONS	PERFORMANCE REQUIREMENTS
4.9 Shock	Mounting: see section "Mounting" of this specification Pulse shape: half sine Acceleration: 490 m/s ² Duration of pulse: 11 ms	
4.9.3 Final measurements	Visual examination Capacitance Tangent of loss angle Insulation resistance	No visible damage $ \Delta C/C \leq 3\%$ of the value measured in 4.6.1 Increase of $\tan \delta$ ≤ 0.005 for: $C \leq 100$ nF or ≤ 0.010 for: 100 nF < $C \leq 220$ nF or ≤ 0.015 for: 220 nF < $C \leq 470$ nF and ≤ 0.003 for: $C > 470$ nF Compared to values measured in 4.6.1 As specified in section "Insulation Resistance" of this specification
SUB-GROUP C1 COMBINED SAMPLE OF SPECIMENS OF SUB-GROUPS C1A AND C1B		
4.10 Climatic sequence		
4.10.2 Dry heat	Temperature: +105 °C Duration: 16 h	
4.10.3 Damp heat cyclic Test Db, first cycle		
4.10.4 Cold	Temperature: -55 °C Duration: 2 h	
4.10.6 Damp heat cyclic Test Db, remaining cycles		
4.10.6.2 Final measurements	Voltage proof = U_{RDC} for 1 min within 15 min after removal from test chamber Visual examination Capacitance Tangent of loss angle Insulation resistance	No breakdown or flash-over No visible damage Legible marking $ \Delta C/C \leq 5\%$ of the value measured in 4.4.2 or 4.9.3 Increase of $\tan \delta$ ≤ 0.007 for: $C \leq 100$ nF or ≤ 0.010 for: 100 nF < $C \leq 220$ nF or ≤ 0.015 for: 220 nF < $C \leq 470$ nF and ≤ 0.005 for: $C > 470$ nF Compared to values measured in 4.3.1 or 4.6.1 $\geq 50\%$ of values specified in section "Insulation Resistance" of this specification



SUB-CLAUSe NUMBER AND TEST	CONDITIONS	PERFORMANCE REQUIREMENTS
SUB-GROUP C2		
4.11 Damp heat steady state	56 days, 40 °C, 90 % to 95 % RH	
4.11.1 Initial measurements	Capacitance Tangent of loss angle at 1 kHz	
4.11.3 Final measurements	Voltage proof = U_{RDC} for 1 min within 15 min after removal from test chamber Visual examination Capacitance Tangent of loss angle Insulation resistance	No breakdown or flash-over No visible damage Legible marking $ \Delta C/C \leq 5\%$ of the value measured in 4.11.1. Increase of $\tan \delta \leq 0.005$ Compared to values measured in 4.11.1 $\geq 50\%$ of values specified in section "Insulation Resistance" of this specification
SUB-GROUP C3		
4.12 Endurance	Duration: 2000 h 1.25 x U_{RDC} at 85 °C 1.0 x U_{RDC} at 105 °C	
4.12.1 Initial measurements	Capacitance Tangent of loss angle: for $C \leq 470$ nF at 100 kHz or for $C > 470$ nF at 10 kHz	
4.12.5 Final measurements	Visual examination Capacitance Tangent of loss angle Insulation resistance	No visible damage Legible marking $ \Delta C/C \leq 5\%$ compared to values measured in 4.12.1 Increase of $\tan \delta$ ≤ 0.005 for: $C \leq 100$ nF or ≤ 0.010 for: 100 nF < $C \leq 220$ nF or ≤ 0.015 for: 220 nF < $C \leq 470$ nF and ≤ 0.003 for: $C > 470$ nF Compared to values measured in 4.12.1 $\geq 50\%$ of values specified in section "Insulation Resistance" of this specification
SUB-GROUP C4		
4.13 Charge and discharge	10 000 cycles Charged to U_{RDC} Discharge resistance: $R = \frac{U_R}{C \times 2.5 \times (dU/dt)_R}$	
4.13.1 Initial measurements	Capacitance Tangent of loss angle: for $C \leq 470$ nF at 100 kHz or for $C > 470$ nF at 10 kHz	
4.13.3 Final measurements	Capacitance Tangent of loss angle Insulation resistance	$ \Delta C/C \leq 3\%$ compared to values measured in 4.13.1 Increase of $\tan \delta$ ≤ 0.005 for: $C \leq 100$ nF or ≤ 0.010 for: 100 nF < $C \leq 220$ nF or ≤ 0.015 for: 220 nF < $C \leq 470$ nF and ≤ 0.003 for: $C > 470$ nF Compared to values measured in 4.13.1 $\geq 50\%$ of values specified in section "Insulation Resistance" of this specification



Disclaimer

ALL PRODUCT, PRODUCT SPECIFICATIONS AND DATA ARE SUBJECT TO CHANGE WITHOUT NOTICE TO IMPROVE RELIABILITY, FUNCTION OR DESIGN OR OTHERWISE.

Vishay Intertechnology, Inc., its affiliates, agents, and employees, and all persons acting on its or their behalf (collectively, "Vishay"), disclaim any and all liability for any errors, inaccuracies or incompleteness contained in any datasheet or in any other disclosure relating to any product.

Vishay makes no warranty, representation or guarantee regarding the suitability of the products for any particular purpose or the continuing production of any product. To the maximum extent permitted by applicable law, Vishay disclaims (i) any and all liability arising out of the application or use of any product, (ii) any and all liability, including without limitation special, consequential or incidental damages, and (iii) any and all implied warranties, including warranties of fitness for particular purpose, non-infringement and merchantability.

Statements regarding the suitability of products for certain types of applications are based on Vishay's knowledge of typical requirements that are often placed on Vishay products in generic applications. Such statements are not binding statements about the suitability of products for a particular application. It is the customer's responsibility to validate that a particular product with the properties described in the product specification is suitable for use in a particular application. Parameters provided in datasheets and / or specifications may vary in different applications and performance may vary over time. All operating parameters, including typical parameters, must be validated for each customer application by the customer's technical experts. Product specifications do not expand or otherwise modify Vishay's terms and conditions of purchase, including but not limited to the warranty expressed therein.

Except as expressly indicated in writing, Vishay products are not designed for use in medical, life-saving, or life-sustaining applications or for any other application in which the failure of the Vishay product could result in personal injury or death. Customers using or selling Vishay products not expressly indicated for use in such applications do so at their own risk. Please contact authorized Vishay personnel to obtain written terms and conditions regarding products designed for such applications.

No license, express or implied, by estoppel or otherwise, to any intellectual property rights is granted by this document or by any conduct of Vishay. Product names and markings noted herein may be trademarks of their respective owners.

X-ON Electronics

Largest Supplier of Electrical and Electronic Components

Click to view similar products for [Film Capacitors](#) category:

Click to view products by [Vishay](#) manufacturer:

Other Similar products are found below :

[F339X134748MIP2T0](#) [F450KG153J250ALH0J](#) [750-1018](#) [FKP1-1500160010P15](#) [FKP1R031007D00JYSD](#) [FKP1R031507E00JYSD](#)
[FKP1U024707E00KYSD](#) [82DC4100CK60J](#) [82EC1100DQ50K](#) [PFR5101J100J11L16.5TA18](#) [PME261JB5220KR19T0](#) [A451GK223M040A](#)
[A561ED221M450A](#) [QXJ2E474KTPT](#) [QXL2B333KTPT](#) [R49AN347000A1K](#) [EEC2G505HQA406](#) [B25668A6676A375](#) [B25673A4282E140](#)
[BFC233868148](#) [BFC2370GC222](#) [C3B2AD44400B20K](#) [C4ASWBU3220A3EK](#) [CB027C0473J--](#) [CB177I0184J--](#) [CB182K0184J--](#) [23PW210](#)
[950CQW5H-F](#) [SBDC3470AA10J](#) [SCD105K122A3-22](#) [2N3155](#) [A571EH331M450A](#) [FKP1-2202KV5P15](#) [FKS3-680040010P10](#)
[QXL2E473KTPT](#) [445450-1](#) [B25669A3996J375](#) [46KI322000M1M](#) [46KR415050M1K](#) [4BSNBX4100ZBFJ](#) [MKP383510063JKP2T0](#)
[MKPY2-.02230020P15](#) [MKT 1813-368-015](#) [4055292001](#) [46KN410000N1K](#) [EEC2E106HQA405](#) [EEC2G205HQA402](#) [EEC2G805HQA415](#)
[P409CP224M250AH470](#) [82EC2150DQ50K](#)