

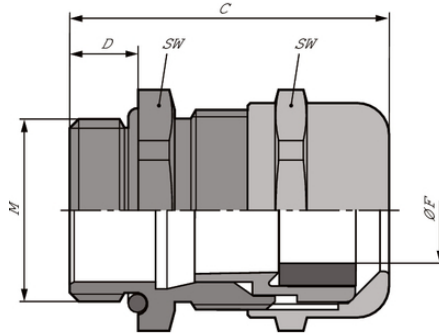







SKINTOP® MS-M-XL

SKINTOP® MS-M-XL, metric nickel-plated brass cable with wide, variable clamping ranges, especially for thick walls



-  Variety of approval certifications
-  Temperature-resistant
-  Acid-resistant
-  Optimum strain relief
-  Mechanical resistance
-  Corrosion-resistant
-  Good chemical resistance

Benefits

Especially for thick walls
 Maximum reliability
 Optimum strain relief
 Wide, variable clamping ranges

Application range

With long connection thread for applications involving a thicker wall.

SKINTOP® MS-M-XL

Norm references / Approvals

UL File Nr. E79903

Product Make-up

Metric connection thread acc. to DIN EN 60423

Basis for technical information DIN IEC 62444

Note

Counter nut to be used: SKINDICHT® SM-M

Refer to SKINTOP® metric accessories for suitable accessories

Technical Data

Classification ETIM 5:	ETIM 5.0 Class-ID: EC000441 ETIM 5.0 Class-Description: Cable screw gland
Classification ETIM 6:	ETIM 6.0 Class-ID: EC000441 ETIM 6.0 Class-Description: Cable screw gland
Caution:	Refer to Appendix T21 for the installation dimensions and torques
Material:	Body: nickel-plated brass Insert: polyamide Sealing: CR O-ring: NBR
Protection rating:	IP 68 - 10 bar IP 69
Temperature range:	dynamic -25°C up to + 100°C Fixed: -40°C to +100°C

Note

Photographs and graphics are not to scale and do not represent detailed images of the respective products.

Prices are net prices without VAT and surcharges. Sale to business customers only.

Article number	Article designation / size	Clamping range ØF (mm)	SW wrench size mm	Overall length, C (mm)
SKINTOP® MS-M-XL				
53112005	M 12 x 1,5	3.5 - 7	16	32
53112015	M 16 x 1,5	4.5 - 10	20	38
53112025	M 20 x 1,5	7 - 13	24	41
53112035	M 25 x 1,5	9 - 17	29	42.5
53112045	M 32 x 1,5	11 - 21	36	51.5
53112055	M 40 x 1,5	19 - 28	45	54.5
53112065	M 50 x 1,5	27 - 35	54	60.5

Last Update (07.04.2018)
 ©2018 Lapp Group - Technical changes reserved
 Product Management www.lappkabel.de
 You can find the current technical data in the corresponding data sheet.
 PN 0456 / 02_03_16

X-ON Electronics

Largest Supplier of Electrical and Electronic Components

Click to view similar products for [Cable Glands, Strain Reliefs & Cord Grips](#) category:

Click to view products by [Lapp Kabel](#) manufacturer:

Other Similar products are found below :

[120-116-1-1-20BP](#) [120-116-1-1-32BE](#) [120-117-40](#) [120-123-14](#) [120-123-16](#) [120-125-16](#) [120-125-16R](#) [120-125-16Y](#) [120-125-24Y](#) [120-125-28](#) [120-125-28R](#) [120-125-32](#) [120-125-32R](#) [120-125-40](#) [120-125-56](#) [120-126-14](#) [120-126-16](#) [120-126-20](#) [120-126-20BL](#) [120-126-20R](#) [120-126-24](#) [120-126-28](#) [120-126-32](#) [120-126-40BL](#) [120-116-1-1-06BP-509](#) [120-116-1-1-06CP](#) [120-116-1-1-16BE](#) [120-116-1-1-28BP](#) [120-123-20](#) [120-123-24](#) [120-123-32](#) [120-125-20](#) [120-125-20Y](#) [120-125-24](#) [120-125-24R](#) [120-125-28Y](#) [120-126-14BL](#) [120-126-16R](#) [120-126-16Y](#) [120-126-24BL](#) [120-126-28BL](#) [120-126-32BL](#) [120-126-40](#) [120-126-48](#) [120-126-48BL](#) [1300980012](#) [1300980105](#) [DBZM-6828](#) [1498](#) [15190-103 R2](#)