

## HS201DR Series Assemblies



- 35 amp AC output @ 40°C
- Single Channel output
- AC or DC input control voltage
- DIN Rail mounted
- UL, CSA, VDE, CE approved SSRs

### PRODUCT SELECTION

Description	35 A	35 A
3-32 VDC Control	HS201DR-D2450	HS201DR-HD6050

### OUTPUT SPECIFICATIONS (1)

Description	HS201DR-D2450	HS201DR-HD6050
Operating Voltage (47-63Hz) [Vrms]	24-280	48-660
Transient Overvoltage [Vpk]	600	1200
Maximum Off-State Leakage Current @ Rated Voltage [mA rms]	10	10
Minimum Off-State dv/dt @ Maximum Rated Voltage [V/μsec] (2)	500	500
Maximum Load Current [Arms]	35	35
Minimum Load Current [Arms]	0.04	0.04
Maximum Surge Current (16.6ms) [A pk]	625	625
Maximum On-State Voltage Drop @ Rated Current [V pk]	1.6	1.7
Maximum I <sup>2</sup> t for Fusing (8.3 msec) [A <sup>2</sup> sec]	1620	1620
Minimum Power Factor (with Maximum Load)	0.5	0.5

### INPUT SPECIFICATIONS (1)

Description	HS201DR-D2450	HS201DR-HA4850
Control Voltage Range	3-32 VDC	3-32 VDC
Minimum Turn-On Voltage	3.0 VDC	3.0 VDC
Minimum Turn-Off Voltage	1.0 VDC	1.0 VDC
Maximum Reverse Voltage	32 VDC	32 VDC
Typical Input Current	3.4 mA @ 5 VDC	2.0 mA (3)
Nominal Input Impedance	1500 Ohms	(3)
Maximum Turn-On Time [msec]	1/2 Cycle	1/2 Cycle
Maximum Turn-Off Time [msec]	1/2 Cycle	1/2 Cycle

### GENERAL SPECIFICATIONS

Description	Parameters
Dielectric Strength, Input/Output/Base (50/60Hz)	4000 Vrms
Minimum Insulation Resistance (@ 500 V DC)	10 <sup>9</sup> Ohms
Maximum Capacitance, Input/Output	8 pF
Ambient Operating Temperature Range	-40 to 80°C
Ambient Storage Temperature Range	-40 to 125°C
Status Indicator Display	None
Weight (typical)	0.97 lb. (440g)
Encapsulation	Themally Conductive Epoxy
Recommended Terminal Screw Torque Range:	6-32 Screws - 10 in/lbs. 8-32 Screws - 20 in/lbs.
Thermal pad installed	Yes

### GENERAL NOTES

- 1) All parameters at 25°C unless otherwise specified.
- 2) Off-State dv/dt test method per EIA/NARM standard RS-443, paragraph 13.11.1
- 3) Input circuitry for DC control version incorporates active current limiter (HD and Dual model only)

**MECHANICAL SPECIFICATIONS**

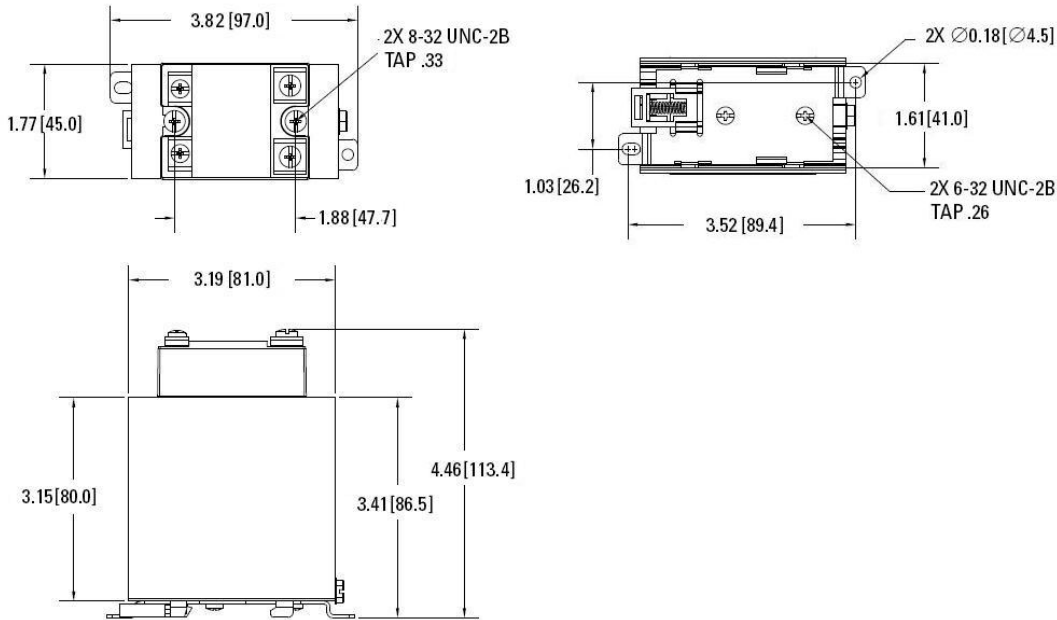

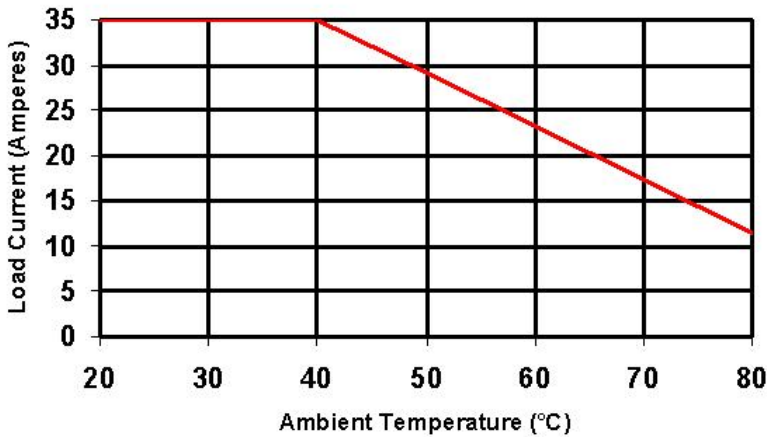

**THERMAL DERATE INFORMATION**

**HS201DR w/50A Single SSR**



**AGENCY APPROVALS**

Designed in accordance with the requirements of IEC 62314  
 Agency approvals are for relay only.

 E116949 (D2450) E116950 (HD6050)
  LR81689 (D2450, HD6050)
  10143 UG (D2450, HD6050)



Rev. 110811

 <b>DANGER / PELIGRO / DANGER /GEFAHR / PERICOLO / PERIGO</b>					
<p><b>HAZARD OF ELECTRIC SHOCK, EXPLOSION, OR ARC FLASH.</b></p> <ul style="list-style-type: none"> <li>• Disconnect all power before installing or working with this equipment.</li> <li>• Verify all connections and replace all covers before turning on power.</li> </ul> <p><b>Failure to follow these instructions will result in death or serious injury.</b></p>	<p><b>RIESGO DE DESCARGA ELECTRICA O EXPLOSION.</b></p> <ul style="list-style-type: none"> <li>• Desconectar todos los suministros de energia a este equipo antes de trabajar con este equipo.</li> <li>• Verificar todas las conexiones y colocar todas las tapas antes de energizar el equipo.</li> </ul> <p><b>EI incumplimiento de estas instrucciones puede provocar la muerte o lesiones serias.</b></p>	<p><b>RISQUE DE DESCARGE ELECTRIQUE OU EXPLOSION</b></p> <ul style="list-style-type: none"> <li>• Eteindre toutes les sources d'énergie de cet appareil avant de travailler dessus de cet appareil</li> <li>• Vérifier tous connections, et remettre tous couverts en olace avant de mettre sous</li> </ul> <p><b>De non-suivi de ces instructions provoquera la mort ou des lésions sérieuses sérieuses.</b></p>	<p><b>GEFAHR EINES ELEKTRISCHE N SCHLAGES ODER EINER EXPLOSION.</b></p> <ul style="list-style-type: none"> <li>• Stellen Sie jeglichen Strom ab, der dieses Gerät versorgt, bevor Sie an dem Gerät Arbeiten durchführen</li> <li>• Vor der Inbetriebnahme alle Anschlüsse überprüfen und alle Gehäuseteile montieren.</li> </ul> <p><b>Unterlassung dieser Anweisungen können zum Tode oder zu schweren Verletzungen führen.</b></p>	<p><b>RISCHIO DI SCOSSA ELETTRICA O DELL'ESPLOSIONE.</b></p> <ul style="list-style-type: none"> <li>• Spenga tutta l'alimentazion e che fornisce questa apparecchiatura prima del lavorare a questa apparecchiatura</li> <li>• Verificare tutti i collegamenti e sostituire tutte le coperture prima della rotazione sull'alimentazione</li> </ul> <p><b>L'omissione di seguire queste istruzioni provocherà la morte o di lesioni serie</b></p>	<p><b>RISCO DE DESCARGA ELÉTRICA OU EXPLOÇÃO</b></p> <ul style="list-style-type: none"> <li>• Desconectar o equipamento de toda a energia antes de instalar ou trabalhar com este equipamento</li> <li>• Verificar todas as conexões e recolocar todas as tampas antes de religar o equipamento</li> </ul> <p><b>O não cumprimento destas instruções pode levar à morte ou lesões sérias.</b></p>

 <b>WARNING / AVERTISSEMENT / WARNUNG /ADVERTENCIA / AVVERTENZA / AVISO</b>		
<p><b>RISK OF MATERIAL DAMAGE AND HOT ENCLOSURE</b></p> <ul style="list-style-type: none"> <li>• The product's side panels may be hot, allow the product to cool before touching.</li> <li>• Follow proper mounting instructions including torque values.</li> <li>• Do not allow liquids or foreign objects to enter this product.</li> </ul> <p><b>Failure to follow these instructions can result in serious injury, or equipment damage.</b></p>	<p><b>RISQUE DE DOMMAGE MATERIEL ET DE SURCHAUFFE DU BOITIER</b></p> <ul style="list-style-type: none"> <li>• Les panneaux latéraux du produit peuvent être chauds. Laissez le produit refroidir avant de le toucher.</li> <li>• Respecter les consignes de montage, et notamment les couples de serrage.</li> <li>• Ne pas laisser pénétrer de liquide ni de corps étrangers à l'intérieur du produit.</li> </ul> <p><b>Le non-respect de cette directive peut entraîner, des lésions corporelles graves ou des dommages matériels.</b></p>	<p><b>GEFAHR VON MATERIALSCHÄDEN UND GEHÄUSEERHITZUNG</b></p> <ul style="list-style-type: none"> <li>• Die Seitenwände können heiß sein. Lassen Sie das Produkt abkühlen, bevor Sie es berühren.</li> <li>• Beachten Sie die Montageanweisungen,</li> <li>• Führen Sie keine Flüssigkeiten oder Fremdkörper in das Produkt ein.</li> </ul> <p><b>Die Nichtbeachtung dieser Anweisung kann Körperverletzung oder Materialschäden zur Folge haben.</b></p>
<p><b>RIESGO DE DAÑOS MATERIALES Y DE SOBRECIENTAMIENTO DE LA UNIDAD</b></p> <ul style="list-style-type: none"> <li>• Los paneles laterales del producto pueden estar calientes. Esperar que el producto se enfríe antes de tocarlo.</li> <li>• Respetar las instrucciones de montaje, y en particular los pares de apretado.</li> <li>• No dejar que penetren líquidos o cuerpos extraños en el producto.</li> </ul> <p><b>Si no se respetan estas precauciones pueden producirse graves lesiones, daños materiales.</b></p>	<p><b>RISCHIO DI DANNI MATERIALI E D'INVOLUCRO CALDO</b></p> <ul style="list-style-type: none"> <li>• I pannelli laterali dell'apparecchio possono scottare; lasciar quindi raffreddare il prodotto prima di toccarlo.</li> <li>• Seguire le istruzioni di montaggio corrette.</li> <li>• Non far entrare liquidi o oggetti estranei in questo apparecchio.</li> </ul> <p><b>La mancata osservanza di questa precauzione può causare gravi rischi per l'incolumità personale o danni alle apparecchiature.</b></p>	<p><b>RISCO DE DANO MATERIAL E DE AQUECIMENTO</b></p> <ul style="list-style-type: none"> <li>• Os painéis laterais do produto podem estar quentes; dê tempo ao produto para arrefecer antes de lhe tocar.</li> <li>• Siga devidamente as instruções de montagem.</li> <li>• Não permita a entrada de líquidos e de objectos estranhos no produto.</li> </ul> <p><b>A não observância destas precauções pode provocar a morte, ferimentos graves ou danos materiais.</b></p>

**ANNEX - ENVIROMENTAL INFORMATION**

The environmental information disclosed in this annex including the EIP Pollution logo are in compliance with People's Republic of China Electronic Industry Standard SJ/T11364 – 2006, Marking for Control of Pollution Caused by Electronic Information Products.

Part Name	Toxic or hazardous Substance and Elements					
	Lead (Pb)	Mercury (Hg)	Cadmium (Cd)	Hexavalent Chromium (Cr (VI))	Polybrominated biphenyls (PBB)	Polybrominated diphenyl ethers (PBDE)
Semiconductor die	X	○	○	○	○	○
Solder	X	○	○	○	○	○

此附件所标示的包括电子信息产品污染图标的环保信息符合中华人民共和国电子行业标准 **SJ/T11364 - 2006**, 电子信息产品污染控制标识要求



部件名称	有毒有害物质或元素					
	铅 (Pb)	汞 (Hg)	镉 (Cd)	六价铬 (Cr (VI))	多溴联苯 (PBB)	多溴二苯醚 (PBDE)
半导体芯片	X	○	○	○	○	○
焊接点	X	○	○	○	○	○

## X-ON Electronics

Largest Supplier of Electrical and Electronic Components

*Click to view similar products for [Heat Sinks](#) category:*

*Click to view products by [Crydom](#) manufacturer:*

Other Similar products are found below :

[581102B00000G](#) [630-35ABT3](#) [656-15ABPE](#) [657-20ABPNE](#) [73452PPBA](#) [7721-13NG](#) [7G0011A](#) [FI306/SE](#) [PF720G](#) [A22-4026](#) [120-1873-007](#) [HAH10L](#) [1542256-2](#) [1542026-1](#) [1542616-1](#) [HS-2506-F1](#) [HS-87M0-F2](#) [218-40CTE3](#) [25-7520](#) [188854F00000G](#) [F-QB-F1](#) [APA501-60-003](#) [253-122ABE-22](#) [PSC22CB](#) [CLP-201](#) [CLP212SG](#) [CLP-7701G](#) [HAA072](#) [HAA083](#) [HAF10L](#) [HAQ10T](#) [D10100-28](#) [TO5-002D](#) [513101B02500G](#) [BDN183CBA01](#) [531202B0000](#) [HS-56M0-C1](#) [3-21053-4](#) [TX0506-1B](#) [TX1806B](#) [336614B-00000](#) [V2004X](#) [LAE66A3CB](#) [WA-DT2-101E](#) [511-3U](#) [017177](#) [530510B00000G](#) [6110BG](#) [73381PPBA](#) [73403PPBA](#)