

Features

Printed circuit mount, general purpose
2, 3 & 4 Pole relays

- 55.12 - 2 Pole 10 A
- 55.13 - 3 Pole 10 A
- 55.14 - 4 Pole 7 A

- AC coils & DC coils
- Cadmium Free contacts (preferred version)
- Contact material options
- RT III (wash tight) option available

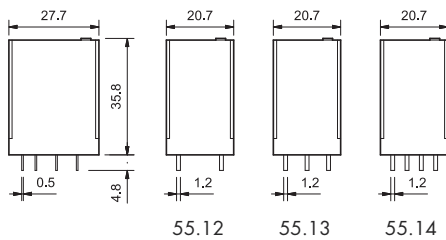

FOR UL HORSEPOWER AND PILOT DUTY RATINGS
SEE "General technical information" page V

Contact specification

Contact configuration	2 CO (DPDT)	3 CO (3PDT)	4 CO (4PDT)
Rated current/Maximum peak current A	10/20	10/20	7/15
Rated voltage/Maximum switching voltage V AC	250/400	250/400	250/250
Rated load AC1 VA	2,500	2,500	1,750
Rated load AC15 (230 V AC) VA	500	500	350
Single phase motor rating (230 V AC) kW	0.37	0.37	0.125
Breaking capacity DC1: 30/110/220V A	10/0.25/0.12	10/0.25/0.12	7/0.25/0.12
Minimum switching load mW (V/mA)	300 (5/5)	300 (5/5)	300 (5/5)
Standard contact material	AgNi	AgNi	AgNi

Coil specification

Nominal voltage (U _N)	V AC (50/60 Hz)	6 - 12 - 24 - 48 - 60 - 110 - 120 - 230 - 240		
	V DC	6 - 12 - 24 - 48 - 60 - 110 - 125 - 220		
Rated power AC/DC VA (50 Hz)/W		1.5/1	1.5/1	1.5/1
Operating range	AC	(0.8...1.1)U _N		
	DC	(0.8...1.1)U _N		
Holding voltage	AC/DC	0.8 U _N /0.5 U _N		
Must drop-out voltage	AC/DC	0.2 U _N /0.1 U _N		

Technical data

Mechanical life AC/DC	cycles	20 · 10 ⁶ /50 · 10 ⁶	20 · 10 ⁶ /50 · 10 ⁶	20 · 10 ⁶ /50 · 10 ⁶
Electrical life at rated load AC1	cycles	200 · 10 ³	200 · 10 ³	150 · 10 ³
Operate/release time	ms	9/3	9/3	9/3
Insulation between coil and contacts (1.2/50 μs)	kV	4	4	4
Dielectric strength between open contacts	V AC	1,000	1,000	1,000
Ambient temperature range	°C	-40...+85	-40...+85	-40...+85
Environmental protection		RT I	RT I	RT I

Approvals (according to type)



55.12



- 2 pole, 10 A
- PCB mount

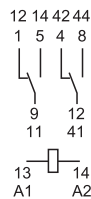

Copper side view

55.13



- 3 pole, 10 A
- PCB mount

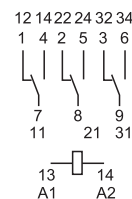

Copper side view

55.14



- 4 pole, 7 A
- PCB mount

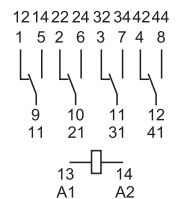

Copper side view

Features

Plug-in mount, general purpose
2, 3 & 4 Pole relays

- 55.32 - 2 Pole 10 A
- 55.33 - 3 Pole 10 A
- 55.34 - 4 Pole 7 A

- Lockable test button and mechanical flag indicator as standard on 2 & 4 pole types
- AC coils & DC coils
- UL Listing (certain relay/socket combinations)
- Cadmium Free contacts (preferred version)
- Contact material options
- 94 series sockets
- Coil EMC suppression
- Timer accessories 86 series

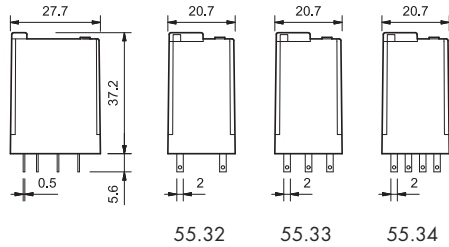

55.32	55.33	55.34
<ul style="list-style-type: none"> • 2 pole, 10 A • Plug-in 94 series sockets 	<ul style="list-style-type: none"> • 3 pole, 10 A • Plug-in 94 series sockets 	<ul style="list-style-type: none"> • 4 pole, 7 A • Plug-in 94 series sockets

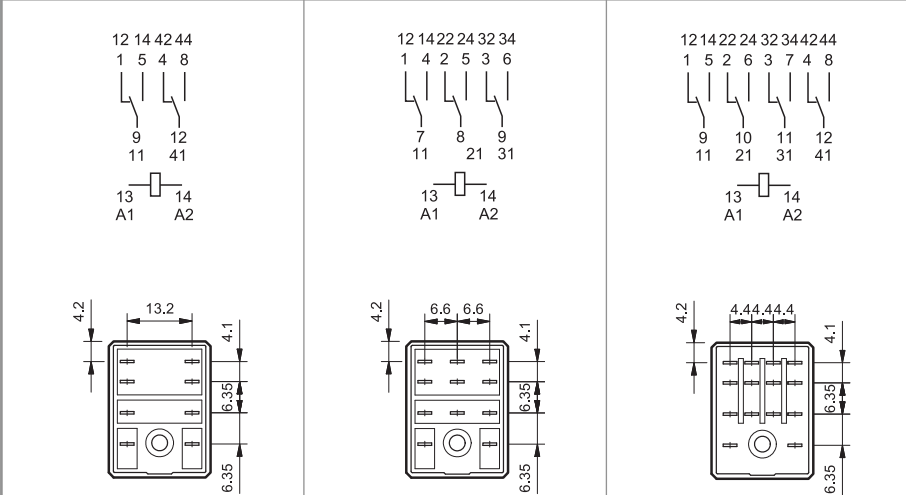

FOR UL HORSEPOWER AND PILOT DUTY RATINGS
SEE "General technical information" page V

Contact specification		55.32	55.33	55.34
Contact configuration		2 CO (DPDT)	3 CO (3PDT)	4 CO (4PDT)
Rated current/Maximum peak current	A	10/20	10/20	7/15
Rated voltage/Maximum switching voltage	V AC	250/400	250/400	250/250
Rated load AC1	VA	2,500	2,500	1,750
Rated load AC15 (230 V AC)	VA	500	500	350
Single phase motor rating (230 V AC)	kW	0.37	0.37	0.125
Breaking capacity DC1: 30/110/220 V	A	10/0.25/0.12	10/0.25/0.12	7/0.25/0.12
Minimum switching load	mW (V/mA)	300 (5/5)	300 (5/5)	300 (5/5)
Standard contact material		AgNi	AgNi	AgNi
Coil specification		55.32	55.33	55.34
Nominal voltage (U _N)	V AC (50/60 Hz)	6 - 12 - 24 - 48 - 60 - 110 - 120 - 230 - 240		
	V DC	6 - 12 - 24 - 48 - 60 - 110 - 125 - 220		
Rated power AC/DC	VA (50 Hz)/W	1.5/1	1.5/1	1.5/1
Operating range	AC	(0.8...1.1)U _N	(0.8...1.1)U _N	(0.8...1.1)U _N
	DC	(0.8...1.1)U _N	(0.8...1.1)U _N	(0.8...1.1)U _N
Holding voltage	AC/DC	0.8 U _N /0.5 U _N	0.8 U _N /0.5 U _N	0.8 U _N /0.5 U _N
Must drop-out voltage	AC/DC	0.2 U _N /0.1 U _N	0.2 U _N /0.1 U _N	0.2 U _N /0.1 U _N
Technical data		55.32	55.33	55.34
Mechanical life AC/DC	cycles	20 · 10 ⁶ /50 · 10 ⁶	20 · 10 ⁶ /50 · 10 ⁶	20 · 10 ⁶ /50 · 10 ⁶
Electrical life at rated load AC1	cycles	200 · 10 ³	200 · 10 ³	150 · 10 ³
Operate/release time	ms	9/3	9/3	9/3
Insulation between coil and contacts (1.2/50 μs)	kV	4	4	4
Dielectric strength between open contacts	V AC	1,000	1,000	1,000
Ambient temperature range	°C	-40...+85	-40...+85	-40...+85
Environmental protection		RT I	RT I	RT I

Approvals (according to type)



Ordering information

Example: 55 series plug-in relay, 4 CO (4PDT), 12 V DC coil, lockable test button and mechanical indicator.

	5	5	.	3	.	4	.	9	.	0	1	2	.	0	A	0	B	0	C	4	D	0
--	----------	----------	----------	----------	----------	----------	----------	----------	----------	----------	----------	----------	----------	----------	----------	----------	----------	----------	----------	----------	----------	----------

Series _____

Type _____

1 = PCB
3 = Plug-in

No. of poles _____

2 = 2 pole, 10 A
3 = 3 pole, 10 A
4 = 4 pole, 7 A

Coil version _____

8 = AC (50/60 Hz)
9 = DC

Coil voltage _____

See coil specifications

A: Contact material

0 = Standard AgNi
2 = AgCdO
5 = AgNi + Au (5 µm)

B: Contact circuit

0 = CO (nPDT)

D: Special versions

0 = Standard
1 = Wash tight (RT III)
for 55.12, 55.13 and 55.14 only

C: Options

0 = None
1 = Lockable test button
2 = Mechanical indicator
3 = LED (AC)
4 = Lockable test button+mechanical indicator
5 = Lockable test button + LED (AC)
54 = Lockable test button + LED (AC)
+ mechanical indicator
6* = Double LED (DC non-polarized)
7* = Lockable test button + double LED
(DC non-polarized)
74* = Lockable test button + double LED
(DC non-polarized)
+ mechanical indicator
8* = LED + diode
(DC, polarity positive to pin A1/13)
9* = Lockable test button + LED + diode (DC,
polarity positive to pin A1/13)
94* = Lockable test button + LED + diode (DC,
polarity positive to pin A1/13)
+ mechanical indicator

* Option not available for the 220 V DC version.

Selecting features and options: only combinations in the same row are possible.
Preferred selections for best availability are shown in **bold**.

Type	Coil version	A	B	C	D
55.32/34	AC-DC	0 - 2 - 5	0	0	0
	AC	0 - 2 - 5	0	2 - 3 - 4 - 5	0
	AC	0 - 2 - 5	0	54	/
	DC	0 - 2 - 5	0	2 - 4 - 6 - 7 - 8 - 9	0
	DC	0 - 2 - 5	0	74 - 94	/
55.33	AC-DC	0 - 2 - 5	0	0	0
	AC	0 - 2 - 5	0	1 - 3 - 5	0
	DC	0 - 2 - 5	0	1 - 6 - 7 - 8 - 9	0
55.12/13/14	AC-DC	0 - 2 - 5	0	0	0 - 1

Descriptions: options and special versions

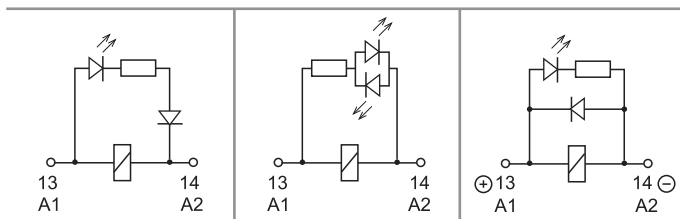

C: Option 3, 5, 54
LED (AC)

C: Option 6, 7, 74
Double LED
(DC non-polarized)

C: Option 8, 9, 94
LED + diode (DC, polarity
positive to pin A1/13)

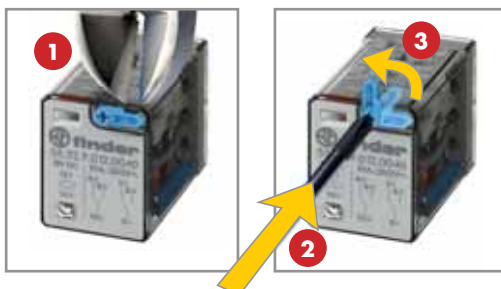

Lockable test button and mechanical flag indicator (0010, 0040, 0050, 0054, 0070, 0074, 0090, 0094)

The dual-purpose Finder test button can be used in two ways:

Case 1) The plastic pip (located directly above the test button) remains intact. In this case, when the test button is pushed, the contacts operate. When the test button is released the contacts return to their former state.

Case 2) The plastic pip is broken-off (using an appropriate cutting tool). In this case, (in addition to the above function), when the test button is pushed and rotated, the contacts are latched in the operating state, and remain so until the test button is rotated back to its former position. In both cases ensure that the test button actuation is swift and decisive.

Technical data

Insulation according to EN 61810-1		2 pole - 3 pole		4 pole	
Nominal voltage of supply system	V AC	230/400		230	
Rated insulation voltage	V AC	400		250	
Pollution degree		2		2	
Insulation between coil and contact set					
Type of Insulation		Basic		Basic	
Overvoltage category		III		III	
Rated impulse voltage	kV (1.2/50 μ s)	4		4	
Dielectric strength	V AC	2,000		2,000	
Insulation between adjacent contacts					
Type of insulation		Basic		Basic	
Overvoltage category		III		II	
Rated impulse voltage	kV (1.2/50 μ s)	4		2.5	
Dielectric strength	V AC	2,000		2,000	
Insulation between open contacts					
Type of disconnection		Micro-disconnection		Micro-disconnection	
Dielectric strength	V AC/kV (1.2/50 μ s)	1,000/1.5		1,000/1.5	
Conducted disturbance immunity					
Burst (5...50)ns, 5 kHz, on A1 - A2		EN 61000-4-4		level 4 (4 kV)	
Surge (1.2/50 μ s) on A1 - A2 (differential mode)		EN 61000-4-5		level 4 (4 kV)	
Other data					
Bounce time: NO/NC	ms	1/4			
Vibration resistance (5...55)Hz: NO/NC	g	15/15			
Shock resistance	g	16			
Power lost to the environment	without contact current	W	1		
	with rated current	W	3 (2 pole)	4 (3 pole)	3 (4 pole)
Recommended distance between relays mounted on PCB	mm	≥ 5			

Contact specification

F 55 - Electrical life (AC) v contact current
2 and 3 pole relays

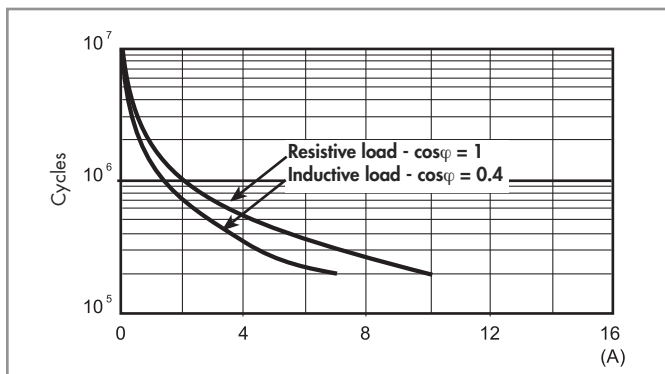

F 55 - Electrical life (AC) v contact current
4 pole relay

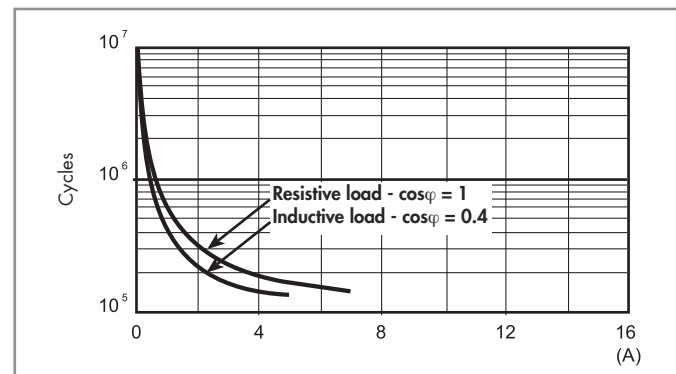

H 55 - Maximum DC1 breaking capacity

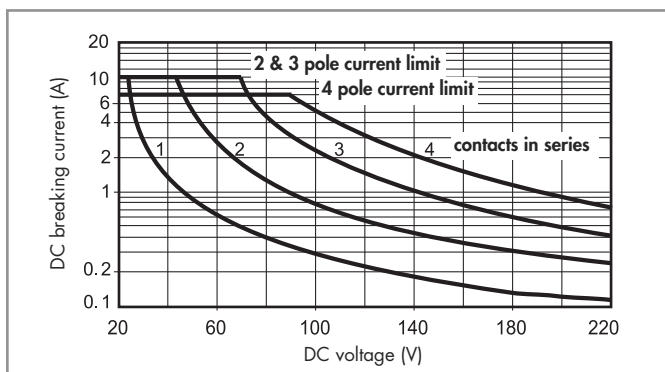

- When switching a resistive load (DC1) having voltage and current values under the curve, an electrical life of $\geq 100 \cdot 10^3$ can be expected.
- In the case of DC13 loads, the connection of a diode in parallel with the load will permit a similar electrical life as for a DC1 load. Note: the release time for the load will be increased.

Coil specifications

DC coil data

Nominal voltage U_N V	Coil code	Operating range		Resistance	Rated coil consumption I at U_N mA
		U_{min} V	U_{max} V	R Ω	
6	9.006	4.8	6.6	40	150
12	9.012	9.6	13.2	140	86
24	9.024	19.2	26.4	600	40
48	9.048	38.4	52.8	2,400	20
60	9.060	48	66	4,000	15
110	9.110	88	121	12,500	8.8
125	9.125	100	138	17,300	7.2
220	9.220	176	242	54,000	4

AC coil data

Nominal voltage U_N V	Coil code	Operating range		Resistance	Rated coil consumption I at U_N (50Hz) mA
		U_{min} V	U_{max} V	R Ω	
6	8.006	4.8	6.6	12	200
12	8.012	9.6	13.2	50	97
24	8.024	19.2	26.4	190	53
48	8.048	38.4	52.8	770	25
60	8.060	48	66	1,200	21
110	8.110	88	121	4,000	12.5
120	8.120	96	132	4,700	12
230	8.230	184	253	17,000	6
240	8.240	192	264	19,100	5.3

R 55 - DC coil operating range v ambient temperature

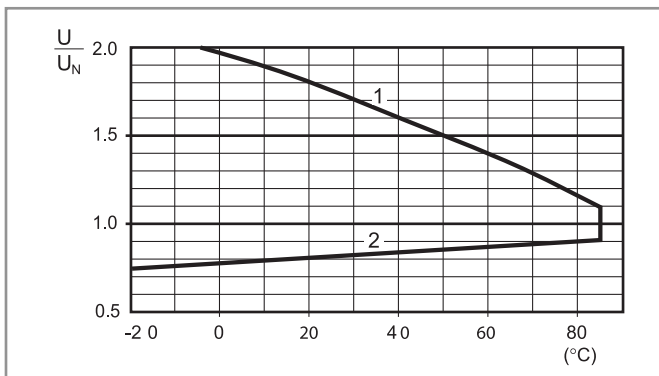

1 - Max. permitted coil voltage.
2 - Min. pick-up voltage with coil at ambient temperature.

R 55 - AC coil operating range v ambient temperature

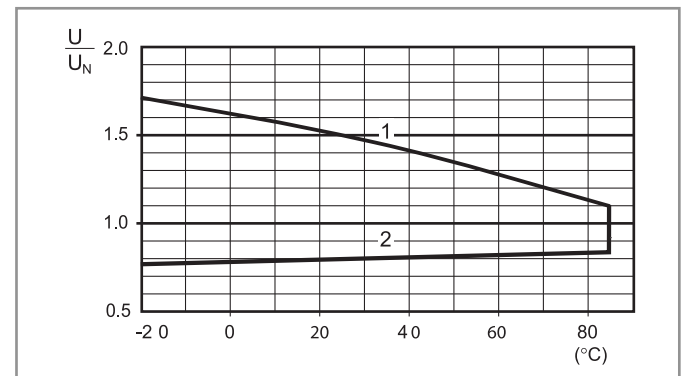

1 - Max. permitted coil voltage.
2 - Min. pick-up voltage with coil at ambient temperature.

Accessories



056.25



056.25 with relay

Top flange mount adaptor for 55.32, 55.33, 55.34

056.25

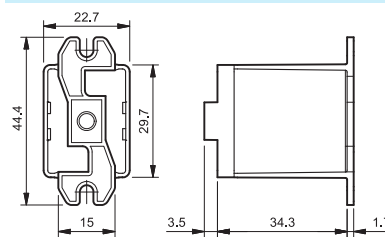

056.25

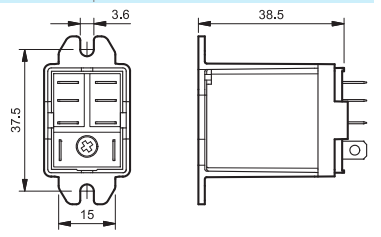

056.25 with relay



056.26



056.26 with relay

Rear flange mount adaptor for 55.32, 55.33, 55.34

056.26

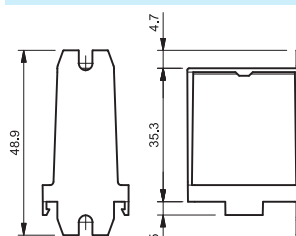

056.26

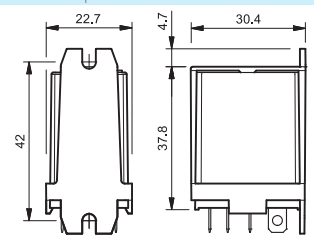

056.26 with relay



056.27



056.27 with relay

Top 35 mm rail (EN 60715) adaptor for 55.32, 55.33, 55.34

056.27

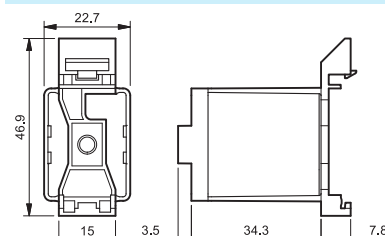

056.27

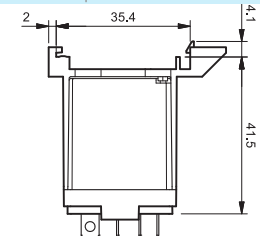

056.27 with relay



94.04
See page 7



Module	Socket	Relay	Description	Mounting	Accessories
99.02	94.02	55.32	Screw terminal (Box clamp) socket - Top terminals - Contacts - Bottom terminals - Coil	Panel or 35 mm rail (EN 60715) mount	- Coil indication and EMC suppression modules - Jumper link - Timer modules - Plastic retaining and release clip
	94.03	55.33			
	94.04	55.32 55.34			



94.54.1
See page 8



Module	Socket	Relay	Description	Mounting	Accessories
99.80	94.54.1	55.32 55.34	Screwless terminal socket - For fast cable connections - Top terminals - Contacts - Bottom terminals - Coil	35 mm rail (EN 60715) mount	- Coil indication and EMC suppression modules - Plastic retaining and release clip



94.74
See page 9



Module	Socket	Relay	Description	Mounting	Accessories
99.01	94.72	55.32	Screw terminal (Plate clamp) socket	Panel or 35 mm rail (EN 60715) mount	- Coil indication and EMC suppression modules - Metal retaining clip
	94.73	55.33			
	94.74	55.32 55.34			



94.82
See page 9



Module	Socket	Relay	Description	Mounting	Accessories
99.01	94.82	55.32	Screw terminal (Plate clamp) socket - 23 mm wide for space saving	Panel or 35 mm rail (EN 60715) mount	- Coil indication and EMC suppression modules - Metal retaining clip



94.84.3
See page 10



Module	Socket	Relay	Description	Mounting	Accessories
99.80	94.84.2	55.32 55.34	Screw terminal (Box clamp) socket	Panel or 35 mm rail (EN 60715) mount	- Coil indication and EMC suppression modules - Jumper link - Plastic retaining and release clip
	94.82.3	55.32			
	94.84.3	55.32 55.34			



94.94.3
See page 11



Module	Socket	Relay	Description	Mounting	Accessories
99.80	94.92.3	55.32	Screw terminal (Box clamp) socket - Top terminals - Contacts - Bottom terminals - Coil	Panel or 35 mm rail (EN 60715) mount	- Coil indication and EMC suppression modules - Jumper link - Plastic retaining and release clip
	94.94.3	55.32 55.34			



94.14
See page 12

Module	Socket	Relay	Description	Mounting	Accessories
-	94.12	55.32	PCB sockets	PCB mounting	- Metal retaining clip
-	94.13	55.33			
-	94.14	55.32 55.34			



94.22
See page 12

Module	Socket	Relay	Description	Mounting	Accessories
-	94.22	55.32	Panel mount with solder connections	Panel mount on 1 mm thick panel	- Metal retaining clip
-	94.23	55.33			
-	94.24	55.32 55.34			



94.34
See page 13

Module	Socket	Relay	Description	Mounting	Accessories
-	94.32	55.32	Panel mount with solder connections	M3 screw fixing	- Metal retaining clip
-	94.33	55.33			
-	94.34	55.32 55.34			



94.04

Approvals
(according to type):



Certain relay/socket combinations



094.91.3



060.72

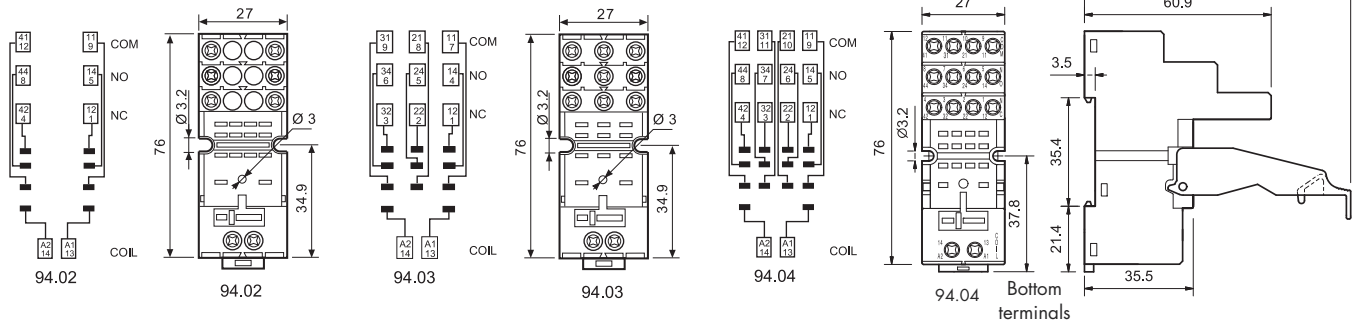

Screw terminal (Box clamp) socket panel or 35 mm (EN 60715) rail mount	94.02 Blue	94.02.0 Black	94.03 Blue	94.03.0 Black	94.04 Blue	94.04.0 Black
For relay type	55.32		55.33		55.32, 55.34	
Accessories						
Metal retaining clip	094.71					
Plastic retaining and release clip (supplied with socket - packaging code SPA)	094.91.3	094.91.30	094.91.3	094.91.30	094.91.3	094.91.30
6-way jumper link	094.06	094.06.0	094.06	094.06.0	094.06	094.06.0
Identification tag	094.00.4					
Modules (see table below)	99.02					
Timer modules (see table below)	86.30					
Sheet of marker tags for retaining and release clip 094.91.3 plastic, 72 tags, 6x12 mm	060.72					
Technical data						
Rated values	10 A - 250 V					
Dielectric strength	2 kV AC					
Protection category	IP 20					
Ambient temperature	°C -40...+70					
Screw torque	Nm 0.5					
Wire strip length	mm 8					
Max. wire size for 94.02/03/04 sockets	solid wire			stranded wire		
	mm ² 1x6 / 2x2.5			1x4 / 2x2.5		
	AWG 1x10 / 2x14			1x12 / 2x14		

094.06

6-way jumper link for 94.02, 94.03 and 94.04 sockets	094.06 (blue)	094.06.0 (black)
Rated values	10 A - 250 V	

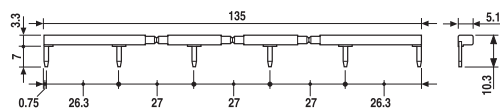

86.30



86 series timer modules	
(12...24)V AC/DC; Bi-function: AI, DI; (0.05s...100h)	86.30.0.024.0000
(110...125)V AC; Bi-function: AI, DI; (0.05s...100h)	86.30.8.120.0000
(230...240)V AC; Bi-function: AI, DI; (0.05s...100h)	86.30.8.240.0000

Approvals
(according to type):

99.02



Approvals
(according to type):



99.02 coil indication and EMC suppression modules for 94.02, 94.03 and 94.04 sockets		
Diode (+A1, standard polarity)	(6...220)V DC	99.02.3.000.00
LED	(6...24)V DC/AC	99.02.0.024.59
LED	(28...60)V DC/AC	99.02.0.060.59
LED	(110...240)V DC/AC	99.02.0.230.59
LED + Diode (+A1, standard polarity)	(6...24)V DC	99.02.9.024.99
LED + Diode (+A1, standard polarity)	(28...60)V DC	99.02.9.060.99
LED + Diode (+A1, standard polarity)	(110...220)V DC	99.02.9.220.99
LED + Varistor	(6...24)V DC/AC	99.02.0.024.98
LED + Varistor	(28...60)V DC/AC	99.02.0.060.98
LED + Varistor	(110...240)V DC/AC	99.02.0.230.98
RC circuit	(6...24)V DC/AC	99.02.0.024.09
RC circuit	(28...60)V DC/AC	99.02.0.060.09
RC circuit	(110...240)V DC/AC	99.02.0.230.09
Residual current by-pass	(110...240)V AC	99.02.8.230.07

DC Modules with non-standard polarity (+A2) on request.

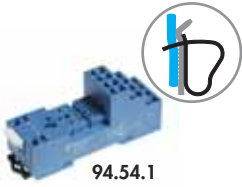

94.54.1

Approvals (according to type):



094.92



020.24

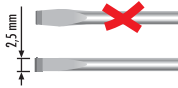

99.80

Approvals (according to type):



* Modules in Black housing are available on request.

Green LED is standard. Red LED available on request.

Screwless terminal socket 35 mm rail (EN 60715) mount	94.54.1 (blue)	94.54.10 (black)	
For relay type	55.32, 55.34		
Accessories			
Metal retaining clip		094.71	
Plastic retaining and release clip		094.92	
Modules (see table below)		99.80	
Sheet of marker tags for retaining and release clip 094.92 plastic, 24 tags, 9x17 mm		020.24	
Technical data			
Rated values	10 A - 250 V		
Dielectric strength	2 kV AC		
Protection category	IP 20		
Ambient temperature	°C	-25...+70	
Wire strip length	mm	7	
Max. wire size for 94.54.1 socket	solid wire	stranded wire	
	mm ²	2x(0.2...1.5)	2x(0.2...1.5)
	AWG	2x(24...18)	2x(24...18)

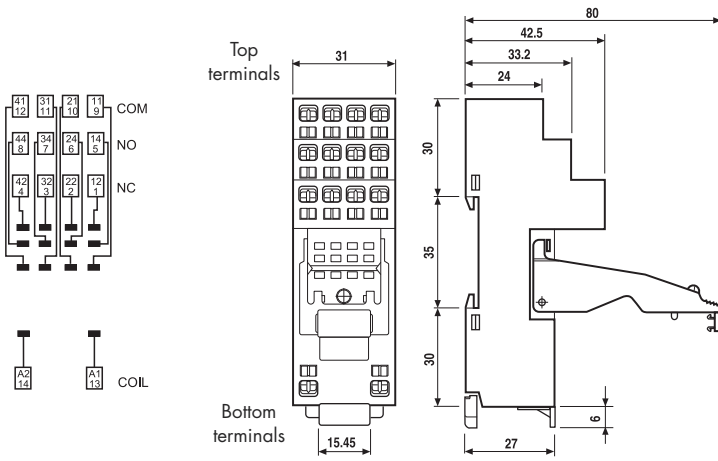

99.80 coil indication and EMC suppression modules for 94.54.1 socket		Blue*
Diode (+A1, standard polarity)	(6...220)V DC	99.80.3.000.00
LED	(6...24)V DC/AC	99.80.0.024.59
LED	(28...60)V DC/AC	99.80.0.060.59
LED	(110...240)V DC/AC	99.80.0.230.59
LED + Diode (+A1, standard polarity)	(6...24)V DC	99.80.9.024.99
LED + Diode (+A1, standard polarity)	(28...60)V DC	99.80.9.060.99
LED + Diode (+A1, standard polarity)	(110...220)V DC	99.80.9.220.99
LED + Varistor	(6...24)V DC/AC	99.80.0.024.98
LED + Varistor	(28...60)V DC/AC	99.80.0.060.98
LED + Varistor	(110...240)V DC/AC	99.80.0.230.98
RC circuit	(6...24)V DC/AC	99.80.0.024.09
RC circuit	(28...60)V DC/AC	99.80.0.060.09
RC circuit	(110...240)V DC/AC	99.80.0.230.09
Residual current by-pass	(110...240)V AC	99.80.8.230.07

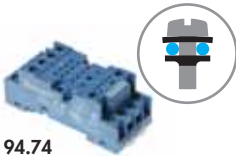

94.74

Approvals
(according to type):

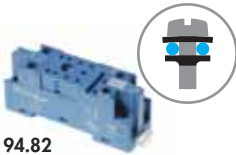

94.82

Approvals
(according to type):



Screw terminal (Plate clamp) socket panel or 35 mm (EN 60715) rail mount	94.72	94.72.0	94.73	94.73.0	94.74	94.74.0
	Blue	Black	Blue	Black	Blue	Black
For relay type	55.32		55.33		55.32, 55.34	
Accessories						
Metal retaining clip (supplied with socket - packaging code SMA)					094.71	
Modules (see table below)					99.01	
Screw terminal (Plate clamp) socket: panel or 35 mm rail mount	94.82 (blue)			94.82.0 (black)		
For relay type	55.32		55.32			
Accessories						
Metal retaining clip (supplied with socket - packaging code SMA)					094.71	
Modules (see table below)					99.01	
Technical data						
Rated values	10 A - 250 V					
Dielectric strength	2 kV AC					
Protection category	IP 20					
Ambient temperature	°C -40...+70					
⊕ Screw torque	Nm 0.5					
Wire strip length	mm 8 (94.72/73/74)			9 (94.82)		
Max. wire size for 94.72/73/74 and 94.82 sockets	solid wire			stranded wire		
	mm ² 1x2.5 / 2x1.5			1x2.5 / 2x1.5		
	AWG 1x14 / 2x16			1x14 / 2x16		

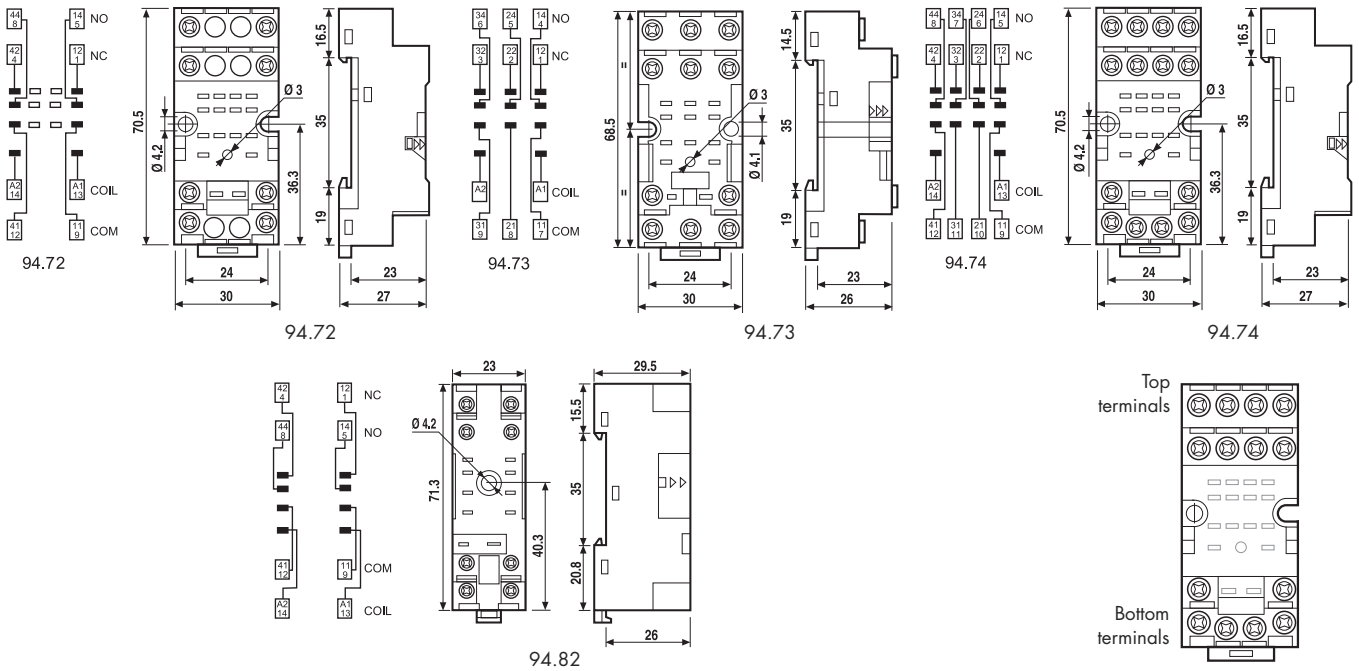

99.01

Approvals
(according to type):



99.01 coil indication and EMC suppression modules for 94.72, 94.73, 94.74 and 94.82 sockets		Blue*
Diode (+A1, standard polarity)	(6...220)V DC	99.01.3.000.00
Diode (+A2, non standard polarity)	(6...220)V DC	99.01.2.000.00
LED	(6...24)V DC/AC	99.01.0.024.59
LED	(28...60)V DC/AC	99.01.0.060.59
LED	(110...240)V DC/AC	99.01.0.230.59
LED + Diode (+A1, standard polarity)	(6...24)V DC	99.01.9.024.99
LED + Diode (+A1, standard polarity)	(28...60)V DC	99.01.9.060.99
LED + Diode (+A1, standard polarity)	(110...220)V DC	99.01.9.220.99
LED + Diode (+A2, non standard polarity)	(6...24)V DC	99.01.9.024.79
LED + Diode (+A2, non standard polarity)	(28...60)V DC	99.01.9.060.79
LED + Diode (+A2, non standard polarity)	(110...220)V DC	99.01.9.220.79
LED + Varistor	(6...24)V DC/AC	99.01.0.024.98
LED + Varistor	(28...60)V DC/AC	99.01.0.060.98
LED + Varistor	(110...240)V DC/AC	99.01.0.230.98
RC circuit	(6...24)V DC/AC	99.01.0.024.09
RC circuit	(28...60)V DC/AC	99.01.0.060.09
RC circuit	(110...240)V DC/AC	99.01.0.230.09
Residual current by-pass	(110...240)V AC	99.01.8.230.07

* Modules in Black housing are available on request.

Green LED is standard. Red LED available on request.

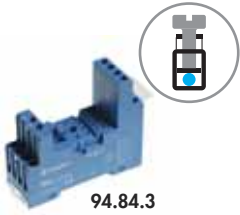

94.84.3

Approvals (according to type):

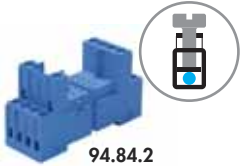

94.84.2

Approvals (according to type):



94.91.3

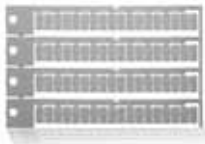

060.72

Screw terminal (Box clamp) socket panel or 35 mm (EN 60715) rail mount	94.82.3	94.82.30	94.84.3	94.84.30
	Blue	Black	Blue	Black
For relay type	55.32		55.32, 55.34	
Accessories				
Metal retaining clip (supplied with socket - packaging code SMA)	094.71			
Plastic retaining and release clip	094.91.3	094.91.30	094.91.3	094.91.30
6-way jumper link	094.06	094.06.0	094.06	094.06.0
Identification tag	094.80.3			
Modules (see table next page)	99.80			
Sheet of marker tags for retaining and release clip 094.91.3 plastic, 72 tags, 6x12 mm	060.72			
Screw terminal (Box clamp) socket panel or 35 mm (EN 60715) rail mount	94.84.2	94.84.20		
	Blue	Black		
For relay type	55.32, 55.34			
Accessories				
Metal retaining clip (supplied with socket - packaging code SMA)	094.71			
Plastic retaining and release clip	094.91.3		094.91.30	
6-way jumper link	094.06		094.06.0	
Identification tag	094.80.3			
Modules (see table next page)	99.80			
Sheet of marker tags for retaining and release clip 094.91.3 plastic, 72 tags, 6x12 mm	060.72			
Technical data				
Rated values	10 A - 250 V			
Dielectric strength	2 kV AC			
Protection category	IP 20			
Ambient temperature	°C	-40...+70		
⊕ Screw torque	Nm	0.5		
Wire strip length	mm	7		
Max. wire size for 94.82.3, 94.84.3 and 94.84.2 sockets		solid wire		stranded wire
	mm ²	1x6 / 2x2.5		1x4 / 2x2.5
	AWG	1x10 / 2x14		1x12 / 2x14

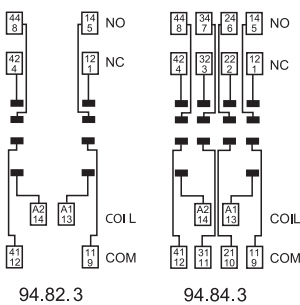

94.82.3

94.84.3

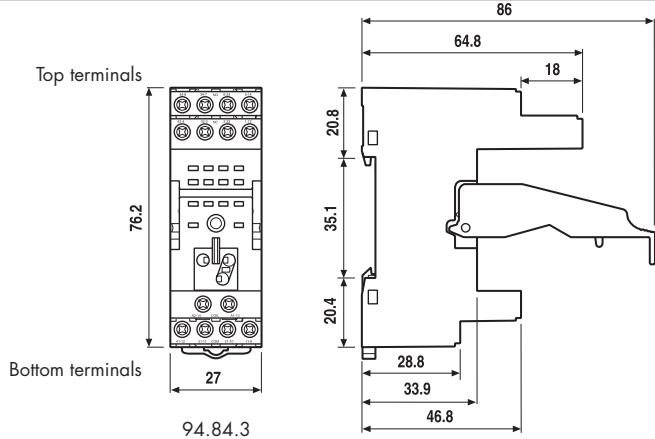

94.84.3

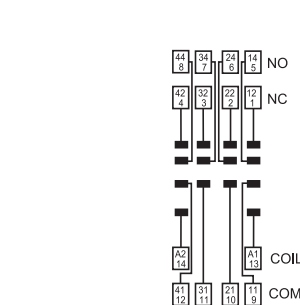

94.84.2

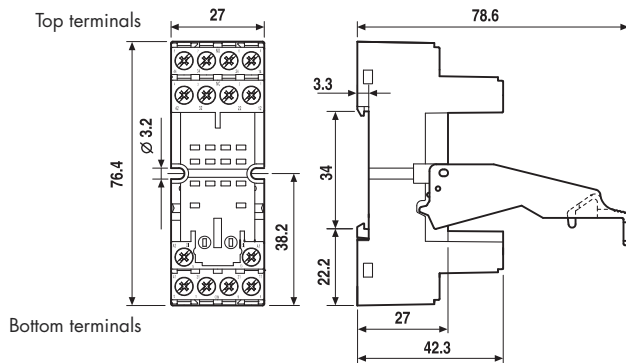

94.84.2



94.94.3

Approvals
(according to type):



094.91.3



060.72

Screw terminal (Box clamp) socket panel or 35 mm rail mount	94.92.3 (blue)	94.92.30 (black)	94.94.3 (blue)	94.94.30 (black)
For relay type	55.32		55.32, 55.34	
Accessories				
Metal retaining clip	094.71			
Plastic retaining and release clip	094.91.3	094.91.30	094.91.3	094.91.30
6-way jumper link	094.06	094.06.0	094.06	094.06.0
Identification tag	094.80.3			
Modules (see table below page)	99.80			
Sheet of marker tags for retaining and release clip 094.91.3 plastic, 72 tags, 6x12 mm	060.72			
Technical data				
Rated values	10 A - 250 V			
Dielectric strength	2 kV AC			
Protection category	IP 20			
Ambient temperature	°C	-25...+70		
Screw torque	Nm	0.5		
Wire strip length	mm	8		
Max. wire size for 94.92.3 and 94.94.3 sockets		solid wire		stranded wire
	mm ²	1x6 / 2x2.5		1x4 / 2x2.5
	AWG	1x10 / 2x14		1x12 / 2x14

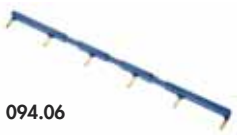
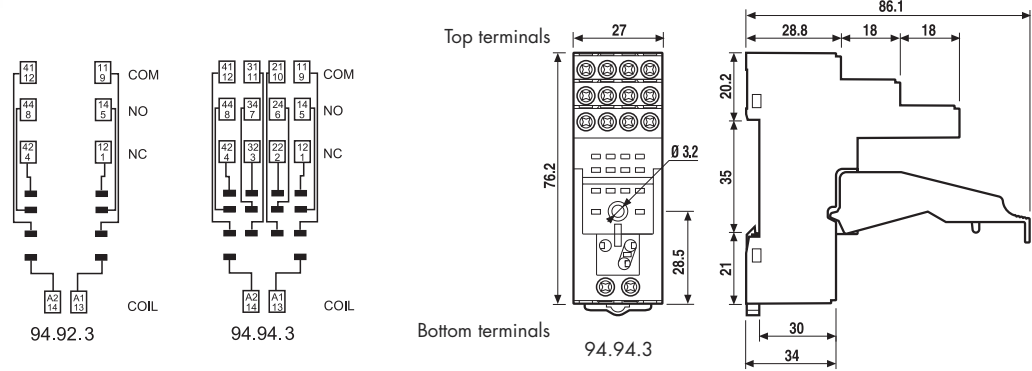

094.06

6-way jumper link for 94.84.2, 94.82.3, 94.84.3, 94.92.3 and 94.94.3 sockets	094.06 (blue)	094.06.0 (black)
Rated values	10 A - 250 V	

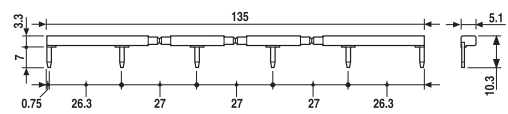

99.80

Approvals
(according to type):



* Modules in Black housing are available on request.

Green LED is standard. Red LED available on request.

99.80 coil indication and EMC suppression modules for 94.84.2, 94.82.3, 94.84.3, 94.92.3 and 94.94.3 sockets		Blue*
Diode (+A1, standard polarity)	(6...220)V DC	99.80.3.000.00
LED	(6...24)V DC/AC	99.80.0.024.59
LED	(28...60)V DC/AC	99.80.0.060.59
LED	(110...240)V DC/AC	99.80.0.230.59
LED + Diode (+A1, standard polarity)	(6...24)V DC	99.80.9.024.99
LED + Diode (+A1, standard polarity)	(28...60)V DC	99.80.9.060.99
LED + Diode (+A1, standard polarity)	(110...220)V DC	99.80.9.220.99
LED + Varistor	(6...24)V DC/AC	99.80.0.024.98
LED + Varistor	(28...60)V DC/AC	99.80.0.060.98
LED + Varistor	(110...240)V DC/AC	99.80.0.230.98
RC circuit	(6...24)V DC/AC	99.80.0.024.09
RC circuit	(28...60)V DC/AC	99.80.0.060.09
RC circuit	(110...240)V DC/AC	99.80.0.230.09
Residual current by-pass	(110...240)V AC	99.80.8.230.07



94.14
Approvals
(according to type):



PCB socket	94.12 Blue	94.12.0 Black	94.13 Blue	94.13.0 Black	94.14 Blue	94.14.0 Black
For relay type	55.32		55.33		55.32, 55.34	
Accessories						
Metal retaining clip (supplied with socket - packaging code SMA)	094.51					
Technical data						
Rated values	10 A - 250 V					
Dielectric strength	2 kV AC					
Ambient temperature	°C -40...+70					

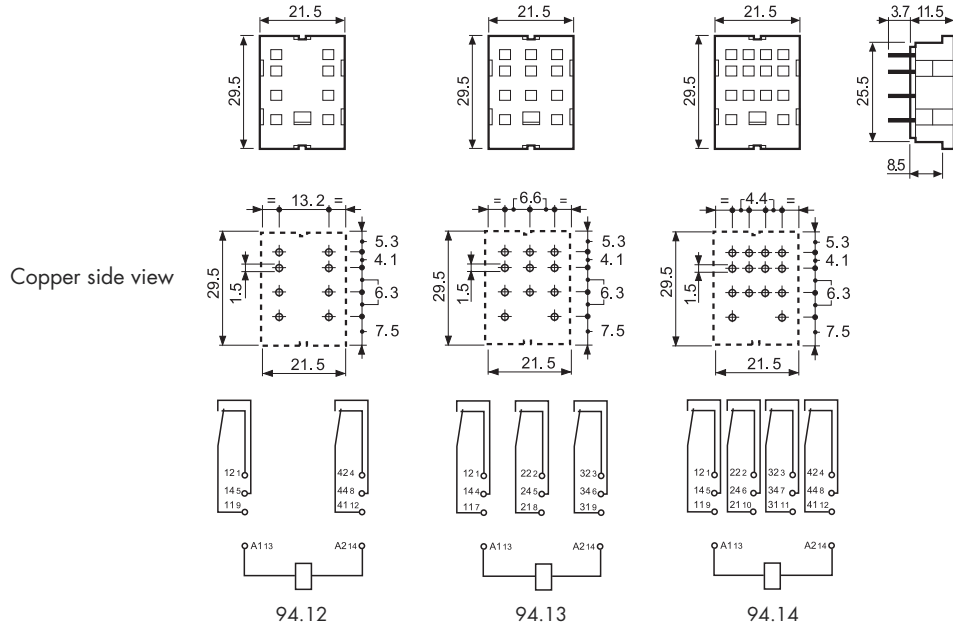

94.22
Approvals
(according to type):



Panel mount solder socket 1 mm thick panel	94.22 Blue	94.22.0 Black	94.23 Blue	94.23.0 Black	94.24 Blue	94.24.0 Black
For relay type	55.32		55.33		55.32, 55.34	
Accessories						
Metal retaining clip (supplied with socket - packaging code SMA)	094.51					
Technical data						
Rated values	10 A - 250 V					
Dielectric strength	2 kV AC					
Ambient temperature	°C -40...+70					

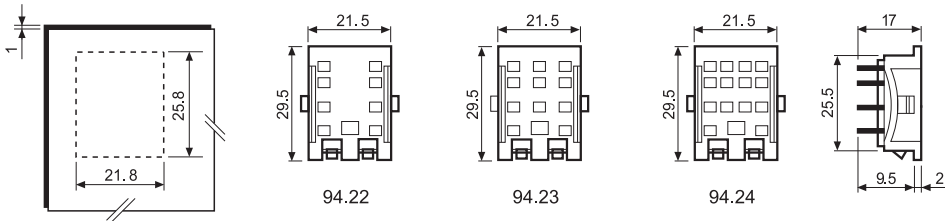



94.34

Approvals
(according to type):



Panel mount socket M3 screw fixing - solder connections	94.32 Blue	94.32.0 Black	94.33 Blue	94.33.0 Black	94.34 Blue	94.34.0 Black
For relay type	55.32		55.33		55.32, 55.34	
Accessories						
Metal retaining clip (supplied with socket - packaging code SMA)	094.51					
Technical data						
Rated values	10 A - 250 V					
Dielectric strength	2 kV AC					
Ambient temperature	°C -40...+70					

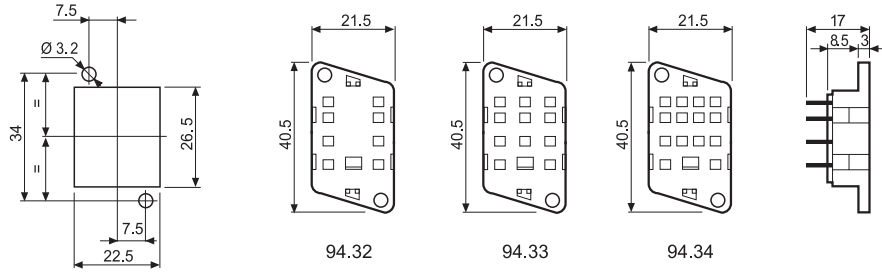

Packaging codes

How to code and identify retaining clip and packaging options for sockets.

Example:

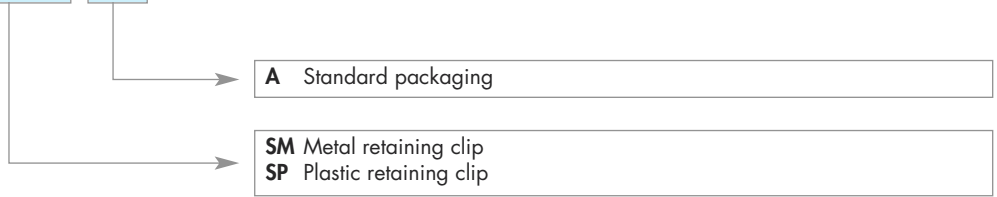

X-ON Electronics

Largest Supplier of Electrical and Electronic Components

Click to view similar products for [Industrial Relays](#) category:

Click to view products by [Finder](#) manufacturer:

Other Similar products are found below :

[6-1618400-7](#) [686-117111](#) [686-120111](#) [EV250-4A-02](#) [EV250-6A-01](#) [FCA-125-CX8](#) [FCA-410-138](#) [8-1618393-1](#) [GCA32A208VAC60HZ](#)
[GCA32A220VAC50/60HZ](#) [GCA32A230VAC50/60HZ](#) [GCA32A240VAC50/60HZ](#) [GCA32A48VAC60HZ](#) [GCA63A120VAC50/60HZ](#)
[GCA63A208VAC60HZ](#) [GCA63A220VAC60HZ](#) [GCA63A230VAC50/60HZ](#) [GCA63A240VAC50/60HZ](#) [GCA63A277VAC60HZ](#)
[GCA63A48VAC60HZ](#) [GCA63A500VAC50/60HZ](#) [GCA63A600VAC60HZ](#) [GCA800A200VACDC](#) [GCA95A110VAC50/60HZ](#)
[GCA95A120VAC50/60HZ](#) [GCA95A12VDC](#) [GCA95A240VAC50/60HZ](#) [GCA95A24VAC50/60HZ](#) [GCA95A48VAC60HZ](#) [ACC530U20](#)
[ACC730U30](#) [1395832-1](#) [RM699BV-3011-85-1005](#) [RMIA210230AC](#) [RMIA45024AC](#) [1423675-8](#) [B07B032AC1-0329](#) [B329](#) [1617807-1](#)
[N417](#) [P25-E5019-1](#) [P30C42A12D1-120](#) [2-1618398-1](#) [PBO-18A1218](#) [2307497](#) [RPYA00324LT](#) [RPYA003A120LT](#) [KR-4539-1](#)
[RT334012WG](#) [S160156115](#)