

Features

- Planar Die Construction
- 350mW Power Dissipation
- Zener Voltages from 2.4V - 51V
- Ideally Suited for Automated Assembly Processes
- **Totally Lead-Free & Fully RoHS Compliant (Notes 1 & 2)**
- **Halogen and Antimony Free. "Green" Device (Note 3)**
- **Qualified to AEC-Q101 Standards for High Reliability**

Mechanical Data

- Case: SOT23
- Case Material: Molded Plastic. UL Flammability Classification Rating 94V-0
- Moisture Sensitivity: Level 1 per J-STD-020
- Terminals: Matte Tin Finish annealed over Alloy 42 leadframe (Lead Free Plating). Solderable per MIL-STD-202, Method 208 ^(e3)
- Polarity: See Diagram
- Weight: 0.008 grams (approximate)

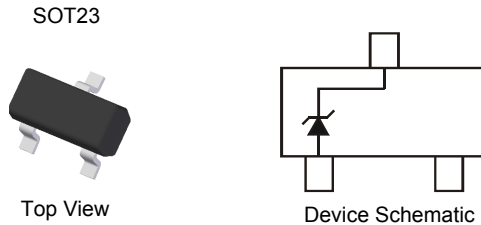

Ordering Information (Note 5)

Part Number	Compliance	Case	Packaging
(Type Number)-7-F	Standard	SOT23	3,000/Tape & Reel
(Type Number)Q-7-F	Automotive	SOT23	3,000/Tape & Reel
(Type Number)-13-F	Standard	SOT23	10,000/Tape & Reel
(Type Number)Q-13-F	Automotive	SOT23	10,000/Tape & Reel

*For (Type Number), please see the Electrical Characteristics Table. Example: 6.2V Zener = BZX84C6V2-7-F.

- Notes:
1. No purposely added lead. Fully EU Directive 2002/95/EC (RoHS) & 2011/65/EU (RoHS 2) compliant.
 2. See http://www.diodes.com/quality/lead_free.html for more information about Diodes Incorporated's definitions of Halogen- and Antimony-free, "Green" and Lead-free.
 3. Halogen- and Antimony-free "Green" products are defined as those which contain <900ppm bromine, <900ppm chlorine (<1500ppm total Br + Cl) and <1000ppm antimony compounds.
 4. BZX84C2V4-BZX84C39 products manufactured with Date Code OW (week 42, 2009) and newer are built with Green Molding Compound. BZX84C2V4-BZX84C39 products manufactured prior to Date Code OW are built with Non-Green Molding Compound and may contain Halogens or Sb₂O₃ Fire Retardants. BZX84C43-BZX84C51 products manufactured with Date Code V9 (week 33, 2008) and newer are built with Green Molding Compound. BZX84C43-BZX84C51 products manufactured prior to Date Code V9 are built with Non-Green Molding Compound and may contain Halogens or Sb₂O₃ Fire Retardants.
 5. For packaging details, go to our website at <http://www.diodes.com/products/packages.html>

Marking Information

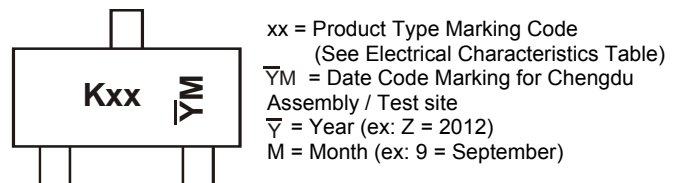
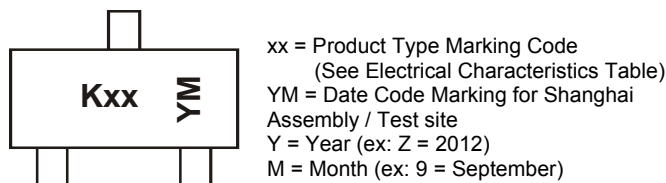

Date Code Key

Year	1998	...	2002	2003	2004	2005	2006	2007	2008	2009	2010	2011	2012	2013	2014	2015	2016	2017
Code	J	...	N	P	R	S	T	U	V	W	X	Y	Z	A	B	C	D	E

Month	Jan	Feb	Mar	Apr	May	Jun	Jul	Aug	Sep	Oct	Nov	Dec
Code	1	2	3	4	5	6	7	8	9	O	N	D

Maximum Ratings (@T_A = +25°C, unless otherwise specified.)

Characteristic	Symbol	Value	Unit
Forward Voltage @ I _F = 10mA	V _F	0.9	V

Thermal Characteristics

Characteristic	Symbol	Value	Unit
Power Dissipation (Note 6)	P _D	300	mW
Power Dissipation (Note 7)	P _D	350	mW
Thermal Resistance, Junction to Ambient Air (Note 6)	R _{θJA}	417	°C/W
Thermal Resistance, Junction to Ambient Air (Note 7)	R _{θJA}	357	°C/W
Operating and Storage Temperature Range	T _J , T _{STG}	-65 to +150	°C

Electrical Characteristics (@T_A = +25°C, unless otherwise specified.)

Type Number	Marking Code	Zener Voltage Range (Note 8)				Maximum Zener Impedance f = 1KHz			Maximum Reverse Current (Note 8)		Temperature Coefficient @ I _{ZT} mV/°C	
		V _Z @ I _{ZT}			I _{ZT}	Z _{ZT} @ I _{ZT}	Z _{ZK} @ I _{ZK}	I _R	V _R	Min	Max	
		Nom (V)	Min (V)	Max (V)	(mA)	(Ω)	(Ω)	(mA)	(μA)			(V)
BZX84C2V4	ZB	2.4	2.2	2.6	5.0	100	600	1.0	50	1.0	-3.5	0
BZX84C2V7	ZC	2.7	2.5	2.9	5.0	100	600	1.0	20	1.0	-3.5	0
BZX84C3V0	ZD	3.0	2.8	3.2	5.0	95	600	1.0	10	1.0	-3.5	0
BZX84C3V3	ZE	3.3	3.1	3.5	5.0	95	600	1.0	5.0	1.0	-3.5	0
BZX84C3V6	ZF	3.6	3.4	3.8	5.0	90	600	1.0	5.0	1.0	-3.5	0
BZX84C3V9	ZG	3.9	3.7	4.1	5.0	90	600	1.0	3.0	1.0	-3.5	0
BZX84C4V3	ZH	4.3	4.0	4.6	5.0	90	600	1.0	3.0	1.0	-3.5	0
BZX84C4V7	Z1	4.7	4.4	5.0	5.0	80	500	1.0	3.0	2.0	-3.5	0.2
BZX84C5V1	Z2	5.1	4.8	5.4	5.0	60	480	1.0	2.0	2.0	-2.7	1.2
BZX84C5V6	Z3	5.6	5.2	6.0	5.0	40	400	1.0	1.0	2.0	-2.0	2.5
BZX84C6V2	Z4	6.2	5.8	6.6	5.0	10	150	1.0	3.0	4.0	0.4	3.7
BZX84C6V8	Z5	6.8	6.4	7.2	5.0	15	80	1.0	2.0	4.0	1.2	4.5
BZX84C7V5	Z6	7.5	7.0	7.9	5.0	15	80	1.0	1.0	5.0	2.5	5.3
BZX84C8V2	Z7	8.2	7.7	8.7	5.0	15	80	1.0	0.7	5.0	3.2	6.2
BZX84C9V1	Z8	9.1	8.5	9.6	5.0	15	100	1.0	0.5	6.0	3.8	7.0
BZX84C10	Z9	10	9.4	10.6	5.0	20	150	1.0	0.2	7.0	4.5	8.0
BZX84C11	Y1	11	10.4	11.6	5.0	20	150	1.0	0.1	8.0	5.4	9.0
BZX84C12	Y2	12	11.4	12.7	5.0	25	150	1.0	0.1	8.0	6.0	10.0
BZX84C13	Y3	13	12.4	14.1	5.0	30	170	1.0	0.1	8.0	7.0	11.0
BZX84C15	Y4	15	13.8	15.6	5.0	30	200	1.0	0.1	10.5	9.2	13.0
BZX84C16	Y5	16	15.3	17.1	5.0	40	200	1.0	0.1	11.2	10.4	14.0
BZX84C18	Y6	18	16.8	19.1	5.0	45	225	1.0	0.1	12.6	12.4	16.0
BZX84C20	Y7	20	18.8	21.2	5.0	55	225	1.0	0.1	14.0	14.4	18.0
BZX84C22	Y8	22	20.8	23.3	5.0	55	250	1.0	0.1	15.4	16.4	-
BZX84C24	Y9	24	22.8	25.6	5.0	70	250	1.0	0.1	16.8	18.4	-
BZX84C27	YA	27	25.1	28.9	2.0	80	300	0.5	0.1	18.9	21.4	-
BZX84C30	YB	30	28.0	32.0	2.0	80	300	0.5	0.1	21.0	24.4	-
BZX84C33	YC	33	31.0	35.0	2.0	80	325	0.5	0.1	23.1	27.4	-
BZX84C36	YD	36	34.0	38.0	2.0	90	350	0.5	0.1	25.2	30.4	-
BZX84C39	YE	39	37.0	41.0	2.0	130	350	0.5	0.1	27.3	33.4	-
BZX84C43	YF	43	40.0	46.0	2.0	150	375	0.5	0.1	30.1	37.6	-
BZX84C47	YG	47	44.0	50.0	2.0	170	375	0.5	0.1	32.9	42.0	-
BZX84C51	YH	51	48.0	54.0	2.0	180	400	0.5	0.1	35.7	46.6	-

Notes: 6. Device mounted on FR-4 PC board with recommended pad layout, which can be found on our website at <http://www.diodes.com>.
7. Valid provided the terminals are kept at ambient temperature.
8. Short duration pulse test used to minimize self-heating effect.

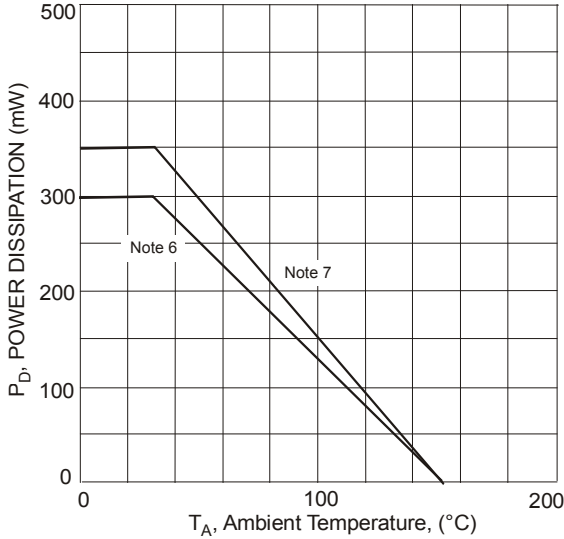

Fig. 1 Power Derating Curve

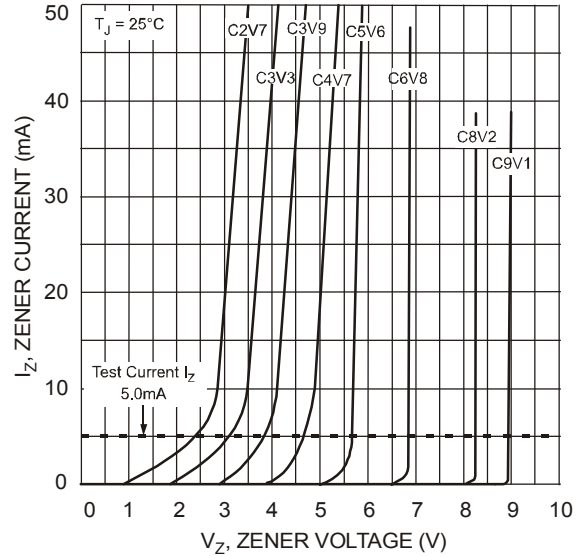

Fig. 2 Typical Zener Breakdown Characteristics

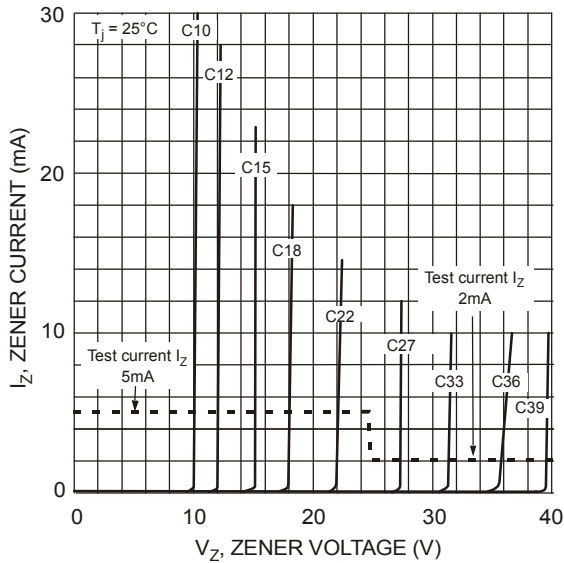

Fig. 3 Typical Zener Breakdown Characteristics

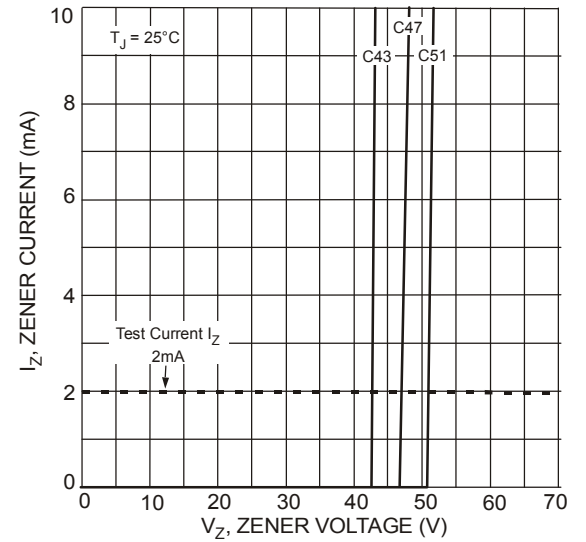

Fig. 4 Typical Zener Breakdown Characteristics

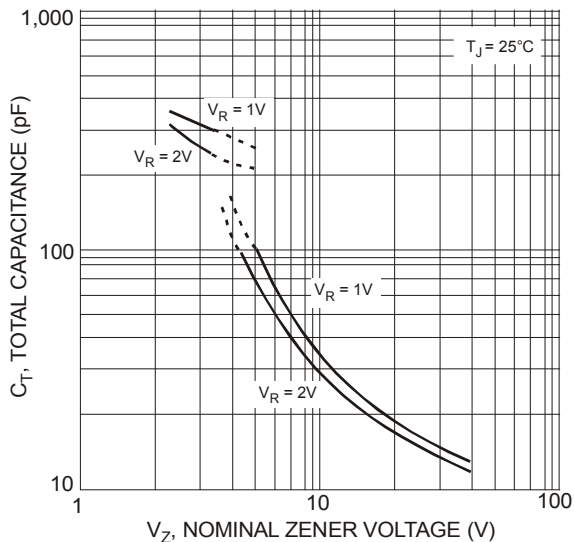

Fig. 5 Typical Total Capacitance vs. Nominal Zener Voltage

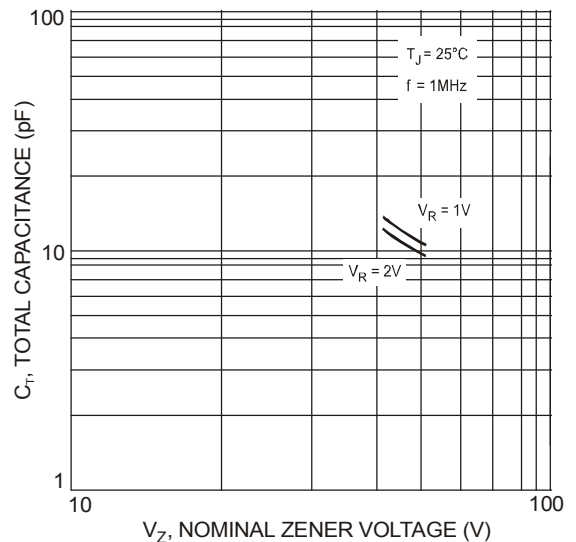
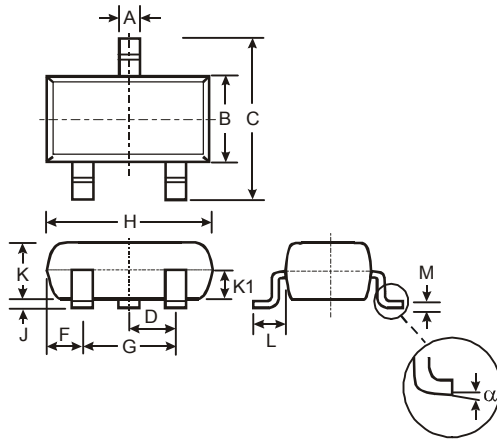

Fig. 6 Typical Total Capacitance vs. Nominal Zener Voltage

Package Outline Dimensions

Please see AP02002 at <http://www.diodes.com/datasheets/ap02002.pdf> for latest version.



SOT23			
Dim	Min	Max	Typ
A	0.37	0.51	0.40
B	1.20	1.40	1.30
C	2.30	2.50	2.40
D	0.89	1.03	0.915
F	0.45	0.60	0.535
G	1.78	2.05	1.83
H	2.80	3.00	2.90
J	0.013	0.10	0.05
K	0.903	1.10	1.00
K1	-	-	0.400
L	0.45	0.61	0.55
M	0.085	0.18	0.11
α	0°	8°	-
All Dimensions in mm			

Suggested Pad Layout

Please see AP02001 at <http://www.diodes.com/datasheets/ap02001.pdf> for latest version.

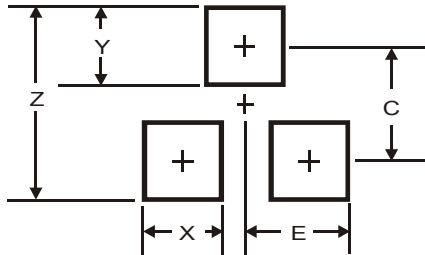

Dimensions	Value (in mm)
Z	2.9
X	0.8
Y	0.9
C	2.0
E	1.35

IMPORTANT NOTICE

DIODES INCORPORATED MAKES NO WARRANTY OF ANY KIND, EXPRESS OR IMPLIED, WITH REGARDS TO THIS DOCUMENT, INCLUDING, BUT NOT LIMITED TO, THE IMPLIED WARRANTIES OF MERCHANTABILITY AND FITNESS FOR A PARTICULAR PURPOSE (AND THEIR EQUIVALENTS UNDER THE LAWS OF ANY JURISDICTION).

Diodes Incorporated and its subsidiaries reserve the right to make modifications, enhancements, improvements, corrections or other changes without further notice to this document and any product described herein. Diodes Incorporated does not assume any liability arising out of the application or use of this document or any product described herein; neither does Diodes Incorporated convey any license under its patent or trademark rights, nor the rights of others. Any Customer or user of this document or products described herein in such applications shall assume all risks of such use and will agree to hold Diodes Incorporated and all the companies whose products are represented on Diodes Incorporated website, harmless against all damages.

Diodes Incorporated does not warrant or accept any liability whatsoever in respect of any products purchased through unauthorized sales channel. Should Customers purchase or use Diodes Incorporated products for any unintended or unauthorized application, Customers shall indemnify and hold Diodes Incorporated and its representatives harmless against all claims, damages, expenses, and attorney fees arising out of, directly or indirectly, any claim of personal injury or death associated with such unintended or unauthorized application.

Products described herein may be covered by one or more United States, international or foreign patents pending. Product names and markings noted herein may also be covered by one or more United States, international or foreign trademarks.

This document is written in English but may be translated into multiple languages for reference. Only the English version of this document is the final and determinative format released by Diodes Incorporated.

LIFE SUPPORT

Diodes Incorporated products are specifically not authorized for use as critical components in life support devices or systems without the express written approval of the Chief Executive Officer of Diodes Incorporated. As used herein:

A. Life support devices or systems are devices or systems which:

1. are intended to implant into the body, or
2. support or sustain life and whose failure to perform when properly used in accordance with instructions for use provided in the labeling can be reasonably expected to result in significant injury to the user.

B. A critical component is any component in a life support device or system whose failure to perform can be reasonably expected to cause the failure of the life support device or to affect its safety or effectiveness.

Customers represent that they have all necessary expertise in the safety and regulatory ramifications of their life support devices or systems, and acknowledge and agree that they are solely responsible for all legal, regulatory and safety-related requirements concerning their products and any use of Diodes Incorporated products in such safety-critical, life support devices or systems, notwithstanding any devices- or systems-related information or support that may be provided by Diodes Incorporated. Further, Customers must fully indemnify Diodes Incorporated and its representatives against any damages arising out of the use of Diodes Incorporated products in such safety-critical, life support devices or systems.

Copyright © 2014, Diodes Incorporated

www.diodes.com

X-ON Electronics

Largest Supplier of Electrical and Electronic Components

Click to view similar products for [Zener Diodes](#) category:

Click to view products by [Diodes Incorporated](#) manufacturer:

Other Similar products are found below :

[MMSZ5245BS-7-F](#) [RKZ13B2KG#P1](#) [RKZ5.6B2KJ#R1](#) [EDZTE6113B](#) [EDZTE6116B](#) [EDZTE616.8B](#) [1N747A](#) [1N966B](#) [NTE5116A](#)
[NTE5121A](#) [NTE5139A](#) [NTE5147A](#) [NTE5152A](#) [NTE5156A](#) [NTE5164A](#) [JANS1N4974US](#) [SMAJ4764A-TP](#) [RKZ5.1BKU#P6](#)
[3SMAJ5946B-TP](#) [3SMAJ5950B-TP](#) [3SMBJ5920B-TP](#) [3SMBJ5925B-TP](#) [TDZTR24](#) [441774C](#) [MMSZ4678-TP](#) [BZG04-36](#) [BZG05C9V1-](#)
[HE3-TR](#) [HZM30NBTR-E](#) [UDZTE-175.1B](#) [3SMAJ5945B-TP](#) [3SMAJ5947B-TP](#) [3SMBJ5941B-TP](#) [DL4746A-TP](#) [RKZ18B2KK#R1](#)
[RKZ10B2KL#R1](#) [RKZ6.8B2KL#R1](#) [RKZ8.2B2KL#R1](#) [DZ2S240M0L](#) [SMAZ27-TP](#) [SMBZ5920B-E3/52](#) [ZMM3.0](#) [RD16UM-T1-A](#) [RD39S-](#)
[T1-A](#) [RD9.1S-T1-A](#) [RD10S-T1-A](#) [RD20S-T1-A](#) [RD2.2S-T1-A](#) [RD2.7UM-T1-A](#) [HZM24NB1TL-E](#) [HZM2.7NB2TL-E](#)