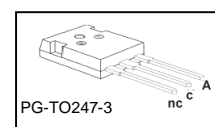
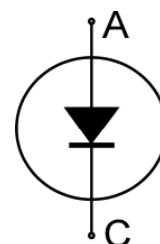

Fast Switching Emitter Controlled Diode

Features:

- 600V EmCon technology
- Fast recovery
- Soft switching
- Low reverse recovery charge
- Low forward voltage
- 175°C junction operating temperature
- Easy paralleling
- Pb-free lead plating; RoHS compliant
- Complete product spectrum and PSpice Models:
<http://www.infineon.com/emcon/>

Applications:

- Welding
- Motor drives

Type	V_{RRM}	I_F	$V_{F,T_j=25^\circ C}$	$T_{j,max}$	Marking	Package
IDW75E60	600V	75A	1.65V	175°C	D75E60	PG-TO247-3

Maximum Ratings

Parameter	Symbol	Value	Unit
Repetitive peak reverse voltage	V_{RRM}	600	V
Continuous forward current	I_F	120	A
$T_C = 25^\circ C$		82	
$T_C = 90^\circ C$		75	
Surge non repetitive forward current	I_{FSM}	220	A
$T_C = 25^\circ C, t_p = 10 \text{ ms, sine halfwave}$			
Maximum repetitive forward current	I_{FRM}	225	A
$T_C = 25^\circ C, t_p \text{ limited by } t_{j,max}, D = 0.5$			
Power dissipation	P_{tot}	300	W
$T_C = 25^\circ C$		170	
$T_C = 90^\circ C$		150	
$T_C = 100^\circ C$			
Operating junction temperature	T_j	-40...+175	°C
Storage temperature	T_{stg}	-55...+150	
Soldering temperature 1.6mm (0.063 in.) from case for 10 s	T_s	260	

Thermal Resistance

Parameter	Symbol	Conditions	Max. Value	Unit
Characteristic				
Thermal resistance, junction – case	R_{thJC}		0.5	K/W
Thermal resistance, junction – ambient	R_{thJA}		40	

Electrical Characteristic, at $T_j = 25\text{ }^\circ\text{C}$, unless otherwise specified

Parameter	Symbol	Conditions	Value			Unit
			min.	typ.	max.	

Static Characteristic

Collector-emitter breakdown voltage	V_{RRM}	$I_R=0.25\text{mA}$	600	-	-	V
Diode forward voltage	V_F	$I_F=75\text{A}$ $T_j=25\text{ }^\circ\text{C}$ $T_j=175\text{ }^\circ\text{C}$	-	1.65	2.0	
Reverse leakage current	I_R	$V_R=600\text{V}$ $T_j=25\text{ }^\circ\text{C}$ $T_j=175\text{ }^\circ\text{C}$	-	-	40	μA
			-	-	2500	

Dynamic Electrical Characteristics

Diode reverse recovery time	t_{rr}	$T_j=25\text{ }^\circ\text{C}$	-	121	-	ns
Diode reverse recovery charge	Q_{rr}	$V_R=400\text{V}$, $I_F=75\text{A}$,	-	2.4	-	μC
Diode peak reverse recovery current	I_{rr}	$dl_F/dt=1460\text{A}/\mu\text{s}$	-	38.5	-	A
Diode peak rate of fall of reverse recovery current during t_b	dl_{rr}/dt		-	921	-	$\text{A}/\mu\text{s}$

Diode reverse recovery time	t_{rr}	$T_j=125\text{ }^\circ\text{C}$	-	155	-	ns
Diode reverse recovery charge	Q_{rrm}	$V_R=400\text{V}$, $I_F=75\text{A}$,	-	4.4	-	μC
Diode peak reverse recovery current	I_{rr}	$dl_F/dt=1460\text{A}/\mu\text{s}$	-	46.6	-	A
Diode peak rate of fall of reverse recovery current during t_b	dl_{rr}/dt		-	960	-	$\text{A}/\mu\text{s}$

Diode reverse recovery time	t_{rr}	$T_j=175\text{ }^\circ\text{C}$	-	182	-	ns
Diode reverse recovery charge	Q_{rrm}	$V_R=400\text{V}$, $I_F=75\text{A}$,	-	5.8	-	μC
Diode peak reverse recovery current	I_{rr}	$dl_F/dt=1460\text{A}/\mu\text{s}$	-	56.2	-	A
Diode peak rate of fall of reverse recovery current during t_b	dl_{rr}/dt		-	1013	-	$\text{A}/\mu\text{s}$

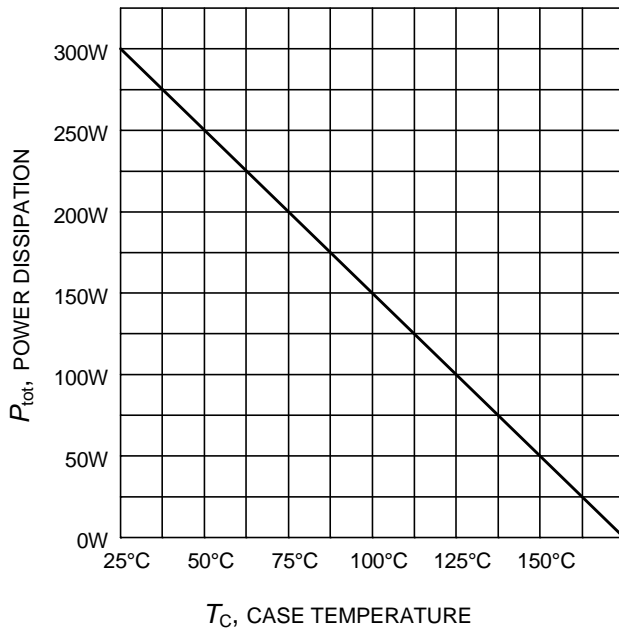

Figure 1. Power dissipation as a function of case temperature
($T_j \leq 175^\circ\text{C}$)

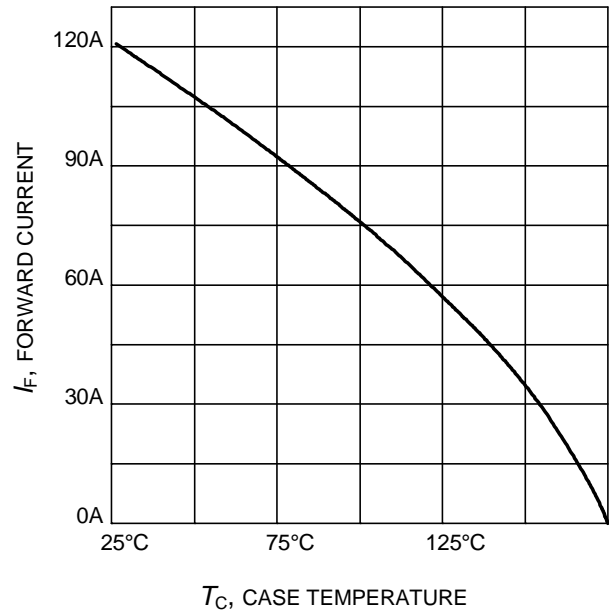

Figure 2. Diode forward current as a function of case temperature
($T_j \leq 175^\circ\text{C}$)

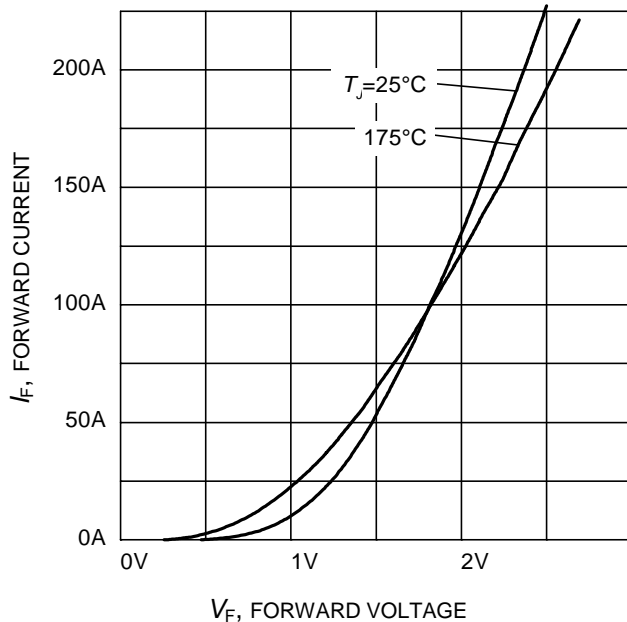

Figure 3. Typical diode forward current as a function of forward voltage

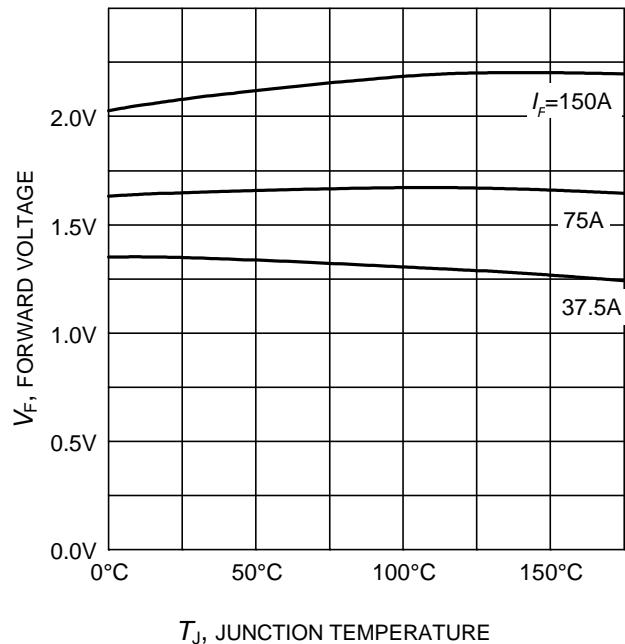

Figure 4. Typical diode forward voltage as a function of junction temperature

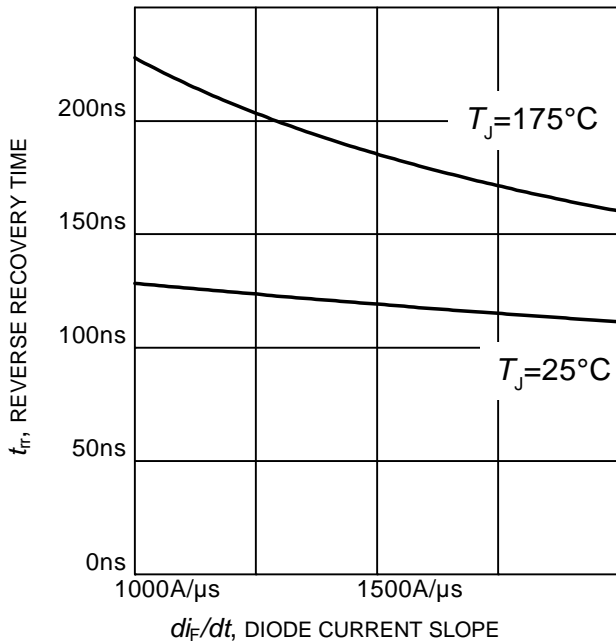

Figure 5. Typical reverse recovery time as a function of diode current slope
 ($V_R=400V$, $I_F=75A$,
 Dynamic test circuit in Figure E)

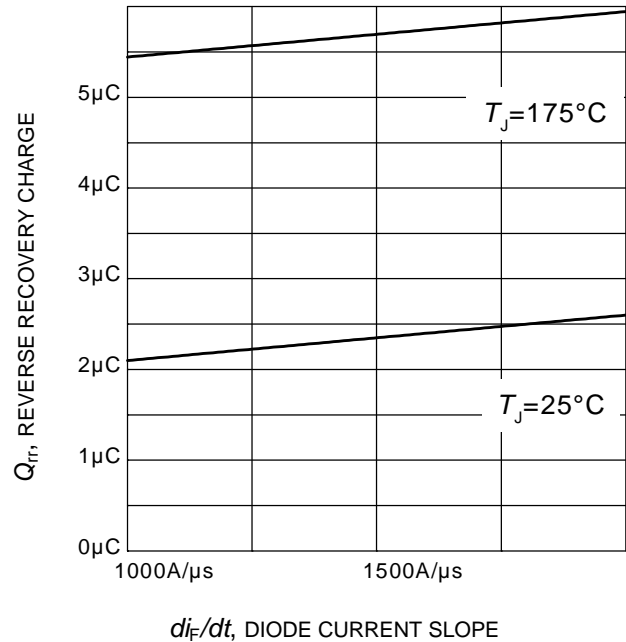

Figure 6. Typical reverse recovery charge as a function of diode current slope
 ($V_R = 400V$, $I_F = 75A$,
 Dynamic test circuit in Figure E)

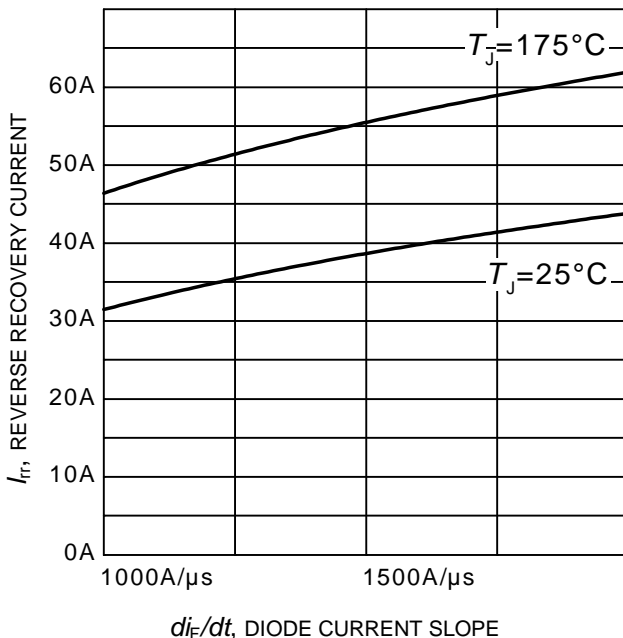

Figure 7. Typical reverse recovery current as a function of diode current slope
 ($V_R = 400V$, $I_F = 75A$,
 Dynamic test circuit in Figure E)

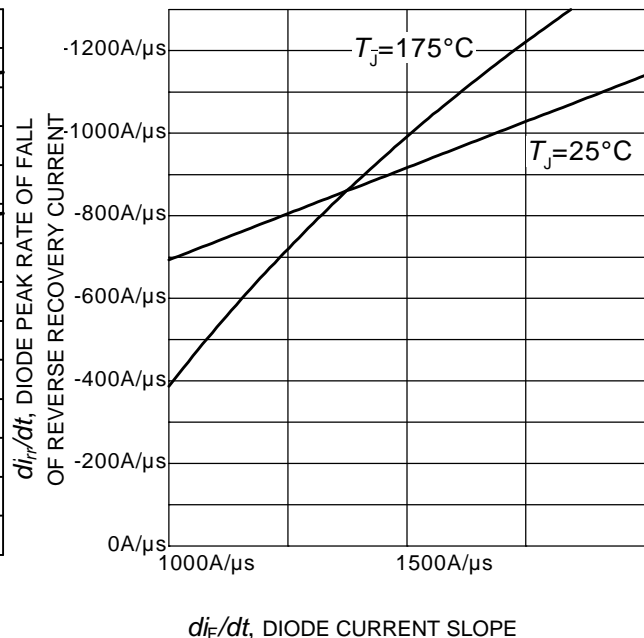

Figure 8. Typical diode peak rate of fall of reverse recovery current as a function of diode current slope
 ($V_R=400V$, $I_F=75A$,
 Dynamic test circuit in Figure E)

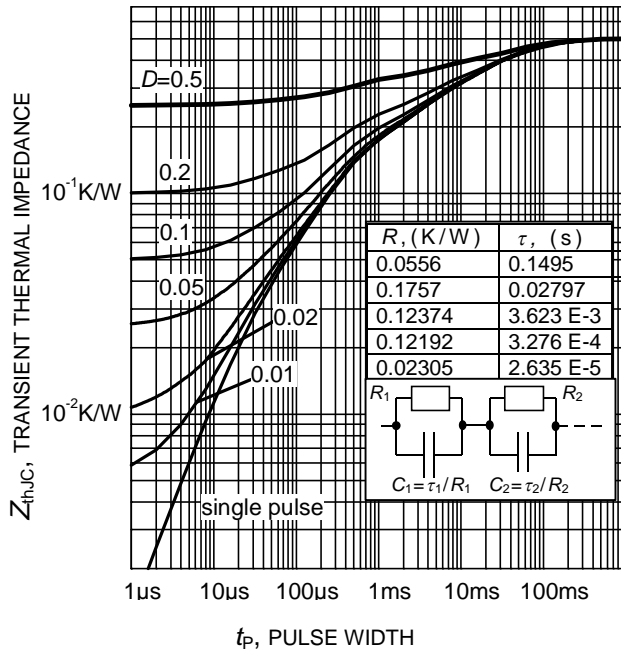
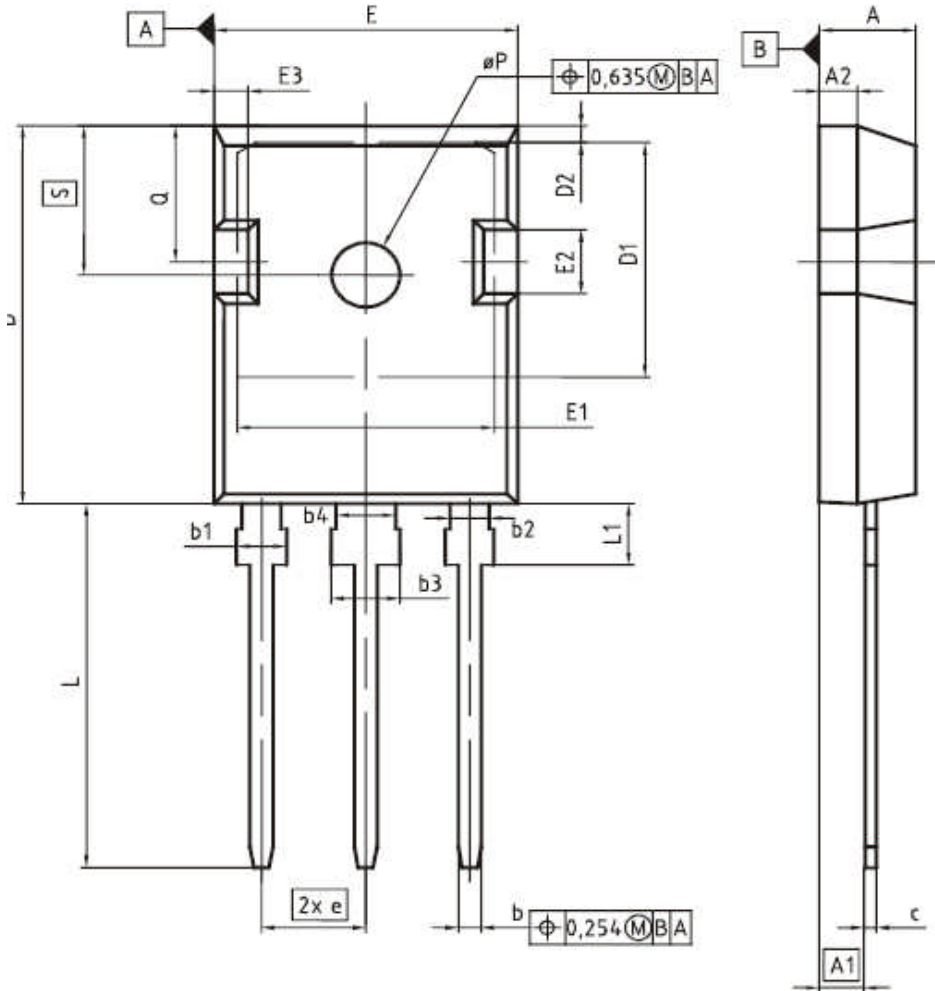

Figure 9. Diode transient thermal impedance as a function of pulse width
 $(D = t_p / T)$

PG-TO247-3



DIM	MILLIMETERS		INCHES	
	MIN	MAX	MIN	MAX
A	4,83	5,21	0,190	0,205
A1	2,27	2,54	0,089	0,100
A2	1,85	2,16	0,073	0,085
b	1,07	1,33	0,042	0,052
b1	1,90	2,41	0,075	0,095
b2	1,90	2,16	0,075	0,085
b3	2,87	3,38	0,113	0,133
b4	2,87	3,13	0,113	0,123
c	0,55	0,68	0,022	0,027
D	20,80	21,10	0,819	0,831
D1	16,25	17,65	0,640	0,695
D2	0,95	1,35	0,037	0,053
E	15,70	16,13	0,618	0,635
E1	13,10	14,15	0,516	0,557
E2	3,68	5,10	0,145	0,201
E3	1,00	2,60	0,039	0,102
e	5,44 (BSC)		0,214 (BSC)	
N	3		3	
L	19,80	20,32	0,780	0,800
L1	4,10	4,47	0,161	0,176
eP	3,50	3,70	0,138	0,146
Q	5,49	6,00	0,216	0,236
S	6,04	6,30	0,238	0,248

DOCUMENT NO.
Z8B00003327

SCALE

EUROPEAN PROJECTION

ISSUE DATE
09-07-2010

REVISION
05

Published by
Infineon Technologies AG
81726 Munich, Germany
© 2013 Infineon Technologies AG
All Rights Reserved.

Legal Disclaimer

The information given in this document shall in no event be regarded as a guarantee of conditions or characteristics. With respect to any examples or hints given herein, any typical values stated herein and/or any information regarding the application of the device, Infineon Technologies hereby disclaims any and all warranties and liabilities of any kind, including without limitation, warranties of non-infringement of intellectual property rights of any third party.

Information

For further information on technology, delivery terms and conditions and prices, please contact the nearest Infineon Technologies Office (www.infineon.com).

Warnings

Due to technical requirements, components may contain dangerous substances. For information on the types in question, please contact the nearest Infineon Technologies Office.

The Infineon Technologies component described in this Data Sheet may be used in life-support devices or systems and/or automotive, aviation and aerospace applications or systems only with the express written approval of Infineon Technologies, if a failure of such components can reasonably be expected to cause the failure of that life-support, automotive, aviation and aerospace device or system or to affect the safety or effectiveness of that device or system. Life support devices or systems are intended to be implanted in the human body or to support and/or maintain and sustain and/or protect human life. If they fail, it is reasonable to assume that the health of the user or other persons may be endangered.

X-ON Electronics

Largest Supplier of Electrical and Electronic Components

Click to view similar products for [Diodes - General Purpose, Power, Switching category](#):

Click to view products by [Infineon manufacturer](#):

Other Similar products are found below :

[MCL4151-TR3](#) [MMBD3004S-13-F](#) [RD0306T-H](#) [RGP30G-E373](#) [BAQ333-TR](#) [BAQ335-TR](#) [BAQ33-GS18](#) [BAS1602VH6327XT](#) [BAV17-TR](#) [BAV19-TR](#) [BAV301-TR](#) [BAW27-TAP](#) [NSVBAV23CLT1G](#) [NTE525](#) [1SS181-TP](#) [1SS184-TP](#) [1SS193,LF](#) [1SS193-TP](#) [1SS400CST2RA](#) [SBAV99LT3G](#) [SDAA13](#) [LL4448-GS18](#) [SHN2D02FUTW1T1G](#) [LS4150GS18](#) [LS4151GS08](#) [SMMBD7000LT3G](#) [1N4449](#) [1N4934-E3/73](#) [APT100DL60HJ](#) [RFUH20TB3S](#) [RGP30G-E354](#) [RGP30M-E3/73](#) [D291S45T](#) [MCL4151-TR](#) [BAS 16-02L E6327](#) [BAS 16-02V H6327](#) [BAS 21U E6327](#) [BAS 28 E6327](#) [BAS33-TAP](#) [BAS 70-02V H6327](#) [BAV300-TR](#) [BAV303-TR3](#) [BAW27-TR](#) [BAW56DWQ-7-F](#) [BAW56M3T5G](#) [BAW75-TAP](#) [BAW76-TR](#) [MM230L-CAA](#) [MMSD914-TP](#) [IDW40E65D1](#)