

Features

Plug-in - 12 A Power relay, 2 & 4 pole

- Flange mount option - (Faston 187, 4.8x0.5 mm termination)
- AC coils & DC coils
- Lockable test button and mechanical flag indicator
- Cadmium Free contacts (standard version)
- Contact material options
- 96 series sockets
- Coil EMC suppression
- Accessories

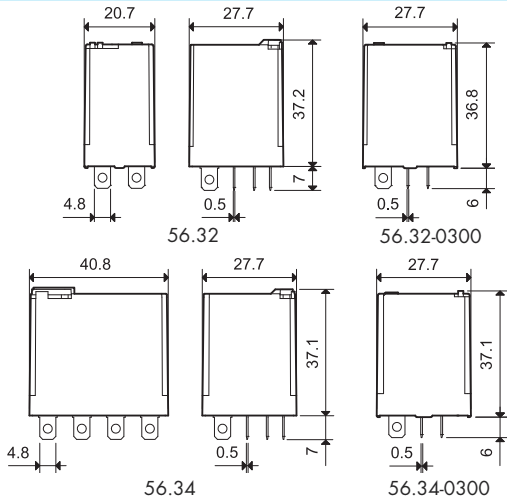

* For 4 CO (4PDT) or 4 NO only.

FOR UL HORSEPOWER AND PILOT DUTY RATINGS SEE "General technical information" page V

56.32/56.34



- 2 or 4 pole changeover contact
- Plug-in/Faston 187

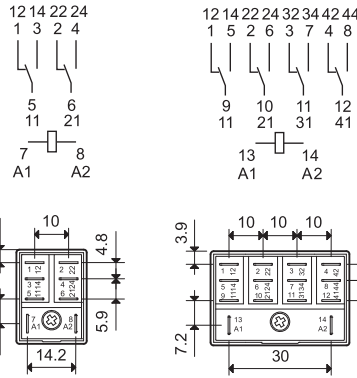

56.32

56.34

56.32-0300/56.34-0300



- 2 or 4 pole normally open contact (≥ 1.5 mm gap)
- Plug-in/Faston 187

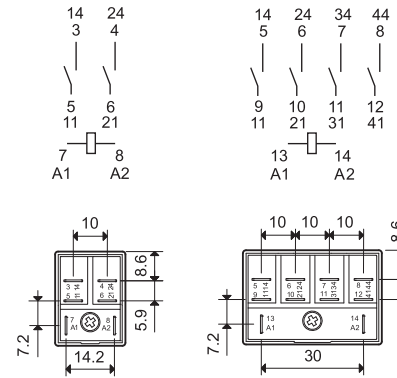

56.32-0300

56.34-0300

Contact specification

| | | | | |
|--|----------------------|-------------|--------------------------------|--------------------------------|
| Contact configuration | 2 CO (DPDT) | 4 CO (4PDT) | 2NO (DPSTNO) ≥ 1.5 mm gap | 4NO (4PSTNO) ≥ 1.5 mm gap |
| Rated current/Maximum peak current | A 12/20 | | 12/20 | |
| Rated voltage/Maximum switching voltage V AC | 250/400 | | 250/400 | |
| Rated load AC1 | VA 3,000 | | 3,000 | |
| Rated load AC15 (230 V AC) | VA 700 | | 700 | |
| Single phase motor rating (230 V AC) | kW 0.55 | | 0.55 | |
| Breaking capacity DC1: 30/110/220 V | A 12/0.5/0.25 | | 12/1/0.5 | |
| Minimum switching load | mW (V/mA) 500 (10/5) | | 500 (10/5) | |
| Standard contact material | AgNi | | AgNi | |

Coil specification

| | | | | |
|---------------------------|-----------------|--|-------------------|-------------------|
| Nominal voltage (U_N) | V AC (50/60 Hz) | 6 - 12 - 24 - 48 - 60 - 110 - 120 - 230 - 240 - 400* | | |
| | V DC | 6 - 12 - 24 - 48 - 60 - 110 - 125 - 220 | | — |
| Rated power AC/DC | VA (50 Hz)/W | 1.5/1 | 2/1.3 | 1.5/— 2/— |
| Operating range | AC | $(0.8...1.1)U_N$ | | $(0.85...1.1)U_N$ |
| | DC | $(0.8...1.1)U_N$ | $(0.85...1.1)U_N$ | — |
| Holding voltage | AC/DC | 0.8 U_N /0.6 U_N | | 0.85 U_N /— |
| Must drop-out voltage | AC/DC | 0.2 U_N /0.1 U_N | | 0.2 U_N /— |

Technical data

| | | | | |
|---|--------|--|---|-------------------------|
| Mechanical life AC/DC | cycles | 20 · 10 ⁶ /50 · 10 ⁶ | | 20 · 10 ⁶ /— |
| Electrical life at rated load AC1 | cycles | 100 · 10 ³ | | 100 · 10 ³ |
| Operate/release time | ms | 8/8 | | 8/4 |
| Insulation between coil and contacts (1.2/50 μ s) | kV | 4 | 5 | 4 5 |
| Dielectric strength between open contacts | V AC | 1,000 | | 2,000 |
| Ambient temperature range | °C | -40...+70 | | -40...+70 |
| Environmental protection | | RT I | | RT I |

Approvals (according to type)



Features

Printed circuit mount 12 A Power relay

- 2 & 4 pole
- AC coils & DC coils
- Cadmium Free contacts (standard version)
- Contact material option
- RT III (wash tight) option available

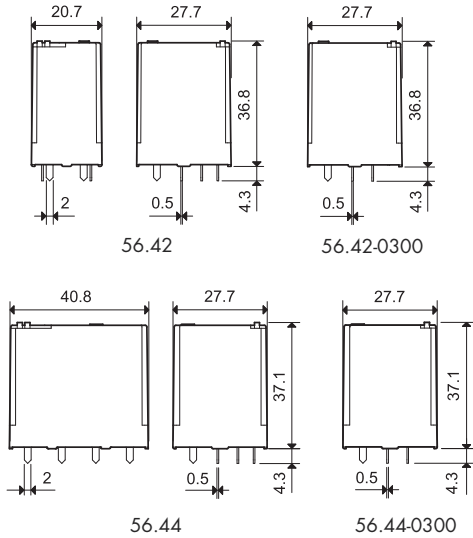

* For 4 CO (4PDT) or 4 NO only.

FOR UL HORSEPOWER AND PILOT DUTY RATINGS
SEE "General technical information" page V

56.42/56.44



- 2 or 4 pole changeover contact
- PCB mount

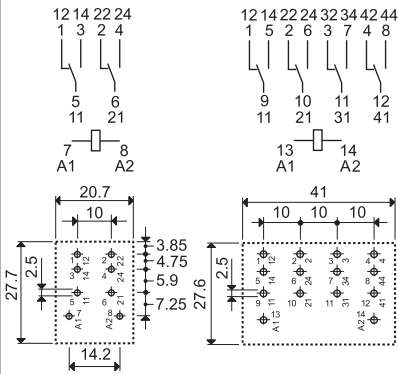

56.42
Copper side view

56.44
Copper side view

56.42-0300/56.44-0300



- 2 or 4 pole normally open contact
(≥ 1.5 mm gap)
- PCB mount

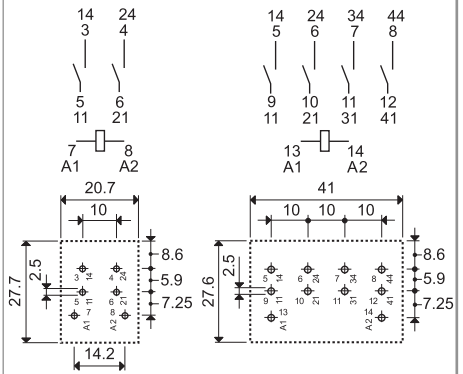

56.42-0300
Copper side view

56.44-0300
Copper side view

| Contact specification | | 2 CO (DPDT) | | 4 CO (4PDT) | | 2NO (DPSTNO) - ≥1.5mm gap | | 4NO (4PSTNO) - ≥1.5mm gap | |
|--|-----------------|--|--|----------------------------|--|----------------------------|--|---------------------------|--|
| Contact configuration | | 2 CO (DPDT) | | 4 CO (4PDT) | | 2NO (DPSTNO) - ≥1.5mm gap | | 4NO (4PSTNO) - ≥1.5mm gap | |
| Rated current/Maximum peak current | A | 12/20 | | 12/20 | | 12/20 | | 12/20 | |
| Rated voltage/Maximum switching voltage | V AC | 250/400 | | 250/400 | | 250/400 | | 250/400 | |
| Rated load AC1 | VA | 3,000 | | 3,000 | | 3,000 | | 3,000 | |
| Rated load AC15 (230 V AC) | VA | 700 | | 700 | | 700 | | 700 | |
| Single phase motor rating (230 V AC) | kW | 0.55 | | 0.55 | | 0.55 | | 0.55 | |
| Breaking capacity DC1: 30/110/220 V | A | 12/0.5/0.25 | | 12/0.5/0.25 | | 12/1/0.5 | | 12/1/0.5 | |
| Minimum switching load | mW (V/mA) | 500 (10/5) | | 500 (10/5) | | 500 (10/5) | | 500 (10/5) | |
| Standard contact material | | AgNi | | AgNi | | AgNi | | AgNi | |
| Coil specification | | | | | | | | | |
| Nominal voltage (U _N) | V AC (50/60 Hz) | 6 - 12 - 24 - 48 - 60 - 110 - 120 - 230 - 240 - 400* | | | | | | | |
| | V DC | 6 - 12 - 24 - 48 - 60 - 110 - 125 - 220 | | | | - | | | |
| Rated power AC/DC | VA (50 Hz)/W | 1.5/1 | | 2/1.3 | | 1.5/- | | 2/- | |
| Operating range | AC | (0.8...1.1)U _N | | | | (0.85...1.1)U _N | | | |
| | DC | (0.8...1.1)U _N | | (0.85...1.1)U _N | | - | | | |
| Holding voltage | AC/DC | 0.8 U _N /0.6 U _N | | | | 0.85 U _N /- | | | |
| Must drop-out voltage | AC/DC | 0.2 U _N /0.1 U _N | | | | 0.2 U _N /- | | | |
| Technical data | | | | | | | | | |
| Mechanical life AC/DC | cycles | 20 · 10 ⁶ /50 · 10 ⁶ | | | | 20 · 10 ⁶ /- | | | |
| Electrical life at rated load AC1 | cycles | 100 · 10 ³ | | | | 100 · 10 ³ | | | |
| Operate/release time | ms | 8/8 | | | | 8/4 | | | |
| Insulation between coil and contacts (1.2/50 μs) | kV | 4 | | 5 | | 4 | | 5 | |
| Dielectric strength between open contacts | V AC | 1,000 | | | | 2,000 | | | |
| Ambient temperature range | °C | -40...+70 | | | | -40...+70 | | | |
| Environmental protection | | RT I | | | | RT I | | | |
| Approvals (according to type) | | | | | | | | | |

Ordering information

Example: 56 series plug-in relay, 2 CO (DPDT), 12 V DC coil, lockable test button and mechanical indicator.

| | | | | | | | | | | | | | | | | | | | | | | | | | | |
|--------|---|---|------------------------|---|---|--------------------------------------|---|---|-----------------------------|---|---|-------------------------|---|---|--|---|---|--|---|---|--|--|--|---|--|--|
| 5 | 6 | . | 3 | . | 2 | . | 9 | . | 0 | 1 | 2 | . | 0 | A | 0 | B | 0 | C | 4 | D | 0 | | | | | |
| Series | | | Type | | | No. of poles | | | Coil version | | | Coil voltage | | | A: Contact material | | | B: Contact circuit | | | C: Options | | | D: Special versions | | |
| | | | 3 = Plug-in 4 = PCB | | | 2 = 2 pole, 12 A 4 = 4 pole, 12 A | | | 8 = AC (50/60 Hz) 9 = DC | | | See coil specifications | | | 0 = Standard AgNi 2 = AgCdO 4 = AgSnO ₂ | | | 0 = CO (nPDT) 3 = NO (nPST), ≥ 1.5 mm contact gap | | | 0 = None 2 = Mechanical indicator 3* = LED (AC) 4 = Lockable test button+mechanical indicator 5* = Lockable test button + LED (AC) 54* = Lockable test button + LED (AC) + mechanical indicator 6* = Double LED (DC non-polarized) 7* = Lockable test button + double LED (DC non-polarized) 74* = Lockable test button + double LED (DC non-polarized) + mechanical indicator 8* = LED + diode (DC, polarity positive to pin 7) for 56.32 only 9* = Lockable test button + LED + diode (DC, polarity positive to pin 7) for 56.32 only 94* = Lockable test button + LED + diode (DC, polarity positive to pin 7) + mechanical indicator for 56.32 only | | | 0 = Standard 1 = Wash tight (RT III) for 56.42 and 56.44 only 6 = Rear flange mount (4 pole only) 8 = Rear 35 mm rail mount (4 pole only) For other mounting options see page 6 | | |

Selecting features and options: only combinations in the same row are possible.
Preferred selections for best availability are shown in **bold**.

| Type | Coil version | A | B | C | D |
|-------|--------------|------------------|----------|----------------------------------|------------------|
| 56.32 | AC | 0 - 2 - 4 | 0 | 0 - 2 - 3 - 4 - 5 | 0 |
| | AC | 0 - 2 - 4 | 0 | 54 | / |
| | AC | 0 - 2 - 4 | 3 | 0 - 3 - 5 | 0 |
| | DC | 0 - 2 - 4 | 0 | 0 - 2 - 4 - 6 - 7 - 8 - 9 | 0 |
| | DC | 0 - 2 - 4 | 0 | 74 - 94 | / |
| 56.34 | AC | 0 - 2 - 4 | 0 | 0 - 2 - 3 - 4 - 5 | 0 - 6 - 8 |
| | AC | 0 - 2 - 4 | 0 | 54 | / |
| | AC | 0 - 2 - 4 | 0 - 3 | 0 - 3 - 5 | 0 |
| | DC | 0 - 2 - 4 | 0 | 0 - 2 - 4 - 6 - 7 | 0 - 6 - 8 |
| | DC | 0 - 2 - 4 | 0 | 74 | / |
| 56.42 | DC | 0 - 2 - 4 | 0 | 0 | 0 - 1 |
| | AC | 0 - 2 - 4 | 0 - 3 | 0 | 0 - 1 |
| 56.44 | AC-DC | 0 - 2 - 4 | 0 | 0 | 0 - 1 |
| | AC | 0 - 2 - 4 | 0 - 3 | 0 | 0 - 1 |

Special versions for Rail Applications on request

Descriptions: options and special versions

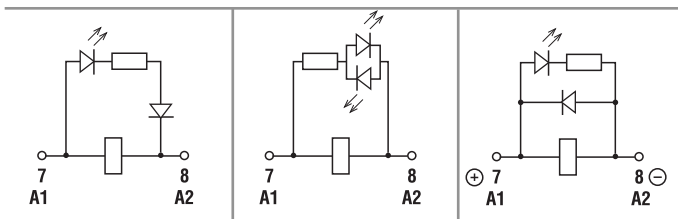

C: Option 3, 5, 54
LED (AC)

C: Option 6, 7, 74
Double LED
(DC non-polarized)

C: Option 8, 9, 94
LED + diode (DC, polarity positive to pin 7) - (56.32 only)

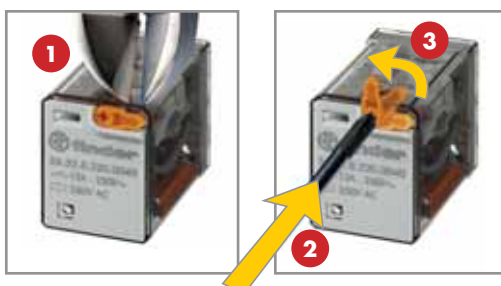

Lockable test button and mechanical flag indicator (0040, 0050, 0054, 0070, 0074, 0090, 0094)

The dual-purpose Finder test button can be used in two ways:

Case 1) The plastic pip (located directly above the test button) remains intact. In this case, when the test button is pushed, the contacts operate. When the test button is released the contacts return to their former state.

Case 2) The plastic pip is broken-off (using an appropriate cutting tool). In this case, (in addition to the above function), when the test button is pushed and rotated, the contacts are latched in the operating state, and remain so until the test button is rotated back to its former position.

In both cases ensure that the test button actuation is swift and decisive.

Technical data

*Only in applications where over voltage category II is permitted. In applications of over voltage category III: Micro-disconnection.

| Insulation according to EN 61810-1 | | 2 CO - 4 CO | | 2 NO - 4 NO | |
|--|-------------------------|---------------------|--------------------|---------------------|--------------------|
| Nominal voltage of supply system | V AC | 230/400 | | 230/400 | |
| Rated insulation voltage | V AC | 250 | 400 | 250 | 400 |
| Pollution degree | | 3 | 2 | 3 | 2 |
| Insulation between coil and contact set | | | | | |
| Type of insulation | | Basic | | Basic | |
| Overvoltage category | | III | | III | |
| Rated impulse voltage | kV (1.2/50 μs) | 4 | | 4 | |
| Dielectric strength | V AC | 2,500 | | 2,500 | |
| Insulation between adjacent contacts | | | | | |
| Type of insulation | | Basic | | Basic | |
| Overvoltage category | | III | | III | |
| Rated impulse voltage | kV (1.2/50 μs) | 4 | | 4 | |
| Dielectric strength | V AC | 2,500 | | 2,500 | |
| Insulation between open contacts | | | | | |
| Type of disconnection | | Micro-disconnection | | Full-disconnection* | |
| Overvoltage category | | — | | II | |
| Rated impulse voltage | kV (1.2/50 μs) | — | | 2.5 | |
| Dielectric strength | V AC/(1.2/50 μs) | 1,000/1.5 | | 2,000/3 | |
| Conducted disturbance immunity | | | | | |
| Burst (5...50) ns, 5 kHz, on A1 - A2 | | EN 61000-4-4 | | level 4 (4 kV) | |
| Surge (1.2/50 μs) on A1 - A2 (differential mode) | | EN 61000-4-5 | | level 4 (4 kV) | |
| Other data | | | | | |
| Bounce time: NO/NC | ms | 1/3 (changeover) | | 3/— (normally open) | |
| Vibration resistance (10...150 Hz): NO/NC | g | 17/14 | | | |
| Shock resistance NO/NC | g | 20/14 | | | |
| Power lost to the environment | without contact current | W | 1 (56.32, 56.42) | | 1.3 (56.34, 56.44) |
| | with rated current | W | 3.8 (56.32, 56.42) | | 6.9 (56.34, 56.44) |
| Recommended distance between relays mounted on PCB | mm | ≥ 5 | | | |

Contact specification

F 56 - Electrical life (AC) v contact current
2 - 4 pole relays

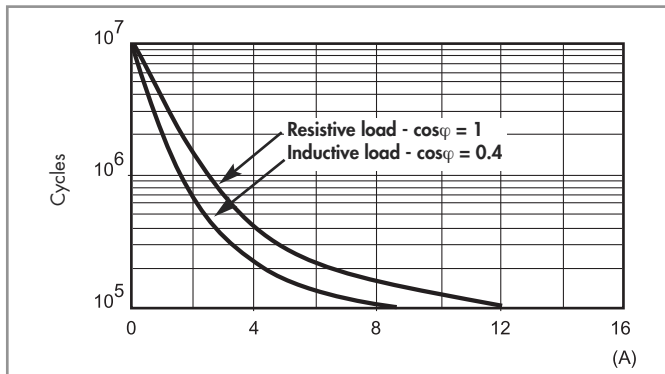

H 56 - Maximum DC1 breaking capacity
Changeover version

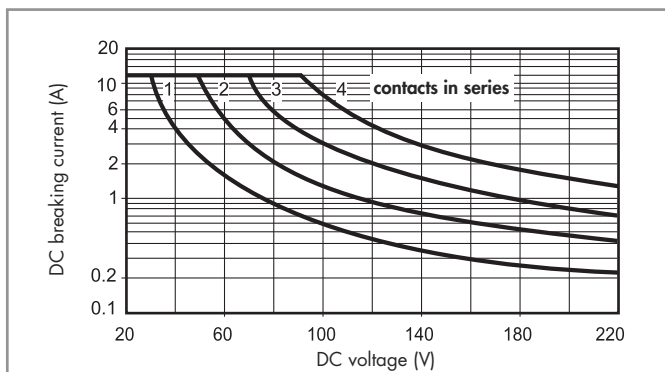

H 56 - Maximum DC1 breaking capacity
Normally open version

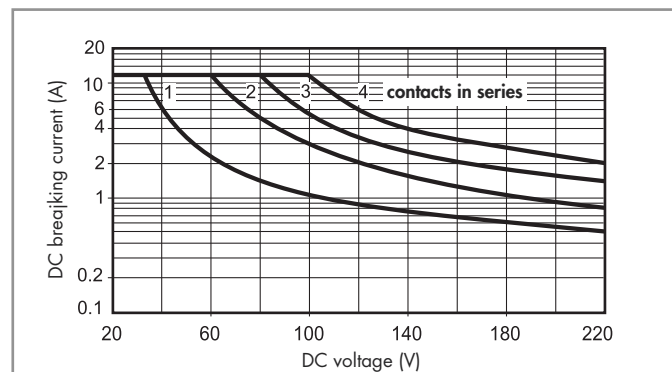

- When switching a resistive load (DC1) having voltage and current values under the curve, an electrical life of $\geq 100 \cdot 10^3$ can be expected.
- In the case of DC13 loads, the connection of a diode in parallel with the load will permit a similar electrical life as for a DC1 load.
Note: the release time of the load will be increased.

Coil specifications

DC coil data, 2 pole relay

| Nominal voltage U_N V | Coil code | Operating range | | Resistance R Ω | Rated coil consumption I at U_N mA |
|-------------------------------|-----------|-----------------|----------------|-----------------------------|--|
| | | U_{min} V | U_{max} V | | |
| 6 | 9.006 | 4.8 | 6.6 | 40 | 150 |
| 12 | 9.012 | 9.6 | 13.2 | 140 | 86 |
| 24 | 9.024 | 19.2 | 26.4 | 600 | 40 |
| 48 | 9.048 | 38.4 | 52.8 | 2,400 | 20 |
| 60 | 9.060 | 48 | 66 | 4,000 | 15 |
| 110 | 9.110 | 88 | 121 | 12,500 | 8.8 |
| 125 | 9.125 | 100 | 138 | 17,300 | 7.2 |
| 220 | 9.220 | 176 | 242 | 54,000 | 4 |

AC coil data, 2 pole relay

| Nominal voltage U_N V | Coil code | Operating range | | Resistance R Ω | Rated coil consumption I at U_N (50Hz) mA |
|-------------------------------|-----------|------------------|----------------|-----------------------------|---|
| | | U_{min}^* V | U_{max} V | | |
| 6 | 8.006 | 4.8 | 6.6 | 12 | 200 |
| 12 | 8.012 | 9.6 | 13.2 | 50 | 97 |
| 24 | 8.024 | 19.2 | 26.4 | 190 | 53 |
| 48 | 8.048 | 38.4 | 52.8 | 770 | 25 |
| 60 | 8.060 | 48 | 66 | 1,200 | 21 |
| 110 | 8.110 | 88 | 121 | 3,940 | 12.5 |
| 120 | 8.120 | 96 | 132 | 4,700 | 12 |
| 230 | 8.230 | 184 | 253 | 17,000 | 6 |
| 240 | 8.240 | 192 | 264 | 19,100 | 5.3 |

* $U_{min} = 0.85 U_N$ for normally open version.

DC coil data, 4 pole relay

| Nominal voltage U_N V | Coil code | Operating range | | Resistance R Ω | Rated coil consumption I at U_N mA |
|-------------------------------|-----------|-----------------|----------------|-----------------------------|--|
| | | U_{min} V | U_{max} V | | |
| 6 | 9.006 | 5.1 | 6.6 | 32.5 | 185 |
| 12 | 9.012 | 10.2 | 13.2 | 123 | 97 |
| 24 | 9.024 | 20.4 | 26.4 | 490 | 49 |
| 48 | 9.048 | 40.8 | 52.8 | 1,800 | 27 |
| 60 | 9.060 | 51 | 66 | 3,000 | 20 |
| 110 | 9.110 | 93.5 | 121 | 10,400 | 10.5 |
| 125 | 9.125 | 107 | 138 | 14,200 | 8.8 |
| 220 | 9.220 | 187 | 242 | 44,000 | 5 |

AC coil data, 4 pole relay or 4 NO

| Nominal voltage U_N V | Coil code | Operating range | | Resistance R Ω | Rated coil consumption I at U_N (50Hz) mA |
|-------------------------------|-----------|------------------|----------------|-----------------------------|---|
| | | U_{min}^* V | U_{max} V | | |
| 6 | 8.006 | 4.8 | 6.6 | 5.7 | 300 |
| 12 | 8.012 | 9.6 | 13.2 | 22 | 150 |
| 24 | 8.024 | 19.2 | 26.4 | 81 | 90 |
| 48 | 8.048 | 38.4 | 52.8 | 380 | 37 |
| 60 | 8.060 | 48 | 66 | 600 | 30 |
| 110 | 8.110 | 88 | 121 | 1,900 | 16.5 |
| 120 | 8.120 | 96 | 132 | 2,560 | 13.4 |
| 230 | 8.230 | 184 | 253 | 7,700 | 9 |
| 240 | 8.240 | 192 | 264 | 10,000 | 7.5 |
| 400 | 8.400 | 320 | 440 | 26,000 | 4.9 |

* $U_{min} = 0.85 U_N$ for normally open version.

R 56 - DC coil operating range v ambient temperature
2 pole relay

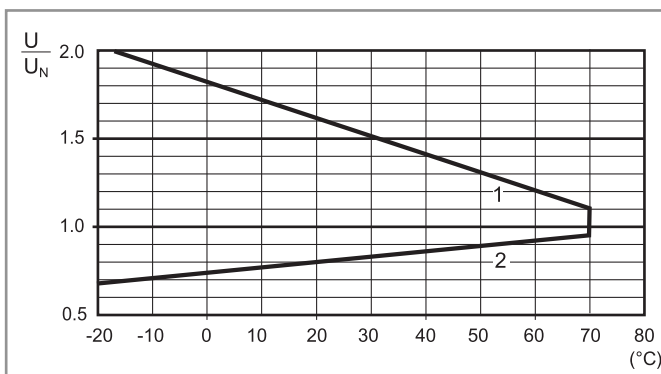

R 56 - AC coil operating range v ambient temperature
2 pole relay

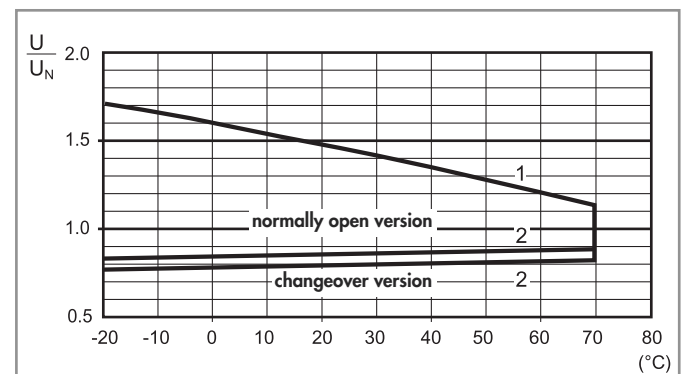

R 56 - DC coil operating range v ambient temperature
4 pole relay

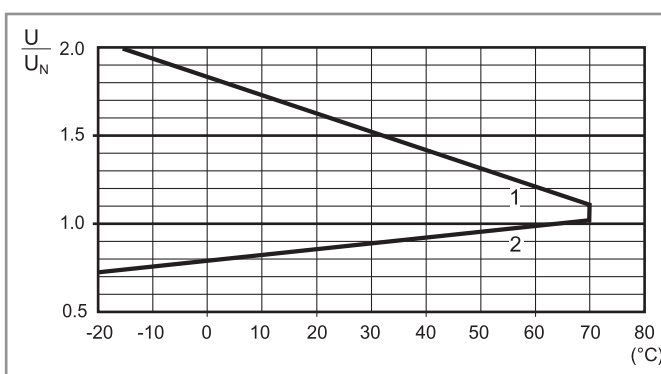

R 56 - AC coil operating range v ambient temperature
4 pole relay or 4 NO

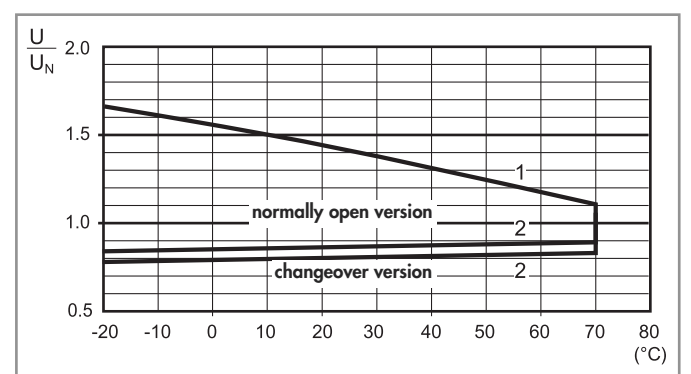

1 - Max. permitted coil voltage.
2 - Min. pick-up voltage with coil at ambient temperature.

1 - Max. permitted coil voltage.
2 - Min. pick-up voltage with coil at ambient temperature.

Accessories



056.25

056.25 with relay

Top flange mount adaptor for 56.32

056.25

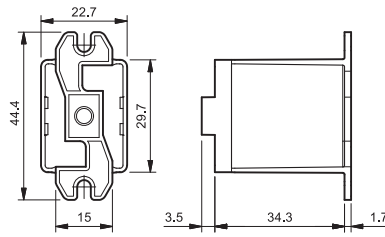

056.25

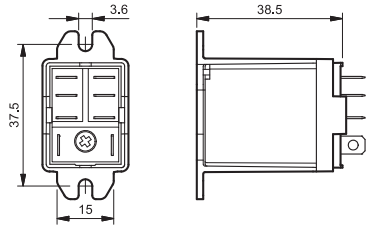

056.25 with relay



056.26

056.26 with relay

Rear flange mount adaptor for 56.32

056.26

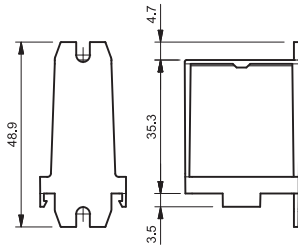

056.26

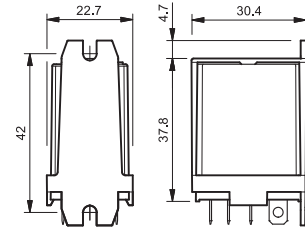

056.26 with relay



056.27

056.27 with relay

Top 35 mm rail (EN 60715) adaptor for 56.32

056.27

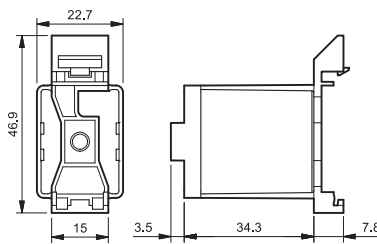

056.27

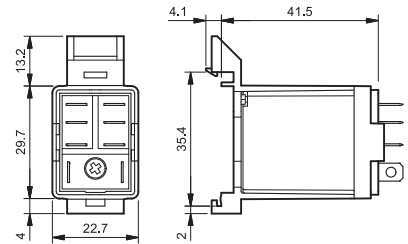

056.27 with relay



056.45

056.45 with relay

Top flange mount adaptor for 56.34

056.45

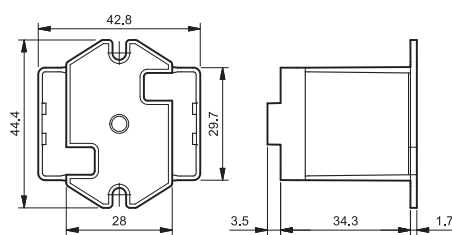

056.45

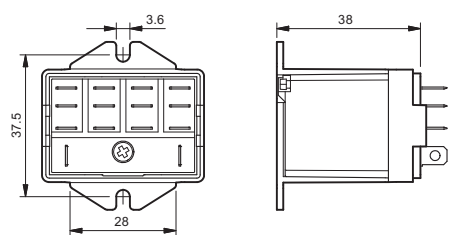

056.45 with relay



056.47

056.47 with relay

Top 35 mm rail (EN 60715) adaptor for 56.34

056.47

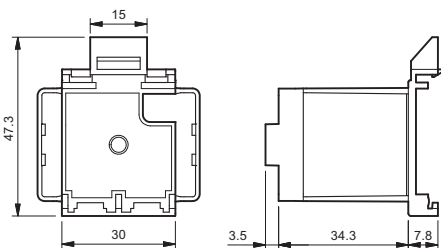

056.47

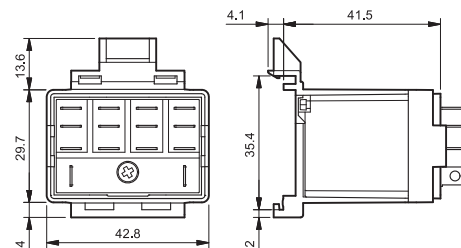

056.47 with relay

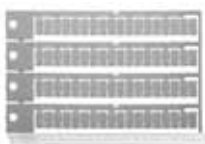

060.72

Sheet of marker tags for relay type 56.34, plastic, 72 tags, 6x12 mm

060.72

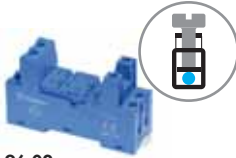

96.02
Approvals
(according to type):

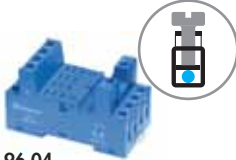

96.04
Approvals
(according to type):



094.91.3

| Screw terminal (Box clamp) socket panel or 35 mm (EN 60715) rail mount | 96.02 Blue | 96.02.0 Black | 96.04 Blue | 96.04.0 Black |
|--|--------------------------------|---------------|---------------|---------------|
| For relay type | 56.32 | | 56.34 | |
| Accessories | | | | |
| Metal retaining clip (supplied with socket - packaging code SMA) | 094.71 | | 096.71 | |
| Plastic retaining and release clip (supplied with socket - packaging code SPA) | 094.91.3 | 094.91.30 | — | — |
| 6-way jumper link | 094.06 | 094.06.0 | — | — |
| Identification tag | 095.00.4 | | 090.00.2 | |
| Modules (see table below) | 99.02 | | | |
| Timer modules (see table below) | 86.30 | | 86.00, 86.30 | |
| Sheet of marker tags for retaining and release clip 094.91.3 plastic, 72 tags, 6x12 mm | 060.72 | | — | |
| Technical data | | | | |
| Rated values | 12 A - 250 V | | | |
| Dielectric strength | 2 kV AC | | | |
| Protection category | IP 20 | | | |
| Ambient temperature | °C -40...+70 (see diagram L96) | | | |
| ⊕ Screw torque | Nm | 0.8 | | |
| Wire strip length | mm | 8 | | |
| Max. wire size for 94.02/04 sockets | | solid wire | stranded wire | |
| | mm ² | 1x6 / 2x2.5 | | 1x4 / 2x2.5 |
| | AWG | 1x10 / 2x14 | | 1x12 / 2x14 |

L 96 - Rated current vs ambient temperature

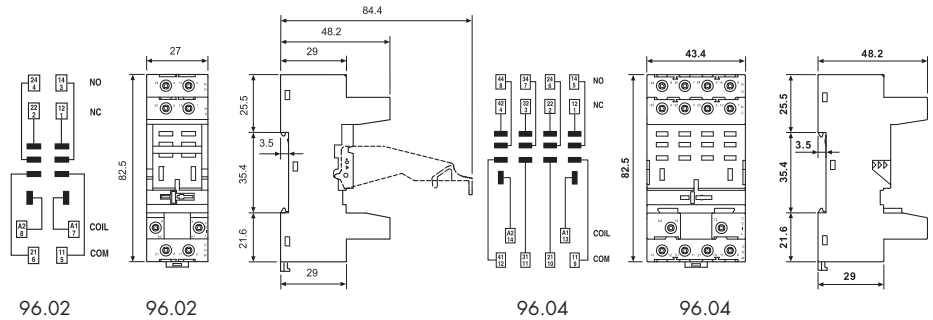
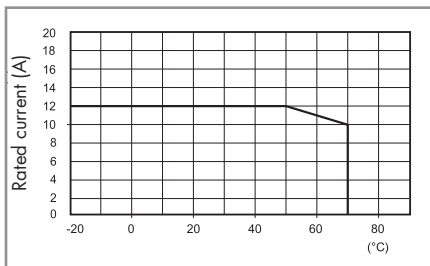

094.06

| 6-way jumper link for 96.02 socket | 094.06 (blue) | 094.06.0 (black) |
|------------------------------------|---------------|------------------|
| Rated values | 10 A - 250 V | |

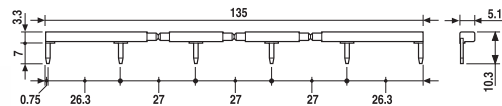

86.00

| 86 series timer modules | | |
|--|------------------|--|
| Multi-voltage: (12...240)V AC/DC; | | |
| Multi-functions: AI, DI, SW, BE, CE, DE, EE, FE; (0.05 s... 100 h) | 86.00.0.240.0000 | |
| (12...24)V AC/DC; Bi-function: AI, DI; (0.05 s... 100 h) | 86.30.0.024.0000 | |
| (110...125)V AC; Bi-function: AI, DI; (0.05s...100h) | 86.30.8.120.0000 | |
| (230...240)V AC; Bi-function: AI, DI; (0.05 s... 100 h) | 86.30.8.240.0000 | |



86.30

Approvals (according to type):



99.02

Approvals
(according to type):



DC Modules with non-standard polarity (+A2) on request.

| 99.02 coil indication and EMC suppression modules for 96.02 and 96.04 sockets | | |
|--|--------------------|----------------|
| Diode (+A1, standard polarity) | (6...220)V DC | 99.02.3.000.00 |
| LED | (6...24)V DC/AC | 99.02.0.024.59 |
| LED | (28...60)V DC/AC | 99.02.0.060.59 |
| LED | (110...240)V DC/AC | 99.02.0.230.59 |
| LED + Diode (+A1, standard polarity) | (6...24)V DC | 99.02.9.024.99 |
| LED + Diode (+A1, standard polarity) | (28...60)V DC | 99.02.9.060.99 |
| LED + Diode (+A1, standard polarity) | (110...220)V DC | 99.02.9.220.99 |
| LED + Varistor | (6...24)V DC/AC | 99.02.0.024.98 |
| LED + Varistor | (28...60)V DC/AC | 99.02.0.060.98 |
| LED + Varistor | (110...240)V DC/AC | 99.02.0.230.98 |
| RC circuit | (6...24)V DC/AC | 99.02.0.024.09 |
| RC circuit | (28...60)V DC/AC | 99.02.0.060.09 |
| RC circuit | (110...240)V DC/AC | 99.02.0.230.09 |
| Residual current by-pass | (110...240)V AC | 99.02.8.230.07 |

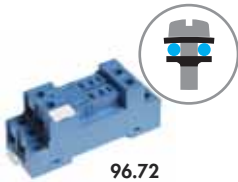

96.72

Approvals
(according to type):

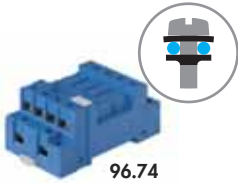

96.74

Approvals
(according to type):



99.01

Approvals
(according to type):



* Modules in Black housing are available on request.

Green LED is standard. Red LED available on request.

| Screw terminal (Plate clamp) socket | 96.72 | 96.72.0 | 96.74 | 96.74.0 |
|--|-----------------|--------------|---------------|--------------|
| panel or 35 mm rail (EN 60715) mount | Blue | Black | Blue | Black |
| For relay type | 56.32 | | 56.34 | |
| Accessories | | | | |
| Metal retaining clip (supplied with socket - packaging code SMA) | 094.71 | | 096.71 | |
| Modules (see table below) | | | 99.01 | |
| Technical data | | | | |
| Rated values | 12 A - 250 V | | | |
| Dielectric strength | 2 kV AC | | | |
| Protection category | IP 20 | | | |
| Ambient temperature | °C -40...+70 | | | |
| ⊕ Screw torque | Nm 0.8 | | | |
| Wire strip length | mm 10 | | | |
| Max. wire size for 96.72 and 96.74 sockets | solid wire | | stranded wire | |
| | mm ² | 1x4 / 2x4 | 1x4 / 2x2.5 | |
| | AWG | 1x12 / 2x12 | 1x12 / 2x14 | |

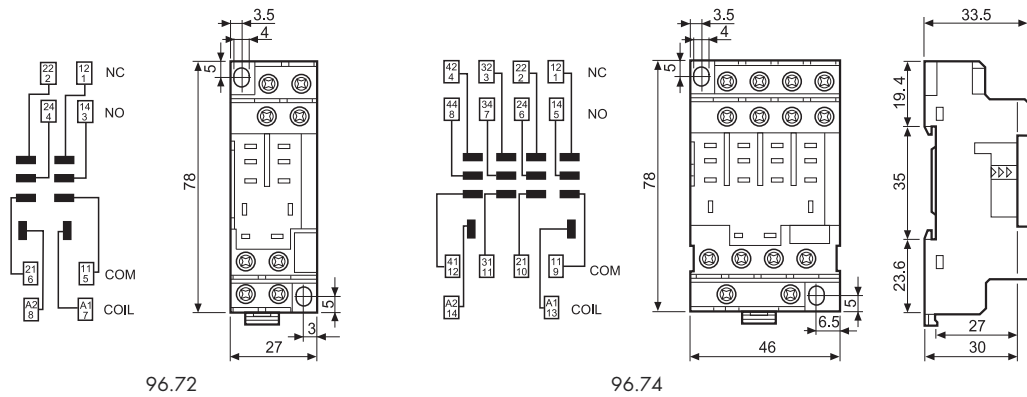

| 99.01 coil indication and EMC suppression modules for types 96.72 and 96.74 sockets | | Blue* |
|---|--------------------|----------------|
| Diode (+A1, standard polarity) | (6...220)V DC | 99.01.3.000.00 |
| Diode (+A2, non-standard polarity) | (6...220)V DC | 99.01.2.000.00 |
| LED | (6...24)V DC/AC | 99.01.0.024.59 |
| LED | (28...60)V DC/AC | 99.01.0.060.59 |
| LED | (110...240)V DC/AC | 99.01.0.230.59 |
| LED + Diode (+A1, standard polarity) | (6...24)V DC | 99.01.9.024.99 |
| LED + Diode (+A1, standard polarity) | (28...60)V DC | 99.01.9.060.99 |
| LED + Diode (+A1, standard polarity) | (110...220)V DC | 99.01.9.220.99 |
| LED + Diode (+A2, non-standard polarity) | (6...24)V DC | 99.01.9.024.79 |
| LED + Diode (+A2, non-standard polarity) | (28...60)V DC | 99.01.9.060.79 |
| LED + Diode (+A2, non-standard polarity) | (110...220)V DC | 99.01.9.220.79 |
| LED + Varistor | (6...24)V DC/AC | 99.01.0.024.98 |
| LED + Varistor | (28...60)V DC/AC | 99.01.0.060.98 |
| LED + Varistor | (110...240)V DC/AC | 99.01.0.230.98 |
| RC circuit | (6...24)V DC/AC | 99.01.0.024.09 |
| RC circuit | (28...60)V DC/AC | 99.01.0.060.09 |
| RC circuit | (110...240)V DC/AC | 99.01.0.230.09 |
| Residual current by-pass | (110...240)V AC | 99.01.8.230.07 |



96.12

Approvals
(according to type):



| PCB socket | 96.12 (blue) | 96.12.0 (black) | 96.14 (blue) | 96.14.0 (black) |
|--|--------------|-----------------|--------------|-----------------|
| For relay type | 56.32 | | 56.34 | |
| Accessories | | | | |
| Metal retaining clip (supplied with socket - packaging code SMA) | | | | 094.51 |
| Technical data | | | | |
| Rated values | 15 A - 250 V | | | |
| Dielectric strength | 2 kV AC | | | |
| Protection category | IP 20 | | | |
| Ambient temperature | °C -40...+70 | | | |

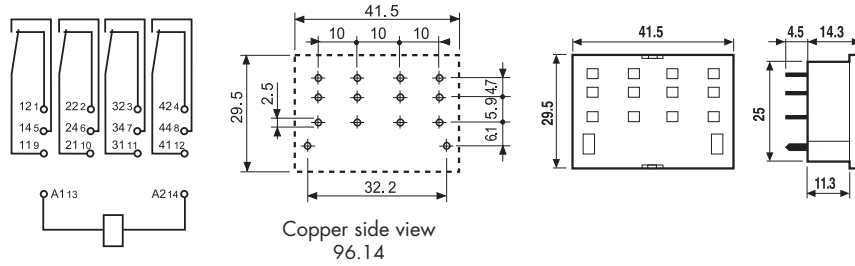
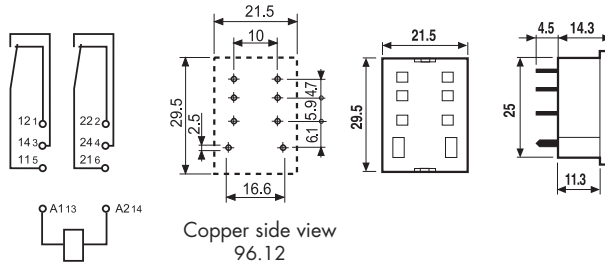

Packaging code

How to code and identify retaining clip and packaging options for sockets.

Example:

9 6 . 7 4 S M A

A Standard packaging

SM Metal retaining clip
SP Plastic retaining clip

9 6 . 7 4 [] []

Without retaining clip

X-ON Electronics

Largest Supplier of Electrical and Electronic Components

Click to view similar products for [Industrial Relays](#) category:

Click to view products by [Finder](#) manufacturer:

Other Similar products are found below :

[6-1618400-7](#) [686-117111](#) [686-120111](#) [EV250-4A-02](#) [EV250-6A-01](#) [FCA-125-CX8](#) [FCA-410-138](#) [8-1618393-1](#) [GCA32A208VAC60HZ](#)
[GCA32A220VAC50/60HZ](#) [GCA32A230VAC50/60HZ](#) [GCA32A240VAC50/60HZ](#) [GCA32A48VAC60HZ](#) [GCA63A120VAC50/60HZ](#)
[GCA63A208VAC60HZ](#) [GCA63A220VAC60HZ](#) [GCA63A230VAC50/60HZ](#) [GCA63A240VAC50/60HZ](#) [GCA63A277VAC60HZ](#)
[GCA63A48VAC60HZ](#) [GCA63A500VAC50/60HZ](#) [GCA63A600VAC60HZ](#) [GCA800A200VACDC](#) [GCA95A110VAC50/60HZ](#)
[GCA95A120VAC50/60HZ](#) [GCA95A12VDC](#) [GCA95A240VAC50/60HZ](#) [GCA95A24VAC50/60HZ](#) [GCA95A48VAC60HZ](#) [ACC530U20](#)
[ACC730U30](#) [1395832-1](#) [RM699BV-3011-85-1005](#) [RMIA210230AC](#) [RMIA45024AC](#) [1423675-8](#) [B07B032AC1-0329](#) [B329](#) [1617807-1](#)
[N417](#) [P25-E5019-1](#) [P30C42A12D1-120](#) [2-1618398-1](#) [PBO-18A1218](#) [2307497](#) [RPYA00324LT](#) [RPYA003A120LT](#) [KR-4539-1](#)
[RT334012WG](#) [S160156115](#)