



# IRC1 / IRC2 / IRC3 Instruction Manual

## 1. Product description

### 1.1 Product introduction:

- IRC1 is a simple remote control device which can be used with TS-700/1000/1500/3000 & TN-1500/3000. The built-in ON/OFF button allows remote ON/OFF of the inverter's output and power saving mode. The controller panel also shows inverter's working conditions such as Remote ON/OFF, abnormal, and power saving mode.
- IRC2 is a remote control device which can be used with TS-700/1000/1500/3000. Besides the control functions found in IRC1, it also has indications for battery capacity percentage and load percentage. This device is suitable for end users who need more information feedback from the inverter.
- IRC3 is a complete remote control device which can be used with TN-1500/3000 with solar charging function. The display found on the TN-1500/3000 unit is completely replicated onto the remote device. Besides the control functions found on IRC1/IRC2, IRC3 displays solar charging, AC charging, and whether the load is supplied by AC utility or inverter. Thus, allowing user to fully understand the solar inverter's current state.
- To satisfy different demands for remote control distances, the RC device can be matched with 3 types of cable length, 10ft cable (standard), or 25ft / 50ft (optional).

### 1.2 Product features:

- Push ON/OFF button can be used to turn the output of the inverter ON or OFF and setting the power saving function enable or disable.
- LED indications for inverter status.
- 2 installation methods. Mount on top of a vertical surface or inside system panel.
- 3 cable length available (10ft / 25ft / 50ft).
- Compliance to FCC / CE.
- 3 years warranty.

## 2. Diagram of device panel and explanation of operating status

### 2.1 IRC1 panel and explanation of LED indication:

LED indication	Green	Red	Orange	Orange Flash
Status description	Remote ON	Abnormal	Remote OFF	Power saving mode

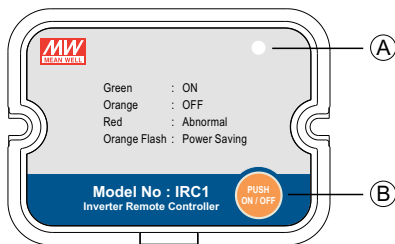

IRC1 panel

- Ⓐ : LED indicator
- Ⓑ : Push ON/OFF button

### 2.2 IRC2 panel and explanation of LED indication:

LED indication	Green	Red	Orange	Orange Flash
Status description	Remote ON	Abnormal	Remote OFF	Power saving mode

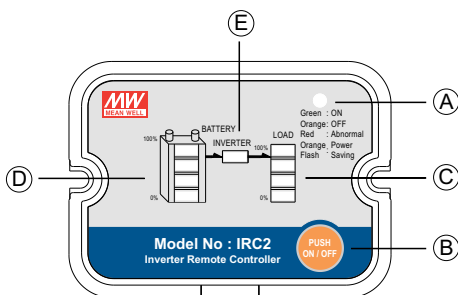

IRC2 panel

- Ⓐ : LED indicator
- Ⓑ : Push ON/OFF button
- Ⓒ : Load indicator
- Ⓓ : Battery capacity indicator
- Ⓔ : Inverter providing load

**2.2.1 Explanation of abnormal conditions:**

Load indicator	Status description	Load indicator	Status description
	Output OLP (>105%)		Output OLP (>115%)
	Output OLP (>150%)		OTP
	Abnormal output voltage level		Output short protection
	Battery input UVP/OVP		Battery fail protection (Battery aged)
	Fan lock protection		

**2.2.2 Explanation for Remote off:**

Load indicator	Status description
	Remote OFF

**2.2.3 Explanation of battery capacity level:**

BATTERY	<25%	25% ~ 50%	50% ~ 75%	BATTERY	>75%

**2.2.4 Explanation of load condition:**

LOAD	<25%	25% ~ 50%	50% ~ 75%	LOAD	>75%





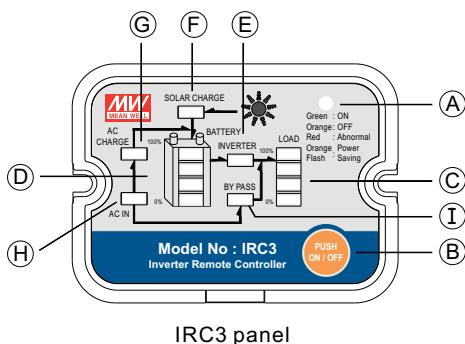



**2.3 IRC3 panel and explanation of LED indication:**

LED indication	Green	Red	Orange	Orange Flash
Status description	Remote ON	Abnormal	Remote OFF	Power saving mode



- Ⓐ : LED indicator
- Ⓑ : Push ON/OFF button
- Ⓒ : Load indicator
- Ⓓ : Battery capacity indicator
- Ⓔ : Inverter providing load
- Ⓕ : Solar charger ON/OFF
- Ⓖ : AC charger ON/OFF
- Ⓗ : AC utility normal
- Ⓘ : AC utility providing load





**2.3.1 Explanation of abnormal conditions:**

Load indicator	Status description	Load indicator	Status description
	Output OLP (>105%)		Output OLP (>115%)
	Output OLP (>150%)		OTP
	Abnormal output voltage level		Output short protection
	Battery input UVP/OVP		Battery fail protection (Battery aged)
	Fan lock protection		





**2.3.2 Explanation for Remote off:**

Load indicator	Status description
	Remote OFF





**2.3.3 Explanation of battery capacity level:**

	<25%		25% ↑ 50%		50% ↑ 75%		>75%
---	------	---	-----------------	---	-----------------	---	------

**2.3.4 Explanation of load condition:**

	<25%		25% ↑ 50%		50% ↑ 75%		>75%
---	------	---	-----------------	---	-----------------	---	------

**2.3.5 AC and solar charging status:**

	AC charger working		AC charger OFF
	Solar charger working		Solar charger OFF

**3. Operating instructions**

**3.1 Accessories:**

- a. IRC1/2/3 remote controller.
- b. RJ-11 ~ RJ-11 10ft (standard), 25ft / 50ft cable (optional).

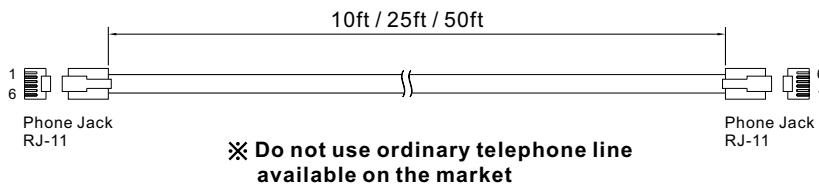

- c. Screw set (M4 combination of screw & washer + nuts x 2 sets).
- d. User's manual x 1.

**3.2 Installation method:**

(1) Mount on top of a vertical surface

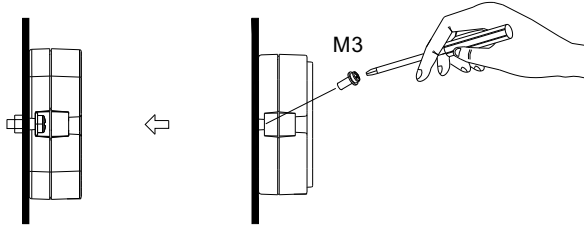

(2) Mount inside system panel

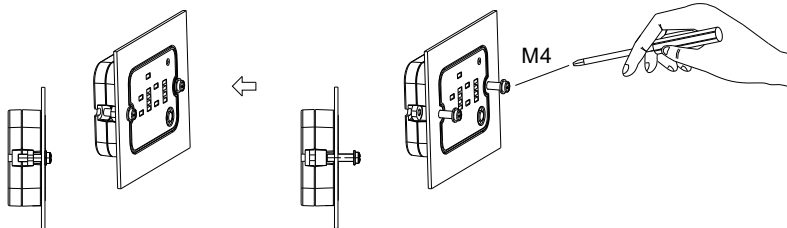

**3.3 Cable connection:**

Please use the provided cable when connecting the controller device to the jack found on the front panel of the inverter. Refer to the diagram below:

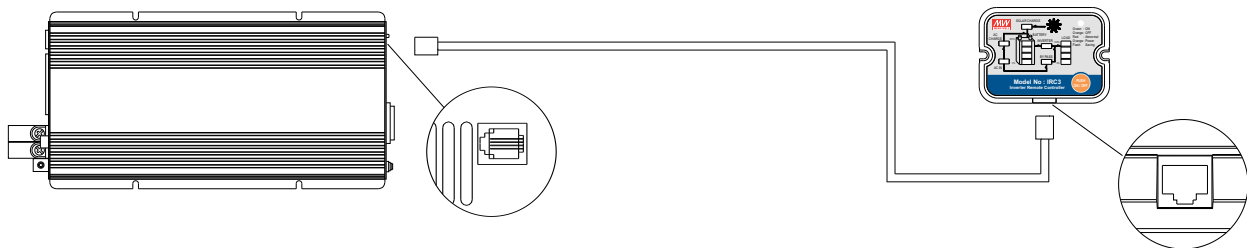

**3.4 Description of available functions:**

IRC1/2/3 can be used to remotely control inverter ON/OFF and enable or disable the power saving mode. After attaching the RJ11~RJ11 cable, all the LEDs on the device panel will light up, after waiting for about 5 seconds then the control process can begin. No external power source is required for the controller.

**3.4.1 Remotely control inverter ON/OFF:**

After pushing the ON/OFF setting button, the inverter will immediately shut down. The load indicator will also reflect this change in status. To restart the inverter, press the setting button again.

**3.4.2 Remotely enable or disable the power saving mode:**

This controller offers flexible adjustment of the standby mode, enable or disable. The operating sequence is as follows, press and hold on to the push ON/OFF button for about 3 seconds and the LED indicator will start flashing orange. Enter setting mode after letting go of the push ON/OFF button. Power saving mode can be enable or disable by pressing the push ON/OFF button. Check for setting status by inspection LED indication (refer to the chart below). After making your selection, hold on to the push ON/OFF button for 5 seconds and the LED indicator will flash orange, let go of the push ON/OFF button and the inverter will automatically restart to complete the setting sequence.

LED indicator	Green	Red
Status description	Enable power saving mode	Disable power saving mode

**4. Cautionary notes**

If the inverter goes into protection due to abnormal operating condition and cannot be restarted using the controller unit, please go on site to correct inverter failure condition and then resume remote operation.

## 5.Failure correction

Failure condition	Probable cause	Possible solution
LED indicator OFF	Improper wiring connection	Please use the provided cable accessory (Do not use ordinary telephone line)
	Loose wiring connection	Please make sure the connectors on the cables are attached securely to the jacks
	Inverter not ON	Please make sure the inverter is switched ON
Can not set power saving mode	Operational error	Please refer to 3.4.2 for more details
RC ON/OFF not operational	Inverter is abnormal	Check inverter status and clear abnormal condition

## 6.Warranty

- 6.1 Two years of free repair service is provided when the controller device is operated under normal operating conditions. Please do not change components or modify or repair the unit by yourself or else Mean Well reserves the right to void product warranty.**
- 6.2 This is a class A product. In a domestic environment this product may cause radio interference in which case the user may be required to take adequate measures.**

## X-ON Electronics

Largest Supplier of Electrical and Electronic Components

*Click to view similar products for [Power Inverters](#) category:*

*Click to view products by [Mean Well](#) manufacturer:*

Other Similar products are found below :

[PV-400FC](#) [PV550](#) [3SIP500012](#) [IPS-900 24V/230V](#) [SINUS600 24V](#) [PE-35](#) [PE-40](#) [PS-250](#) [3IPS100012](#) [TS-1500-224B](#) [ISI-500-148A](#) [TS-1000-224B](#) [TS400-124F](#) [TS200-112F](#) [TS400-224B](#) [TS-3000-112F](#) [TS200-224B](#) [TN-3000-124F](#) [TN-1500-248B](#) [IRC3\(10ft. Cable\)](#) [IPS-1000S 12V/230V ECO MODE](#) [IPS-1200S 24V/230V ECO MODE](#) [IPS-4000S 12V/230V ECO MODE](#) [IPS-800U 12V/230V](#) [3IPS030024](#) [3IPS40024](#) [3IPS050012](#) [SINUS-10000PRO 12V](#) [SINUS-850PRO 12V](#) [SINUSPRO-1000E](#) [3IPS100024](#) [3IPS500012](#) [3IPS500024](#) [3IPS651012](#) [3IPS651024](#) [3IPS912246](#) [3IPS912249](#) [RED-16 24/12V 16A](#) [RED-6 24/12V 6A](#) [DC-120 12/24V 4A](#) [DC PRO 200 24/12V 15A](#) [DC 200 24/12V 15A VER. 2](#) [DC PRO 400 24/12V 30A](#) [DC PRO 600 24/12V 45A](#) [3ZHP1LED34](#) [3ZHP1LED12](#) [3ZHP1LED24](#) [3SIP300012](#) [3SIP300024](#) [3SIP400012](#)