



Passive Components

Capacitors

Introduction

Tyco Electronics Ltd. is a leading global provider of engineered electronic components, network solutions, undersea telecommunication systems and wireless systems, with 2007 sales of \$13.0 billion to customers in more than 150 countries. We design, manufacture and market products for customers in industries from automotive, appliance and aerospace and defense to telecommunications, computers and consumer electronics. With over 7,000 engineers and worldwide manufacturing, sales and customer service capabilities, Tyco Electronics' commitment is our customers' advantage. More information on Tyco Electronics can be found at:

www.tycoelectronics.com

Tyco Electronics' product portfolio now includes a comprehensive range of passive components, including surface mount and leaded resistors, trimmers, potentiometers, PTC and NTC surface mount thermistors, as well as a wide range of inductive products covering wirewound, metal film surface mount, ceramic and ferrite bead.

A range of Capacitors, comprising SMD Multilayer Ceramic (MLCC) and Tantalum plus SMD, Radial, Axial and

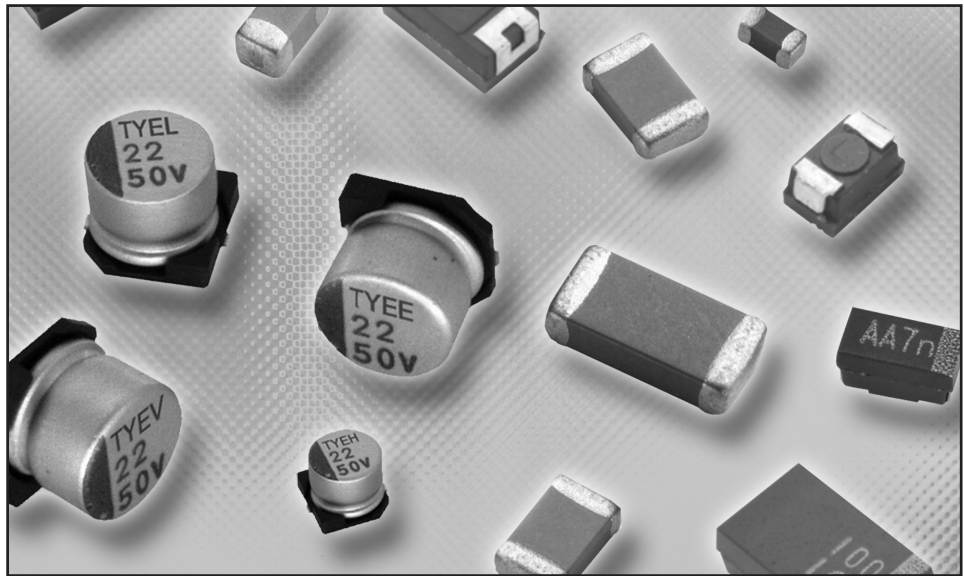

Snap-In Aluminium Electrolytic completes the Passive Components portfolio.

The range of Holsworthy precision resistors meets the requirement for economically priced components for both industrial and military applications. In SMD and leaded packages, with tolerances down to 0.05% and TCRs as low as 5ppm, the Holsworthy precision resistors range from Tyco Electronics delivers the "Complete Precision Portfolio".

For all trimming solutions, the Citec brand is the ideal design partner where your circuit requires sealed or unsealed trimmers from just 2mm square. Multiturns for

precision trimming are available with 11 or 12 turn setability. A prestigious range of Citec potentiometers, from single and multiturn versions with cermet or carbon elements, through to switched options with shafts in either plastic or metal is also offered.

Sigma noise suppression and protection inductor chips from Tyco Electronics can help protect circuits in a variety of ways.

The range offers solutions for high power, high speed, low frequency noise impedance as well as temperature responsive resistors in PTC and NTC. Sigma also encompasses a wide range of wound, multilayered and printed

inductors in addition to noise reduction bead inductors and through-hole RF chokes.

CGS high power and high voltage resistors are rated up to 100W with voltage proof to 50kV and are available in a wide variety of package styles. The CGS high power and pulse resistors range are capable of dissipating up to 25,000 Watts for applications such as regenerative braking and power supplies.

Neohm commodity resistors are available with SMD and Leaded devices. This wide range of products compliments and supports the Passives range available from the Tyco Electronics portfolio.

Contents

SMD Capacitors	Page
Tantalum	5
Multilayer Ceramic	25
Aluminium Electrolytic	35
Organic Conductive Polymer	49

Leaded Capacitors	Page
Radial Aluminium Electrolytic	52
Axial Aluminium Electrolytic	78
Snap-In Aluminium Electrolytic	91

Indexes	Page
Family Index	112
Tyco Electronics to Brand Part Number Index	113
Brand to Tyco Electronics Part Number Index	122

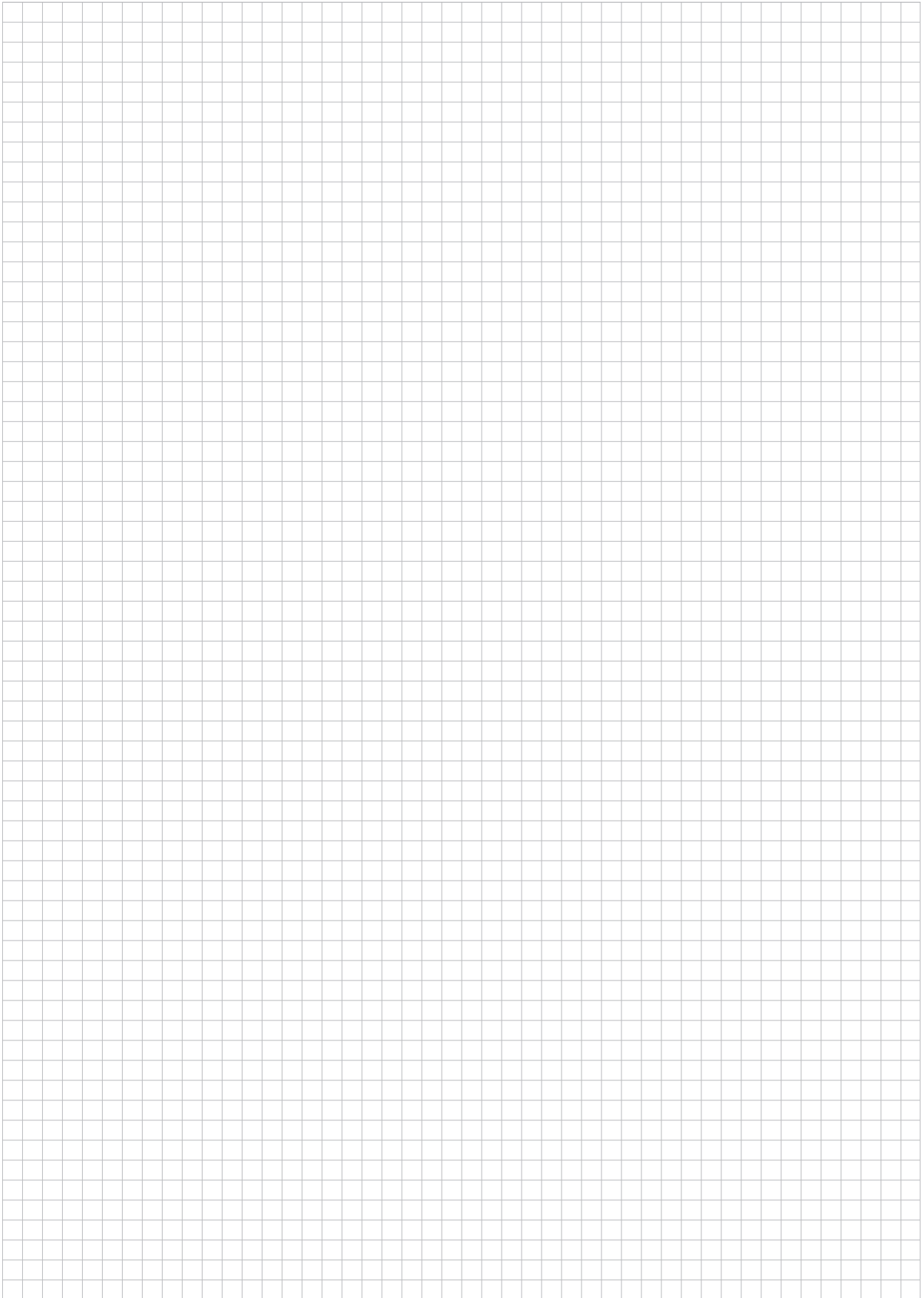

SMD Tantalum Capacitors - Product Overview

The TYT Range moulded solid Tantalum chip capacitors are designed for high solder heat resistance and ease of automatic placement.

The TYTS series is the standard type used throughout many industries and is complemented by the TYTM series which offers reduced cases sizes and extended value range.

The TYTP series provides further miniaturisation offering a wide range of values in a P (0805) case size.

The TYTR series offers a wide range of low ESR values

- Excellent frequency and impedance characteristics
- P(0805), A, B, C, D and E case sizes
- 2.5 to 50V ratings
- 10 or 20% tolerance options
- RoHS compliant

Case Size	Capacitance Range	Standard Tolerance	Voltage Range	Series	Page
A,B,C and D	0.68 to 68 μ F	\pm 10, 20%	4 to 50V	TYTS	6
A,B,C,D and E	0.1 to 470 μ F	\pm 10, 20%	2.5 to 50V	TYTM	9
P (0805)	0.1 to 10 μ F	\pm 10, 20%	2.5 to 20V	TYTP	15
P,A,B,C,D and E	0.1 to 470 μ F	\pm 10, 20%	4 to 50V	TYTR	18

Type TYTS Series

Type TYTS Series



The TYT series of moulded solid Tantalum chip capacitors is designed for high solder heat resistance and ease of automatic placement. The product is provided with both excellent frequency and impedance characteristics.

The four different product types cover the majority of requirements for this product series.

TYTS series is the standard type used in many industries and TYTM series extends this product range by applying advanced manufacturing technology, thereby allowing reduced sizes and extended value range.

TYTP series allows even further miniaturisation offering many values in an 0805 package size.

The series is completed with the TYTR series which offers a comprehensive range of low ESR products.

Key Features

- Excellent Frequency Characteristics
- Excellent Impedance Characteristics
- A, B, C & D Case Sizes
- 4V to 50V Ratings
- 10% or 20% Tolerance
- RoHS Compliant

Product Specifications

Product Specifications						Test Conditions JIS C5101-3(1998)		
Operating Temp. Range:		-55°C ~ +125°C						
Rated Voltage:		DC4 ~ 50V				85°C		
Surge Voltage:		DC5 ~ 65V				85°C		
Derated Voltage:		DC2.5 ~ 33V				125°C		
Capacitance:		0.1 ~ 68μF						
Capacitance Tolerance:		±10% or 20%				Measuring Frequency:120Hz ±10%, Measurement Circuit: Equivalent Series Circuit: Measuring Voltage Max.: 0.5Vrms,+1.5Vdc.		
Leakage Current:		0.01 CV or 0.5μA whichever is greater				Series Protective Resistor:1000Ω Measuring Voltage: Rated voltage Measuring Time: 5 minutes		
Surge Withstanding Voltage:		ΔC/C ±5% or less tanδ Specified initial value or less LC Specified initial value or less						
Temp. Characteristics:		Specified initial value	-55°C	+85°C	+125°C			
	ΔC/C	—	-10~0%	0~+10%	0~+12%	Step	Temp.°C	Duration
	tanδ Value shown table or less	0.04	<10V 12%	<10V 12%	<10V 15%	1	+25±2	—
		0.06	≥10V 15%	≥10V 15%	≥10V 15%	2	-55±2	30 min.
	LC	0.01CV or 0.5μA or less	—	0.1CV or 5μA or less	0.12CV or 6.0μA or less	3	+25±2	30 min.
				4	+85±2	30 min.		
				5	+125±2	30 min.		
				6	+25±2	—		
Solder Heat Resistance:		ΔC/C ±5% or less tanδ Specified initial value or less LC Specified initial value or less				Conditioning of Solder Dip: Solder Temperature: 260 ±5°C Dip Duration: 5±0.5s Depth of Immersion: Under Surface 10mm		
Moisture Resistance:		ΔC/C ±10% or less tanδ Specified initial value or less LC Specified initial value or less				40°C 90 ~ 95% RH, 56 Days		
High-Temperature Load:		ΔC/C ±10% or less tanδ Specified initial value or less LC 2 Times Specified initial value or less				85°C The rated voltage is applied for 2000 hours.		
Thermal Shock:		ΔC/C ±5% or less tanδ Specified initial value or less LC Specified initial value or less				Leave at -55°C, normal temperature, 125°C, and normal temperature for 30 min., 3 min., 30 min. and 3 min.. Repeat this operation 30 mins running		
Failure Rate:		1% / 2000h				85°C The rated voltage is applied (through a protective resistor of 1Ω/V).		

Product Availability Chart

Capacitance		Rated voltage (V.DC)							
		4.0	6.3	10	16	20	25	35	50
µF	Code								
0.10	104							A	A
0.15	154							A	B
0.22	224							A	B
0.33	334							A	B
0.47	474						A	B	C
0.68	684					A		B	C
1.0	105				A			B	C
1.5	155			A			B	C	D
2.2	225		A			B		C	D
3.3	335	A			B			C	
4.7	475			B			C	D	
6.8	685		B			C		D	
10	106	B			C		D		
15	156			C		D			
22	226			C	D				
33	336	C		D					
47	476		D						
68	686	D							

Standard Product Table

Rated Voltage V.DC	Capacitance		Case Code	DC Leakage Current mA*	Dissipation Factor (%)*	ESR (Ω)	Part Number**
	µF	Code					
4.0	3.3	335	A	0.5	6	9.0	TYTSA0G335(x)TRF
4.0	10	106	B	0.5	6	6.0	TYTSB0G106(x)TRF
4.0	33	336	C	1.3	6	2.2	TYTSC0G336(x)TRF
4.0	68	686	D	2.7	6	1.1	TYTSD0G686(x)TRF
6.3	2.2	225	A	0.5	6	9.0	TYTSA0J225(x)TRF
6.3	6.8	685	B	0.5	6	5.0	TYTSB0J685(x)TRF
6.3	22	226	C	1.39	6	1.8	TYTSC0J226(x)TRF
6.3	47	476	D	2.96	6	0.8	TYTSD0J476(x)TRF
10	1.5	155	A	0.5	6	10	TYTSA1A155(x)TRF
10	4.7	475	B	0.5	6	5.0	TYTSB1A475(x)TRF
10	15	156	C	1.5	6	2.2	TYTSC1A156(x)TRF
10	33	336	D	3.3	6	1.1	TYTSD1A336(x)TRF
16	1.0	105	A	0.5	4	11	TYTSA1C105(x)TRF
16	3.3	335	B	0.5	6	3.5	TYTSB1C335(x)TRF
16	10	106	C	1.6	6	2.0	TYTSC1C106(x)TRF
16	22	226	D	3.5	6	1.1	TYTSD1C226(x)TRF
20	0.68	684	A	0.5	4	12	TYTSA1D684(x)TRF
20	2.2	225	B	0.5	6	3.5	TYTSB1D225(x)TRF
20	6.8	685	C	1.4	6	2.0	TYTSC1D685(x)TRF
20	15	156	D	3.0	6	1.1	TYTSD1D156(x)TRF
25	0.47	474	A	0.5	4	14	TYTSA1E474(x)TRF
25	1.5	155	B	0.5	6	5.0	TYTSB1E155(x)TRF
25	4.7	475	C	1.2	6	2.4	TYTSC1E475(x)TRF
25	10	106	D	2.5	6	1.2	TYTSD1E106(x)TRF
35	0.1	104	A	0.5	4	24	TYTSA1V104(x)TRF
35	0.15	154	A	0.5	4	21	TYTSA1V154(x)TRF
35	0.22	224	A	0.5	4	18	TYTSA1V224(x)TRF
35	0.33	334	A	0.5	4	15	TYTSA1V334(x)TRF
35	0.47	474	B	0.5	4	10	TYTSB1V474(x)TRF
35	0.68	684	B	0.5	4	8.0	TYTSB1V684(x)TRF
35	1.0	105	B	0.5	4	6.5	TYTSB1V105(x)TRF
35	1.5	155	C	0.5	6	4.5	TYTSC1V155(x)TRF
35	2.2	225	C	0.8	6	3.5	TYTSC1V225(x)TRF
35	3.3	335	C	1.2	6	2.5	TYTSC1V335(x)TRF
35	4.7	475	D	1.6	6	1.5	TYTSD1V475(x)TRF

Standard Product Table (continued)

Rated Voltage V.DC	Capacitance		Case Code	DC Leakage Current mA*	Dissipation Factor (%)*	ESR (Ω)	Part Number**
	μF	Code					
35	6.8	685	D	2.4	6	1.3	TYTSD1V685(x)TRF
50	0.1	104	A	0.5	4	22	TYTSA1H104(x)TRF
50	0.15	154	B	0.5	4	17	TYTSB1H154(x)TRF
50	0.22	224	B	0.5	4	14	TYTSB1H224(x)TRF
50	0.33	334	B	0.5	4	12	TYTSB1H334(x)TRF
50	0.47	474	C	0.5	4	8.0	TYTSC1H474(x)TRF
50	0.68	684	C	0.5	4	7.0	TYTSC1H684(x)TRF
50	1.0	105	C	0.5	4	5.5	TYTSC1H105(x)TRF
50	1.5	155	D	0.8	6	4.0	TYTSD1H155(x)TRF
50	2.2	225	D	1.1	6	2.5	TYTSD1H225(x)TRF

*DCL and DF measured at 20°C

** (x) = tolerance where K = 10%, M = 20%

Dimensions

Anode (+) End View

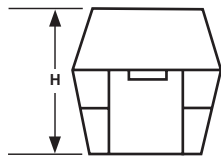

Side View

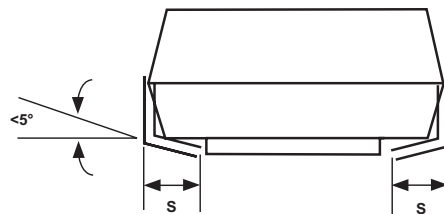

Cathode (-) End View

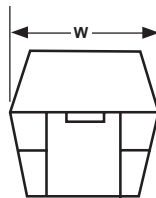

Bottom View

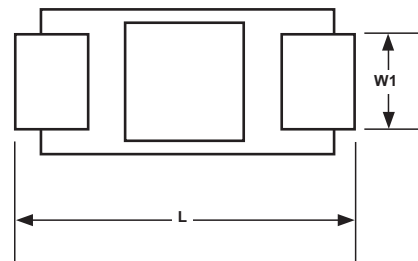

Case Code	L	W	Dimensions (mm)		W1
			H	S	
A	3.2±0.2	1.6±0.2	1.6±0.2	0.8±0.3	1.2±0.1
B	3.5±0.2	2.8±0.2	1.9±0.2	0.8±0.3	2.2±0.1
C	6.0±0.3	3.2±0.3	2.5±0.3	1.3±0.3	2.2±0.1
D	7.3±0.3	4.3±0.3	2.8±0.3	1.3±0.3	2.4±0.1

How to Order

TYTS	A	0G	105	K	TRF
Series	Case Code	Voltage Code	Capacitance	Tolerance	Packaging
TYTS	A, B, C or D	0G (4.0V) 0J (6.3V) 1A (10V) 1C (16V) 1D (20V) 1E (25V) 1V (35V) 1H (50V)	eg. 105	K (10%) M (20%)	TRF = 7" Reels (A and B Case 2000) (C and D Case 500)

Type TYTM Series

Type TYTM Series

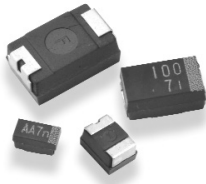

The TYT series of moulded solid Tantalum chip capacitors is designed for high solder heat resistance and ease of automatic placement. The product is provided with both excellent frequency and impedance characteristics.

The four different product types cover the majority of requirements for this product series.

TYTS series is the standard type used in many industries and TYTM series extends this product range by applying advanced manufacturing technology, thereby allowing reduced sizes and extended value range.

TYTP series allows even further miniaturisation offering many values in an 0805 package size.

The series is completed with the TYTR series which offers a comprehensive range of low ESR products.

Key Features

- Excellent Frequency Characteristics
- Excellent Impedance Characteristics
- Super Compact Size
- A, B, C, D & E Case Sizes
- 2.5V to 50V Ratings
- 10% or 20% Tolerance
- RoHS Compliant

Product Specifications

Product Specifications						Test Conditions JIS C5101-3(1998)		
Operating Temp. Range:		-55°C ~ +125°C						
Rated Voltage:		DC2.5 ~ 50V				85°C		
Surge Voltage:		DC3.2 ~ 65V				85°C		
Derated Voltage:		DC1.6 ~ 33V				125°C		
Capacitance:		0.1 ~ 470µF						
Capacitance Tolerance:		±10% or 20%				Measuring Frequency: 120Hz ±10%, Measurement Circuit: Equivalent Series Circuit: Measuring voltage max.: 0.5Vrms, +1.5Vdc.		
Leakage Current:		Refer to standard product table				Series Protective Resistor: 1000Ω Measuring Voltage: Rated voltage Measuring Time: 5 minutes		
Surge Withstanding Voltage:		$\Delta C/C$ ±5% or less $\tan\theta$ Specified initial value or less LC Specified initial value or less						
Temp. Characteristics:		Specified initial value	-55°C	+85°C	+125°C			
	$\Delta C/C$	—	-10~0%	0~+10%	0~+12%	Step	Temp. °C	Duration
	$\tan\theta$ Value shown table or less	0.04	<10V 12%	<10V 12%	<10V 15%	1	+25±2	—
		0.06	≥10V 15%	≥10V 15%	≥10V 15%	2	-55±2	30 min.
		0.08				3	+25±2	30 min.
	LC	0.01CV or 0.5µA or less	—	0.1CV or 5µA or less	0.12CV or 6.0µA or less	4	+85±2	30 min.
						5	+125±2	30 min.
						6	+25±2	—
Solder Heat Resistance:		$\Delta C/C$ ±5% or less $\tan\theta$ Specified initial value or less LC Specified initial value or less				Conditioning of Solder Dip: Solder Temperature: 260 ±5°C Dip Duration: 5±0.5s Depth of Immersion: Under Surface 10mm		
Moisture Resistance:		$\Delta C/C$ ±10% or less $\tan\theta$ Specified initial value or less LC Specified initial value or less				40°C 90 ~ 95% RH, 56 Days		
High-Temperature Load:		$\Delta C/C$ ±10% or less $\tan\theta$ Specified initial value or less LC 125% Specified initial value or less				85°C The rated voltage is applied for 2000 hours.		
Thermal Shock:		$\Delta C/C$ ±10% or less $\tan\theta$ Specified initial value or less LC Specified initial value or less				Leave at -55°C, normal temperature, 125°C, and normal temperature for 30 min., 3 min., 30 min. and 3 min.. Repeat this operation 30 mins running		
Moisture Resistance Load:		$\Delta C/C$ ±10% or less $\tan\theta$ 150% Specified initial value or less LC 200% Specified initial value or less				40°C, humidity 90 to 95% RH The rated voltage is applied for 500 hours.		
Failure Rate:		1% / 2000h				85°C The rated voltage is applied (through a protective resistor of 1Ω/V).		

Product Availability Chart

Capacitance		Rated voltage (V.DC)								
		2.5	4.0	6.3	10	16	20	25	35	50
µF	Code									
0.1	104								A	A
0.15	154								A	A,B
0.22	224								A	B
0.33	334								A	B
0.47	474							A	A,B	B,C
0.68	684						A	A	A	B,C
1.0	105			A	A	A	A	A	A,B	C
1.5	155			A	A	A	A,B	A,B	B,C	C,D
2.2	225			A	A	A	A,B	B	B,C	C,D,E
3.3	335		A	A	A	A,B	A,B	B	B,C,D	D
4.7	475		A	A	A	A,B	A,B	B,C	C,D	D
6.8	685	A	A	A	A,B	A,B	B,C	C	C,D	D,E
10	106	A	A	A,B	A,B	A,B,C	B,C	C,D	C,D	E
15	156	A	A,B	A,B	A,B,C	B,C	C	C,D	D,E	
22	226	A	A,B	A,B	B,C	B,C,D	C,D	D	D,E	
33	336	B	B,C	B,C	B,C,D	C,D	C,D	D,E		
47	476	B	B,C	B,C	B,C,D	C,D	D	D,E		
68	686	B,C	B,C	B,C,D	C,D	D				
100	107	B,C	B,C,D	B,C,D	C,D	D,E				
150	157	C,D	C,D	C,D	D,E	E				
220	227	C,D	C,D	D	D					
330	337	D	D	D						
470	477	D	D							

Standard Product Table

Rated Voltage V.DC	Capacitance		Case Code	DC Leakage Current mA*	Dissipation Factor (%)*	ESR (Ω)	Part Number**
	µF	Code					
2.5	6.8	685	A	0.5	6	6.5	TYTMA0E685(x)TRF
2.5	10	106	A	0.5	6	6.0	TYTMA0E106(x)TRF
2.5	15	156	A	0.5	6	4.0	TYTMA0E156(x)TRF
2.5	22	226	A	0.6	6	3.2	TYTMA0E226(x)TRF
2.5	22	226	B	0.6	6	2.5	TYTMB0E226(x)TRF
2.5	33	336	B	0.8	6	2.8	TYTMB0E336(x)TRF
2.5	47	476	B	1.2	6	1.8	TYTMB0E476(x)TRF
2.5	68	686	B	1.7	6	2.5	TYTMB0E686(x)TRF
2.5	68	686	C	1.7	6	1.6	TYTMC0E686(x)TRF
2.5	100	107	B	2.5	8	2.5	TYTMB0E107(x)TRF
2.5	100	107	C	2.5	8	1.3	TYTMC0E107(x)TRF
2.5	150	157	C	3.8	8	1.2	TYTMC0E157(x)TRF
2.5	150	157	D	3.8	8	0.9	TYTMD0E157(x)TRF
2.5	220	227	C	5.5	8	1.2	TYTMC0E227(x)TRF
2.5	220	227	D	5.5	8	0.9	TYTMD0E227(x)TRF
2.5	330	337	D	8.3	8	0.9	TYTMD0E337(x)TRF
2.5	470	477	D	11.8	8	0.9	TYTMD0E477(x)TRF
4.0	3.3	335	A	0.5	6	9.0	TYTMA0G335(x)TRF
4.0	4.7	475	A	0.5	6	7.5	TYTMA0G475(x)TRF
4.0	6.8	685	A	0.5	6	6.5	TYTMA0G685(x)TRF
4.0	10	106	A	0.5	6	6.0	TYTMA0G106(x)TRF
4.0	15	156	A	0.6	6	4.0	TYTMA0G156(x)TRF
4.0	15	156	B	0.6	6	3.5	TYTMB0G156(x)TRF
4.0	22	226	A	0.9	6	3.5	TYTMA0G226(x)TRF
4.0	22	226	B	0.9	6	3.2	TYTMB0G226(x)TRF
4.0	33	336	B	1.3	6	2.8	TYTMB0G336(x)TRF
4.0	33	336	C	1.3	6	2.2	TYTMC0G336(x)TRF
4.0	47	476	B	1.9	6	2.2	TYTMB0G476(x)TRF
4.0	47	476	C	1.9	6	1.8	TYTMC0G476(x)TRF
4.0	68	686	B	2.7	6	3.5	TYTMB0G686(x)TRF
4.0	68	686	C	2.7	6	1.6	TYTMC0G686(x)TRF
4.0	100	107	B	4.0	8	2.5	TYTMB0G107(x)TRF

Type TYTM Series

Standard Product Table (continued)

Rated Voltage V.DC	Capacitance		Case Code	DC Leakage Current mA*	Dissipation Factor (%)*	ESR (Ω)	Part Number**
	μF	Code					
4.0	100	107	C	4.0	8	1.3	TYTMC0G107(x)TRF
4.0	100	107	D	4.0	8	0.9	TYTMD0G107(x)TRF
4.0	150	157	C	6.0	8	0.9	TYTMC0G157(x)TRF
4.0	150	157	D	6.0	8	0.9	TYTMD0G157(x)TRF
4.0	220	227	C	8.8	8	1.2	TYTMC0G227(x)TRF
4.0	220	227	D	8.8	8	0.9	TYTMD0G227(x)TRF
4.0	330	337	D	13.2	8	0.9	TYTMD0G337(x)TRF
4.0	470	477	D	18.8	8	0.9	TYTMD0G477(x)TRF
6.3	1.0	105	A	0.5	4	14	TYTMA0J105(x)TRF
6.3	1.5	155	A	0.5	6	12	TYTMA0J155(x)TRF
6.3	2.2	225	A	0.5	6	9.0	TYTMA0J225(x)TRF
6.3	3.3	335	A	0.5	6	7.0	TYTMA0J335(x)TRF
6.3	4.7	475	A	0.5	6	6.0	TYTMA0J475(x)TRF
6.3	6.8	685	A	0.5	6	5.0	TYTMA0J685(x)TRF
6.3	10	106	A	0.6	6	4.0	TYTMA0J106(x)TRF
6.3	10	106	B	0.6	6	3.0	TYTMB0J106(x)TRF
6.3	15	156	A	0.9	6	4.0	TYTMA0J156(x)TRF
6.3	15	156	B	0.9	6	3.3	TYTMB0J156(x)TRF
6.3	22	226	A	1.4	6	3.5	TYTMA0J226(x)TRF
6.3	22	226	B	1.4	6	2.5	TYTMB0J226(x)TRF
6.3	33	336	B	2.1	6	2.0	TYTMB0J336(x)TRF
6.3	33	336	C	2.1	6	1.8	TYTMC0J336(x)TRF
6.3	47	476	B	3.0	6	2.0	TYTMB0J476(x)TRF
6.3	47	476	C	3.0	6	1.6	TYTMC0J476(x)TRF
6.3	68	686	B	4.3	6	1.0	TYTMB0J686(x)TRF
6.3	68	686	C	4.3	6	1.6	TYTMC0J686(x)TRF
6.3	68	686	D	4.3	6	0.9	TYTMD0J686(x)TRF
6.3	100	107	B	6.3	8	1.4	TYTMB0J107(x)TRF
6.3	100	107	C	6.3	8	1.4	TYTMC0J107(x)TRF
6.3	100	107	D	6.3	8	0.9	TYTMD0J107(x)TRF
6.3	150	157	C	9.5	8	1.2	TYTMC0J157(x)TRF
6.3	150	157	D	9.5	8	0.9	TYTMD0J157(x)TRF
6.3	220	227	D	13.9	8	0.7	TYTMD0J227(x)TRF
6.3	330	337	D	20.8	8	0.5	TYTMD0J337(x)TRF
10	1.0	105	A	0.5	4	13	TYTMA1A105(x)TRF
10	1.5	155	A	0.5	6	10	TYTMA1A155(x)TRF
10	2.2	225	A	0.5	6	7.0	TYTMA1A225(x)TRF
10	3.3	335	A	0.5	6	5.5	TYTMA1A335(x)TRF
10	4.7	475	A	0.5	6	5.0	TYTMA1A475(x)TRF
10	6.8	685	A	0.7	6	4.0	TYTMA1A685(x)TRF
10	6.8	685	B	0.7	6	3.0	TYTMB1A685(x)TRF
10	10	106	A	1.0	6	3.0	TYTMA1A106(x)TRF
10	10	106	B	1.0	6	2.5	TYTMB1A106(x)TRF
10	15	156	A	1.5	6	6.0	TYTMA1A156(x)TRF
10	15	156	B	1.5	6	2.8	TYTMB1A156(x)TRF
10	15	156	C	1.5	6	2.2	TYTMC1A156(x)TRF
10	22	226	B	2.2	6	2.4	TYTMB1A226(x)TRF
10	22	226	C	2.2	6	1.8	TYTMC1A226(x)TRF
10	33	336	B	3.3	6	1.6	TYTMB1A336(x)TRF
10	33	336	C	3.3	6	1.6	TYTMC1A336(x)TRF
10	33	336	D	3.3	6	1.1	TYTMD1A336(x)TRF
10	47	476	B	4.7	6	1.0	TYTMB1A476(x)TRF
10	47	476	C	4.7	6	1.2	TYTMC1A476(x)TRF
10	47	476	D	4.7	6	0.9	TYTMD1A476(x)TRF
10	68	686	C	6.8	6	1.2	TYTMC1A686(x)TRF
10	68	686	D	6.8	6	0.9	TYTMD1A686(x)TRF
10	100	107	C	10	8	1.3	TYTMC1A107(x)TRF
10	100	107	D	10	8	0.9	TYTMD1A107(x)TRF
10	150	157	D	15	8	0.7	TYTMD1A157(x)TRF
10	150	157	E	15	8	0.9	TYTME1A157(x)TRF
10	220	227	D	22	8	0.5	TYTMD1A227(x)TRF

Type TYTM Series

Standard Product Table (continued)

Rated Voltage V.DC	Capacitance		Case Code	DC Leakage Current mA*	Dissipation Factor (%)*	ESR (Ω)	Part Number**
	μF	Code					
16	1.0	105	A	0.5	4	11	TYTMA1C105(x)TRF
16	1.5	155	A	0.5	6	8.0	TYTMA1C155(x)TRF
16	2.2	225	A	0.5	6	6.5	TYTMA1C225(x)TRF
16	3.3	335	A	0.5	6	6.0	TYTMA1C335(x)TRF
16	3.3	335	B	0.5	6	5.0	TYTMB1C335(x)TRF
16	4.7	475	A	0.8	6	4.0	TYTMA1C475(x)TRF
16	4.7	475	B	0.8	6	3.5	TYTMB1C475(x)TRF
16	6.8	685	A	1.1	6	5.0	TYTMA1C685(x)TRF
16	6.8	685	B	1.1	6	3.5	TYTMB1C685(x)TRF
16	10	106	A	1.6	6	5.0	TYTMA1C106(x)TRF
16	10	106	B	1.6	6	2.8	TYTMB1C106(x)TRF
16	10	106	C	1.6	6	2.0	TYTMC1C106(x)TRF
16	15	156	B	2.4	6	3.0	TYTMB1C156(x)TRF
16	15	156	C	2.4	6	1.8	TYTMC1C156(x)TRF
16	22	226	B	3.5	6	2.2	TYTMB1C226(x)TRF
16	22	226	C	3.5	6	1.6	TYTMC1C226(x)TRF
16	22	226	D	3.5	6	1.1	TYTMD1C226(x)TRF
16	33	336	C	5.3	6	1.5	TYTMC1C336(x)TRF
16	33	336	D	5.3	6	0.9	TYTMD1C336(x)TRF
16	47	476	C	7.5	6	1.4	TYTMC1C476(x)TRF
16	47	476	D	7.5	6	0.9	TYTMD1C476(x)TRF
16	68	686	D	10.9	6	0.9	TYTMD1C686(x)TRF
16	100	107	D	16	8	0.9	TYTMD1C107(x)TRF
16	100	107	E	16	8	0.9	TYTME1C107(x)TRF
16	150	157	E	24	8	0.9	TYTME1C157(x)TRF
20	0.68	684	A	0.5	4	12	TYTMA1D684(x)TRF
20	1.0	105	A	0.5	4	9.0	TYTMA1D105(x)TRF
20	1.5	155	A	0.5	6	6.5	TYTMA1D155(x)TRF
20	1.5	155	B	0.5	6	5.0	TYTMB1D155(x)TRF
20	2.2	225	A	0.5	6	5.3	TYTMA1D225(x)TRF
20	2.2	225	B	0.5	6	3.5	TYTMB1D225(x)TRF
20	3.3	335	A	0.7	6	7.0	TYTMA1D335(x)TRF
20	3.3	335	B	0.7	6	3.0	TYTMB1D335(x)TRF
20	4.7	475	A	0.9	6	6.0	TYTMA1D475(x)TRF
20	4.7	475	B	0.9	6	3.0	TYTMB1D475(x)TRF
20	6.8	685	B	1.4	6	3.5	TYTMB1D685(x)TRF
20	6.8	685	C	1.4	6	2.0	TYTMC1D685(x)TRF
20	10	106	B	2.0	6	3.0	TYTMB1D106(x)TRF
20	10	106	C	2.0	6	1.8	TYTMC1D106(x)TRF
20	15	156	C	3.0	6	1.7	TYTMC1D156(x)TRF
20	22	226	C	4.4	6	0.9	TYTMC1D226(x)TRF
20	22	226	D	4.4	6	0.9	TYTMD1D226(x)TRF
20	33	336	C	6.6	6	0.9	TYTMC1D336(x)TRF
20	33	336	D	6.6	6	0.9	TYTMD1D336(x)TRF
20	33	336	E	6.6	6	0.9	TYTME1D336(x)TRF
20	47	476	D	9.4	6	0.7	TYTMD1D476(x)TRF
20	47	476	E	9.4	6	0.9	TYTME1D476(x)TRF
25	0.47	474	A	0.5	4	14	TYTMA1E474(x)TRF
25	0.68	684	A	0.5	4	10	TYTMA1E684(x)TRF
25	1.0	105	A	0.5	4	8.0	TYTMA1E105(x)TRF
25	1.5	155	A	0.5	6	10	TYTMA1E155(x)TRF
25	1.5	155	B	0.5	6	5.0	TYTMB1E155(x)TRF
25	2.2	225	B	0.6	6	4.5	TYTMB1E225(x)TRF
25	3.3	335	B	0.8	6	4.0	TYTMB1E335(x)TRF
25	4.7	475	B	1.2	6	3.5	TYTMB1E475(x)TRF
25	4.7	475	C	1.2	6	2.4	TYTMC1E475(x)TRF
25	6.8	685	C	1.7	6	2.0	TYTMC1E685(x)TRF
25	10	106	C	2.5	6	1.8	TYTMC1E106(x)TRF
25	10	106	D	2.5	6	1.2	TYTMD1E106(x)TRF
25	15	156	C	3.8	6	1.2	TYTMC1E156(x)TRF
25	15	156	D	3.8	6	1.0	TYTMD1E156(x)TRF
25	22	226	D	5.5	6	0.9	TYTMD1E226(x)TRF
25	33	336	D	8.3	6	0.7	TYTMD1E336(x)TRF
25	33	336	E	8.3	6	0.9	TYTME1E336(x)TRF

Type TYTM Series

Standard Product Table (continued)

Rated Voltage V.DC	Capacitance		Case Code	DC Leakage Current mA*	Dissipation Factor (%)*	ESR (Ω)	Part Number**
	μF	Code					
25	47	476	D	11.8	6	0.7	TYTMD1E476(x)TRF
25	47	476	E	11.8	6	0.9	TYTME1E476(x)TRF
35	0.1	104	A	0.5	4	24	TYTMA1V104(x)TRF
35	0.15	154	A	0.5	4	21	TYTMA1V154(x)TRF
35	0.22	224	A	0.5	4	18	TYTMA1V224(x)TRF
35	0.33	334	A	0.5	4	15	TYTMA1V334(x)TRF
35	0.47	474	A	0.5	4	12	TYTMA1V474(x)TRF
35	0.47	474	B	0.5	4	10	TYTMB1V474(x)TRF
35	0.68	684	A	0.5	4	10	TYTMA1V684(x)TRF
35	1.0	105	A	0.5	4	10	TYTMA1V105(x)TRF
35	1.0	105	B	0.5	4	6.5	TYTMB1V105(x)TRF
35	1.5	155	B	0.5	6	5.2	TYTMB1V155(x)TRF
35	1.5	155	C	0.5	6	4.5	TYTMC1V155(x)TRF
35	2.2	225	B	0.8	6	4.0	TYTMB1V225(x)TRF
35	2.2	225	C	0.8	6	3.5	TYTMC1V225(x)TRF
35	3.3	335	B	1.2	6	3.0	TYTMB1V335(x)TRF
35	3.3	335	C	1.2	6	2.5	TYTMC1V335(x)TRF
35	3.3	335	D	1.2	6	2.0	TYTMD1V335(x)TRF
35	4.7	475	C	1.6	6	2.2	TYTMC1V475(x)TRF
35	4.7	475	D	1.6	6	1.5	TYTMD1V475(x)TRF
35	6.8	685	C	2.4	6	2.0	TYTMC1V685(x)TRF
35	6.8	685	D	2.4	6	1.3	TYTMD1V685(x)TRF
35	10	106	C	3.5	6	1.2	TYTMC1V106(x)TRF
35	10	106	D	3.5	6	1.0	TYTMD1V106(x)TRF
35	15	156	D	5.3	6	0.8	TYTMD1V156(x)TRF
35	15	156	E	5.3	6	0.9	TYTME1V156(x)TRF
35	22	226	D	7.7	6	0.7	TYTMD1V226(x)TRF
35	22	226	E	7.7	6	0.9	TYTME1V226(x)TRF
50	0.1	104	A	0.5	4	22	TYTMA1H104(x)TRF
50	0.15	154	A	0.5	4	17	TYTMA1H154(x)TRF
50	0.15	154	B	0.5	4	15	TYTMB1H154(x)TRF
50	0.22	224	B	0.5	4	14	TYTMB1H224(x)TRF
50	0.33	334	B	0.5	4	12	TYTMB1H334(x)TRF
50	0.47	474	B	0.5	4	9.0	TYTMB1H474(x)TRF
50	0.47	474	C	0.5	4	8.0	TYTMC1H474(x)TRF
50	0.68	684	B	0.5	4	8.0	TYTMB1H684(x)TRF
50	0.68	684	C	0.5	4	7.0	TYTMC1H684(x)TRF
50	1.0	105	C	0.5	4	5.5	TYTMC1H105(x)TRF
50	1.5	155	C	0.8	6	4.5	TYTMC1H155(x)TRF
50	1.5	155	D	0.8	6	4.0	TYTMD1H155(x)TRF
50	2.2	225	C	1.1	6	3.5	TYTMC1H225(x)TRF
50	2.2	225	D	1.1	6	2.5	TYTMD1H225(x)TRF
50	2.2	225	E	1.1	6	2.5	TYTME1H225(x)TRF
50	3.3	335	D	1.7	6	2.0	TYTMD1H335(x)TRF
50	4.7	475	D	2.4	6	1.5	TYTMD1H475(x)TRF
50	6.8	685	D	3.4	6	0.9	TYTMD1H685(x)TRF
50	6.8	685	E	3.4	6	0.9	TYTME1H685(x)TRF
50	10	106	E	5.0	6	0.8	TYTME1H106(x)TRF

*DCL and DF measured at 20°C

** (x) = tolerance where K = 10%, M = 20%

Dimensions

Anode (+) End View

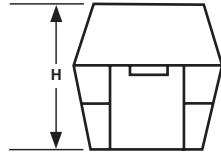

Side View

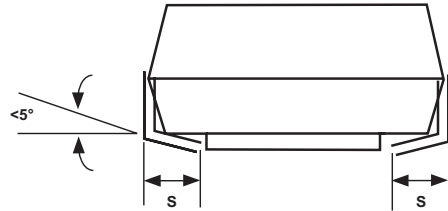

Cathode (-) End View

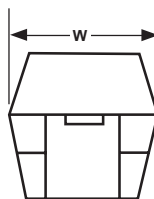

Bottom View

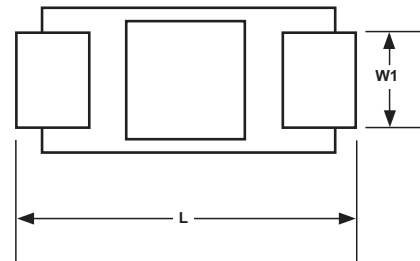

Case Code	L	W	Dimensions (mm)		
			H	S	W1
A	3.2±0.2	1.6±0.2	1.6±0.2	0.8±0.3	1.2±0.1
B	3.5±0.2	2.8±0.2	1.9±0.2	0.8±0.3	2.2±0.1
C	6.0±0.2	3.2±0.2	2.5±0.2	1.3±0.2	2.2±0.0
D	7.3±0.2	4.3±0.2	2.8±0.2	1.3±0.2	2.4±0.0
E	7.3±0.3	4.3±0.3	4.0±0.3	1.3±0.3	2.4±0.1

How to Order

TYTM	A	0E	105	K	TRF
Series	Case Code	Voltage Code	Capacitance	Tolerance	Packaging
TYTM	A, B, C, D or E	0E (2.5V) 0G (4.0V) 0J (6.3V) 1A (10V) 1C (16V) 1D (20V) 1E (25V) 1V (35V) 1H (50V)	eg. 105	K (10%) M (20%)	TRF = 7" Reels (A and B Case 2000) (C, D & E Case 500)

Type TYTP Series

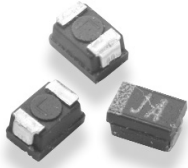

The TYT series of moulded solid Tantalum chip capacitors is designed for high solder heat resistance and ease of automatic placement. The product is provided with both excellent frequency and impedance characteristics.

The four different product types cover the majority of requirements for this product series.

TYTS series is the standard type used in many industries and TYTM series extends this product range by applying advanced manufacturing technology, thereby allowing reduced sizes and extended value range.

TYTP series allows even further miniaturisation offering many values in an 0805 package size.

The series is completed with the TYTR series which offers a comprehensive range of low ESR products.

Key Features

- Excellent Frequency Characteristics
- Excellent Impedance Characteristics
- Super Compact Size
- Suitable for High Density Packaging
- 2.5V to 20V Ratings
- 10% or 20% Tolerance
- RoHS Compliant

Product Specifications

Product Specifications						Test Conditions JIS C5101-3(1998)		
Operating Temp. Range:		-55°C ~ +125°C						
Rated Voltage:		DC2.5 ~ 20V				85°C		
Surge Voltage:		DC3.2 ~ 26V				85°C		
Derated Voltage:		DC1.6 ~ 13V				125°C		
Capacitance:		0.1 ~ 10µF						
Capacitance Tolerance:		±10% or 20%				Measuring Frequency:120Hz ±10%, Measurement Circuit: Equivalent Series Circuit: Measuring Voltage Max.: 0.5Vrms,+1.5Vdc.		
Leakage Current:		Refer to standard product table				Series Protective Resistor:1000Ω Measuring Voltage: Rated voltage Measuring Time: 5 minutes		
Surge Withstanding Voltage:		$\Delta C/C$ ±10% or less $\tan\delta$ Specified initial value or less LC Specified initial value or less						
Temp. Characteristics:		Specified initial value	-55°C	+85°C	+125°C			
	$\Delta C/C$	—	-12-0%	0~+10%	0~+12%	Step	Temp.°C	Duration
	$\tan\delta$ Value shown table or less	0.04	<10V 12%	<10V 12%	<10V 15%	1	+25±2	—
		0.06	≥10V 15%	≥10V 15%	≥10V 15%	2	-55±2	30 min.
	LC	0.01CV or 0.5µA or less	—	0.1CV or 5µA or less	0.12CV or 6.0µA or less	3	+25±2	30 min.
						4	+85±2	30 min.
						5	+125±2	30 min.
						6	+25±2	—
Solder Heat Resistance:		$\Delta C/C$ ±5% or less $\tan\delta$ Specified initial value or less LC Specified initial value or less				Conditioning of Solder Dip: Solder Temperature: 260 ±5°C Dip Duration: 5±0.5s Depth of Immersion: Under Surface 10mm		
Moisture Resistance:		$\Delta C/C$ ±10% or less $\tan\delta$ Specified initial value or less LC Specified initial value or less				40°C 90 ~ 95% RH, 56 Days		
High-Temperature Load:		$\Delta C/C$ ±10% or less $\tan\delta$ Specified initial value or less LC 125% Specified initial value or less				85°C The rated voltage is applied for 2000 hours.		
Thermal Shock:		$\Delta C/C$ ±10% or less $\tan\delta$ Specified initial value or less LC Specified initial value or less				Leave at -55°C, normal temperature, 125°C, and normal temperature for 30 min., 3 min., 30 min. and 3 min.. Repeat this operation 30 mins running		
Moisture Resistance Load:		$\Delta C/C$ ±10% or less $\tan\delta$ 150% Specified initial value or less LC 200% Specified initial value or less				40°C, humidity 90 to 95% RH The rated voltage is applied for 500 hours.		
Failure Rate:		1% / 2000h				85°C The rated voltage is applied (through a protective resistor of 1Ω/V).		

Product Availability Chart

Capacitance		Rated voltage (V.DC)					
		2.5	4.0	6.3	10	16	20
µF	Code						
0.10	104						P
0.15	154						P
0.22	224						P
0.33	334						P
0.47	474					P	P
0.68	684				P	P	P
1.0	105			P	P	P	
1.5	155		P	P	P		
2.2	225	P	P	P	P		
3.3	335	P	P	P	P		
4.7	475	P	P	P	P		
6.8	685	P	P	P			
10	106	P	P	P			

Standard Product Table

Rated Voltage V.DC	Capacitance		Case Code	DC Leakage Current mA*	Dissipation Factor (%)*	ESR (Ω)	Part Number**
	µF	Code					
2.5	2.2	225	P	0.5	6	35	TYTPP0E225(x)TRF
2.5	3.3	335	P	0.5	6	25	TYTPP0E335(x)TRF
2.5	4.7	475	P	0.5	6	20	TYTPP0E475(x)TRF
2.5	6.8	685	P	0.5	6	10	TYTPP0E685(x)TRF
2.5	10	106	P	0.5	6	6.5	TYTPP0E106(x)TRF
4.0	1.5	155	P	0.5	6	30	TYTPP0G155(x)TRF
4.0	2.2	225	P	0.5	6	25	TYTPP0G225(x)TRF
4.0	3.3	335	P	0.5	6	20	TYTPP0G335(x)TRF
4.0	4.7	475	P	0.5	6	10	TYTPP0G475(x)TRF
4.0	6.8	685	P	0.5	6	7.0	TYTPP0G685(x)TRF
4.0	10	106	P	0.5	6	15	TYTPP0G106(x)TRF
6.3	1.0	105	P	0.5	4	25	TYTPP0J105(x)TRF
6.3	1.5	155	P	0.5	6	25	TYTPP0J155(x)TRF
6.3	2.2	225	P	0.5	6	20	TYTPP0J225(x)TRF
6.3	3.3	335	P	0.5	6	12	TYTPP0J335(x)TRF
6.3	4.7	475	P	0.5	6	7.0	TYTPP0J475(x)TRF
6.3	6.8	685	P	0.5	6	15	TYTPP0J685(x)TRF
6.3	10	106	P	0.6	6	10	TYTPP0J106(x)TRF
10	0.68	684	P	0.5	4	30	TYTPP1A684(x)TRF
10	1.0	105	P	0.5	4	25	TYTPP1A105(x)TRF
10	1.5	155	P	0.5	6	25	TYTPP1A155(x)TRF
10	2.2	225	P	0.5	6	15	TYTPP1A225(x)TRF
10	3.3	335	P	0.5	6	10	TYTPP1A335(x)TRF
10	4.7	475	P	0.5	6	15	TYTPP1A475(x)TRF
16	0.47	474	P	0.5	4	25	TYTPP1C474(x)TRF
16	0.68	684	P	0.5	4	25	TYTPP1C684(x)TRF
16	1.0	105	P	0.5	4	20	TYTPP1C105(x)TRF
20	0.1	104	P	0.5	4	25	TYTPP1D104(x)TRF
20	0.15	154	P	0.5	4	25	TYTPP1D154(x)TRF
20	0.22	224	P	0.5	4	25	TYTPP1D224(x)TRF
20	0.33	334	P	0.5	4	25	TYTPP1D334(x)TRF
20	0.47	474	P	0.5	4	25	TYTPP1D474(x)TRF
20	0.68	684	P	0.5	4	25	TYTPP1D684(x)TRF

*DCL and DF measured at 20°C

** (x) = tolerance where K = 10%, M = 20%

Dimensions

Anode (+) End View

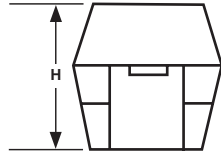

Side View

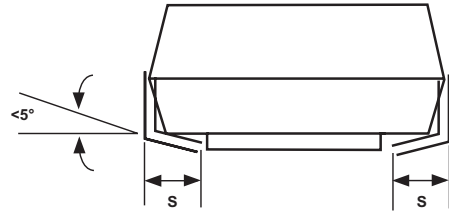

Cathode (-) End View

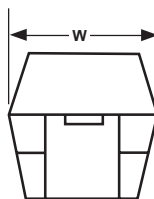

Bottom View

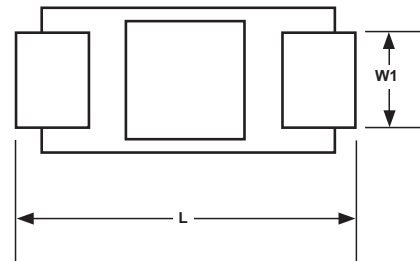

Case Code	Dimensions (mm)				
	L	W	H	S	W1
P	2.0±0.2	1.25±0.2	1.2±0.2	0.5±0.3	1.2±0.2

How to Order

TYTP	P	0E	105	K	TRF
Series	Case Code	Voltage Code	Capacitance	Tolerance	Packaging
TYTP	P	0E (2.5V) 0G (4.0V) 0J (6.3V) 1A (10V) 1C (16V) 1D (20V)	eg. 105	K (10%) M (20%)	TRF = 7" Reels (P Case 3000)

Type TYTR Series



The TYT series of moulded solid Tantalum chip capacitors is designed for high solder heat resistance and ease of automatic placement. The product is provided with both excellent frequency and impedance characteristics.

The four different product types cover the majority of requirements for this product series.

TYTS series is the standard type used in many industries and TYTM series extends this product range by applying advanced manufacturing technology, thereby allowing reduced sizes and extended value range.

TYTP series allows even further miniaturisation offering many values in an 0805 package size.

The series is completed with the TYTR series which offers a comprehensive range of low ESR products.

Key Features

- Suitable for High Frequency Applications
- Excellent Impedance Characteristics
- P, A, B, C, D & E Case Sizes
- 4V to 50V Ratings
- 10% or 20% Tolerance
- RoHS Compliant

Product Specifications

Product Specifications:		Test Conditions JIS C5101-3(1998)						
Operating Temp. Range:	-55°C ~ +125°C							
Rated Voltage:	DC4 ~ 50V	85°C						
Surge Voltage:	DC5 ~ 65V	85°C						
Derated Voltage:	DC2.5 ~ 33V	125°C						
Capacitance:	0.1 ~ 470µF							
Capacitance Tolerance:	±10% or 20%	Measuring Frequency:120Hz ±10%, Measurement Circuit: Equivalent Series Circuit: Measuring Voltage Max.: 0.5Vrms,+1.5Vdc.						
Leakage Current:	0.01 CV or less	Series Protective Resistor:1000Ω Measuring Voltage: Rated voltage Measuring Time: 5 minutes						
ESR (100kHz):	P Case 1000 ~ 6000mΩ ^{MAX} A Case 500 ~ 4000mΩ ^{MAX} B Case 500 ~ 2000mΩ ^{MAX} C Case 200 ~ 500mΩ ^{MAX} D Case 100 ~ 350mΩ ^{MAX} E Case 100 ~ 200mΩ ^{MAX}	Measuring Frequency: 100kHz						
Maximum Permitted Ripple Current (100kHz, 20°C):	P Case 120 ~ 300mA _{rms} ^{MAX} A Case 150 ~ 440mA _{rms} ^{MAX} B Case 220 ~ 400mA _{rms} ^{MAX} C Case 400 ~ 700mA _{rms} ^{MAX} D Case 500 ~ 1000mA _{rms} ^{MAX} E Case 770 ~ 1000mA _{rms} ^{MAX}	100kHz, 20°C						
Surge Withstanding Voltage:	C/C ±5% or less tanδ Specified initial value or less LC Specified initial value or less							
Temp. Characteristics:		Specified initial value	-55°C	+85°C	+125°C	Step	Temp.°C	Duration
	ΔC/C	—	-10~0%	0~+10%	0~+12%	1	+25±2	—
	tanδ Value shown table or less	0.06	<10V 12%	<10V 12%	<10V 15%	2	-55±2	30 min.
	LC	0.01CV	-	0.1CV	0.12CV	3	+25±2	30 min.
					4	+85±2	30 min.	
					5	+125±2	30 min.	
					6	+25±2	—	
Solder Heat Resistance:	ΔC/C ±10% or less tanδ Specified initial value or less LC Specified initial value or less	Conditioning of Solder Dip: Solder Temperature: 260 ±5°C Dip Duration: 5±0.5s Depth of Immersion: Under Surface 10mm						
Moisture Resistance:	ΔC/C ±10% or less tanδ Specified initial value or less LC Specified initial value or less	40°C 90 ~ 95% RH, 56 Days						
High-Temperature Load:	ΔC/C ±10% or less tanδ Specified initial value or less LC Specified initial value or less	85°C The rated voltage is applied for 2000 hours.						
Thermal Shock:	ΔC/C ±10% or less tanδ Specified initial value or less LC Specified initial value or less	Leave at -55°C, normal temperature, 125°C, and normal temperature for 30 min., 3 min., 30 min. and 3 min.. Repeat this operation 30 mins running						
Failure Rate:	1% / 2000h	85°C The rated voltage is applied (through a protective resistor of 1Ω/V).						

Product Availability Chart

Capacitance		Rated voltage (V.DC)							
		4.0	6.3	10	16	20	25	35	50
µF	Code								
0.1	104							A	A
0.15	154							A	A
0.22	224							A	B
0.33	334							A	B
0.47	474						A	A,B	B,C
0.68	684					A	A	A,B	B,C
1.0	105				A	A	A	A,B	C
1.5	155			A	A	A	A,B	B,C	C,D
2.2	225		A	A	A	A,B	B	B,C	C,D
3.3	335	A	A	A	A,B	A,B	B	B,C	D
4.7	475	A	A	P,A,B	A,B	A,B	B,C	C,D	D
6.8	685	A	P,A,B	A,B	A,B	B,C	C	C,D	E
10	106	P,A,B	P,A,B	A,B	A,B,C	B,C	C,D	C,D	E
15	156	A,B	A,B	A,B,C	B,C	C,D	C,D	D,E	
22	226	A,B	A,B,C	B,C	B,C,D	C,D	D	D,E	
33	336	B,C	B,C	B,C,D	C,D	D	D,E		
47	476	B,C	B,C,D	C,D	C,D	D	E		
68	686	B,C,D	C,D	C,D	D				
100	107	B,C,D	C,D	C,D	D,E				
150	157	C,D	C,D	D,E	E				
220	227	D	D	D					
330	337	D	D						
470	477	D							

Standard Product Table

Rated Voltage V.DC	Capacitance		Case Code	DC Leakage Current mA*	Dissipation Factor (%)*	ESR (Ω)*	Part Number**
	µF	Code					
4.0	3.3	335	A	0.5	6	4.0	TYTRA0G335(x)TRF
4.0	4.7	475	A	0.5	6	3.5	TYTRA0G475(x)TRF
4.0	6.8	685	A	0.5	6	3.0	TYTRA0G685(x)TRF
4.0	10	106	P	0.5	8	6.0	TYTRP0G106(x)TRF
4.0	10	106	A	0.5	6	2.0	TYTRA0G106(x)TRF
4.0	10	106	B	0.5	6	1.2	TYTRB0G106(x)TRF
4.0	15	156	A	0.6	6	1.5	TYTRA0G156(x)TRF
4.0	15	156	B	0.6	6	1.2	TYTRB0G156(x)TRF
4.0	22	226	A	0.9	6	1.5	TYTRA0G226(x)TRF
4.0	22	226	B	0.9	6	0.6	TYTRB0G226(x)TRF
4.0	33	336	B	1.3	6	0.5	TYTRB0G336(x)TRF
4.0	33	336	C	1.3	6	0.5	TYTRC0G336(x)TRF
4.0	47	476	B	1.9	6	0.5	TYTRB0G476(x)TRF
4.0	47	476	C	1.9	6	0.5	TYTRC0G476(x)TRF
4.0	68	686	B	2.7	6	2.0	TYTRB0G686(x)TRF
4.0	68	686	C	2.7	6	0.25	TYTRC0G686(x)TRF
4.0	68	686	D	2.7	6	0.2	TYTRD0G686(x)TRF
4.0	100	107	B	4.0	10	0.6	TYTRB0G107(x)TRF
4.0	100	107	C	4.0	8	0.2	TYTRC0G107(x)TRF
4.0	100	107	D	4.0	8	0.2	TYTRD0G107(x)TRF
4.0	150	157	C	6.0	8	0.3	TYTRC0G157(x)TRF
4.0	150	157	D	6.0	8	0.15	TYTRD0G157(x)TRF
4.0	220	227	D	8.8	8	0.15	TYTRD0G227(x)TRF
4.0	330	337	D	13.2	8	0.15	TYTRD0G337(x)TRF
4.0	470	477	D	18.8	8	0.15	TYTRD0G477(x)TRF

Standard Product Table (continued)

Rated Voltage V.DC	Capacitance		Case Code	DC Leakage Current mA*	Dissipation Factor (%)*	ESR (Ω)*	Part Number**
	μF	Code					
6.3	2.2	225	A	0.5	6	6.0	TYTRA0J225(x)TRF
6.3	3.3	335	A	0.5	6	6.0	TYTRA0J335(x)TRF
6.3	4.7	475	A	0.5	6	3.5	TYTRA0J475(x)TRF
6.3	6.8	685	P	0.5	6	8.0	TYTRP0J685(x)TRF
6.3	6.8	685	A	0.5	6	2.0	TYTRA0J685(x)TRF
6.3	6.8	685	B	0.5	6	1.2	TYTRB0J685(x)TRF
6.3	10	106	P	0.6	8	6.0	TYTRP0J106(x)TRF
6.3	10	106	A	0.6	6	2.0	TYTRA0J106(x)TRF
6.3	10	106	B	0.6	6	1.0	TYTRB0J106(x)TRF
6.3	15	156	A	0.9	6	2.0	TYTRA0J156(x)TRF
6.3	15	156	B	0.9	6	0.7	TYTRB0J156(x)TRF
6.3	22	226	A	1.4	6	3.0	TYTRA0J226(x)TRF
6.3	22	226	B	1.4	6	0.6	TYTRB0J226(x)TRF
6.3	22	226	C	1.4	6	0.5	TYTRC0J226(x)TRF
6.3	33	336	B	2.0	6	0.6	TYTRB0J336(x)TRF
6.3	33	336	C	2.0	6	0.3	TYTRC0J336(x)TRF
6.3	47	476	B	2.9	6	2.0	TYTRB0J476(x)TRF
6.3	47	476	C	2.9	6	0.25	TYTRC0J476(x)TRF
6.3	47	476	D	2.9	6	0.22	TYTRD0J476(x)TRF
6.3	68	686	C	4.1	6	0.2	TYTRC0J686(x)TRF
6.3	68	686	D	4.1	6	0.2	TYTRD0J686(x)TRF
6.3	100	107	C	6.0	8	0.3	TYTRC0J107(x)TRF
6.3	100	107	D	6.0	8	0.15	TYTRD0J107(x)TRF
6.3	150	157	C	9.0	8	0.3	TYTRC0J157(x)TRF
6.3	150	157	D	9.0	8	0.15	TYTRD0J157(x)TRF
6.3	220	227	D	13.2	8	0.15	TYTRD0J227(x)TRF
6.3	330	337	D	19.8	8	0.15	TYTRD0J337(x)TRF
10	1.5	155	A	0.5	6	6.0	TYTRA1A155(x)TRF
10	2.2	225	A	0.5	6	6.0	TYTRA1A225(x)TRF
10	3.3	335	A	0.5	6	4.0	TYTRA1A335(x)TRF
10	4.7	475	P	0.5	8	8.0	TYTRP1A475(x)TRF
10	4.7	475	A	0.5	6	3.0	TYTRA1A475(x)TRF
10	4.7	475	B	0.5	6	1.5	TYTRB1A475(x)TRF
10	6.8	685	A	0.7	6	3.0	TYTRA1A685(x)TRF
10	6.8	685	B	0.7	6	1.2	TYTRB1A685(x)TRF
10	10	106	A	1.0	6	2.0	TYTRA1A106(x)TRF
10	10	106	B	1.0	6	0.8	TYTRB1A106(x)TRF
10	15	156	A	1.5	8	4.0	TYTRA1A156(x)TRF
10	15	156	B	1.5	6	0.7	TYTRB1A156(x)TRF
10	15	156	C	1.5	6	0.5	TYTRC1A156(x)TRF
10	22	226	B	2.2	6	0.7	TYTRB1A226(x)TRF
10	22	226	C	2.2	6	0.4	TYTRC1A226(x)TRF
10	33	336	B	3.3	6	2.0	TYTRB1A336(x)TRF
10	33	336	C	3.3	6	0.3	TYTRC1A336(x)TRF
10	33	336	D	3.3	6	0.25	TYTRD1A336(x)TRF
10	47	476	C	4.7	6	0.3	TYTRC1A476(x)TRF
10	47	476	D	4.7	6	0.22	TYTRD1A476(x)TRF
10	68	686	C	6.8	6	0.3	TYTRC1A686(x)TRF
10	68	686	D	6.8	6	0.2	TYTRD1A686(x)TRF
10	100	107	C	10	8	0.3	TYTRC1A107(x)TRF
10	100	107	D	10	8	0.15	TYTRD1A107(x)TRF
10	150	157	D	15	8	0.15	TYTRD1A157(x)TRF
10	150	157	E	15	8	0.15	TYTRE1A157(x)TRF
10	220	227	D	22	8	0.15	TYTRD1A227(x)TRF

Standard Product Table (continued)

Rated Voltage V.DC	Capacitance		Case Code	DC Leakage Current mA*	Dissipation Factor (%)*	ESR (Ω)*	Part Number**
	μF	Code					
16	1.0	105	A	0.5	4	6.0	TYTRA1C105(x)TRF
16	1.5	155	A	0.5	6	6.0	TYTRA1C155(x)TRF
16	2.2	225	A	0.5	6	4.0	TYTRA1C225(x)TRF
16	3.3	335	A	0.5	6	4.0	TYTRA1C335(x)TRF
16	3.3	335	B	0.5	6	2.0	TYTRB1C335(x)TRF
16	4.7	475	A	0.8	6	3.0	TYTRA1C475(x)TRF
16	4.7	475	B	0.8	6	1.5	TYTRB1C475(x)TRF
16	6.8	685	A	1.1	6	3.0	TYTRA1C685(x)TRF
16	6.8	685	B	1.1	6	1.2	TYTRB1C685(x)TRF
16	10	106	A	1.6	8	3.0	TYTRA1C106(x)TRF
16	10	106	B	1.6	6	0.8	TYTRB1C106(x)TRF
16	10	106	C	1.6	6	0.6	TYTRC1C106(x)TRF
16	15	156	B	2.4	6	0.8	TYTRB1C156(x)TRF
16	15	156	C	2.4	6	0.4	TYTRC1C156(x)TRF
16	22	226	B	3.6	6	1.0	TYTRB1C226(x)TRF
16	22	226	C	3.6	6	0.35	TYTRC1C226(x)TRF
16	22	226	D	3.6	6	0.25	TYTRD1C226(x)TRF
16	33	336	C	5.3	6	0.3	TYTRC1C336(x)TRF
16	33	336	D	5.3	6	0.25	TYTRD1C336(x)TRF
16	47	476	C	7.5	6	0.55	TYTRC1C476(x)TRF
16	47	476	D	7.5	6	0.2	TYTRD1C476(x)TRF
16	68	686	D	10.9	6	0.15	TYTRD1C686(x)TRF
16	100	107	D	16	8	0.15	TYTRD1C107(x)TRF
16	100	107	E	16	8	0.15	TYTRE1C107(x)TRF
16	150	157	E	24	8	0.15	TYTRE1C157(x)TRF
20	0.68	684	A	0.5	4	8.0	TYTRA1D684(x)TRF
20	1.0	105	A	0.5	4	5.5	TYTRA1D105(x)TRF
20	1.5	155	A	0.5	6	4.5	TYTRA1D155(x)TRF
20	2.2	225	A	0.5	6	4.0	TYTRA1D225(x)TRF
20	2.2	225	B	0.5	6	1.5	TYTRB1D225(x)TRF
20	3.3	335	A	0.7	6	4.0	TYTRA1D335(x)TRF
20	3.3	335	B	0.7	6	1.3	TYTRB1D335(x)TRF
20	4.7	475	A	1.0	6	3.5	TYTRA1D475(x)TRF
20	4.7	475	B	1.0	6	1.0	TYTRB1D475(x)TRF
20	6.8	685	B	1.4	6	1.0	TYTRB1D685(x)TRF
20	6.8	685	C	1.4	6	0.6	TYTRC1D685(x)TRF
20	10	106	B	2.0	6	1.0	TYTRB1D106(x)TRF
20	10	106	C	2.0	6	0.5	TYTRC1D106(x)TRF
20	15	156	C	3.0	6	0.4	TYTRC1D156(x)TRF
20	15	156	D	3.0	6	0.35	TYTRD1D156(x)TRF
20	22	226	C	4.4	6	0.4	TYTRC1D226(x)TRF
20	22	226	D	4.4	6	0.3	TYTRD1D226(x)TRF
20	33	336	D	6.6	6	0.25	TYTRD1D336(x)TRF
20	47	476	D	9.4	6	0.2	TYTRD1D476(x)TRF
25	0.47	474	A	0.5	4	9.0	TYTRA1E474(x)TRF
25	0.68	684	A	0.5	4	6.0	TYTRA1E684(x)TRF
25	1.0	105	A	0.5	4	4.0	TYTRA1E105(x)TRF
25	1.5	155	A	0.5	6	5.0	TYTRA1E155(x)TRF
25	1.5	155	B	0.5	6	1.5	TYTRB1E155(x)TRF
25	2.2	225	B	0.6	6	2.2	TYTRB1E225(x)TRF
25	3.3	335	B	0.9	6	2.0	TYTRB1E335(x)TRF
25	4.7	475	B	1.2	6	1.0	TYTRB1E475(x)TRF
25	4.7	475	C	1.2	6	0.6	TYTRC1E475(x)TRF
25	6.8	685	C	1.7	6	0.6	TYTRC1E685(x)TRF
25	10	106	C	2.5	6	0.6	TYTRC1E106(x)TRF

Standard Product Table (continued)

Rated Voltage V.DC	Capacitance		Case Code	DC Leakage Current mA*	Dissipation Factor (%)*	ESR (Ω)*	Part Number**
	μF	Code					
25	10	106	D	2.5	6	0.4	TYTRD1E106(x)TRF
25	15	156	C	3.8	6	0.9	TYTRC1E156(x)TRF
25	15	156	D	3.8	6	0.4	TYTRD1E156(x)TRF
25	22	226	D	5.5	6	0.4	TYTRD1E226(x)TRF
25	33	336	D	8.3	6	0.4	TYTRD1E336(x)TRF
25	33	336	E	8.3	6	0.3	TYTRE1E336(x)TRF
25	47	476	E	11.8	6	0.3	TYTRE1E476(x)TRF
35	0.1	104	A	0.5	4	10	TYTRA1V104(x)TRF
35	0.15	154	A	0.5	4	6.0	TYTRA1V154(x)TRF
35	0.22	224	A	0.5	4	6.0	TYTRA1V224(x)TRF
35	0.33	334	A	0.5	4	6.0	TYTRA1V334(x)TRF
35	0.47	474	A	0.5	4	4.0	TYTRA1V474(x)TRF
35	0.47	474	B	0.5	4	2.5	TYTRB1V474(x)TRF
35	0.68	684	A	0.5	4	6.0	TYTRA1V684(x)TRF
35	0.68	684	B	0.5	4	2.5	TYTRB1V684(x)TRF
35	1.0	105	A	0.5	4	6.0	TYTRA1V105(x)TRF
35	1.0	105	B	0.5	4	2.0	TYTRB1V105(x)TRF
35	1.5	155	B	0.5	6	3.0	TYTRB1V155(x)TRF
35	1.5	155	C	0.5	6	2.5	TYTRC1V155(x)TRF
35	2.2	225	B	0.8	6	2.5	TYTRB1V225(x)TRF
35	2.2	225	C	0.8	6	1.5	TYTRC1V225(x)TRF
35	3.3	335	B	1.2	6	2.0	TYTRB1V335(x)TRF
35	3.3	335	C	1.2	6	0.8	TYTRC1V335(x)TRF
35	4.7	475	C	1.7	6	0.7	TYTRC1V475(x)TRF
35	4.7	475	D	1.7	6	0.7	TYTRD1V475(x)TRF
35	6.8	685	C	2.4	6	0.9	TYTRC1V685(x)TRF
35	6.8	685	D	2.4	6	0.5	TYTRD1V685(x)TRF
35	10	106	C	3.5	6	1.2	TYTRC1V106(x)TRF
35	10	106	D	3.5	6	0.4	TYTRD1V106(x)TRF
35	15	156	D	5.3	6	0.35	TYTRD1V156(x)TRF
35	15	156	E	5.3	6	0.3	TYTRE1V156(x)TRF
35	22	226	D	7.7	6	0.4	TYTRD1V226(x)TRF
35	22	226	E	7.7	6	0.3	TYTRE1V226(x)TRF
50	0.1	104	A	0.5	4	10	TYTRA1H104(x)TRF
50	0.15	154	A	0.5	4	10	TYTRA1H154(x)TRF
50	0.15	154	B	0.5	4	10	TYTRB1H154(x)TRF
50	0.22	224	B	0.5	4	10	TYTRB1H224(x)TRF
50	0.33	334	B	0.5	4	2.5	TYTRB1H334(x)TRF
50	0.47	474	B	0.5	4	2.0	TYTRB1H474(x)TRF
50	0.47	474	C	0.5	4	1.8	TYTRC1H474(x)TRF
50	0.68	684	B	0.5	4	3.0	TYTRB1H684(x)TRF
50	0.68	684	C	0.5	4	1.6	TYTRC1H684(x)TRF
50	1.0	105	C	0.5	4	1.6	TYTRC1H105(x)TRF
50	1.5	155	C	0.8	6	1.5	TYTRC1H155(x)TRF
50	1.5	155	D	0.8	6	1.0	TYTRD1H155(x)TRF
50	2.2	225	C	1.1	6	1.5	TYTRC1H225(x)TRF
50	2.2	225	D	1.1	6	0.8	TYTRD1H225(x)TRF
50	3.3	335	D	1.7	6	0.8	TYTRD1H335(x)TRF
50	4.7	475	D	2.4	6	0.6	TYTRD1H475(x)TRF
50	6.8	685	E	3.5	6	0.5	TYTRE1H685(x)TRF
50	10	106	E	5.0	6	0.5	TYTRE1H106(x)TRF

*DCL measured at 25°C

*DF measured at 25°C, 125Hz max

*ESR measured at 25°C, 120kHz max

** (x) = tolerance where K = 10%, M = 20%

Dimensions

Anode (+) End View

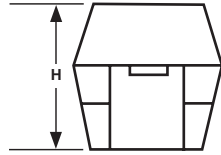

Side View

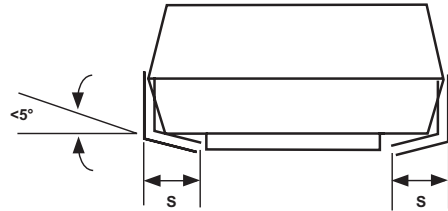

Cathode (-) End View

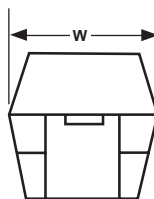

Bottom View

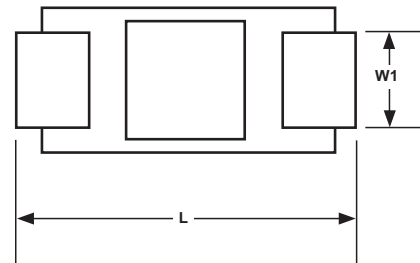

Case Code	Dimensions (mm)				
	L	W	H	S	W1
P	2.0±0.2	1.3±0.2	1.2±0.2	0.5±0.3	1.2±0.1
A	3.2±0.2	1.6±0.2	1.6±0.2	0.8±0.3	1.2±0.1
B	3.5±0.2	2.8±0.2	1.9±0.2	0.8±0.3	2.2±0.1
C	6.0±0.3	3.2±0.3	2.5±0.3	1.3±0.3	2.2±0.1
D	7.3±0.3	4.3±0.3	2.8±0.3	1.3±0.3	2.4±0.1
E	7.3±0.3	4.3±0.3	4.0±0.3	1.3±0.3	2.4±0.1

How to Order

TYTR	A	0G	106	K	TRF
Series	Case Code	Voltage Code	Capacitance	Tolerance	Packaging
TYTR	P, A, B, C, D or E	0G (4.0V) 0J (6.3V) 1A (10V) 1C (16V) 1D (20V) 1E (25V) 1V (35V) 1H (50V)	eg. 106	K (10%) M (20%)	TRF = 7" Reels (P Case 3000) (A, B Case 2000) (C, D, E Case 500)



SMD MLCC Capacitors - Product Overview

The TYC Range Multilayer Ceramic (MLCC) capacitors are available in NPO(COG), X7R, X5R or Y5V(Z5U) dielectrics. Available in a wide range of case sizes from 0402 to 1812 as standard. Standard operating voltages range from 6.3 to 50V, plus 100 to 3000V in selected ranges.

- Surface mount case sizes down to 0402 size
- Tape and reel packaging
- Wide tolerance range
- RoHS compliant

Dielectric	Case Size	Capacitance Range	Standard Tolerance	Voltage Range	Series	Page
NPO(COG)	0402 to 1812	0.5pF to 0.1µF	±5%	10 to 3000V	TYC-A	27
X7R	0402 to 1812	100pF to 10µF	±10%	10 to 3000V	TYC-B	29
X5R	0402 to 1812	68nF to 100µF	+80%/-20%	6.3 to 16V	TYC-C	29
Y5V(Z5U)	0402 to 1812	1000pF to 47µF	+80%/-20%	6.3 to 250V	TYC-D	31

Type TYC Series



Multilayer ceramic capacitors (MLCC) are manufactured by suspending ceramic powders in liquid and casting into a thin green sheet from 20mm in thickness to 5mm or thinner.

Metal electrodes are sieved printed onto green sheets, which are later stacked to form a laminated structure. The metal electrodes are arranged so that the termination alternates from one edge to another of the capacitor.

Upon sintering at high temperature the part becomes a monolithic block, which can provide an extremely high capacitance in small mechanical volumes.

Finally, the termination electrodes are formed by composite of outer metal-glass electrode and followed by a barrier layer and pure-tin plating to permit MLCC to be soldered directly onto printed circuit board.

Key Features

- Choice of Dielectrics (NP0, X7R, X5R, Y5V)
- 0402 to 1812 sizes as standard
- Other sizes available. 0201 available soon
- 6.3V to 50V in standard range
- Voltage ratings to 3kV on selected products
- Range of tolerances available
- RoHS Compliant
- Excellent thermal stability
- Low dissipation factor

Structure

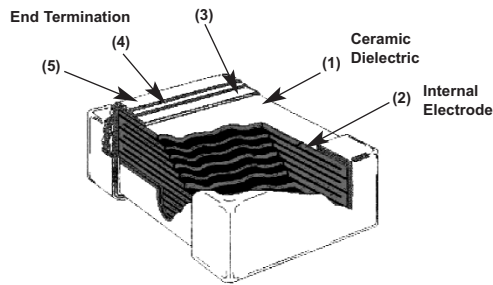

Class 1

No	Specifications	Material	
1	Ceramic dielectric	Barium titanate base	
2	Internal Electrode	Pb, PdAg	
3	Inner Layer	Ag	
4	End Terminal	Middle Layer	Ni
5	Outer Layer	Sn	

Class 2

No	Specifications	Material	
1	Ceramic dielectric	Barium titanate base	
2	Internal Electrode	Pb, PbAg Ni	
3	Inner Layer	Ag Cu	
4	End Terminal	Middle Layer	Ni
5	Outer Layer	Sn	

Dimensions

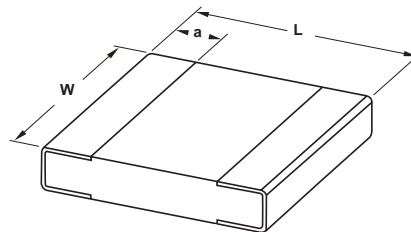

Size Code	L	W	A
0402	1.00±0.05	0.50±0.05	0.25±0.05/-0.10
0603	1.60±0.10	0.80±0.07	0.40±0.15
0805	2.00±0.15	1.25±0.10	0.50±0.20
1206	3.20±0.15	1.60±0.15	0.60±0.20
1210	3.20±0.30	2.50±0.20	0.75±0.25
1808	4.50±0.40	2.03±0.25	0.75±0.25
1812	4.50±0.40	3.20±0.30	0.75±0.25

Capacitance & Voltage (NPO)

EIA Code	Size	0402				0603				0805				1206				1210				1812							
	VDCW	10V	16V	25V	50V	10V	16V	25V	50V	10V	16V	25V	50V	10V	16V	25V	50V	10V	16V	25V	50V	10V	16V	25V	50V	10V	16V	25V	50V
0R5	0.5pF	N	N	N	N	S	S	S	S	A	A	A	A																
1R0	1	N	N	N	N	S	S	S	S	A	A	A	A																
1R2	1.2	N	N	N	N	S	S	S	S	A	A	A	A																
1R5	1.5	N	N	N	N	S	S	S	S	A	A	A	A	B	B	B	B												
1R8	1.8	N	N	N	N	S	S	S	S	A	A	A	A	B	B	B	B												
2R2	2.2	N	N	N	N	S	S	S	S	A	A	A	A	B	B	B	B												
2R7	2.7	N	N	N	N	S	S	S	S	A	A	A	A	B	B	B	B												
3R3	3.3	N	N	N	N	S	S	S	S	A	A	A	A	B	B	B	B												
3R9	3.9	N	N	N	N	S	S	S	S	A	A	A	A	B	B	B	B												
4R7	4.7	N	N	N	N	S	S	S	S	A	A	A	A	B	B	B	B												
5R6	5.6	N	N	N	N	S	S	S	S	A	A	A	A	B	B	B	B												
6R8	6.8	N	N	N	N	S	S	S	S	A	A	A	A	B	B	B	B												
8R2	8.2	N	N	N	N	S	S	S	S	A	A	A	A	B	B	B	B												
100	10pF	N	N	N	N	S	S	S	S	A	A	A	A	B	B	B	B												
120	12	N	N	N	N	S	S	S	S	A	A	A	A	B	B	B	B												
150	15	N	N	N	N	S	S	S	S	A	A	A	A	B	B	B	B												
180	18	N	N	N	N	S	S	S	S	A	A	A	A	B	B	B	B												
220	22	N	N	N	N	S	S	S	S	A	A	A	A	B	B	B	B	C	C	C	C								
270	27	N	N	N	N	S	S	S	S	A	A	A	A	B	B	B	B	C	C	C	C								
330	33	N	N	N	N	S	S	S	S	A	A	A	A	B	B	B	B	C	C	C	C								
390	39	N	N	N	N	S	S	S	S	A	A	A	A	B	B	B	B	C	C	C	C								
470	47	N	N	N	N	S	S	S	S	A	A	A	A	B	B	B	B	C	C	C	C								
560	56	N	N	N	N	S	S	S	S	A	A	A	A	B	B	B	B	C	C	C	C								
680	68	N	N	N	N	S	S	S	S	A	A	A	A	B	B	B	B	C	C	C	C								
820	82	N	N	N	N	S	S	S	S	A	A	A	A	B	B	B	B	C	C	C	C								
101	100pF	F	N	N	N	S	S	S	S	A	A	A	A	B	B	B	B	C	C	C	C								
121	120	N	N	N	N	S	S	S	S	A	A	A	A	B	B	B	B	C	C	C	C								
151	150	N	N	N	N	S	S	S	S	A	A	A	A	B	B	B	B	C	C	C	C								
181	180	N	N	N	N	S	S	S	S	A	A	A	A	B	B	B	B	C	C	C	C								
221	220	N	N	N	N	S	S	S	S	A	A	A	A	B	B	B	B	C	C	C	C								
271	270	N	N	N	N	S	S	S	S	A	A	A	A	B	B	B	B	C	C	C	C								
331	330	N	N	N	N	S	S	S	S	A	A	A	A	B	B	B	B	C	C	C	C								
391	390	N	N			S	S	S	S	B	B	B	B	B	B	B	B	C	C	C	C								
471	470	N	N			S	S	S	S	B	B	B	B	B	B	B	B	C	C	C	C								
561	560					S	S	S	S	B	B	B	B	B	B	B	B	C	C	C	C								
681	680					S	S	S	S	B	B	B	B	B	B	B	B	C	C	C	C								
821	820					S	S	S	S	B	B	B	B	B	B	B	B	C	C	C	C								
102	1000pF					S	S	S	S	B	B	B	B	B	B	B	B	C	C	C	C	D	D	D	D				
122	1200					S	S	S	S	B	B	B	B	B	B	B	B	C	C	C	C	D	D	D	D				
152	1500					S	S	S	S	B	B	B	B	B	B	B	B	C	C	C	C	D	D	D	D				
182	1800					S	S	S	S	B	B	B	B	B	B	B	B	C	C	C	C	D	D	D	D				
222	2200					S	S	S	S	B	B	B	B	B	B	B	B	C	C	C	C	D	D	D	D				
272	2700					S	S	D	D	D	D			B	B	B	B	C	C	C	C	D	D	D	D				
332	3300					S	S	D	D	D	D			B	B	B	B	C	C	C	C	D	D	D	D				
392	3900									D	D	D	D	B	B	B	B	C	C	C	C	D	D	D	D				
472	4700									D	D	D	D'	B	B	B	B	C	C	C	C	D	D	D	D				
562	5600									D	D			B	B	B	B	C	C	C	C	D	D	D	D				
682	6800									D	D			C	C	C	C					D	D	D	D				
822	8200									D	D			C	C	C	C					D	D	D	D				
103	0.01µF									D	D		D'									D	D	D	D				
123	0.012																					D	D	D	D				
153	0.015																					D	D	D	D				
183	0.018																					D	D	D	D				
223	0.022																					D	D	D	D				
273	0.027																					D	D	D	D				
333	0.033																					D	D	D	D				
393	0.039																					D	D	D	D				
473	0.047																					D	D	D	D				
563	0.056																					D	D	D	D				
683	0.068																					D	D	D	D				
823	0.082																					D	D	D	D				
104	0.1µF									D	D											D	D	D	D				

(1) [D']: The thickness spec. of said items is special defined on 1.25±0.2mm for 0805 and 1.15±0.15mm for 1206.

Size Unit: Inch (mm)	0402 (1005)	0603 (1608)	0805 (2012)	1206 (3216)	1210 (3225)	1808 (4520)	1812 (4532)
A= 0.60±0.10 mm	-	-	Paper 4Kp/reel	-	-	-	-
B= 0.80±0.10 mm	-	-	Paper 4Kp/reel	Paper 4Kp/reel	-	-	-
C= 0.95±0.10 mm	-	-	-	Plastic 3Kp/reel	Plastic 3Kp/reel	-	-
D= 1.25±0.10 mm	-	-	Plastic 3Kp/reel	Plastic 3Kp/reel	Plastic 3Kp/reel	Plastic 2Kp/reel	Plastic 1Kp/reel

Capacitance & Voltage (Hi-Voltage NPO)

EIA Code	Size	0603	0805				1206				1210				1808			1812								
	VDCW	100	100	200	250	500	100	200	250	500	1000	2000	100	200	250	500	1000	2000	3000	100	200	250	500	1000	2000	3000
0R5	0.5pF	S	A	A	A	A																				
1R0	1	S	A	A	A	A																				
1R2	1.2	S	A	A	A	A																				
1R5	1.5	S	A	A	A	A	B	B	B	B	B	B														
1R8	1.8	S	A	A	A	A	B	B	B	B	B	B														
2R2	2.2	S	A	A	A	A	B	B	B	B	B	B														
2R7	2.7	S	A	A	A	A	B	B	B	B	B	B														
3R3	3.3	S	A	A	A	A	B	B	B	B	B	B														
3R9	3.9	S	A	A	A	A	B	B	B	B	B	B														
4R7	4.7	S	A	A	A	A	B	B	B	B	B	B														
5R6	5.6	S	A	A	A	A	B	B	B	B	B	B														
6R8	6.8	S	A	A	A	A	B	B	B	B	B	B														
8R2	8.2	S	A	A	A	A	B	B	B	B	B	B														
100	10pF	S	A	A	A	A	B	B	B	B	B	B	C	C	C	C	C	C	C	D	D	D	D	D	D	D
120	12	S	A	A	A	A	B	B	B	B	B	B	C	C	C	C	C	C	C	D	D	D	D	D	D	D
150	15	S	A	A	A	A	B	B	B	B	B	B	C	C	C	C	C	C	D	D	D	D	D	D	D	D
180	18	S	A	A	A	A	B	B	B	B	B	B	C	C	C	C	C	C	D	D	D	D	D	D	D	D
220	22	S	A	A	A	A	B	B	B	B	B	B	C	C	C	C	C	C	D	D	D	D	D	D	D	D
270	27	S	A	A	A	A	B	B	B	B	B	B	C	C	C	C	C	C	D	D	D	D	D	D	D	D
330	33	S	A	A	A	A	B	B	B	B	B	B	C	C	C	C	C	C	D	D	D	D	D	D	D	D
390	39	S	A	A	A	A	B	B	B	B	B	B	C	C	C	C	C	C	D	D	D	D	D	D	D	D
470	47	S	A	A	A	A	B	B	B	B	B	B	C	C	C	C	C	C	D	D	D	D	D	D	D	D
560	56	S	A	A	A	A	B	B	B	B	B	B	C	C	C	C	C	D	D	D	D	D	D	D	D	D
680	68	S	A	A	A	A	B	B	B	B	B	B	C	C	C	C	C	D	D	D	D	D	D	D	D	D
820	82	S	A	A	A	A	B	B	B	B	B	B	C	C	C	C	C	D	D	D	D	D	D	D	D	D
101	100pF	S	A	A	A	A	B	B	B	B	B	B	C	C	C	C	C	D	D	D	D	D	D	D	D	D
121	120	S	A	A	A	A	D	B	B	B	B	B	D	C	C	C	C	C	D	D	D	D	D	D	D	D
151	150	S	A	B	B	D	B	B	B	B	C	D	C	C	C	C	C	D	D	D	D	D	D	D	D	D
181	180	S	A	B	B	D	B	B	B	B	C	G	C	C	C	C	C	D	D	D	K	D	D	D	D	D
221	220	S	A	D	D	D	B	B	B	B	D	G	C	C	C	C	C	D	D	D	K	D	D	D	D	D
271	270	S	A	D	D	D	B	B	B	B	C	D	C	C	C	C	C	D	D	D	K	D	D	D	D	K
331	330	S	A	D	D	D	B	B	B	C			C	C	C	C	D		D	D		D	D	D	D	K
391	390	S	B	D	D	D	B	B	B	C			C	C	C	C	D		D	K		D	D	D	D	K
471	470	S	B	D	B	C	C	C	C				C	C	C	C	D		D	K		D	D	D	D	K
561	560	S	B	D	B	C	C	C	C				C	C	C	C			K	K		D	D	D	D	D
681	680	B	D	B	C	C	C						C	C	C	C			K	K		D	D	D	D	K
821	820	B	D	B	C	D	D						C	C	C	C			K	K		D	D	D	D	K
102	1000pF	B	B		C								C	C	C	C			K			D	D	D	D	K
122	1200	B	B	C									C	D	D	D						D	D	D	D	K
152	1500	B	B	C									C	D	D	D						D	D	D	D	K
182	1800	B	B	C									C	D	D	D						D	D	D	D	
222	2200	B	B	D									C	D	D	D						D	D	D	D	
272	2700	D	B										C	D	D	D						D	D	D	D	
332	3300	D	B										C	D								D	D	D	D	
392	3900	D	B										C	D								D	D			
472	4700	B											C									D	D			
562	5600	B											C									D	D			
682	6800	C											C									D	D			
822	8200	C											C									D				
103	0.01μF												C									D				
123	0.012												D									D				
153	0.015												D									D				
183	0.018																					D				
223	0.022																					D				
273	0.027																					D				
333	0.033μF																					D				

Size Unit:	Inch (mm)	0402 (1005)	0603 (1608)	0805 (2012)	1206 (3216)	1210 (3225)	1808 (4520)	1812 (4532)
A =	0.60±0.10 mm	-	-	Paper 4Kp/reel	-	-	-	-
B =	0.80±0.10 mm	-	-	Paper 4Kp/reel	Paper 4Kp/reel	-	-	-
C =	0.95±0.10 mm	-	-	-	Plastic 3Kp/reel	Plastic 3Kp/reel	-	-
D =	1.25±0.10 mm	-	-	Plastic 3Kp/reel	Plastic 3Kp/reel	Plastic 3Kp/reel	Plastic 2Kp/reel	Plastic 1Kp/reel
G =	1.60±0.20 mm	-	-	-	Plastic 2Kp/reel	Plastic 2Kp/reel	-	-
S =	0.80±0.07 mm	-	Paper 4Kp/reel	-	-	-	-	-
N =	0.50±0.05 mm	Paper 10Kp/reel	-	-	-	-	-	-
K =	2.00±0.20 mm	-	-	-	-	Plastic 2Kp/reel	Plastic 1Kp/reel	Plastic 1Kp/reel
M =	2.50±0.30 mm	-	-	-	-	Plastic 1Kp/reel	-	Plastic 1Kp/reel

Capacitance & Voltage (X7R/X5R)

EIA Code	Size VDCW	0402				0603				0805				1206				1210				1812									
		10V	16V	25V	50V	6.3V	10V	16V	25V	50V	6.3V	10V	16V	25V	50V	6.3V	10V	16V	25V	50V	6.3V	10V	16V	25V	50V						
101	100pF	N	N	N	N		S	S	S	S		B	B	B	B																
121	120	N	N	N	N		S	S	S	S		B	B	B	B																
151	150	N	N	N	N		S	S	S	S		B	B	B	B																
181	180	N	N	N	N		S	S	S	S		B	B	B	B		B ¹	B ¹	B ¹	B ¹											
221	220	N	N	N	N		S	S	S	S		B	B	B	B		B ¹	B ¹	B ¹	B ¹											
271	270	N	N	N	N		S	S	S	S		B	B	B	B		B ¹	B ¹	B ¹	B ¹											
331	330	N	N	N	N		S	S	S	S		B	B	B	B		B ¹	B ¹	B ¹	B ¹											
391	390	N	N	N	N		S	S	S	S		B	B	B	B		B ¹	B ¹	B ¹	B ¹											
471	470	N	N	N	N		S	S	S	S		B	B	B	B		B ¹	B ¹	B ¹	B ¹											
561	560	N	N	N	N		S	S	S	S		B	B	B	B		B ¹	B ¹	B ¹	B ¹											
681	680	N	N	N	N		S	S	S	S		B	B	B	B		B ¹	B ¹	B ¹	B ¹											
821	820	N	N	N	N		S	S	S	S		B	B	B	B		B	B	B	B											
102	1000pF	N	N	N	N		S	S	S	S		B	B	B	B		B	B	B	B		C ²	C ²	C ²	C ²	D ³	D ³	D ³	D ³		
122	1200	N	N	N	N		S	S	S	S		B	B	B	B		B	B	B	B		C ²	C ²	C ²	C ²	D ³	D ³	D ³	D ³		
152	1500	N	N	N	N		S	S	S	S		B	B	B	B		B	B	B	B		C ²	C ²	C ²	C ²	D ³	D ³	D ³	D ³		
182	1800	N	N	N	N		S	S	S	S		B	B	B	B		B	B	B	B		C ²	C ²	C ²	C ²	D ³	D ³	D ³	D ³		
222	2200	N	N	N	N		S	S	S	S		B	B	B	B		B	B	B	B		C ²	C ²	C ²	C ²	D ³	D ³	D ³	D ³		
272	2700	N	N	N	N		S	S	S	S		B	B	B	B		B	B	B	B		C ²	C ²	C ²	C ²	D ³	D ³	D ³	D ³		
332	3300	N	N	N	N		S	S	S	S		B	B	B	B		B	B	B	B		C ²	C ²	C ²	C ²	D ³	D ³	D ³	D ³		
392	3900	N	N	N	N		S	S	S	S		B	B	B	B		B	B	B	B		C ²	C ²	C ²	C ²	D ³	D ³	D ³	D ³		
472	4700	N	N	N	N		S	S	S	S		B	B	B	B		B	B	B	B		C ²	C ²	C ²	C ²	D ³	D ³	D ³	D ³		
562	5600	N	N	N	N		S	S	S	S		B	B	B	B		B	B	B	B		C ²	C ²	C ²	C ²	D ³	D ³	D ³	D ³		
682	6800	N	N	N	N		S	S	S	S		B	B	B	B		B	B	B	B		C ²	C ²	C ²	C ²	D ³	D ³	D ³	D ³		
822	8200	N	N	N	N		S	S	S	S		B	B	B	B		B	B	B	B		C	C	C	C	D ³	D ³	D ³	D ³		
103	0.01µF	N	N	N	N		S	S	S	S		B	B	B	B		B	B	B	B		C	C	C	C	D ³	D ³	D ³	D ³		
123	0.012	N	N	N	N		S	S	S	S		B	B	B	B		B	B	B	B		C	C	C	C	D ³	D ³	D ³	D ³		
153	0.015	N	N	N	N		S	S	S	S		B	B	B	B		B	B	B	B		C	C	C	C	D ³	D ³	D ³	D ³		
183	0.018	N	N	N	N		S	S	S	S		B	B	B	B		B	B	B	B		C	C	C	C	D ³	D ³	D ³	D ³		
223	0.022	N	N	N	N		S	S	S	S		B	B	B	B		B	B	B	B		C	C	C	C	D ³	D ³	D ³	D ³		
273	0.027	N	N	N	N		S	S	S	S		B	B	B	B		B	B	B	B		C	C	C	C	D ³	D ³	D ³	D ³		
333	0.033	N	N	N	N		S	S	S	S		B	B	B	B		B	B	B	B		C	C	C	C	D ³	D ³	D ³	D ³		
393	0.039	N	N	N	N		S	S	S	S		B	B	B	B		B	B	B	B		C	C	C	C	D ³	D ³	D ³	D ³		
473	0.047	N	N	N	N		S	S	S	S		B	B	B	B		B	B	B	B		C	C	C	C	D ³	D ³	D ³	D ³		
563	0.056	N	N	N	N		S	S	S	S		B	B	B	B		B	B	B	B		C	C	C	C	D ³	D ³	D ³	D ³		
683	0.068	*N	N	N	N		S	S	S	S		B	B	B	B		B	B	B	B		C	C	C	C	D ³	D ³	D ³	D ³		
823	0.082	*N	N	N	N		S	S	S	S		B	B	B	D		B	B	B	B		C	C	C	C	D	D	D	D		
104	0.1µF	*N	N	N	N		S	S	S	S		B	B	B	D		B	B	B	B		C	C	C	C	D	D	D	D		
124	0.12	N	N	N	N		S	S	S	S		B	B	B	D		B	B	B	B		C	C	C	C	D	D	D	D		
154	0.15	N	N	N	N		S	S	S	S		D	D	D	D		C	C	C	C		C	C	C	C	D	D	D	D		
184	0.18	N	N	N	N		S	S	S	S		D	D	D	D		C	C	C	C		C	C	C	C	D	D	D	D		
224	0.22	N	N	N	N		S	S	S	S		D	D	D	D		C	C	C	C		C	C	C	C	D	D	D	D		
274	0.27	N	N	N	N		S	S	S	S		D	D	D	D		C	C	C	C		C	C	C	C	D	D	D	D		
334	0.33	N	N	N	N		*S	S	S	S		D	D	D	D		C	C	C	C		C	C	C	C	D	D	D	D		
394	0.39	N	N	N	N		S	S	S	S		D	D	D	D		C	C	C	C		C	C	C	C	D	D	D	D		
474	0.47	N	N	N	N		*S	S	S	S		D	D	D	D		D	D	D	G		C	C	C	C	D	D	D	D		
564	0.56	N	N	N	N		S	S	S	S		D	D	D	D		D	D	D	D					D	D	D	D	D		
684	0.68	N	N	N	N		S	S	S	S		D	D	D	D		D	D	D	D					D	D	D	D	K		
824	0.82	N	N	N	N		S	S	S	S		D	D	D	D		D	D	D	D					D	D	D	D	K		
105	1µF	N	N	N	N		*S	*S	S	S		D	D	D	D		D	D	D	G		G	G	G	D	D	D	D	K		
225	2.2	N	N	N	N		*S	S	S	S		*D	*D	S	S		*D	*D	G	G		K	K	K	K						
335	3.3	N	N	N	N		S	S	S	S		*D	*D	S	S		*G	*G	*G	*G		K	K	K	K						
475	4.7	N	N	N	N		S	S	S	S		*D	*D	S	S		*G	*G	*G	*G		K	K	K	K						
685	6.8	N	N	N	N		S	S	S	S		S	S	S	S		S	S	S	S											
106	10µF	N	N	N	N		S	S	S	S		*D	S	S	S		*G	*G	S	S		*K	*K	*K						M	
226	22µF	N	N	N	N		S	S	S	S		S	S	S	S		*G	*G	S	S		*M	*M							M	
107	100µF	N	N	N	N		S	S	S	S		S	S	S	S		S	S	S	S						*U					

(1) [*]: The said items are made by NME (Noble Metal Electrode).
 (2) [*]: The said items are available in X5R.
 (3) [S]: The thickness spec. of said items is special defined on 0.80±0.15/0.1mm.
 (4) [D]: The thickness spec. of said items is special defined on 1.25±0.2mm for 0805 and 1.15±0.15mm for 1206.
 (5) [G]: The thickness spec. of said items is special defined on 1.60±0.3/0.1mm.

Size Unit: Inch (mm)	0402 (1005)	0603 (1608)	0805 (2012)	1206 (3216)	1210 (3225)	1808 (4520)	1812 (4532)
A= 0.60±0.10 mm	-	-	Paper 4Kp/reel	-	-	-	-
B= 0.80±0.10 mm	-	-	Paper 4Kp/reel	Paper 4Kp/reel	-	-	-
C= 0.95±0.10 mm	-	-	-	Plastic 3Kp/reel	Plastic 3Kp/reel	-	-
D= 1.25±0.10 mm	-	-	Plastic 3Kp/reel	Plastic 3Kp/reel	Plastic 3Kp/reel	Plastic 2Kp/reel	Plastic 1Kp/reel
G= 1.60±0.20 mm	-	-	-	Plastic 2Kp/reel	Plastic 2Kp/reel	-	-
S= 0.80±0.07 mm	-	Paper 4Kp/reel	-	-	-	-	-
N= 0.50±0.05 mm	Paper 10Kp/reel	-	-	-	-	-	-
K= 2.00±0.20 mm	-	-	-	-	Plastic 2Kp/reel	Plastic 1Kp/reel	Plastic 1Kp/reel
M= 2.50±0.30 mm	-	-	-	-	Plastic 1Kp/reel	-	Plastic 1Kp/reel
U= 2.80±0.30 mm	-	-	-	-	-	-	Plastic 0.5Kp/reel

Capacitance & Voltage (Hi-Voltage X7R)

EIA Code	Size VDCW	0603	0805					1206						1210					1808			1812						
Code	VDCW	100	100	200	250	500	100	200	250	500	1000	1500	2000	100	200	250	500	1000	1000	1500	2000	100	200	250	500	1000	2000	3000
101	100pF	S	B	B^	B^	B^																						
121	120	S	B	B^	B^	B^																						
151	150	S	B	B^	B^	B^	B^	B^	B^	B^	B^	B^	B^						D^	D^	D^							
181	180	S	B	B^	B^	B^	B^	B^	B^	B^	B^	B^	B^						D^	D^	D^							
221	220	S	B	B^	B^	B^	B^	B^	B^	B^	B^	B^	B^						D^	D^	D^							
271	270	S	B	B^	B^	B^	B^	B^	B^	B^	B^	B^	B^						D^	D^	D^					D^	D^	
331	330	S	B	B^	B^	B^	B^	B^	B^	B^	B^	B^	B^						D^	D^	D^					D^	D^	
391	390	S	B	B^	B^	B^	B^	B^	B^	B^	B^	B^	C^						D^	D^	D^					D^	D^	
471	470	S	B	B^	B^	B^	B^	B^	B^	B^	B^	B^	C^						D^	D^	D^					D^	D^	
561	560	S	B	B^	B^	B^	B^	B^	B^	B^	B^	B^	C^	C^					D^	D^	D^					D^	D^	
681	680	S	B	B^	B^	B^	B^	B^	B^	B^	B^	B^	C^	C^					D^	D^	D^					D^	D^	K^
821	820	S	B	B^	B^	B^	B	B^	B^	B^	B^	G^	G^						D^	D^	D^					D^	D^	K^
102	1000pF	S	B	B^	B^	B^	B	B^	B^	B^	B^	G^	G^	C^	C^	C^	C^	C^	D^	D^	K^	D^	D^	D^	D^	D^	D^	K^
122	1200	S	B	B^	B^	B^	B	B^	B^	B^	B^	G^		C^	C^	C^	C^	C^	D^	D^	K^	D^	D^	D^	D^	D^	D^	
152	1500	S	B	B^	B^	B^	B	B^	B^	B^	B^	G^		C^	C^	C^	C^	C^	D^	D^	K^	D^	D^	D^	D^	D^	D^	
182	1800	S	B	B^	B^	B^	B	B^	B^	B^	B^	C^	G^	C^	C^	C^	C^	C^	D^	D^	K^	D^	D^	D^	D^	D^	D^	
222	2200	S	B	B^	B^	B^	B	B^	B^	B^	B^	D^	G^	C^	C^	C^	C^	C^	D^	D^	K^	D^	D^	D^	D^	D^	D^	
272	2700	S	B	B^	B^	B^	B	B^	B^	B^	B^	G^		C^	C^	C^	C^	C^	D^	D^	K^	D^	D^	D^	D^	D^	D^	
332	3300	S	B	B^	B^	B^	B	B^	B^	B^	B^	G^		C^	C^	C^	C^	D^	D^	K^	D^	D^	D^	D^	D^	D^	D^	K^
392	3900	S	B	B^	B^	B^	B	B^	B^	B^	B^	G^		C^	C^	C^	C^	D^	D^	K^	D^	D^	D^	D^	D^	D^	D^	K^
472	4700	S	B	B^	B^	B^	B	B^	B^	B^	B^			C^	C^	C^	C^	D^	D^	K^	D^	D^	D^	D^	D^	D^	D^	K^
562	5600	S	B	D^	D^	D^	B	B^	B^	B^	B^			C^	C^	C^	C^	K^	D^	D^	D^	D^	D^	D^	D^	D^	D^	
682	6800	S	B	D^	D^	D^	B	B^	B^	B^	B^			C^	C^	C^	C^	K^	D^	D^	D^	D^	D^	D^	D^	D^	D^	
822	8200	S	B	D^	D^	D^	B	B^	B^	B^	C^			C	C^	C^	C^	K^	D^	D^	D^	D^	D^	D^	D^	D^	D^	
103	0.01μF	S	B	D^	D^	D^	B	B^	B^	B^	C^			C	C^	C^	C^	K^	D^	D^	D^	D^	D^	D^	D^	D^	D^	
123	0.012		B				B	B^	B^	B^				C	C^	C^	C^		D^	D^	D^	D^	D^	D^	D^	D^	K^	
153	0.015		B				B	C^	C^	C^				C	C^	C^	C^		D^	D^	D^	D^	D^	D^	D^	D^	K^	
183	0.018		B				B	C^	C^	C^				C	C^	C^	C^		D^	D^	D^	D^	D^	D^	D^	D^	D^	
223	0.022		B				B	C^	C^	C^				C	C^	C^	D^		D^	D^	D^	D^	D^	D^	D^	D^	D^	
273	0.027		D				B	C^	C^	C^				C	C^	C^			D^	D^	D^	D^	D^	D^	D^	D^	D^	
333	0.033		D				B	G^	G^	G^				C	C^	C^			D^	D^	D^	D^	D^	D^	D^	D^	D^	
393	0.039						B	G^	G^	G^				C	C^	C^			D^	D^	D^	D^	D^	D^	D^	D^	D^	
473	0.047						B	G^	G^	G^				C	D^	D^			D^	D^	D^	D^	D^	D^	D^	D^	D^	
563	0.056						B							C	D^	D^			D^	D^	D^	D^	D^	D^	D^	D^	K^	
683	0.068						B							C					D^	D^	D^	D^	D^	D^	D^	D^	K^	
823	0.082						D							C					D	D^	D^	D^	D^	D^	D^	D^	K^	
104	0.1μF						D							C					D	D^	D^	D^	D^	D^	D^	D^	K^	
124	0.12													C					D	D^	D^							
154	0.15													D					D	K^	K^							
184	0.18													D					D	K^	K^							
224	0.22													D					D	K^	K^							
274	0.27																		D									
334	0.33																		D									
394	0.39																		D									
474	0.47																		K									
564	0.56																		K									
684	0.68																		K									
824	0.82																											
105	1μF																											

(1) [^]: The said items are made by NME (Noble Metal Electrode).

Size Unit:	Inch (mm)	0402 (1005)	0603 (1608)	0805 (2012)	1206 (3216)	1210 (3225)	1808 (4520)	1812 (4532)
A=	0.60±0.10 mm	-	-	Paper 4Kp/reel	-	-	-	-
B=	0.80±0.10 mm	-	-	Paper 4Kp/reel	Paper 4Kp/reel	-	-	-
C=	0.95±0.10 mm	-	-	-	Plastic 3Kp/reel	Plastic 3Kp/reel	-	-
D=	1.25±0.10 mm	-	-	Plastic 3Kp/reel	Plastic 3Kp/reel	Plastic 3Kp/reel	Plastic 2Kp/reel	Plastic 1Kp/reel
G=	1.60±0.20 mm	-	-	-	Plastic 2Kp/reel	Plastic 2Kp/reel	-	-
S=	0.80±0.07 mm	-	Paper 4Kp/reel	-	-	-	-	-
N=	0.50±0.05 mm	Paper 10Kp/reel	-	-	-	-	-	-
K=	2.00±0.20 mm	-	-	-	-	Plastic 2Kp/reel	Plastic 1Kp/reel	Plastic 1Kp/reel
M=	2.50±0.30 mm	-	-	-	-	Plastic 1Kp/reel	-	Plastic 1Kp/reel

Capacitance & Voltage (Y5V)

EIA Code	Size	0402					0603					0805					1206					1210				1812			
		6.3V	10V	16V	25V	50V	6.3V	10V	16V	25V	50V	6.3V	10V	16V	25V	50V	10V	16V	25V	35V	50V	10V	16V	25V	50V	10V	16V	25V	50V
102	1000pF																												
122	1200																												
152	1500																												
182	1800																												
222	2200																												
272	2700																												
332	3300																												
392	3900																												
472	4700																												
562	5600																												
682	6800																												
822	8200																												
103	0.01µF		N	N	N	N		S	S	S	S		A	A	A	A	B	B	B		B								
123	0.012		N	N	N	N		S	S	S	S		A	A	A	A	B	B	B		B								
153	0.015		N	N	N	N		S	S	S	S		A	A	A	A	B	B	B		B								
183	0.018		N	N	N	N		S	S	S	S		A	A	A	A	B	B	B		B								
223	0.022		N	N	N	N		S	S	S	S		A	A	A	A	B	B	B		B								
273	0.027		N	N	N	N		S	S	S	S		A	A	A	A	B	B	B		B								
333	0.033		N	N	N	N		S	S	S	S		A	A	A	A	B	B	B		B								
393	0.039		N	N	N			S	S	S	S		A	A	A	A	B	B	B		B								
473	0.047		N	N	N			S	S	S	S		A	A	A	A	B	B	B		B								
563	0.056		N	N				S	S	S	S		A	A	A	A	B	B	B		B								
683	0.068		N	N				S	S	S	S		A	A	A	A	B	B	B		B								
823	0.082		N	N				S	S	S	S		A	A	A	A	B	B	B		B								
104	0.1µF		N	N				S	S	S	S		A	A	A	A	B	B	B		B	C	C	C	C	D	D	D	D
154	0.15		N					S	S	S	S		A	A	A	A	B	B	B		B	C	C	C	C	D	D	D	D
224	0.22		N					S	S	S	S		A	A	A	A	B	B	B		B	C	C	C	C	D	D	D	D
334	0.33	N	N					S	S	S			B	B	B	B	B	B	B		B	C	C	C	C	D	D	D	D
474	0.47	N	N					S	S	S			B	B	B		B	B	B		B	C	C	C	C	D	D	D	D
684	0.68							S					B	B	D		B	B	B		B	C	C	C	C	D	D	D	D
105	1µF	N						S	S				B	B	D	D'	C	C	C		C	C	C	C	D	D	D	D	D
155	1.5												D	D			C	C	C		C	C	C		D	D	D	D	D
225	2.2						S						D	D			C	C	C		D'	C	C	C		D	D	D	D
335	3.3												D				D	D	D			C	C	C		D	D	D	D
475	4.7						S						D	D'			D	D	D'	D'		C	C	D	G	D	D	D	D
685	6.8																D	D'				C	C			D	D	D	D
106	10µF										D'	D'					D	D'				D	D	G		D	D	D	
226	22µF																G'					K	K						
476	47µF																					K							

(1) [D']: The thickness spec. of said items is special defined on 1.25±0.2mm for 0805 and 1.15±0.15mm for 1206.

(2) [G']: The thickness spec. of said items is special defined on 1.60+0.3/-0.1mm.

Size Unit: Inch (mm)	0402 (1005)	0603 (1608)	0805 (2012)	1206 (3216)	1210 (3225)	1808 (4520)	1812 (4532)
A= 0.60±0.10 mm	-	-	Paper 4Kp/reel	-	-	-	-
B= 0.80±0.10 mm	-	-	Paper 4Kp/reel	Paper 4Kp/reel	-	-	-
C= 0.95±0.10 mm	-	-	-	Plastic 3Kp/reel	Plastic 3Kp/reel	-	-
D= 1.25±0.10 mm	-	-	Plastic 3Kp/reel	Plastic 3Kp/reel	Plastic 3Kp/reel	Plastic 2Kp/reel	Plastic 1Kp/reel
G= 1.60±0.20 mm	-	-	-	Plastic 2Kp/reel	Plastic 2Kp/reel	-	-
S= 0.80±0.07 mm	-	Paper 4Kp/reel	-	-	-	-	-
N= 0.50±0.05 mm	Paper 10Kp/reel	-	-	-	-	-	-
K= 2.00±0.20 mm	-	-	-	-	Plastic 2Kp/reel	Plastic 1Kp/reel	Plastic 1Kp/reel

Capacitance & Voltage (Hi-Voltage Y5V)

EIA Code	Size VDCW	0805			1206			1210			1812		
		100	200	250	100	200	250	100	200	250	100	200	250
103	0.01µF	B	B	B	B	B	B	C	C	C	D	D	D
153	0.015	B	B	B	B	B	B	C	C	C	D	D	D
223	0.022	B	B	B	B	B	B	C	C	C	D	D	D
333	0.033	B	B	B	B	B	B	C	C	C	D	D	D
473	0.047	B	B	B	B	B	B	C	C	C	D	D	D
683	0.068	B	B	B	B	B	B	C	C	C	D	D	D
104	0.1µF	B			B	B	B	C	C	C	D	D	D
154	0.15				C	C	C	C	C	C	D	D	D
224	0.22				C			C			D	D	D
334	0.33							C			D	D	D
474	0.47										D	D	D
684	0.68										D	D	D
105	1µF										D		

Size Unit: Inch (mm)	0805 (2012)	1206 (3216)	1210 (3225)	1812 (4532)
A= 0.60±0.10 mm	Paper 4Kp/reel	-	-	-
B= 0.80±0.10 mm	Paper 4Kp/reel	Paper 4Kp/reel	-	-
C= 0.95±0.10 mm	-	Plastic 3Kp/reel	Plastic 3Kp/reel	-
D= 1.25±0.10 mm	Plastic 3Kp/reel	Plastic 3Kp/reel	Plastic 3Kp/reel	Plastic 1Kp/reel
G= 1.60±0.20 mm	-	Plastic 2Kp/reel	-	-
S= 0.80±0.07 mm	-	-	-	-
N= 0.50±0.05 mm	-	-	-	-
K= 2.00±0.20 mm	-	-	-	Plastic 1Kp/reel
M= 2.50±0.30 mm	-	-	-	-

Packaging

Chip Size	Paper Tape			Plastic Tape			Chip Thickness
	Width (reel)	Thickness	Unit/Reel	Width (reel)	Thickness	Unit/Reel	
0402	8mm (7")	N	10Kp/Reel				A=0.50~0.70
	8mm (7")	S	4Kp/Reel				B=0.85+0.05/-0.15
0603	8mm (10")	S	10Kp/Reel				C=1.00+0.05/-0.13
	8mm (13")	S	15Kp/Reel				D=1.20±0.15
	8mm (7")	A, B	4Kp/Reel	8mm (7")	C, D	3Kp/Reel	S=0.80±0.07
0805	8mm (10")	A, B	10Kp/Reel	8mm (10")	C, D	3Kp/Reel	H=0.50~0.60
	8mm (13")	A, B	15Kp/Reel	8mm (13")	C, D	3Kp/Reel	E=0.65~0.75
	8mm (7")	A, B	4Kp/Reel	8mm (7")	C, D	3Kp/Reel	N=0.50±0.05
1206	8mm (10")	A, B	10Kp/Reel	8mm (10")	C, D	3Kp/Reel	F=1.40+0.05/-0.15
	8mm (13")	A, B	15Kp/Reel	8mm (13")	C, D	3Kp/Reel	G=1.60+0.05/-0.15
				8mm (7")	F, G	3Kp/Reel	K=2.00±0.10
1210				8mm (7")	K	3Kp/Reel	
				8mm (7")	C, D	3Kp/Reel	
				8mm (7")	F	3Kp/Reel	
1808				12mm (7")	C, G	3Kp/Reel	
				12mm (7")	K	3Kp/Reel	
1812				12mm (7")	D	3Kp/Reel	

Packaging (continued)

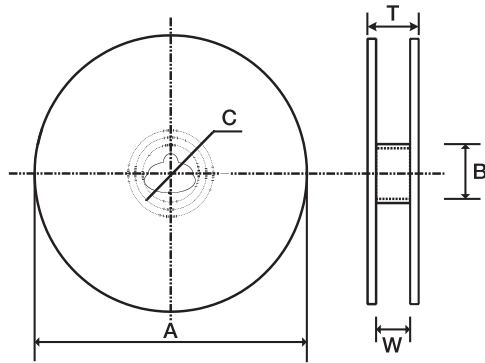

ϕA	ϕB	ϕC	W
178±1 (7")	60.5±1		9.0±1
	80±1		13.5±1
250±1 (10")	62.5±1	13.0±1	9.0±1
330±1 (13")	100±1		9.0±1

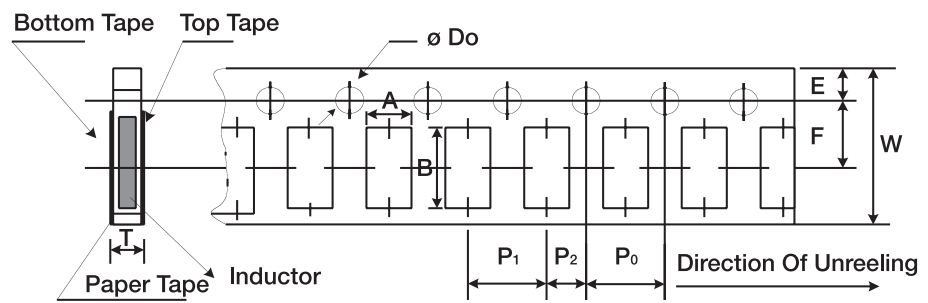

Type	A	B	W	ϕD_o	E	F	P_o	P_1	P_2	T
0402	0.7±0.05	1.23±0.05								0.6±0.05
0603	1.0±0.1	1.84±0.1	8.0±0.32	1.55±0.05	1.70±0.1	3.50±0.1	4.0±0.1	4.0±0.1	2.0±0.1	<1.0
0805	1.55±0.2	2.35±0.2								
1206	2.0±0.2	3.5±0.2								

How to Order

TYC	0201	A	101	B	C	T
Common Part	Size	Dielectric	Capacitance Code	Tolerance	Voltage	Packaging
TYC - Multilayer Ceramic Chip Capacitor	0201			B = 0.1pF C = 0.25pF D = 0.5pF F = +/- 1% G = +/- 2% J = +/- 5% K = +/- 10% M = +/- 20% Z = +80%/-20%	C = 6.3V D = 10V E = 16V F = 25V G = 50V H = 100V J = 200V L = 500V P = 1KV Q = 2KV R = 3KV S = 4KV	T = Paper (7") P = Plastic (7")
	0402	A = NPO B = X7R	101 - 100pF			
	0603	C = X5R	102 - 1000pF			
	0805	D = Y5V	103 - 0.01uF			
	1206					

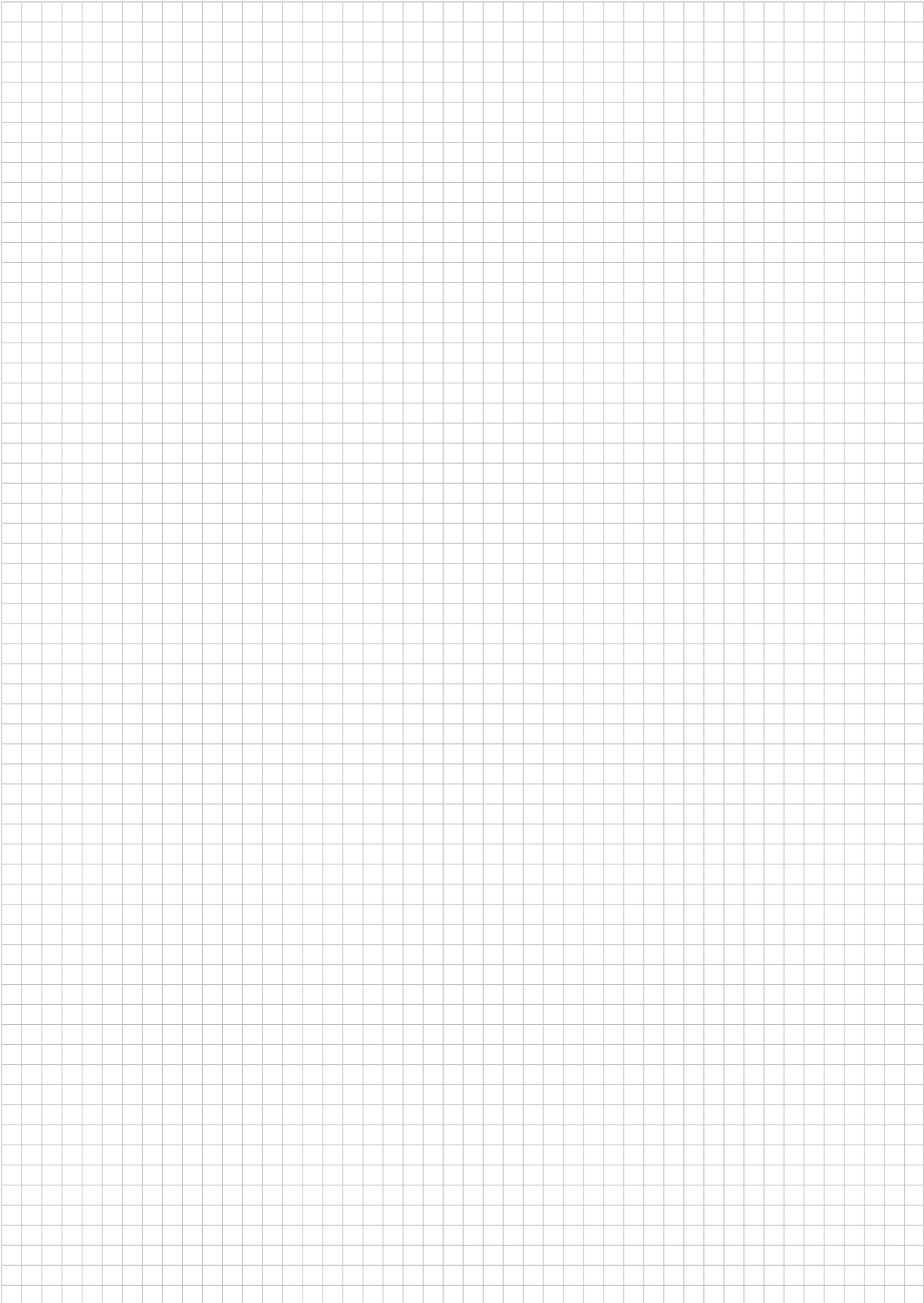

SMD Aluminium Electrolytic Capacitors – Product Overview

The TYE Range SMD V-Chip type Aluminium Electrolytic capacitors are designed for use throughout many industries in a broad range of applications.

The TYEV series is suitable for general purpose applications, the TYEH range is a high temperature version, up to 105 degrees Celsius, for use in more demanding situations.

The TYEE series provides low impedance and higher ripple current capabilities at extended temperatures from -55 to +105 degrees Celsius.

The TYEL series offers long service life and high temperature rating for increased reliability requirements.

The TYOH series is constructed from an Organic Conductive Polymer dielectric. This ensures ultra-low impedance and high ripple current ratings at extended temperatures for reliability under extreme conditions.

All are supplied on tape and reel for use with automatic placement equipment.

- Vertical-Chip type case style
- Tape and reel packaging
- 15" diameter reel size
- Suitable for high density PCB population
- Designed for reflow soldering
- RoHS compliant

Dielectric	Voltage Range	Capacitance Range	Temperature Range	Load Life	Series	Page
Aluminium Foil	6.3 to 50V	0.1 to 1000µF	-40 to +85°C	2000 hrs	TYEV	36
Aluminium Foil	6.3 to 100V	0.1 to 1000µF	-40 to +105°C	Up to 2000 hrs	TYEH	40
Aluminium Foil	6.3 to 35V	4.7 to 220µF	-55 to +105°C	1000 hrs	TYEE	44
Aluminium Foil	6.3 to 50V	0.1 to 1000µF	-40 to +105°C	3000 hrs	TYEL	46
Organic Conductive Polymer	2.5 to 25V	6.8 to 1500µF	-55 to +85°C	2000 hrs	TYOH	49

Type TYEV Series



Tyco Electronics vertical chip-type aluminum electrolytic capacitors are designed for surface mounting in high density PCB population. Supplied on tape and reel for use with automatic placement equipment. The TYEV series offers miniature case sizes for use where space is at a premium. Suitable for a broad range of general purpose filtering, bypassing and power supply decoupling applications.

Key Features

- General purpose surface mount aluminum electrolytic capacitors
- 85°C temperature rating
- 2000 hours load life assured
- Wide capacitance range
- Taped and Reeled
- 15" diameter reel size
- Designed for reflow soldering
- RoHS Compliant

Characteristics - Electrical

		Test Conditions JIS C5101-1,-18							
Operating Temp. Range	-40°C ~ +85°C	—							
Rated Voltage	DC 6.3 ~ 50V	85°C							
Capacitance	0.1~ 1000µF	85°C							
Capacitance Tolerance	±20%	120Hz, 20°C							
Leakage Current	0.01CV or 3µA whichever is greater	C = rated capacitance (µF) V = rated DC working voltage (V) Temperature = 20°C							
Dissipation Factor (Tanδ)	Rated Voltage	6.3	10	16	25	35	50	120Hz, 20°C	
		0.28	0.24	0.2	0.14	0.12	0.1		
Low Temperature Characteristics	Rated Voltage	6.3	10	16	25	35	50	120Hz	
	Impedance Ratio (max)								
	Z(-25°C)/Z(+20°C)	4	3	2	2	2	2		
Load Life Test	Test Time	2000 Hrs							Specification satisfied when the capacitors are restored to 20°C after the rated voltage applied with rated ripple current for 2000 hrs at 85°C
	Capacitance Change	Within 20% of initial value							
	Dissipation Factor	Less than 200% of specified value							
	Leakage Current	Within specified value							
Shelf Life Test	Test Time	1000 hrs							Other items same as those for load life test
Ripple Current & Multipliers Frequency	Frequency (Hz)	50	120	1k	10k and above			—	
	Multiplier ≤16VDC	0.8	1.0	1.15	1.25				
	Multiplier 25~35VDC	0.8	1.0	1.25	1.4				
	Multiplier 50VDC	0.8	1.0	1.35	1.5				

Product Availability Chart

Capacitance		Rated Voltage (V.DC)					
		6.3	10	16	25	35	50
µF	Code	Dia x L	Dia x L	Dia x L	Dia x L	Dia x L	Dia x L
0.1	104						4 x 5.3
0.22	224						4 x 5.3
0.33	334						4 x 5.3
0.47	474						4 x 5.3
1.0	105						4 x 5.3
2.2	225						4 x 5.3
3.3	335						4 x 5.3
4.7	475				4 x 5.3	4 x 5.3	4 x 5.3
							5 x 5.3
10	106			4 x 5.3	4 x 5.3	4 x 5.3	5 x 5.3
					5 x 5.3	5 x 5.3	6.3 x 5.3
22	226	4 x 5.3	4 x 5.3	4 x 5.3	5 x 5.3	5 x 5.3	6.3 x 5.3
				5 x 5.3	6.3 x 5.3	6.3 x 5.3	8 x 6.5
33	336	4 x 5.3	4 x 5.3	5 x 5.3	5 x 5.3	6.3 x 5.3	6.3 x 7.7
			5 x 5.3		6.3 x 5.3	8 x 6.5	8 x 6.5
47	476	4 x 5.3	6.3 x 5.3	5 x 5.3	6.3 x 5.3	6.3 x 5.3	6.3 x 7.7
		5 x 5.3		6.3 x 5.3		8 x 6.5	8 x 10
100	107	5 x 5.3	5 x 5.3	6.3 x 5.3	6.3 x 7.7	6.3 x 7.7	8 x 10
		6.3 x 5.3	6.3 x 5.3	8 x 6.5	8 x 6.5	8 x 10	10 x 10
220	227	6.3 x 5.3	6.3 x 7.7	6.3 x 7.7	8 x 10	8 x 10	10 x 10
			8 x 6.5	8 x 10		10 x 10	
330	337	6.3 x 7.7	8 x 10	8 x 10	8 x 10	10 x 10	
		8 x 6.5			10 x 10		
470	477	8 x 10	8 x 10	8 x 10	10 x 10		
			10 x 10	10 x 10			
1000	108	8 x 10	10 x 10				
		10 x 10					

Standard Product Table

Rated Voltage V.DC	Capacitance		Case Size Dia x L	Case Code	Dissipation Factor (%)*	Ripple Current (mA)*	Part Number
	µF	Code					
6.3	22	226	4 x 5.3	D55	28	23	TYEV0J226D55MTR
6.3	33	336	4 x 5.3	D55	28	31	TYEV0J336D55MTR
6.3	47	476	4 x 5.3	D55	28	37	TYEV0J476D55MTR
6.3	47	476	5 x 5.3	E55	28	50	TYEV0J476E55MTR
6.3	100	107	5 x 5.3	E55	28	63	TYEV0J107E55MTR
6.3	100	107	6.3 x 5.3	F55	28	98	TYEV0J107F55MTR
6.3	220	227	6.3 x 5.3	F55	28	110	TYEV0J227F55MTR
6.3	330	337	6.3 x 7.7	F80	28	139	TYEV0J337F80MTR
6.3	330	337	8 x 6.5	G68	28	155	TYEV0J337G68MTR
6.3	470	477	8 x 10	G10	28	252	TYEV0J477G10MTR
6.3	1000	108	8 x 10	G10	28	430	TYEV0J108G10MTR
6.3	1000	108	10 x 10	H10	28	458	TYEV0J108H10MTR
10	22	226	4 x 5.3	D55	24	26	TYEV1A226D55MTR
10	33	336	4 x 5.3	D55	24	33	TYEV1A336D55MTR
10	33	336	5 x 5.3	E55	24	48	TYEV1A336E55MTR
10	47	476	6.3 x 5.3	F55	24	67	TYEV1A476F55MTR
10	100	107	5 x 5.3	E55	24	65	TYEV1A107E55MTR
10	100	107	6.3 x 5.3	F55	24	110	TYEV1A107F55MTR
10	220	227	6.3 x 7.7	F80	24	130	TYEV1A227F80MTR
10	220	227	8 x 6.5	G68	24	155	TYEV1A227G68MTR
10	330	337	8 x 10	G10	24	252	TYEV1A337G10MTR
10	470	477	8 x 10	G10	24	280	TYEV1A477G10MTR
10	470	477	10 x 10	H10	24	458	TYEV1A477H10MTR
10	1000	108	10 x 10	H10	24	458	TYEV1A108H10MTR
16	10	106	4 x 5.3	D55	20	26	TYEV1C106D55MTR
16	22	226	4 x 5.3	D55	20	30	TYEV1C226D55MTR
16	22	226	5 x 5.3	E55	20	44	TYEV1C226E55MTR
16	33	336	5 x 5.3	E55	20	37	TYEV1C336E55MTR
16	47	476	5 x 5.3	E55	20	52	TYEV1C476E55MTR
16	47	476	6.3 x 5.3	F55	20	75	TYEV1C476F55MTR
16	100	107	6.3 x 5.3	F55	20	110	TYEV1C107F55MTR
16	100	107	8 x 6.5	G68	20	155	TYEV1C107G68MTR
16	220	227	6.3 x 7.7	F80	20	124	TYEV1C227F80MTR
16	220	227	8 x 10	G10	20	252	TYEV1C227G10MTR
16	330	337	8 x 10	G10	20	252	TYEV1C337G10MTR
16	470	477	8 x 10	G10	20	280	TYEV1C477G10MTR
16	470	477	10 x 10	H10	20	458	TYEV1C477H10MTR
25	4.7	475	4 x 5.3	D55	14	19	TYEV1E475D55MTR
25	10	106	4 x 5.3	D55	14	24	TYEV1E106D55MTR
25	10	106	5 x 5.3	E55	14	32	TYEV1E106E55MTR
25	22	226	5 x 5.3	E55	14	41	TYEV1E226E55MTR
25	22	226	6.3 x 5.3	F55	14	55	TYEV1E226F55MTR
25	33	336	5 x 5.3	E55	14	54	TYEV1E336E55MTR
25	33	336	6.3 x 5.3	F55	14	67	TYEV1E336F55MTR
25	47	476	6.3 x 5.3	F55	14	75	TYEV1E476F55MTR
25	100	107	6.3 x 7.7	F80	14	124	TYEV1E107F80MTR
25	100	107	8 x 6.5	G68	14	155	TYEV1E107G68MTR
25	220	227	8 x 10	G10	14	252	TYEV1E227G10MTR
25	330	337	8 x 10	G10	14	280	TYEV1E337G10MTR
25	330	337	10 x 10	H10	14	458	TYEV1E337H10MTR
25	470	477	10 x 10	H10	14	400	TYEV1E477H10MTR

* DF measured at 120Hz, 20°C

* RC measured at 120Hz, 85°C

Standard Product Table (continued)

Rated Voltage V.DC	Capacitance		Case Size Dia x L	Case Code	Dissipation Factor (%) [*]	Ripple Current (mA) [*]	Part Number
	μF	Code					
35	4.7	475	4 x 5.3	D55	12	20	TYEV1V475D55MTR
35	10	106	4 x 5.3	D55	12	27	TYEV1V106D55MTR
35	10	106	5 x 5.3	E55	12	34	TYEV1V106E55MTR
35	22	226	5 x 5.3	E55	12	47	TYEV1V226E55MTR
35	22	226	6.3 x 5.3	F55	12	59	TYEV1V226F55MTR
35	33	336	6.3 x 5.3	F55	12	67	TYEV1V336F55MTR
35	33	336	8 x 6.5	G68	12	155	TYEV1V336G68MTR
35	47	476	6.3 x 5.3	F55	12	64	TYEV1V476F55MTR
35	47	476	8 x 6.5	G68	12	155	TYEV1V476G68MTR
35	100	107	6.3 x 7.7	F80	12	120	TYEV1V107F80MTR
35	100	107	8 x 10	G10	12	252	TYEV1V107G10MTR
35	220	227	8 x 10	G10	12	280	TYEV1V227G10MTR
35	220	227	10 x 10	H10	12	458	TYEV1V227H10MTR
35	330	337	10 x 10	H10	12	360	TYEV1V337H10MTR
50	0.1	104	4 x 5.3	D55	10	3.0	TYEV1H104D55MTR
50	0.22	224	4 x 5.3	D55	10	5.0	TYEV1H224D55MTR
50	0.33	334	4 x 5.3	D55	10	6.0	TYEV1H334D55MTR
50	0.47	474	4 x 5.3	D55	10	7.0	TYEV1H474D55MTR
50	1.0	105	4 x 5.3	D55	10	10	TYEV1H105D55MTR
50	2.2	225	4 x 5.3	D55	10	15	TYEV1H225D55MTR
50	3.3	335	4 x 5.3	D55	10	19	TYEV1H335D55MTR
50	4.7	475	4 x 5.3	D55	10	20	TYEV1H475D55MTR
50	4.7	475	5 x 5.3	E55	10	26	TYEV1H475E55MTR
50	10	106	5 x 5.3	E55	10	34	TYEV1H106E55MTR
50	10	106	6.3 x 5.3	F55	10	44	TYEV1H106F55MTR
50	22	226	6.3 x 5.3	F55	10	59	TYEV1H226F55MTR
50	22	226	8 x 6.5	G68	10	155	TYEV1H226G68MTR
50	33	336	6.3 x 7.7	F80	10	82	TYEV1H336F80MTR
50	33	336	8 x 6.5	G68	10	155	TYEV1H336G68MTR
50	47	476	6.3 x 7.7	F80	10	98	TYEV1H476F80MTR
50	47	476	8 x 10	G10	10	252	TYEV1H476G10MTR
50	100	107	8 x 10	G10	10	252	TYEV1H107G10MTR
50	100	107	10 x 10	H10	10	458	TYEV1H107H10MTR
50	220	227	10 x 10	H10	10	458	TYEV1H227H10MTR

* DF measured at 120Hz, 20°C

* RC measured at 120Hz, 85°C

Dimensions

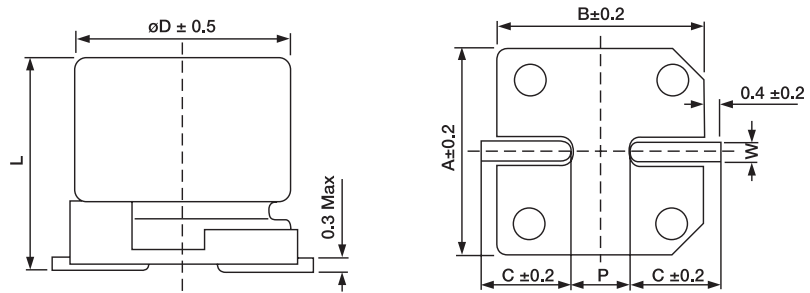

Case Code	Dimensions (mm)						
	Dia	L	A	B	C	W	P ± 0.2
D55	4.0	5.3 ± 0.3	4.3	4.3	2.0	0.5 to 0.8	1.0
E55	5.0	5.3 ± 0.3	5.3	5.3	2.3	0.5 to 0.8	1.5
F55	6.3	5.3 ± 0.3	6.6	6.6	2.7	0.5 to 0.8	2.0
F80	6.3	7.7 ± 0.3	6.6	6.6	2.7	0.5 to 0.8	2.0
G68	8.0	6.5 ± 0.3	8.4	8.4	3.4	0.5 to 0.8	2.3
G10	8.0	10 ± 0.5	8.4	8.4	3.0	0.7 to 1.1	3.1
H10	10	10 ± 0.5	10.4	10.4	3.3	0.7 to 1.1	4.7

How to Order

TYEV	0J	226	D55	M	TR
Common Part	Voltage Code	Capacitance	Case Code	Tolerance	Packaging
TYEV	0J (6.3V) 1A (10V) 1C (16V) 1E (25V) 1V (35V) 1H (50V)	e.g. 226	e.g. D55	M (20%)	TR = 15" Reels D55 Case - 2000pcs E55, F55, F80 and G68 Case - 1000pcs G10 and H10 Case - 500pcs

Type TYEH Series



Tyco Electronics vertical chip-type aluminum electrolytic capacitors are designed for surface mounting in high density PCB population. Supplied on tape and reel for use with automatic placement equipment. The TYEH series offers miniature case sizes with an extended temperature range (-40°C to +105°C) and voltage ratings up to 100V dc. Suitable for applications requiring reliability under more demanding conditions.

Key Features

- High temperature surface mount aluminum electrolytic capacitors
- 105°C temperature rating
- 1000 to 2000 hours load life assured
- Wide capacitance range
- Taped and Reeled
- 15" diameter reel size
- Designed for reflow soldering
- RoHS Compliant

Characteristics - Electrical

		Test Conditions JIS C5101-1,-18									
Operating Temp. Range	-40°C ~ +105°C	—									
Rated Voltage	DC 6.3 ~ 100V	105°C									
Capacitance	0.1 ~ 1000μF	105°C									
Capacitance Tolerance	±20%	120Hz, 20°C									
Leakage Current	0.01CV or 3μA whichever is greater	C = rated capacitance (μF) V = rated DC working voltage (V) Temperature = 20°C									
Dissipation Factor (Tanδ)	Rated Voltage	6.3	10	16	25	35	50	63	100	120Hz, 20°C	
	Case L = 5.3	0.3	0.3	0.22	0.16	0.13	0.12	-	-		
	Case L = 6.5~10										
	Case dia = 6.3	0.32	0.28	0.24	0.18	0.15	0.14	-	-		
	Case dia = 8~10	0.3	0.26	0.22	0.16	0.13	0.12	0.11	0.1		
Low Temperature Characteristics	Rated Voltage	6.3	10	16	25	35	50	63	100	120Hz	
	Impedance Ratio (max)										
	Z(-25°C)/Z(+20°C)	4	3	2	2	2	2	2	2		
	Z(-40°C)/Z(+20°C)	8	5	4	3	3	3	3	3		
Load Life Test Case L = 5.3	Test Time	1000 Hrs								Specification satisfied when the capacitors are restored to 20°C after the rated voltage applied for 1000 hrs at 105°C	
	Capacitance Change	Within ±20% of initial value									
	Dissipation Factor	Less than 200% of specified value									
	Leakage Current	Within specified value									
Load Life Test Case L = 6.5~10	Test Time	2000 Hrs								Specification satisfied when the capacitors are restored to 20°C after the rated voltage applied for 2000 hrs at 105°C	
	Capacitance Change										
	6.3V	Within ±30% of initial value									
	10~16V	Within ±25% of initial value									
	25~100V	Within ±20% of initial value									
	Dissipation Factor										
	6.3~16V	Less than 300% of specified value									
25~100V	Less than 200% of specified value										
Leakage Current	Within specified value										
Shelf Life Test	Test Time	1000 hrs								Other items same as those for load life test	
Ripple Current & Multipliers Frequency	Frequency (Hz)	50	120	1k	10k and above					—	
	Multiplier ≤16VDC	0.8	1.0	1.15	1.25						
	Multiplier 25~35VDC	0.8	1.0	1.25	1.4						
	Multiplier 50~63VDC	0.8	1.0	1.35	1.5						
	Multiplier 100VDC	0.7	1.0	1.35	1.5						

Product Availability Chart

Capacitance		Rated Voltage (V.DC)							
		6.3	10	16	25	35	50	63	100
µF	Code	Dia x L	Dia x L	Dia x L	Dia x L	Dia x L	Dia x L	Dia x L	Dia x L
0.1	104						4 x 5.3		
0.22	224						4 x 5.3		
0.33	334						4 x 5.3		
0.47	474						4 x 5.3		
1.0	105						4 x 5.3		
2.2	225						4 x 5.3		
3.3	335						4 x 5.3		
4.7	475				4 x 5.3	4 x 5.3	5 x 5.3		
10	106			4 x 5.3	5 x 5.3	5 x 5.3	6.3 x 5.3		8 x 10
22	226	4 x 5.3	5 x 5.3	5 x 5.3	6.3 x 5.3	6.3 x 5.3	8 x 6.5	8 x 10	8 x 10
									10 x 10
33	336	5 x 5.3	5 x 5.3	6.3 x 5.3	6.3 x 5.3	6.3 x 5.7	6.3 x 7.7	10 x 10	10 x 10
						8 x 6.5	8 x 10		
47	476	5 x 5.3	6.3 x 5.3	6.3 x 5.3	6.3 x 5.3	8 x 10	6.3 x 7.7	8 x 10	
					8 x 6.5		8 x 10	10 x 10	
100	107	6.3 x 5.3	6.3 x 5.3	6.3 x 5.3	6.3 x 7.7	8 x 10	8 x 10		
			8 x 6.5		8 x 10	10 x 10	10 x 10		
220	227		6.3 x 7.7	6.3 x 7.7	8 x 10	10 x 10	10 x 10		
			8 x 10	10 x 10	10 x 10				
330	337	8 x 10	8 x 10	8 x 10	10 x 10	10 x 10			
				10 x 10					
470	477	8 x 10	8 x 10	8 x 10	10 x 10				
			10 x 10	10 x 10					
1000	108	10 x 10	10 x 10						

Standard Product Table

Rated Voltage V.DC	Capacitance		Case Size Dia x L	Case Code	Dissipation Factor (%)*	Ripple Current (mA)*	Part Number
	µF	Code					
6.3	22	226	4 x 5.3	D55	30	21	TYEH0J226D55MTR
6.3	33	336	5 x 5.3	E55	30	30	TYEH0J336E55MTR
6.3	47	476	5 x 5.3	E55	30	36	TYEH0J476E55MTR
6.3	100	107	6.3 x 5.3	F55	30	61	TYEH0J107F55MTR
6.3	330	337	8 x 10	G10	30	178	TYEH0J337G10MTR
6.3	470	477	8 x 10	G10	30	210	TYEH0J477G10MTR
6.3	1000	108	10 x 10	H10	30	440	TYEH0J108H10MTR
10	22	226	5 x 5.3	E55	26	25	TYEH1A226E55MTR
10	33	336	5 x 5.3	E55	26	31	TYEH1A336E55MTR
10	47	476	6.3 x 5.3	F55	26	43	TYEH1A476F55MTR
10	100	107	6.3 x 5.3	F55	26	65	TYEH1A107F55MTR
10	100	107	8 x 6.5	G68	26	110	TYEH1A107G68MTR
10	220	227	6.3 x 7.7	F80	28	105	TYEH1A227F80MTR
10	220	227	8 x 10	G10	26	178	TYEH1A227G10MTR
10	330	337	8 x 10	G10	26	215	TYEH1A337G10MTR
10	470	477	8 x 10	G10	26	250	TYEH1A477G10MTR
10	470	477	10 x 10	H10	26	324	TYEH1A477H10MTR
10	1000	108	10 x 10	H10	26	440	TYEH1A108H10MTR
16	10	106	4 x 5.3	D55	22	16	TYEH1C106D55MTR
16	22	226	5 x 5.3	E55	22	28	TYEH1C226E55MTR
16	33	336	6.3 x 5.3	F55	22	40	TYEH1C336F55MTR
16	47	476	6.3 x 5.3	F55	22	47	TYEH1C476F55MTR
16	100	107	6.3 x 5.3	F55	22	70	TYEH1C107F55MTR

* DF measured at 120Hz, 20°C

* RC measured at 120Hz, 105°C

Standard Product Table (continued)

Rated Voltage V.DC	Capacitance		Case Size Dia x L	Case Code	Dissipation Factor (%)*	Ripple Current (mA)*	Part Number
	µF	Code					
16	220	227	6.3 x 7.7	F80	24	110	TYEH1C227F80MTR
16	220	227	10 x 10	H10	22	324	TYEH1C227H10MTR
16	330	337	8 x 10	G10	22	300	TYEH1C337G10MTR
16	330	337	10 x 10	H10	22	324	TYEH1C337H10MTR
16	470	477	8 x 10	G10	22	330	TYEH1C477G10MTR
16	470	477	10 x 10	H10	22	324	TYEH1C477H10MTR
25	4.7	475	4 x 5.3	D55	16	12	TYEH1E475D55MTR
25	10	106	5 x 5.3	E55	16	21	TYEH1E106E55MTR
25	22	226	6.3 x 5.3	F55	16	36	TYEH1E226F55MTR
25	33	336	6.3 x 5.3	F55	16	44	TYEH1E336F55MTR
25	47	476	6.3 x 5.3	F55	16	60	TYEH1E476F55MTR
25	47	476	8 x 6.5	G68	16	110	TYEH1E476G68MTR
25	100	107	6.3 x 7.7	F80	18	85	TYEH1E107F80MTR
25	100	107	8 x 10	G10	16	178	TYEH1E107G10MTR
25	220	227	8 x 10	G10	16	178	TYEH1E227G10MTR
25	220	227	10 x 10	H10	16	324	TYEH1E227H10MTR
25	330	337	10 x 10	H10	16	324	TYEH1E337H10MTR
25	470	477	10 x 10	H10	16	350	TYEH1E477H10MTR
35	4.7	475	4 x 5.3	D55	13	14	TYEH1V475D55MTR
35	10	106	5 x 5.3	E55	13	23	TYEH1V106E55MTR
35	22	226	6.3 x 5.3	F55	13	50	TYEH1V226F55MTR
35	33	336	6.3 x 5.7	F60	15	60	TYEH1V336F60MTR
35	33	336	8 x 6.5	G68	13	110	TYEH1V336G68MTR
35	47	476	8 x 10	G10	13	178	TYEH1V476G10MTR
35	100	107	8 x 10	G10	13	215	TYEH1V107G10MTR
35	100	107	10 x 10	H10	13	324	TYEH1V107H10MTR
35	220	227	10 x 10	H10	13	324	TYEH1V227H10MTR
35	330	337	10 x 10	H10	13	350	TYEH1V337H10MTR
50	0.1	104	4 x 5.3	D55	12	2.0	TYEH1H104D55MTR
50	0.22	224	4 x 5.3	D55	12	3.0	TYEH1H224D55MTR
50	0.33	334	4 x 5.3	D55	12	4.0	TYEH1H334D55MTR
50	0.47	474	4 x 5.3	D55	12	5.0	TYEH1H474D55MTR
50	1.0	105	4 x 5.3	D55	12	7.0	TYEH1H105D55MTR
50	2.2	225	4 x 5.3	D55	12	10	TYEH1H225D55MTR
50	3.3	335	4 x 5.3	D55	12	12	TYEH1H335D55MTR
50	4.7	475	5 x 5.3	E55	12	17	TYEH1H475E55MTR
50	10	106	6.3 X 5.3	F55	12	26	TYEH1H106F55MTR
50	22	226	8 x 6.5	G68	12	65	TYEH1H226G68MTR
50	33	336	6.3 x 7.7	F80	14	60	TYEH1H336F80MTR
50	33	336	8 x 10	G10	12	99	TYEH1H336G10MTR
50	47	476	6.3 x 7.7	F80	14	70	TYEH1H476F80MTR
50	47	476	8 x 10	G10	12	99	TYEH1H476G10MTR
50	100	107	8 x 10	G10	12	135	TYEH1H107G10MTR
50	100	107	10 x 10	H10	12	160	TYEH1H107H10MTR
50	220	227	10 x 10	H10	12	210	TYEH1H227H10MTR
63	22	226	8 x 10	G10	11	99	TYEH1J226G10MTR
63	33	336	10 x 10	H10	11	160	TYEH1J336H10MTR
63	47	476	8 x 10	G10	11	140	TYEH1J476G10MTR
63	47	476	10 x 10	H10	11	160	TYEH1J476H10MTR
100	10	106	8 x 10	G10	10	67	TYEH2A106G10MTR
100	22	226	8 x 10	G10	10	100	TYEH2A226G10MTR
100	22	226	10 x 10	H10	10	133	TYEH2A226H10MTR
100	33	336	10 x 10	H10	10	150	TYEH2A336H10MTR

* DF measured at 120Hz, 20°C

* RC measured at 120Hz, 105°C

Dimensions

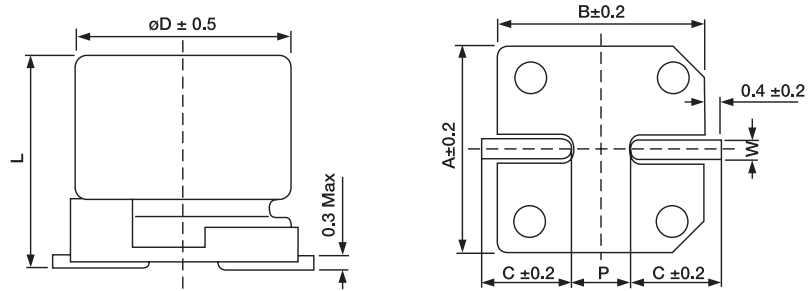

Case Code	Dimensions (mm)						
	Dia	L	A	B	C	W	P±0.2
D55	4.0	5.3±0.3	4.3	4.3	2.0	0.5 to 0.8	1.0
E55	5.0	5.3±0.3	5.3	5.3	2.3	0.5 to 0.8	1.5
F55	6.3	5.3±0.3	6.6	6.6	2.7	0.5 to 0.8	2.0
F80	6.3	7.7±0.3	6.6	6.6	2.7	0.5 to 0.8	2.0
G68	8.0	6.5±0.3	8.4	8.4	3.4	0.5 to 0.8	2.3
G10	8.0	10±0.5	8.4	8.4	3.0	0.7 to 1.1	3.1
H10	10	10±0.5	10.4	10.4	3.3	0.7 to 1.1	4.7

How to Order

TYEH	0J	226	D55	M	TR
Common Part	Voltage Code	Capacitance	Case Code	Tolerance	Packaging
TYEH	0J (6.3V) 1A (10V) 1C (16V) 1E (25V) 1V (35V) 1H (50V) 1J (63V) 2A (100V)	e.g. 226	e.g. D55	M (20%)	TR = 15" Reels D55 Case - 2000 pcs E55, F55, F80 and G68 Case - 1000 pcs G10 and H10 Case - 500 pcs

Type TYEE Series



Tyco Electronics vertical chip-type aluminum electrolytic capacitors are designed for surface mounting in high density PCB population.

Supplied on tape and reel for use with automatic placement equipment.

The TYEE series offers low impedance and higher ripple current for unit size. Extended temperature range (-55°C to +105°C) for use in applications where high reliability is required under extreme conditions.

Key Features

- Low impedance surface mount aluminum electrolytic capacitors
- 105°C temperature rating
- 1000 hours load life assured
- Taped and Reeled
- 15" diameter reel size
- Designed for reflow soldering
- RoHS Compliant

Characteristics - Electrical

		Test Conditions JIS C5101-1,-18					
Operating Temp. Range	-55°C ~ +105°C	—					
Rated Voltage	DC 6.3 ~ 35V	105°C					
Capacitance	4.7 ~ 220µF	105°C					
Capacitance Tolerance	±20%	120Hz, 20°C					
Leakage Current	0.01 CV or 3µA whichever is greater	C = rated capacitance (µF) V = rated DC working voltage (V) Temperature = 20°C					
Dissipation Factor (Tanδ)	Rated Voltage	6.3	10	16	25	35	120Hz, 20°C
	Tanδ max	0.28	0.24	0.20	0.16	0.14	
Low Temperature Characteristics	Rated Voltage	6.3	10	16	25	35	120Hz
	Impedance Ratio (max)						
	Z(-25°C)/Z(+20°C)	4	3	2	2	2	
Load Life Test	Test Time	1000 Hrs					Specification satisfied when the capacitors are restored to 20°C after the rated voltage applied with rated ripple current for 1000 hrs at 105°C
	Capacitance Change	Within ±25% of initial value					
	Dissipation Factor	Less than 200% of specified value					
	Leakage Current	Within specified value					
Shelf Life Test	Test Time	1000 hrs					Other items same as those for load life test
Ripple Current & Frequency Multipliers	Frequency (Hz)	50,60	120	1k	10k and above	—	
	Multiplier (VDC 6.3 ~ 50V)	0.64	0.8	0.93	1.0	—	

Product Availability Chart

Capacitance		Rated Voltage (V.DC)									
		6.3		10		16		25		35	
µF	Code	Dia x L	Imp.(Ω)	Dia x L	Imp.(Ω)	Dia x L	Imp.(Ω)	Dia x L	Imp.(Ω)	Dia x L	Imp.(Ω)
4.7	475									4x5.3	3.2
10	106					4x5.3	3.2	5x5.3	1.5	5x5.3	1.5
22	226	4x5.3	3.2	5x5.3	1.5	5x5.3	1.5	6.3x5.3	0.85	6.3x5.3	0.85
33	336	5x5.3	1.5	5x5.3	1.5	6.3x5.3	0.85	6.3x5.3	0.85	6.3x5.3	0.85
47	476	5x5.3	1.5	6.3x5.3	0.85	6.3x5.3	0.85	6.3x5.3	0.85	6.3x7.7	0.5
100	107	6.3x5.3	0.85	6.3x5.3	0.85	6.3x5.3	0.85	6.3x7.7	0.5		
150	157					6.3x7.7	0.5				
220	227	6.3x7.7	0.5								

Dimensions

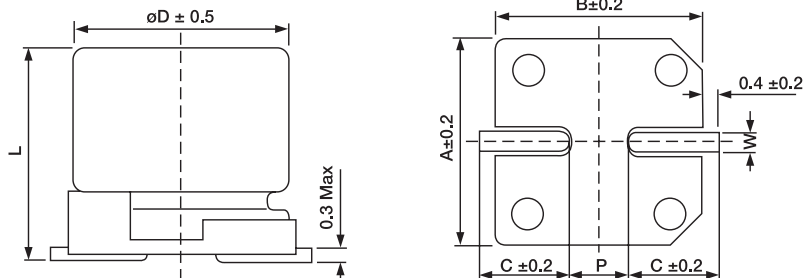

Case Code	Dimensions (mm)						
	Dia	L	A	B	C	W	P±0.2
D55	4.0	5.3±0.3	4.3	4.3	2.0	0.5 to 0.8	1.0
E55	5.0	5.3±0.3	5.3	5.3	2.3	0.5 to 0.8	1.5
F55	6.3	5.3±0.3	6.6	6.6	2.7	0.5 to 0.8	2.0
F80	6.3	7.7±0.3	6.6	6.6	2.7	0.5 to 0.8	2.0

Standard Product Table

Rated Voltage V.DC	Capacitance		Case Size Dia x L	Case Code	Dissipation Factor (%) [*]	Ripple Current (mA) [*]	Impedance (Ω) [*]	Part Number
	μF	Code						
6.3	22	226	4x5.3	D55	28	65	3.2	TYEE0J226D55MTR
6.3	33	336	5x5.3	E55	28	110	1.5	TYEE0J336E55MTR
6.3	47	476	5x5.3	E55	28	110	1.5	TYEE0J476E55MTR
6.3	100	107	6.3x5.3	F55	28	170	0.85	TYEE0J107F55MTR
6.3	220	227	6.3x7.7	F80	28	255	0.5	TYEE0J227F80MTR
10	22	226	5x5.3	E55	24	110	1.5	TYEE1A226E55MTR
10	33	336	5x5.3	E55	24	110	1.5	TYEE1A336E55MTR
10	47	476	6.3x5.3	F55	24	170	0.85	TYEE1A476F55MTR
10	100	107	6.3x5.3	F55	24	170	0.85	TYEE1A107F55MTR
16	10	106	4x5.3	D55	20	65	3.2	TYEE1C106D55MTR
16	22	226	5x5.3	E55	20	110	1.5	TYEE1C226E55MTR
16	33	336	6.3x5.3	F55	20	170	0.85	TYEE1C336F55MTR
16	47	476	6.3x5.3	F55	20	170	0.85	TYEE1C476F55MTR
16	100	107	6.3x5.3	F55	20	170	0.85	TYEE1C107F55MTR
16	150	157	6.3x7.7	F80	20	255	0.5	TYEE1C157F80MTR
25	10	106	5x5.3	E55	16	110	1.5	TYEE1E106E55MTR
25	22	226	6.3x5.3	F55	16	170	0.85	TYEE1E226F55MTR
25	33	336	6.3x5.3	F55	16	170	0.85	TYEE1E336F55MTR
25	47	476	6.3x5.3	F55	16	170	0.85	TYEE1E476F55MTR
25	100	107	6.3x7.7	F80	16	255	0.5	TYEE1E107F80MTR
35	4.7	475	4x5.3	D55	14	65	3.2	TYEE1V475D55MTR
35	10	106	5x5.3	E55	14	110	1.5	TYEE1V106E55MTR
35	22	226	6.3x5.3	F55	14	170	0.85	TYEE1V226F55MTR
35	33	336	6.3x5.3	F55	14	170	0.85	TYEE1V336F55MTR
35	47	476	6.3x7.7	F80	14	255	0.5	TYEE1V476F80MTR

* DF measured at 120Hz, 20°C

* RC measured at 100kHz, 105°C

* ESR measured at 100kHz, 20°C

How to Order

TYEE	0J	226	D55	M	TR
Common Part	Voltage Code	Capacitance	Case Code	Tolerance	Packaging
TYEE	0J (6.3V) 1A (10V) 1C (16V) 1E (25V) 1V (35V)	e.g. 226	e.g. D55	M (20%)	TR = 15" Reels D55 Case - 2000 pcs E55,F55 and F80 Case - 1000 pcs

Type TYEL Series



Tyco Electronics vertical chip-type aluminum electrolytic capacitors are designed for surface mounting in high density PCB population.

Supplied on tape and reel for use with automatic placement equipment.

The TYEL series offers long service life, guaranteed 3000 hours, over a wide operating temperature range (-40°C to +105°C) for use in applications where high reliability is required.

Key Features

- Long life surface mount aluminum electrolytic capacitors
- 105°C temperature rating
- 3000 hours load life assured
- Taped and Reeled
- 15" diameter reel size
- Designed for reflow soldering
- RoHS Compliant

Characteristics - Electrical

		Test Conditions JIS C5101-1,-18						
Operating Temp. Range	-40°C ~ +105°C	—						
Rated Voltage	DC 6.3 ~ 50V	105°C						
Capacitance	0.1 ~ 1000μF	105°C						
Capacitance Tolerance	±20%	120Hz, 20°C						
Leakage Current	0.01 CV or 3μA whichever is greater	C = rated capacitance (μF) V = rated DC working voltage (V) Temperature = 20°C						
Dissipation Factor (Tanδ)	Rated Voltage	6.3	10	16	25	35	50	120Hz, 20°C
	Tanδ max	0.3	0.24	0.2	0.16	0.13	0.12	
Low Temperature Characteristics	Rated Voltage	6.3	10	16	25	35	50	120Hz
	Impedance Ratio (max)							
	Z(-25°C)/Z(+20°C)	4	3	2	2	2	2	
Load Life Test	Test Time	3000 Hrs						Specification satisfied when the capacitors are restored to 20°C after the rated voltage applied with rated ripple current for 3000 hrs at 105°C
	Capacitance Change	Within 30% of initial value						
	Dissipation Factor	Less than 300% of specified value						
	Leakage Current	Within specified value						
Shelf Life Test	Test Time	1000 hrs						Other items same as those for load life test
Ripple Current & Multipliers Frequency	Frequency (Hz)	50	120	1k	10k and above			—
	Multiplier (VDC 6.3 ~ 50V)	0.7	1.0	1.36	1.5			

Product Availability Chart

Capacitance		Rated Voltage (V.DC)					
		6.3	10	16	25	35	50
μF	Code	Dia x L	Dia x L	Dia x L	Dia x L	Dia x L	Dia x L
0.1	104						4 x 5.7
0.22	224						4 x 5.7
0.33	334						4 x 5.7
0.47	474						4 x 5.7
1.0	105						4 x 5.7
2.2	225						4 x 5.7
3.3	335						4 x 5.7
4.7	475					4 x 5.7	5 x 5.7
10	106			4 x 5.7	5 x 5.7	5 x 5.7	6.3 x 5.7
22	226	4 x 5.7	5 x 5.7	5 x 5.7	6.3 x 5.7	6.3 x 5.7	6.3 x 7.7
33	336	5 x 5.7	5 x 5.7	6.3 x 5.7	6.3 x 5.7	6.3 x 7.7	8 x 10
47	476	5 x 5.7	6.3 x 5.7	6.3 x 5.7	6.3 x 7.7	8 x 10	8 x 10
100	107	6.3 x 5.7	6.3 x 7.7	6.3 x 7.7	8 x 10	10 x 10	10 x 10
220	227	6.3 x 7.7	8 x 10	10 x 10	10 x 10	10 x 10	
330	337	8 x 10	10 x 10	10 x 10	10 x 10		
470	477	10 x 10	10 x 10	10 x 10			
1000	108	10 x 10					

Standard Product Table

Rated Voltage V.DC	Capacitance		Case Size Dia x L	Case Code	Dissipation Factor (%)*	Ripple Current (mA)*	Part Number
	µF	Code					
6.3	22	226	4x5.7	D60	30	22	TYEL0J226D60MTR
6.3	33	336	5x5.7	E60	30	35	TYEL0J336E60MTR
6.3	47	476	5x5.7	E60	30	38	TYEL0J476E60MTR
6.3	100	107	6.3x5.7	F60	30	69	TYEL0J107F60MTR
6.3	220	227	6.3x7.7	F80	30	120	TYEL0J227F80MTR
6.3	330	337	8x10	G10	30	290	TYEL0J337G10MTR
6.3	470	477	10x10	H10	30	320	TYEL0J477H10MTR
6.3	1000	108	10x10	H10	30	410	TYEL0J108H10MTR
10	22	226	5x5.7	E60	24	30	TYEL1A226E60MTR
10	33	336	5x5.7	E60	24	35	TYEL1A336E60MTR
10	47	476	6.3x5.7	F60	24	50	TYEL1A476F60MTR
10	100	107	6.3x7.7	F80	24	81	TYEL1A107F80MTR
10	220	227	8x10	G10	24	141	TYEL1A227G10MTR
10	330	337	10x10	H10	24	290	TYEL1A337H10MTR
10	470	477	10x10	H10	24	320	TYEL1A477H10MTR
16	10	106	4x5.7	D60	20	18	TYEL1C106D60MTR
16	22	226	5x5.7	E60	20	30	TYEL1C226E60MTR
16	33	336	6.3x5.7	F60	20	48	TYEL1C336F60MTR
16	47	476	6.3x5.7	F60	20	50	TYEL1C476F60MTR
16	100	107	6.3x7.7	F80	20	81	TYEL1C107F80MTR
16	220	227	10x10	H10	20	216	TYEL1C227H10MTR
16	330	337	10x10	H10	20	290	TYEL1C337H10MTR
16	470	477	10x10	H10	20	320	TYEL1C477H10MTR
25	10	106	5x5.7	E60	16	27	TYEL1E106E60MTR
25	22	226	6.3x5.7	F60	16	44	TYEL1E226F60MTR
25	33	336	6.3x5.7	F60	16	50	TYEL1E336F60MTR
25	47	476	6.3x7.7	F80	16	63	TYEL1E476F80MTR
25	100	107	8x10	G10	16	141	TYEL1E107G10MTR
25	220	227	10x10	H10	16	290	TYEL1E227H10MTR
25	330	337	10x10	H10	16	320	TYEL1E337H10MTR
35	4.7	475	4x5.7	D60	13	16	TYEL1V475D60MTR
35	10	106	5x5.7	E60	13	27	TYEL1V106E60MTR
35	22	226	6.3x5.7	F60	13	44	TYEL1V226F60MTR
35	33	336	6.3x7.7	F80	13	57	TYEL1V336F80MTR
35	47	476	8x10	G10	13	141	TYEL1V476G10MTR
35	100	107	10x10	H10	13	290	TYEL1V107H10MTR
35	220	227	10x10	H10	13	320	TYEL1V227H10MTR
50	0.1	104	4x5.7	D60	12	1.0	TYEL1H104D60MTR
50	0.22	224	4x5.7	D60	12	2.6	TYEL1H224D60MTR
50	0.33	334	4x5.7	D60	12	3.2	TYEL1H334D60MTR
50	0.47	474	4x5.7	D60	12	5.0	TYEL1H474D60MTR
50	1.0	105	4x5.7	D60	12	8.0	TYEL1H105D60MTR
50	2.2	225	4x5.7	D60	12	12	TYEL1H225D60MTR
50	3.3	335	4x5.7	D60	12	17	TYEL1H335D60MTR
50	4.7	475	5x5.7	E60	12	22	TYEL1H475E60MTR
50	10	106	6.3x5.7	F60	12	32	TYEL1H106F60MTR
50	22	226	6.3x7.7	F80	12	58	TYEL1H226F80MTR
50	33	336	8x10	G10	12	130	TYEL1H336G10MTR
50	47	476	8x10	G10	12	141	TYEL1H476G10MTR
50	100	107	10x10	H10	12	310	TYEL1H107H10MTR

*DF measured at 120Hz, 20°C

* RC measured at 120Hz, 105°C

Dimensions

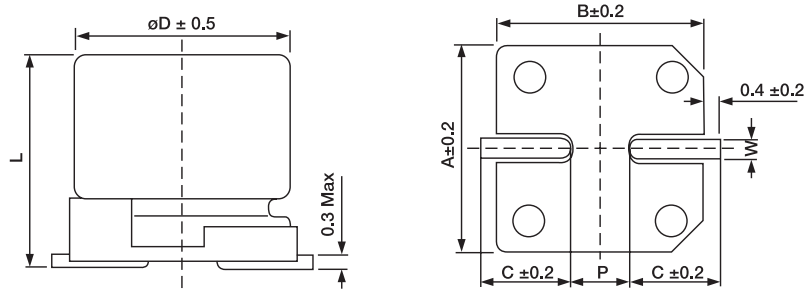

Case Code	Dimensions (mm)						
	Dia	L	A	B	C	W	P±0.2
D60	4.0	5.7±0.3	4.3	4.3	2.0	0.5 to 0.8	1.0
E60	5.0	5.7±0.3	5.3	5.3	2.3	0.5 to 0.8	1.5
F60	6.3	5.7±0.3	6.6	6.6	2.7	0.5 to 0.8	2.0
F80	6.3	7.7±0.3	6.6	6.6	2.7	0.5 to 0.8	2.0
G10	8.0	10±0.5	8.4	8.4	3.0	0.7 to 1.1	3.1
H10	10	10±0.5	10.4	10.4	3.3	0.7 to 1.1	4.7

How to Order

TYEL	0J	226	D60	M	TR
Common Part	Voltage Code	Capacitance	Case Code	Tolerance	Packaging
TYEL	0J (6.3V) 1A (10V) 1C (16V) 1E (25V) 1V (35V) 1H (50V)	e.g. 226	e.g. D60	M (20%)	TR = 15" Reels D60 Case - 2000pcs E60, F60 and F80 Case - 1000pcs G10 and H10 Case - 500pcs

Type TYOH Series



Tyco Electronics vertical chip-type aluminum electrolytic capacitors are designed for surface mounting in high density PCB population.

Supplied on tape and reel for use with automatic placement equipment.

The TYOH series are constructed from an Organic Conductive Polymer electrolyte. This offers ultra-low ESR and high ripple current handling capability over a wide operating temperature range (-55°C to +105°C). Designed for use in high frequency applications e.g. noise limiting circuits, switch mode power supplies, where high reliability is required under extreme conditions.

Key Features

- Organic conductive polymer surface mount aluminum electrolytic capacitors
- Ultra-low ESR
- High ripple current rating
- High frequency operation
- -55°C to +105°C temperature range
- 2000 hours load life assured
- Taped and Reeled
- 15" diameter reel size
- Designed for reflow soldering
- RoHS Compliant

Characteristics - Electrical

		Test Conditions JIS C5101-1,-18
Operating Temp. Range	-55°C ~ +105°C	—
Rated Voltage	DC 2.5 ~ 25V	105°C
Capacitance	6.8 ~ 1500μF	105°C
Capacitance Tolerance	±20%	120Hz, 20°C
Leakage Current	Not more than 0.2 CV (μA, after 2 minutes)	C = rated capacitance (μF) V = rated DC working voltage (V) Temperature = 20°C
Dissipation Factor (Tanδ)	See Standard Product Table	120Hz, 20°C
ESR	See Standard Product Table	100kHz to 300kHz, 20°C
Load Life Test	Test Time	2000 Hrs
	Capacitance Change	Within ±20% of initial value
	Dissipation Factor	Less than 150% of specified value
	ESR	Less than 150% of specified value
	Leakage Current	Within specified value
Moisture Resistance	Test Time	2000 Hrs
	Capacitance Change	Within ±20% of initial value
	Dissipation Factor	Less than 150% of specified value
	Leakage Current	Within specified value
		Store at 60°C, 90 to 95% R.H. Leakage current should be tested after voltage treatment

Product Availability Chart

Capacitance		Rated Voltage (V.DC)						
		2.5	4.0	6.3	10	16	20	25
μF	Code	Dia x L	Dia x L	Dia x L	Dia x L	Dia x L	Dia x L	Dia x L
6.8	685							6.3 x 6
22	226						6.3 x 6	
33	336							8 x 12
47	476					6.3 x 6	8 x 7	
56	566				6.3 x 6			10 x 13
82	826			6.3 x 6		8 x 7	10 x 8	
100	107			6.3 x 6			8 x 12	
120	127			6.3 x 7			10 x 10	
150	157		6.3 x 6	6.3 x 7	8 x 7		10 x 13	
180	187			8 x 7				
220	227					8 x 12		
		6.3 x 6	8 x 7	6.3 x 7		10 x 10		
330	337			8 x 7				
				10 x 8	8 x 12	10 x 13		
470	477				10 x 8			
				10 x 8	10 x 10			
560	567	8 x 7	8 x 12	10 x 10	10 x 13			
680	687	8 x 12	10 x 8					
820	827		10 x 10	10 x 13				
1000	108	10 x 8						
1200	128	10 x 10	10 x 13					
1500	158	10 x 13						

Standard Product Table

Rated Voltage V.DC	Capacitance		Case Size Dia x L	Case Code	Dissipation Factor (%)*	DC Leakage Current (µA)*	ESR (Ω)*	Ripple Current (mA)*	Part Number
	µF	Code							
2.5	220	227	6.3x6	F62	12	110	25	2500	TYOH0E227F62MTR
2.5	560	567	8x7	G72	12	280	23	3100	TYOH0E567G72MTR
2.5	680	687	8x12	G12	18	340	12	4770	TYOH0E687G12MTR
2.5	1000	108	10x8	H82	12	500	20	3800	TYOH0E108H82MTR
2.5	1200	128	10x10	H10	18	750	13	5200	TYOH0E128H10MTR
2.5	1500	158	10x13	H13	18	500	10	5500	TYOH0E158H13MTR
4.0	150	157	6.3x6	F62	12	120	26	2450	TYOH0G157F62MTR
4.0	220	227	8x7	G72	12	176	25	3020	TYOH0G227G72MTR
4.0	330	337	8x7	G72	12	264	25	3020	TYOH0G337G72MTR
4.0	470	477	10x8	H82	12	376	22	3800	TYOH0G477H82MTR
4.0	560	567	8x12	G12	18	448	12	4770	TYOH0G567G12MTR
4.0	680	687	10x8	H82	12	544	22	3800	TYOH0G687H82MTR
4.0	820	827	10x10	H10	18	656	13	5200	TYOH0G827H10MTR
4.0	1200	128	10x13	H13	18	960	10	5500	TYOH0G128H13MTR
6.3	82	826	6.3x6	F62	12	103	27	2400	TYOH0J826F62MTR
6.3	100	107	6.3x6	F62	12	126	27	2400	TYOH0J107F62MTR
6.3	120	127	6.3x7	F72	12	151	30	2010	TYOH0J127F72MTR
6.3	150	157	6.3x7	F72	12	189	30	2250	TYOH0J157F72MTR
6.3	150	157	8x7	G72	12	189	25	3020	TYOH0J157G72MTR
6.3	220	227	6.3x7	F72	12	277	45	2320	TYOH0J227F72MTR
6.3	220	227	8x7	G72	12	277	25	3020	TYOH0J227G72MTR
6.3	330	337	10x8	H82	12	416	22	3500	TYOH0J337H82MTR
6.3	470	477	8x12	G12	15	592	12	4770	TYOH0J477G12MTR
6.3	470	477	10x8	H82	12	592	22	3500	TYOH0J477H82MTR
6.3	560	567	10x10	H10	15	706	16	4700	TYOH0J567H10MTR
6.3	820	827	10x13	H13	15	1033	10	5500	TYOH0J827H13MTR
10	56	566	6.3x6	F62	10	112	31	2250	TYOH1A566F62MTR
10	150	157	8x7	G72	10	300	27	2800	TYOH1A157G72MTR
10	330	337	8x12	G12	15	660	14	4420	TYOH1A337G12MTR
10	330	337	10x8	H82	10	660	25	3200	TYOH1A337H82MTR
10	470	477	10x10	H10	15	940	18	4400	TYOH1A477H10MTR
10	560	567	10x13	H13	15	1360	12	5300	TYOH1A567H13MTR
16	47	476	6.3x6	F62	10	150	50	1650	TYOH1C476F62MTR
16	82	826	8x7	G72	10	262	30	2700	TYOH1C826G72MTR
16	180	187	8x12	G12	15	576	16	4360	TYOH1C187G12MTR
16	180	187	10x8	H82	10	576	33	3000	TYOH1C187H82MTR
16	220	227	10x10	H10	15	704	20	4200	TYOH1C227H10MTR
16	330	337	10x13	H13	15	1056	14	5050	TYOH1C337H13MTR
20	22	226	6.3x6	F62	10	88	50	1650	TYOH1D226F62MTR
20	47	476	8x7	G72	10	188	45	2000	TYOH1D476G72MTR
20	82	826	10x8	H82	10	328	40	2500	TYOH1D826H82MTR
20	100	107	8x12	G12	15	400	24	3320	TYOH1D107G12MTR
20	100	107	10x10	H10	15	400	25	3700	TYOH1D107H10MTR
20	150	157	10x13	H13	15	608	20	4320	TYOH1D157H13MTR
25	6.8	685	6.3x6	F62	10	170	80	1200	TYOH1E685F62MTR
25	33	336	8x12	G12	12	413	30	2980	TYOH1E336G12MTR
25	56	566	10x13	H13	12	700	28	3800	TYOH1E566H13MTR

* DF measured at 120Hz, 20°C

* DCL measured at 20°C

* ESR measured at 100kHz to 300kHz, 20°C

* RC measured at 100kHz, 105°C

Dimensions

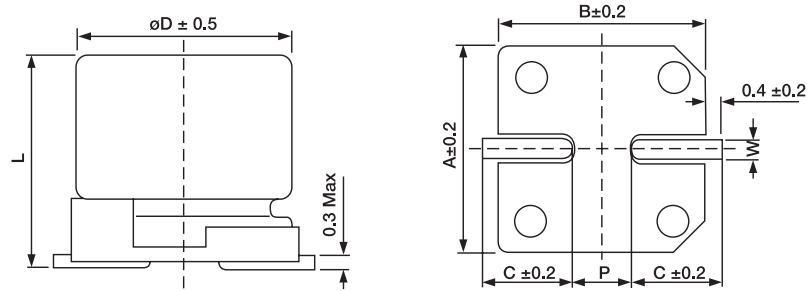

Case Code	Dimensions (mm)						
	Dia	L	A	B	C	W	P ± 0.2
F62	6.3	6.0 ± 0.2	6.6	6.6	2.7	0.5 to 0.8	2.0
F72	6.3	7.0 ± 0.2	6.6	6.6	2.7	0.5 to 0.8	2.0
G72	8.0	7.0 ± 0.2	8.4	8.4	3.0	0.7 to 1.1	3.1
G12	8.0	11.8 ± 0.5	8.4	8.4	3.0	0.7 to 1.1	3.1
H82	10	8.0 ± 0.2	10.4	10.4	3.3	0.7 to 1.1	4.7
H10	10	10 ± 0.5	10.4	10.4	3.3	0.7 to 1.1	4.7
H13	10	12.7 ± 0.5	10.4	10.4	3.3	0.7 to 1.1	4.7

How to Order

TYOH	0E	227	F62	M	TR
Common Part	Voltage Code	Capacitance	Case Code	Tolerance	Packaging
TYOH	0E (2.5V) 0G (4.0V) 0J (6.3V) 1A (10V) 1C (16V) 1D (20V) 1E (25V)	e.g. 227	e.g. F62	M (20%)	TR = 15" Reels F62, F72 and G72 Case - 1000pcs H82 and H10 Case - 500pcs G12 and H13 Case - 400pcs

Radial Leaded Aluminium Electrolytic Capacitors - Product Overview

The TYR Series Radial leaded Aluminium Electrolytic capacitors are designed for use throughout many industries in a broad range of through-hole PCB applications where board space is at a premium.

The TYRV range is suitable for general purpose applications, the TYRH range is a high temperature version, up to 105 degrees Celsius, for use in more demanding situations.

The TYRE range provides low impedance and higher ripple current capabilities at extended temperatures from -55 to +105 degrees Celsius.

The TYRL range offers long service life, up to 10000 hours, and high temperature rating for increased reliability requirements.

- Vertical mounting for high density PCB population
- Wide operating voltage range
- Broad range of capacitance values
- Low impedance and long life versions
- RoHS compliant

Voltage Range	Capacitance Range	Temperature Range	Load Life	Series	Page
6.3 to 450V	0.1 to 22000µF	-40 to +85°C	Up to 3000 hrs	TYRV	53
6.3 to 450V	0.1 to 22000µF	-40 to +105°C	Up to 2000 hrs	TYRH	60
6.3 to 100V	0.47 to 15000µF	-55 to +105°C	Up to 7000 hrs	TYRE	67
200 to 450V	4.7 to 330µF	-40 to +105°C	Up to 10000 hrs	TYRL	75

Type TYRV Series



Tyco Electronics radial leaded aluminum electrolytic capacitors are designed for through-hole PCB population where board space is restricted.

The TYRV series offers a wide capacitance range at voltages from 6.3 to 450Vd.c.

Suitable for a broad range of general purpose filtering, bypassing, power supply coupling/decoupling, telecommunications and audio-video applications.

Key Features

- General purpose polarized aluminum foil electrolytic capacitors
- Radial leads
- Aluminum case with insulating sleeve
- 85°C temperature rating
- 2000 to 3000 hours load life assured
- RoHS Compliant

Standard Product Table

Rated Voltage V.DC	Capacitance		Case Size Dia x L	Lead Pitch	Case Code	Dissipation Factor (%)*	Ripple Current (mA)*	Part Number
	µF	Code						
6.3	33	336	5x11	2.0	A11	23	72	TYRV0J336A11ML
6.3	47	476	5x11	2.0	A11	23	90	TYRV0J476A11ML
6.3	100	107	5x11	2.0	A11	23	130	TYRV0J107A11ML
6.3	220	227	5x11	2.0	A11	23	200	TYRV0J227A11ML
6.3	330	337	6.3x11	2.5	B11	23	270	TYRV0J337B11ML
6.3	470	477	6.3x11	2.5	B11	23	320	TYRV0J477B11ML
6.3	1000	108	8x11.5	3.5	C11	23	540	TYRV0J108C11ML
6.3	2200	228	10x20	5.0	D20	23	1000	TYRV0J228D20ML
6.3	3300	338	10x20	5.0	D20	23	1185	TYRV0J338D20ML
6.3	4700	478	12.5x20	5.0	E20	23	1545	TYRV0J478E20ML
6.3	6800	688	12.5x25	5.0	E25	23	1880	TYRV0J688E25ML
6.3	10000	109	16x25	7.5	F25	23	2330	TYRV0J109F25ML
6.3	22000	229	18x40	7.5	G40	23	3320	TYRV0J229G40ML
6.3	22000	229	22x40	10	H40	23	3700	TYRV0J229H40ML
10	22	226	5x11	2.0	A11	20	70	TYRV1A226A11ML
10	33	336	5x11	2.0	A11	20	84	TYRV1A336A11ML
10	47	476	5x11	2.0	A11	20	100	TYRV1A476A11ML
10	100	107	5x11	2.0	A11	20	145	TYRV1A107A11ML
10	220	227	6.3x11	2.5	B11	20	250	TYRV1A227B11ML
10	330	337	6.3x11	2.5	B11	20	290	TYRV1A337B11ML
10	470	477	6.3x11	2.5	B11	20	350	TYRV1A477B11ML
10	1000	108	10x12.5	5.0	D12	20	650	TYRV1A108D12ML
10	2200	228	10x20	5.0	D20	20	1070	TYRV1A228D20ML
10	3300	338	12.5x20	5.0	E20	20	1420	TYRV1A338E20ML
10	4700	478	12.5x25	5.0	E25	20	1780	TYRV1A478E25ML
10	6800	688	16x25	7.5	F25	20	2220	TYRV1A688F25ML
10	10000	109	16x35.5	7.5	F35	20	2670	TYRV1A109F35ML
10	22000	229	22x40	10	H40	20	3790	TYRV1A229H40ML
16	10	106	5x11	2.0	A11	16	49	TYRV1C106A11ML
16	22	226	5x11	2.0	A11	16	75	TYRV1C226A11ML
16	33	336	5x11	2.0	A11	16	90	TYRV1C336A11ML
16	47	476	5x11	2.0	A11	16	110	TYRV1C476A11ML
16	100	107	5x11	2.0	A11	16	160	TYRV1C107A11ML
16	220	227	6.3x11	2.5	B11	16	260	TYRV1C227B11ML
16	330	337	8x11.5	3.5	C11	16	370	TYRV1C337C11ML
16	470	477	8x11.5	3.5	C11	16	440	TYRV1C477C11ML
16	1000	108	10x16	5.0	D16	16	785	TYRV1C108D16ML
16	2200	228	12.5x20	5.0	E20	16	1295	TYRV1C228E20ML
16	3300	338	12.5x25	5.0	E25	16	1655	TYRV1C338E25ML
16	4700	478	16x25	7.5	F25	16	2090	TYRV1C478F25ML
16	6800	688	16x31.5	7.5	F31	16	2520	TYRV1C688F31ML
16	10000	109	18x35.5	7.5	G35	16	2920	TYRV1C109G35ML
16	22000	229	22x40	10	H40	16	3900	TYRV1C229H40ML
25	4.7	475	5x11	2.0	A11	14	31	TYRV1E475A11ML
25	10	106	5x11	2.0	A11	14	54	TYRV1E106A11ML
25	22	226	5x11	2.0	A11	14	80	TYRV1E226A11ML
25	33	336	5x11	2.0	A11	14	97	TYRV1E336A11ML
25	47	476	5x11	2.0	A11	14	115	TYRV1E476A11ML
25	100	107	6.3x11	2.5	B11	14	190	TYRV1E107B11ML
25	220	227	8x11.5	3.5	C11	14	320	TYRV1E227C11ML
25	330	337	8x11.5	3.5	C11	14	440	TYRV1E337C11ML

* DF measured at 120Hz, 20°C

* RC measured at 120Hz, 85°C

Standard Product Table (continued)

Rated Voltage V.DC	Capacitance		Case Size Dia x L	Lead Pitch	Case Code	Dissipation Factor (%)*	Ripple Current (mA)*	Part Number
	µF	Code						
25	330	337	10x12.5	5.0	D12	14	470	TYRV1E337D12ML
25	470	477	10x12.5	5.0	D12	14	545	TYRV1E477D12ML
25	1000	108	10x20	5.0	D20	14	955	TYRV1E108D20ML
25	2200	228	12.5x25	5.0	E25	14	1540	TYRV1E228E25ML
25	3300	338	16x25	7.5	F25	14	1975	TYRV1E338F25ML
25	4700	478	16x31.5	7.5	F31	14	2420	TYRV1E478F31ML
25	6800	688	18x35.5	7.5	G35	14	2880	TYRV1E688G35ML
25	10000	109	22x40	10	H40	14	3440	TYRV1E109H40ML
35	4.7	475	5x11	2.0	A11	12	40	TYRV1V475A11ML
35	10	106	5x11	2.0	A11	12	58	TYRV1V106A11ML
35	22	226	5x11	2.0	A11	12	87	TYRV1V226A11ML
35	33	336	5x11	2.0	A11	12	108	TYRV1V336A11ML
35	47	476	5x11	2.0	A11	12	130	TYRV1V476A11ML
35	100	107	6.3x11	2.5	B11	12	210	TYRV1V107B11ML
35	220	227	8x11.5	3.5	C11	12	385	TYRV1V227C11ML
35	220	227	10x12.5	5.0	D12	12	420	TYRV1V227D12ML
35	330	337	10x12.5	5.0	D12	12	490	TYRV1V337D12ML
35	470	477	10x16	5.0	D16	12	740	TYRV1V477D16ML
35	1000	108	12.5x20	5.0	E20	12	1145	TYRV1V108E20ML
35	2200	228	16x25	7.5	F25	12	1785	TYRV1V228F25ML
35	3300	338	16x35.5	7.5	F35	12	2275	TYRV1V338F35ML
35	4700	478	18x35.5	7.5	G35	12	2700	TYRV1V478G35ML
50	0.1	104	5x11	2.0	A11	10	1.5	TYRV1H104A11ML
50	0.22	224	5x11	2.0	A11	10	3.5	TYRV1H224A11ML
50	0.33	334	5x11	2.0	A11	10	5.0	TYRV1H334A11ML
50	0.47	474	5x11	2.0	A11	10	7.0	TYRV1H474A11ML
50	1.0	105	5x11	2.0	A11	10	15	TYRV1H105A11ML
50	2.2	225	5x11	2.0	A11	10	29	TYRV1H225A11ML
50	3.3	335	5x11	2.0	A11	10	35	TYRV1H335A11ML
50	4.7	475	5x11	2.0	A11	10	42	TYRV1H475A11ML
50	10	106	5x11	2.0	A11	10	65	TYRV1H106A11ML
50	22	226	5x11	2.0	A11	10	95	TYRV1H226A11ML
50	33	336	5x11	2.0	A11	10	125	TYRV1H336A11ML
50	47	476	6.3x11	2.5	B11	10	165	TYRV1H476B11ML
50	100	107	8x11.5	3.5	C11	10	260	TYRV1H107C11ML
50	220	227	10x12.5	5.0	D12	10	455	TYRV1H227D12ML
50	330	337	10x16	5.0	D16	10	585	TYRV1H337D16ML
50	470	477	10x20	5.0	D20	10	755	TYRV1H477D20ML
50	1000	108	12.5x25	5.0	E25	10	1340	TYRV1H108E25ML
50	2200	228	16x35.5	7.5	F35	10	2075	TYRV1H228F35ML
50	3300	338	18x35.5	7.5	G35	10	2500	TYRV1H338G35ML
50	3300	338	22x40	10	H40	10	2785	TYRV1H338H40ML
50	4700	478	22x40	10	H40	10	3155	TYRV1H478H40ML
50	4700	478	25x40	12.5	J40	10	3300	TYRV1H478J40ML
63	10	106	5x11	2.0	A11	9	70	TYRV1J106A11ML
63	22	226	6.3x11	2.5	B11	9	115	TYRV1J226B11ML
63	33	336	6.3x11	2.5	B11	9	140	TYRV1J336B11ML
63	47	476	6.3x11	2.5	B11	9	170	TYRV1J476B11ML
63	100	107	10x12.5	5.0	D12	9	320	TYRV1J107D12ML
63	220	227	10x16	5.0	D16	9	490	TYRV1J227D16ML

* DF measured at 120Hz, 20°C

* RC measured at 120Hz, 85°C

Standard Product Table (continued)

Rated Voltage V.DC	Capacitance		Case Size Dia x L	Lead Pitch	Case Code	Dissipation Factor (%)*	Ripple Current (mA)*	Part Number
	µF	Code						
63	330	337	10x20	5.0	D20	9	710	TYRV1J337D20ML
63	470	477	12.5x20	5.0	E20	9	900	TYRV1J477E20ML
63	1000	108	16x25	7.5	F25	9	1560	TYRV1J108F25ML
63	2200	228	18x40	7.5	G40	9	2385	TYRV1J228G40ML
63	3300	338	22x40	10	H40	9	3000	TYRV1J338H40ML
63	4700	478	25x40	12.5	J40	9	3560	TYRV1J478J40ML
100	0.1	104	5x11	2.0	A11	8	3.0	TYRV2A104A11ML
100	0.22	224	5x11	2.0	A11	8	5.8	TYRV2A224A11ML
100	0.33	334	5x11	2.0	A11	8	8.8	TYRV2A334A11ML
100	0.47	474	5x11	2.0	A11	8	12	TYRV2A474A11ML
100	1.0	105	5x11	2.0	A11	8	22	TYRV2A105A11ML
100	2.2	225	5x11	2.0	A11	8	33	TYRV2A225A11ML
100	3.3	335	5x11	2.0	A11	8	40	TYRV2A335A11ML
100	4.7	475	5x11	2.0	A11	8	48	TYRV2A475A11ML
100	10	106	6.3x11	2.5	B11	8	80	TYRV2A106B11ML
100	22	226	6.3x11	2.5	B11	8	115	TYRV2A226B11ML
100	33	336	8x11.5	3.5	C11	8	145	TYRV2A336C11ML
100	47	476	10x12.5	5.0	D12	8	235	TYRV2A476D12ML
100	100	107	10x20	5.0	D20	8	370	TYRV2A107D20ML
100	220	227	12.5x20	5.0	E20	8	640	TYRV2A227E20ML
100	330	337	16x25	7.5	F25	8	825	TYRV2A337F25ML
100	470	477	16x31.5	7.5	F31	8	1070	TYRV2A477F31ML
100	1000	108	18x40	7.5	G40	8	2410	TYRV2A108G40ML
160	0.47	474	6.3x11	2.5	B11	12	15	TYRV2C474B11ML
160	1.0	105	6.3x11	2.5	B11	12	24	TYRV2C105B11ML
160	2.2	225	6.3x11	2.5	B11	12	34	TYRV2C225B11ML
160	3.3	335	6.3x11	2.5	B11	12	43	TYRV2C335B11ML
160	4.7	475	6.3x11	2.5	B11	12	51	TYRV2C475B11ML
160	10	106	10x12.5	5.0	D12	12	104	TYRV2C106D12ML
160	22	226	10x20	5.0	D20	12	189	TYRV2C226D20ML
160	33	336	10x20	5.0	D20	12	228	TYRV2C336D20ML
160	47	476	12.5x20	5.0	E20	12	318	TYRV2C476E20ML
160	100	107	12.5x25	5.0	E25	12	510	TYRV2C107E25ML
160	220	227	16x31.5	7.5	F31	12	792	TYRV2C227F31ML
160	330	337	18x35.5	7.5	G35	12	984	TYRV2C337G35ML
200	0.47	474	6.3x11	2.5	B11	14	16	TYRV2D474B11ML
200	1.0	105	6.3x11	2.5	B11	14	25	TYRV2D105B11ML
200	2.2	225	6.3x11	2.5	B11	14	37	TYRV2D225B11ML
200	3.3	335	6.3x11	2.5	B11	14	46	TYRV2D335B11ML
200	4.7	475	8x11.5	3.5	C11	14	64	TYRV2D475C11ML
200	10	106	10x12.5	5.0	D12	14	112	TYRV2D106D12ML
200	22	226	10x20	5.0	D20	14	204	TYRV2D226D20ML
200	33	336	12.5x20	5.0	E20	14	288	TYRV2D336E20ML
200	47	476	12.5x25	5.0	E25	14	378	TYRV2D476E25ML
200	100	107	16x25	7.5	F25	14	582	TYRV2D107F25ML
200	220	227	18x35.5	7.5	G35	14	1002	TYRV2D227G35ML
250	2.2	225	6.3x11	2.5	B11	17	42	TYRV2E225B11ML
250	3.3	335	8x11.5	3.5	C11	17	60	TYRV2E335C11ML
250	4.7	475	8x11.5	3.5	C11	17	72	TYRV2E475C11ML
250	10	106	10x16	5.0	D16	17	138	TYRV2E106D16ML

* DF measured at 120Hz, 20°C

* RC measured at 120Hz, 85°C

Standard Product Table (continued)

Rated Voltage V.DC	Capacitance		Case Size Dia x L	Lead Pitch	Case Code	Dissipation Factor (%) [*]	Ripple Current (mA) [*]	Part Number
	µF	Code						
250	22	226	10 x 20	5.0	D20	17	220	TYRV2E226D20ML
250	33	336	12.5 x 20	5.0	E20	17	310	TYRV2E336E20ML
250	47	476	12.5 x 25	5.0	E25	17	420	TYRV2E476E25ML
250	100	107	16 x 35.5	7.5	F35	17	732	TYRV2E107F35ML
250	220	227	22 x 40	10	H40	17	1134	TYRV2E227H40ML
350	1.0	105	6.3 x 11	2.5	B11	20	27	TYRV2V105B11ML
350	2.2	225	8 x 11.5	3.5	C11	20	49	TYRV2V225C11ML
350	3.3	335	10 x 12.5	5.0	D12	20	70	TYRV2V335D12ML
350	4.7	475	10 x 16	5.0	D16	20	93	TYRV2V475D16ML
350	10	106	10 x 20	5.0	D20	20	150	TYRV2V106D20ML
350	22	226	12.5 x 20	5.0	E20	20	255	TYRV2V226E20ML
350	33	336	16 x 25	7.5	F25	20	390	TYRV2V336F25ML
350	47	476	16 x 31.5	7.5	F31	20	474	TYRV2V476F31ML
350	100	107	18 x 40	7.5	G40	20	685	TYRV2V107G40ML
400	1.0	105	8 x 11.5	3.5	C11	25	32	TYRV2G105C11ML
400	2.2	225	10 x 12.5	5.0	D12	25	57	TYRV2G225D12ML
400	3.3	335	10 x 16	5.0	D16	25	78	TYRV2G335D16ML
400	4.7	475	10 x 20	5.0	D20	25	103	TYRV2G475D20ML
400	10	106	12.5 x 20	5.0	E20	25	174	TYRV2G106E20ML
400	22	226	12.5 x 25	5.0	E25	25	280	TYRV2G226E25ML
400	22	226	16 x 25	7.5	F25	25	318	TYRV2G226F25ML
400	33	336	16 x 25	7.5	F25	25	390	TYRV2G336F25ML
400	47	476	16 x 31.5	7.5	F31	25	474	TYRV2G476F31ML
400	100	107	22 x 40	10	H40	25	710	TYRV2G107H40ML
450	1.0	105	8 x 11.5	3.5	C11	25	32	TYRV2W105C11ML
450	2.2	225	10 x 12.5	5.0	D12	25	57	TYRV2W225D12ML
450	3.3	335	10 x 16	5.0	D16	25	78	TYRV2W335D16ML
450	4.7	475	10 x 20	5.0	D20	25	103	TYRV2W475D20ML
450	10	106	12.5 x 20	5.0	E20	25	174	TYRV2W106E20ML
450	22	226	16 x 25	7.5	F25	25	354	TYRV2W226F25ML
450	33	336	16 x 31.5	7.5	F31	25	435	TYRV2W336F31ML
450	47	476	18 x 40	7.5	G40	25	600	TYRV2W476G40ML
450	100	107	22 x 45	10	H45	25	750	TYRV2W107H45ML

* DF measured at 120Hz, 20°C

* RC measured at 120Hz, 85°C

Product Availability Chart

Capacitance		Rated Voltage (V.DC)													
		6.3		10		16		25		35		50		63	
µF	Code	Dia x L	P	Dia x L	P	Dia x L	P	Dia x L	P	Dia x L	P	Dia x L	P	Dia x L	P
0.1	104											5x11	2.0		
0.22	224											5x11	2.0		
0.33	334											5x11	2.0		
0.47	474											5x11	2.0		
1.0	105											5x11	2.0		
2.2	225											5x11	2.0		
3.3	335											5x11	2.0		
4.7	475							5x11	2.0	5x11	2.0	5x11	2.0		
10	106					5x11	2.0	5x11	2.0	5x11	2.0	5x11	2.0	5x11	2.0
22	226			5x11	2.0	5x11	2.0	5x11	2.0	5x11	2.0	5x11	2.0	6.3x11	2.5
33	336	5x11	2.0	5x11	2.0	5x11	2.0	5x11	2.0	5x11	2.0	5x11	2.0	6.3x11	2.5
47	476	5x11	2.0	5x11	2.0	5x11	2.0	5x11	2.0	5x11	2.0	6.3x11	2.5	6.3x11	2.5
100	107	5x11	2.0	5x11	2.0	5x11	2.0	6.3x11	2.5	6.3x11	2.5	8x11.5	3.5	10x12.5	5.0
220	227	5x11	2.0	6.3x11	2.5	6.3x11	2.5	8x11.5	3.5	8x11.5	3.5	10x12.5	5.0	10x16	5.0
330	337	6.3x11	2.5	6.3x11	2.5	8x11.5	3.5	8x11.5	3.5	10x12.5	5.0	10x16	5.0	10x20	5.0
470	477	6.3x11	2.5	6.3x11	2.5	8x11.5	3.5	10x12.5	5.0	10x16	5.0	10x20	5.0	12.5x20	5.0
1000	108	8x11.5	3.5	10x12.5	5.0	10x16	5.0	10x20	5.0	12.5x20	5.0	12.5x25	5.0	16x25	7.5
2200	228	10x20	5.0	10x20	5.0	12.5x20	5.0	12.5x25	5.0	16x25	7.5	16x35.5	7.5	18x40	7.5
3300	338	10x20	5.0	12.5x20	5.0	12.5x25	5.0	16x25	7.5	16x35.5	7.5	18x35.5	7.5	22x40	10
4700	478	12.5x20	5.0	12.5x25	5.0	16x25	7.5	16x31.5	7.5	18x35.5	7.5	22x40	10	25x40	12.5
6800	688	12.5x25	5.0	16x25	7.5	16x31.5	7.5	18x35.5	7.5						
10000	109	16x25	7.5	16x35.5	7.5	18x35.5	7.5	22x40	10						
22000	229	18x40	7.5	22x40	10	22x40	10								
		22x40	10												

Capacitance		Rated Voltage (V.DC)													
		100		160		200		250		350		400		450	
µF	Code	Dia x L	P	Dia x L	P	Dia x L	P	Dia x L	P	Dia x L	P	Dia x L	P	Dia x L	P
0.1	104	5x11	2.0												
0.22	224	5x11	2.0												
0.33	334	5x11	2.0												
0.47	474	5x11	2.0	6.3x11	2.5	6.3x11	2.5								
1.0	105	5x11	2.0	6.3x11	2.5	6.3x11	2.5			6.3x11	2.5	8x11.5	3.5	8x11.5	3.5
2.2	225	5x11	2.0	6.3x11	2.5	6.3x11	2.5	6.3x11	2.5	8x11.5	3.5	10x12.5	5.0	10x12.5	5.0
3.3	335	5x11	2.0	6.3x11	2.5	6.3x11	2.5	8x11.5	3.5	10x12.5	5.0	10x16	5.0	10x16	5.0
4.7	475	5x11	2.0	6.3x11	2.5	8x11.5	3.5	8x11.5	3.5	10x16	5.0	10x20	5.0	10x20	5.0
10	106	6.3x11	2.5	10x12.5	5.0	10x12.5	5.0	10x16	5.0	10x20	5.0	12.5x20	5.0	12.5x20	5.0
22	226	6.3x11	2.5	10x20	5.0	10x20	5.0	10x20	5.0	12.5x20	5.0	12.5x25	5.0	16x25	7.5
33	336	8x11.5	3.5	10x20	5.0	12.5x20	5.0	12.5x20	5.0	16x25	7.5	16x25	7.5	16x31.5	7.5
47	476	10x12.5	5.0	12.5x20	5.0	12.5x25	5.0	12.5x25	5.0	16x31.5	7.5	16x31.5	7.5	18x40	7.5
100	107	10x20	5.0	12.5x25	5.0	16x25	7.5	16x35.5	7.5	18x40	7.5	22x40	10	22x45	10
220	227	12.5x20	5.0	16x31.5	7.5	18x35.5	7.5	22x40	10						
330	337	16x25	7.5	18x35.5	7.5										
470	477	16x31.5	7.5												
1000	108	18x40	7.5												
2200	228														
3300	338														
4700	478														
6800	688														
10000	109														
22000	229														

Characteristics - Electrical

																Test Cond. JIS C5101-4, Characteristic W		
Operating Temp. Range	-40°C ~ +85°C															—		
Rated Voltage	DC 6.3 ~ 450V															85°C		
Capacitance	0.1 ~ 22000μF															85°C		
Capacitance Tolerance	±20%															120Hz, 20°C		
Leakage Current	Rated Voltage	≤100V							>100V							C = rated capacitance (μF) V = rated DC working voltage (V) Temperature = 20°C		
	Time	after 2 minutes							after 5 minutes									
	Leakage Current	I = 0.02CV or 3 (μA) whichever is greater							CV ≤1000 I = 0.03CV + 15 (μA)			CV >1000 I = 0.02CV + 25 (μA)						
Dissipation Factor (Tanδ)	Rated Voltage	6.3	10	16	25	35	50	63	100	160	200	250	350	400	450	120Hz, 20°C		
	Tanδ max	0.23	0.20	0.16	0.14	0.12	0.10	0.09	0.08	0.12	0.14	0.17	0.20	0.25	0.25			
Low Temperature Characteristics	Rated Voltage	6.3	10	16	25	35	50	63	100	160	200	250	350	400	450	120Hz		
	Impedance Ratio																	
	Z(-25°C)/∅D<16	6	4	3	3	2	2	2	2	3			6	8	12		14	16
	Z(+20°C)/∅D≥16	8	6	4	4	3	3	3	3	4			8	10	16		18	20
	Z(-40°C)/∅D<16	10	8	6	6	4	3	3	3	4			8	10	16		18	20
Z(+20°C)/∅D≥16	18	16	12	10	8	8	6	6	4			8	10	16	18	20		
Load Life Test	Test Time	2000 Hrs (3000 Hrs for dia ≥10mm)														Specification satisfied when the capacitors are restored to 20°C after the rated voltage applied with rated ripple current for 2000 / 3000 hrs at 85°C		
	Capacitance Change	Within ±20% of initial value																
	Dissipation Factor	Less than 200% of specified value																
	Leakage Current	Within specified value																
Shelf Life Test	Test Time	1000 hrs														Specifications satisfied when the capacitors are restored to 20°C after exposing them for 1000 hrs at 85°C without voltage applied. The rated voltage shall be applied to the capacitors before the measurements for 160 ~ 450V (Refer to JIS C 5102)		
	Capacitance Change	Within ±20% of initial value																
	Dissipation Factor	Less than 200% of specified value																
	Leakage Current	Within specified value																
Ripple Current & Multipliers Frequency	Frequency (Hz)	60(50)			120			500			1k			10k and above			—	
	C (μF) < 100	0.70			1.00			1.30			1.40			1.50				
	C (μF) 100~1000	0.75			1.00			1.20			1.30			1.35				
	C (μF) > 1000	0.80			1.00			1.10			1.12			1.15				

Dimensions

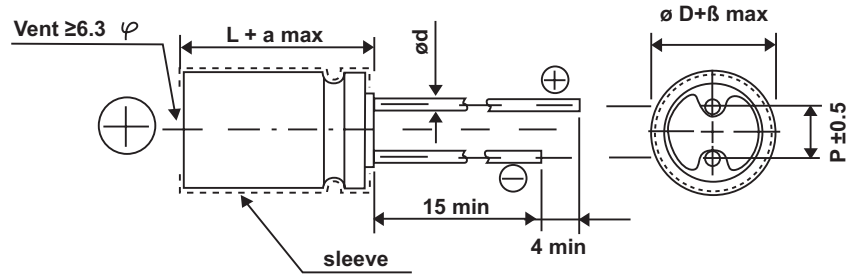

Case Code	Dimensions (mm)			
	Dia + β 0.5 max	L + a max	P±0.5	Lead dia
A11	5.0	11+1.0	2.0	0.5
B11	6.3	11+1.0	2.5	0.5
C11	8.0	11.5 +1.0	3.5	0.6
D12	10	12.5 +1.5	5.0	0.6
D16	10	16 +1.5	5.0	0.6
D20	10	20 +1.5	5.0	0.6
E20	12.5	20 +1.5	5.0	0.6
E25	12.5	25 +1.5	5.0	0.6
F25	16	25 +1.5	7.5	0.8
F31	16	31.5 +1.5	7.5	0.8
F35	16	35.5 +1.5	7.5	0.8
G35	18	35.5 +1.5	7.5	0.8
G40	18	40 +1.5	7.5	0.8
H40	22	40 +2.0	10	1.0
H45	22	45 +2.0	10	1.0
J40	25	40 +2.0	12.5	1.0

How to Order

TYRV	0J	336	A11	M	L
Common Part	Voltage Code	Capacitance	Case Code	Tolerance	Packaging
TYRV	0J (6.3V) 1A (10V) 1C (16V) 1E (25V) 1V (35V) 1H (50V) 1J (63V) 2A (100V) 2C (160V) 2D (200V) 2E (250V) 2V (350V) 2G (400V) 2W (450V)	e.g. 336	e.g. A11	M (20%)	L = Loose (bulk)

Type TYRH Series



Tyco Electronics radial leaded aluminum electrolytic capacitors are designed for through-hole PCB population where board space is restricted.

The TYRH series offers an extended temperature range from -40°C to +105°C.

Suitable for a broad range of general purpose filtering, bypassing, power supply coupling/decoupling, telecommunications and audio-video applications requiring reliability under more demanding conditions.

Key Features

- High temperature polarized aluminum foil electrolytic capacitors
- Radial leads
- Aluminum case with insulating sleeve
- 105°C temperature rating
- 2000 hours load life assured
- RoHS Compliant

Standard Product Table

Rated Voltage V.DC	Capacitance		Case Size Dia x L	Lead Pitch	Case Code	Dissipation Factor (%) [*]	Ripple Current (mA) [*]	Part Number
	µF	Code						
6.3	33	336	5x11	2.0	A11	23	54	TYRH0J336A11ML
6.3	47	476	5x11	2.0	A11	23	65	TYRH0J476A11ML
6.3	100	107	5x11	2.0	A11	23	95	TYRH0J107A11ML
6.3	220	227	5x11	2.0	A11	23	140	TYRH0J227A11ML
6.3	330	337	6.3x11	2.5	B11	23	190	TYRH0J337B11ML
6.3	470	477	6.3x11	2.5	B11	23	230	TYRH0J477B11ML
6.3	1000	108	8x11.5	3.5	C11	23	380	TYRH0J108C11ML
6.3	2200	228	10x20	5.0	D20	23	810	TYRH0J228D20ML
6.3	3300	338	10x20	5.0	D20	23	840	TYRH0J338D20ML
6.3	4700	477	12.5x20	5.0	E20	23	1090	TYRH0J477E20ML
6.3	6800	108	12.5x25	5.0	E25	23	1460	TYRH0J108E25ML
6.3	10000	109	16x25	7.5	F25	23	1990	TYRH0J109F25ML
6.3	22000	229	18x40	7.5	G40	23	3270	TYRH0J229G40ML
10	22	226	5x11	2.0	A11	20	49	TYRH1A226A11ML
10	33	336	5x11	2.0	A11	20	60	TYRH1A336A11ML
10	47	476	5x11	2.0	A11	20	76	TYRH1A476A11ML
10	100	107	5x11	2.0	A11	20	105	TYRH1A107A11ML
10	220	227	6.3x11	2.5	B11	20	175	TYRH1A227B11ML
10	330	337	6.3x11	2.5	B11	20	200	TYRH1A337B11ML
10	470	477	8x11.5	3.5	C11	20	290	TYRH1A477C11ML
10	1000	108	10x12.5	5.0	D12	20	460	TYRH1A108D12ML
10	2200	228	10x20	5.0	D20	20	760	TYRH1A228D20ML
10	3300	338	12.5x20	5.0	E20	20	1100	TYRH1A338E20ML
10	4700	477	12.5x25	5.0	E25	20	1260	TYRH1A477E25ML
10	6800	108	16x25	7.5	F25	20	1690	TYRH1A108F25ML
10	10000	109	16x35.5	7.5	F35	20	2400	TYRH1A109F35ML
16	10	106	5x11	2.0	A11	16	35	TYRH1C106A11ML
16	22	226	5x11	2.0	A11	16	58	TYRH1C226A11ML
16	33	336	5x11	2.0	A11	16	71	TYRH1C336A11ML
16	47	476	5x11	2.0	A11	16	85	TYRH1C476A11ML
16	100	107	5x11	2.0	A11	16	110	TYRH1C107A11ML
16	220	227	6.3x11	2.5	B11	16	190	TYRH1C227B11ML
16	330	337	8x11.5	3.5	C11	16	270	TYRH1C337C11ML
16	470	477	8x11.5	3.5	C11	16	310	TYRH1C477C11ML
16	1000	108	10x16	5.0	D16	16	560	TYRH1C108D16ML
16	2200	228	12.5x20	5.0	E20	16	920	TYRH1C228E20ML
16	3300	338	12.5x25	5.0	E25	16	1170	TYRH1C338E25ML
16	4700	477	16x25	7.5	F25	16	1480	TYRH1C477F25ML
16	6800	108	16x31.5	7.5	F31	16	1930	TYRH1C108F31ML
16	10000	109	18x35.5	7.5	G35	16	2640	TYRH1C109G35ML
25	4.7	475	5x11	2.0	A11	14	26	TYRH1E475A11ML
25	10	106	5x11	2.0	A11	14	43	TYRH1E106A11ML
25	22	226	5x11	2.0	A11	14	62	TYRH1E226A11ML
25	33	336	5x11	2.0	A11	14	76	TYRH1E336A11ML
25	47	476	5x11	2.0	A11	14	97	TYRH1E476A11ML
25	100	107	6.3x11	2.5	B11	14	142	TYRH1E107B11ML
25	220	227	8x11.5	3.5	C11	14	236	TYRH1E227C11ML
25	330	337	8x11.5	3.5	C11	14	310	TYRH1E337C11ML
25	330	337	10x12.5	5.0	D12	14	335	TYRH1E337D12ML
25	470	477	10x12.5	5.0	D12	14	380	TYRH1E477D12ML
25	1000	108	10x20	5.0	D20	14	680	TYRH1E108D20ML

* DF measured at 120Hz, 20°C

* RC measured at 120Hz, 105°C

Standard Product Table (continued)

Rated Voltage V.DC	Capacitance		Case Size Dia x L	Lead Pitch	Case Code	Dissipation Factor (%)*	Ripple Current (mA)*	Part Number
	µF	Code						
25	2200	228	12.5x25	5.0	E25	14	1110	TYRH1E228E25ML
25	3300	338	16x25	7.5	F25	14	1440	TYRH1E338F25ML
25	4700	477	16x31.5	7.5	F31	14	1710	TYRH1E477F31ML
25	6800	108	18x35.5	7.5	G35	14	2160	TYRH1E108G35ML
35	4.7	475	5x11	2.0	A11	12	30	TYRH1V475A11ML
35	10	106	5x11	2.0	A11	12	46	TYRH1V106A11ML
35	22	226	5x11	2.0	A11	12	71	TYRH1V226A11ML
35	33	336	5x11	2.0	A11	12	75	TYRH1V336A11ML
35	47	476	5x11	2.0	A11	12	90	TYRH1V476A11ML
35	100	107	6.3x11	2.5	B11	12	150	TYRH1V107B11ML
35	220	227	8x11.5	3.5	C11	12	270	TYRH1V227C11ML
35	220	227	10x12.5	5.0	D12	12	300	TYRH1V227D12ML
35	330	337	10x12.5	5.0	D12	12	350	TYRH1V337D12ML
35	470	477	10x16	5.0	D16	12	460	TYRH1V477D16ML
35	1000	108	12.5x20	5.0	E20	12	810	TYRH1V108E20ML
35	2200	228	16x25	7.5	F25	12	1260	TYRH1V228F25ML
35	3300	338	16x35.5	7.5	F35	12	1610	TYRH1V338F35ML
35	4700	478	18x35.5	7.5	G35	12	1900	TYRH1V478G35ML
50	0.1	104	5x11	2.0	A11	10	3.2	TYRH1H104A11ML
50	0.22	224	5x11	2.0	A11	10	4.9	TYRH1H224A11ML
50	0.33	334	5x11	2.0	A11	10	6.0	TYRH1H334A11ML
50	0.47	474	5x11	2.0	A11	10	7.1	TYRH1H474A11ML
50	1.0	105	5x11	2.0	A11	10	13	TYRH1H105A11ML
50	2.2	225	5x11	2.0	A11	10	20	TYRH1H225A11ML
50	3.3	335	5x11	2.0	A11	10	30	TYRH1H335A11ML
50	4.7	475	5x11	2.0	A11	10	33	TYRH1H475A11ML
50	10	106	5x11	2.0	A11	10	50	TYRH1H106A11ML
50	22	226	5x11	2.0	A11	10	78	TYRH1H226A11ML
50	33	336	5x11	2.0	A11	10	90	TYRH1H336A11ML
50	47	476	6.3x11	2.5	B11	10	120	TYRH1H476B11ML
50	100	107	8x11.5	3.5	C11	10	188	TYRH1H107C11ML
50	220	227	10x16	5.0	D16	10	300	TYRH1H227D16ML
50	330	337	10x16	5.0	D16	10	410	TYRH1H337D16ML
50	470	477	10x20	5.0	D20	10	530	TYRH1H477D20ML
50	1000	108	12.5x25	5.0	E25	10	950	TYRH1H108E25ML
50	2200	228	16x35.5	7.5	F35	10	1470	TYRH1H228F35ML
50	3300	338	18x35.5	7.5	G35	10	1770	TYRH1H338G35ML
50	4700	478	22x40	10	H40	10	2340	TYRH1H478H40ML
63	10	106	5x11	2.0	A11	9	54	TYRH1J106A11ML
63	22	226	6.3x11	2.5	B11	9	86	TYRH1J226B11ML
63	33	336	6.3x11	2.5	B11	9	100	TYRH1J336B11ML
63	47	476	6.3x11	2.5	B11	9	130	TYRH1J476B11ML
63	100	107	10x12.5	5.0	D12	9	235	TYRH1J107D12ML
63	220	227	10x16	5.0	D16	9	335	TYRH1J227D16ML
63	330	337	10x20	5.0	D20	9	510	TYRH1J337D20ML
63	470	477	12.5x20	5.0	E20	9	640	TYRH1J477E20ML
63	1000	108	16x25	7.5	F25	9	930	TYRH1J108F25ML
63	2200	228	18x40	7.5	G40	9	2340	TYRH1J228G40ML
63	3300	338	22x40	10	H40	9	2510	TYRH1J338H40ML
63	4700	478	25x40	12.5	J40	9	3000	TYRH1J478J40ML

* DF measured at 120Hz, 20°C

* RC measured at 120Hz, 105°C

Standard Product Table (continued)

Rated Voltage V.DC	Capacitance		Case Size Dia x L	Lead Pitch	Case Code	Dissipation Factor (%)*	Ripple Current (mA)*	Part Number
	µF	Code						
100	0.1	104	5x11	2.0	A11	8	4.0	TYRH2A104A11ML
100	0.22	224	5x11	2.0	A11	8	6.0	TYRH2A224A11ML
100	0.33	334	5x11	2.0	A11	8	8.0	TYRH2A334A11ML
100	0.47	474	5x11	2.0	A11	8	9.0	TYRH2A474A11ML
100	1.0	105	5x11	2.0	A11	8	15	TYRH2A105A11ML
100	2.2	225	5x11	2.0	A11	8	30	TYRH2A225A11ML
100	3.3	335	5x11	2.0	A11	8	31	TYRH2A335A11ML
100	4.7	475	5x11	2.0	A11	8	40	TYRH2A475A11ML
100	10	106	6.3x11	2.5	B11	8	54	TYRH2A106B11ML
100	22	226	6.3x11	2.5	B11	8	93	TYRH2A226B11ML
100	33	336	8x11.5	3.5	C11	8	130	TYRH2A336C11ML
100	47	476	10x12.5	5.0	D12	8	165	TYRH2A476D12ML
100	100	107	10x20	5.0	D20	8	265	TYRH2A107D20ML
100	220	227	12.5x20	5.0	E20	8	440	TYRH2A227E20ML
100	330	337	16x25	7.5	F25	8	540	TYRH2A337F25ML
100	470	477	16x31.5	7.5	F31	8	715	TYRH2A477F31ML
100	1000	108	18x40	7.5	G40	8	985	TYRH2A108G40ML
160	0.47	474	6.3x11	2.5	B11	12	13	TYRH2C474B11ML
160	1.0	105	6.3x11	2.5	B11	12	20	TYRH2C105B11ML
160	2.2	225	6.3x11	2.5	B11	12	29	TYRH2C225B11ML
160	3.3	335	6.3x11	2.5	B11	12	36	TYRH2C335B11ML
160	4.7	475	6.3x11	2.5	B11	12	43	TYRH2C475B11ML
160	10	106	10x12.5	5.0	D12	12	87	TYRH2C106D12ML
160	22	226	10x20	5.0	D20	12	158	TYRH2C226D20ML
160	33	336	10x20	5.0	D20	12	190	TYRH2C336D20ML
160	47	476	12.5x20	5.0	E20	12	265	TYRH2C476E20ML
160	100	107	12.5x25	5.0	E25	12	425	TYRH2C107E25ML
160	100	107	16x25	7.5	F25	12	485	TYRH2C107F25ML
160	220	227	16x31.5	7.5	F31	12	660	TYRH2C227F31ML
160	330	337	18x35.5	7.5	G35	12	820	TYRH2C337G35ML
200	0.47	474	6.3x11	2.5	B11	14	14	TYRH2D474B11ML
200	1.0	105	6.3x11	2.5	B11	14	21	TYRH2D105B11ML
200	2.2	225	6.3x11	2.5	B11	14	30	TYRH2D225B11ML
200	3.3	335	6.3x11	2.5	B11	14	39	TYRH2D335B11ML
200	4.7	475	8x11.5	3.5	C11	14	54	TYRH2D475C11ML
200	10	106	10x12.5	5.0	D12	14	94	TYRH2D106D12ML
200	22	226	10x20	5.0	D20	14	170	TYRH2D226D20ML
200	33	336	12.5x20	5.0	E20	14	240	TYRH2D336E20ML
200	47	476	12.5x25	5.0	E25	14	315	TYRH2D476E25ML
200	100	107	16x25	7.5	F25	14	485	TYRH2D107F25ML
200	220	227	18x35.5	7.5	G35	14	835	TYRH2D227G35ML
250	2.2	225	6.3x11	2.5	B11	17	35	TYRH2E225B11ML
250	3.3	335	8x11.5	3.5	C11	17	50	TYRH2E335C11ML
250	4.7	475	8x11.5	3.5	C11	17	60	TYRH2E475C11ML
250	10	106	10x16	5.0	D16	17	115	TYRH2E106D16ML
250	22	226	12.5x20	5.0	E20	17	255	TYRH2E226E20ML
250	33	336	12.5x20	5.0	E20	17	315	TYRH2E336E20ML
250	47	476	12.5x25	5.0	E25	17	350	TYRH2E476E25ML
250	100	107	16x35.5	7.5	F35	17	610	TYRH2E107F35ML
250	220	227	22x40	10	H40	17	945	TYRH2E227H40ML

* DF measured at 120Hz, 20°C

* RC measured at 120Hz, 105°C

Standard Product Table (continued)

Rated Voltage V.DC	Capacitance		Case Size Dia x L	Lead Pitch	Case Code	Dissipation Factor (%) [*]	Ripple Current (mA) [*]	Part Number
	μF	Code						
350	1.0	105	6.3x11	2.5	B11	20	23	TYRH2V105B11ML
350	2.2	225	8x11.5	3.5	C11	20	41	TYRH2V225C11ML
350	3.3	335	10x12.5	5.0	D12	20	59	TYRH2V335D12ML
350	4.7	475	10x16	5.0	D16	20	78	TYRH2V475D16ML
350	10	106	10x20	5.0	D20	20	125	TYRH2V106D20ML
350	22	226	12.5x20	5.0	E20	20	210	TYRH2V226E20ML
350	33	336	16x25	7.5	F25	20	325	TYRH2V336F25ML
350	47	476	16x31.5	7.5	F31	20	395	TYRH2V476F31ML
350	100	107	18x40	7.5	G40	20	575	TYRH2V107G40ML
400	1.0	105	8x11.5	3.5	C11	25	27	TYRH2G105C11ML
400	2.2	225	10x12.5	5.0	D12	25	48	TYRH2G225D12ML
400	3.3	335	10x16	5.0	D16	25	65	TYRH2G335D16ML
400	4.7	475	10x20	5.0	D20	25	86	TYRH2G475D20ML
400	10	106	12.5x20	5.0	E20	25	145	TYRH2G106E20ML
400	22	226	12.5x25	5.0	E25	25	235	TYRH2G226E25ML
400	22	226	16x25	7.5	F25	25	265	TYRH2G226F25ML
400	33	336	16x31.5	7.5	F31	25	360	TYRH2G336F31ML
400	47	476	16x35.5	7.5	F35	25	420	TYRH2G476F35ML
400	100	107	22x40	10	H40	25	595	TYRH2G107H40ML
450	1.0	105	8x11.5	3.5	C11	25	27	TYRH2W105C11ML
450	2.2	225	10x12.5	5.0	D12	25	48	TYRH2W225D12ML
450	3.3	335	10x16	5.0	D16	25	65	TYRH2W335D16ML
450	4.7	475	10x20	5.0	D20	25	86	TYRH2W475D20ML
450	10	106	12.5x20	5.0	E20	25	145	TYRH2W106E20ML
450	22	226	16x25	7.5	F25	25	265	TYRH2W226F25ML
450	33	336	16x31.5	7.5	F31	25	360	TYRH2W336F31ML
450	47	476	18x40	7.5	G40	25	515	TYRH2W476G40ML
450	100	107	22x45	10	H45	25	625	TYRH2W107H45ML

* DF measured at 120Hz, 20°C

* RC measured at 120Hz, 105°C

Product Availability Chart

Capacitance		Rated Voltage (V.DC)													
		6.3		10		16		25		35		50		63	
µF	Code	Dia x L	P	Dia x L	P	Dia x L	P	Dia x L	P	Dia x L	P	Dia x L	P	Dia x L	P
0.1	104											5x11	2.0		
0.22	224											5x11	2.0		
0.33	334											5x11	2.0		
0.47	474											5x11	2.0		
1.0	105											5x11	2.0		
2.2	225											5x11	2.0		
3.3	335											5x11	2.0		
4.7	475							5x11	2.0	5x11	2.0	5x11	2.0		
10	106					5x11	2.0	5x11	2.0	5x11	2.0	5x11	2.0	5x11	2.0
22	226			5x11	2.0	5x11	2.0	5x11	2.0	5x11	2.0	5x11	2.0	6.3x11	2.5
33	336	5x11	2.0	5x11	2.0	5x11	2.0	5x11	2.0	5x11	2.0	5x11	2.0	6.3x11	2.5
47	476	5x11	2.0	5x11	2.0	5x11	2.0	5x11	2.0	5x11	2.0	6.3x11	2.5	6.3x11	2.5
100	107	5x11	2.0	5x11	2.0	5x11	2.0	6.3x11	2.5	6.3x11	2.5	8x11.5	3.5	10x12.5	5.0
220	227	5x11	2.0	6.3x11	2.5	6.3x11	2.5	8x11.5	3.5	8x11.5	3.5	10x16	5.0	10x16	5.0
330	337	6.3x11	2.5	6.3x11	2.5	8x11.5	3.5	8x11.5	3.5	10x12.5	5.0	10x16	5.0	10x20	5.0
470	477	6.3x11	2.5	8x11.5	3.5	8x11.5	3.5	10x12.5	5.0	10x16	5.0	10x20	5.0	12.5x20	5.0
1000	108	8x11.5	3.5	10x12.5	5.0	10x16	5.0	10x20	5.0	12.5x20	5.0	12.5x25	5.0	16x25	7.5
2200	228	10x20	5.0	10x20	5.0	12.5x20	5.0	12.5x25	5.0	16x25	7.5	16x35.5	7.5	18x40	7.5
3300	338	10x20	5.0	12.5x20	5.0	12.5x25	5.0	16x25	7.5	16x35.5	7.5	18x35.5	7.5	22x40	10
4700	478	12.5x20	5.0	12.5x25	5.0	16x25	7.5	16x31.5	7.5	18x35.5	7.5	22x40	10	25x40	12.5
6800	688	12.5x25	5.0	16x25	7.5	16x31.5	7.5	18x35.5	7.5						
10000	109	16x25	7.5	16x35.5	7.5	18x35.5	7.5								
22000	229	18x40	7.5												

Capacitance		Rated Voltage (V.DC)													
		100		160		200		250		350		400		450	
µF	Code	Dia x L	P	Dia x L	P	Dia x L	P	Dia x L	P	Dia x L	P	Dia x L	P	Dia x L	P
0.1	104	5x11	2.0												
0.22	224	5x11	2.0												
0.33	334	5x11	2.0												
0.47	474	5x11	2.0	6.3x11	2.5	6.3x11	2.5								
1.0	105	5x11	2.0	6.3x11	2.5	6.3x11	2.5			6.3x11	2.5	8x11.5	3.5	8x11.5	3.5
2.2	225	5x11	2.0	6.3x11	2.5	6.3x11	2.5	6.3x11	2.5	8x11.5	3.5	10x12.5	5.0	10x12.5	5.0
3.3	335	5x11	2.0	6.3x11	2.5	6.3x11	2.5	8x11.5	3.5	10x12.5	5.0	10x16	5.0	10x16	5.0
4.7	475	6.3x11	2.5	6.3x11	2.5	8x11.5	3.5	8x11.5	3.5	10x16	5.0	10x20	5.0	10x20	5.0
10	106	6.3x11	2.5	10x12.5	5.0	10x12.5	5.0	10x16	5.0	10x20	5.0	12.5x20	5.0	12.5x20	5.0
22	226	6.3x11	2.5	10x20	5.0	10x20	5.0	12.5x20	5.0	12.5x20	5.0	12.5x25	5.0	16x25	7.5
33	336	8x11.5	3.5	10x20	5.0	12.5x20	5.0	12.5x20	5.0	16x25	7.5	16x31.5	7.5	16x31.5	7.5
47	476	10x12.5	5.0	12.5x20	5.0	12.5x25	5.0	12.5x25	5.0	16x31.5	7.5	16x35.5	7.5	18x40	7.5
100	107	10x20	5.0	12.5x25	5.0	16x25	7.5	16x35.5	7.5	18x40	7.5	22x40	10	22x45	10
220	227	12.5x25	5.0	16x31.5	7.5	18x35.5	7.5	22x40	10						
330	337	16x25	7.5	18x35.5	7.5										
470	477	16x31.5	7.5												
1000	108	18x40	7.5												
2200	228														
3300	338														
4700	478														
6800	688														
10000	109														
22000	229														

Characteristics - Electrical

																Test Cond. JIS C5101-4, Characteristic W	
Operating Temp. Range	-40°C ~ +105°C															—	
Rated Voltage	DC 6.3 ~ 450V															105°C	
Capacitance	0.1 ~ 22000μF															105°C	
Capacitance Tolerance	±20%															120Hz, 20°C	
Leakage Current	Rated Voltage	≤100V							>100V							C = rated capacitance (μF) V = rated DC working voltage (V) Temperature = 20°C	
	Time	after 2 minutes							after 5 minutes								
	Leakage Current	I = 0.01CV or 3 (μA) whichever is greater							CV ≤1000 I = 0.03CV + 15 (μA)			CV >1000 I = 0.02CV + 25 (μA)					
Dissipation Factor (Tanδ)	Rated Voltage	6.3	10	16	25	35	50	63	100	160	200	250	350	400	450	120Hz, 20°C	
	Tanδ max	0.23	0.20	0.16	0.14	0.12	0.10	0.09	0.08	0.12	0.14	0.17	0.20	0.25	0.25		
	When capacitance exceeds 1000μF, add 0.02 for every 1000μF increase																
Low Temperature Characteristics	Rated Voltage	6.3	10	16	25	35	50	63	100	160	200	250	350	400	450	120Hz	
	Impedance Ratio																
	Z(-25°C)/∅D<16	4	3	3	2	2	2	2	2	3	6	8	12	14	16		
	Z(+20°C)/∅D≥16	6	4	4	3	3	3	3	3	4	8	10	16	18	20		
	Z(-40°C)/∅D<16	8	6	6	4	4	3	3	3	4	8	10	16	18	20		
Z(+20°C)/∅D≥16	12	10	8	8	8	8	6	6	4	8	10	16	18	20			
Load Life Test	Test Time	2000 Hrs														Specification satisfied when the capacitors are restored to 20°C after the rated voltage applied with rated ripple current for 2000 hrs at 105°C	
	Capacitance Change	Within ±20% of initial value															
	Dissipation Factor	Less than 200% of specified value															
	Leakage Current	Within specified value															
Shelf Life Test	Test Time	1000 hrs														Specifications satisfied when the capacitors are restored to 20°C after exposing them for 1000 hrs at 105°C without voltage applied. The rated voltage shall be applied to the capacitors before the measurements for 160 ~ 450V (Refer to JIS C 5102)	
	Capacitance Change	Within ±20% of initial value															
	Dissipation Factor	Less than 200% of specified value															
	Leakage Current	Within specified value															
Ripple Current & Multipliers Frequency	Frequency (Hz)	60(50)			120			500			1k			10k and above			—
	C (μF) < 100	0.70			1.00			1.30			1.40			1.50			
	C (μF) 100~1000	0.75			1.00			1.20			1.30			1.35			
	C (μF) > 1000	0.80			1.00			1.10			1.12			1.15			

Dimensions

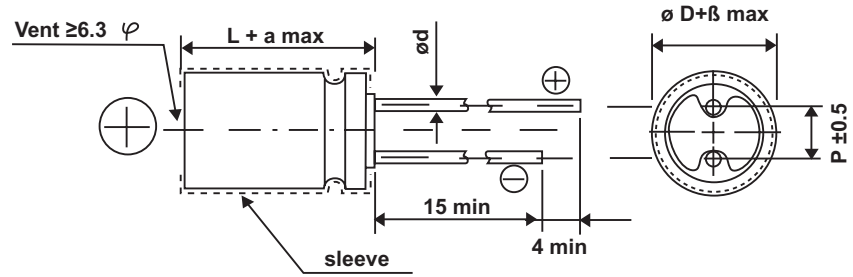

Case Code	Dimensions (mm)			
	Dia + β 0.5 max	L + a max	P \pm 0.5	Lead dia
A11	5.0	11+1.0	2.0	0.5
B11	6.3	11+1.0	2.5	0.5
C11	8.0	11.5 +1.0	3.5	0.6
D12	10	12.5 +1.5	5.0	0.6
D16	10	16 +1.5	5.0	0.6
D20	10	20 +1.5	5.0	0.6
E20	12.5	20 +1.5	5.0	0.6
E25	12.5	25 +1.5	5.0	0.6
F25	16	25 +1.5	7.5	0.8
F31	16	31.5 +1.5	7.5	0.8
F35	16	35.5 +1.5	7.5	0.8
G35	18	35.5 +1.5	7.5	0.8
G40	18	40 +1.5	7.5	0.8
H40	22	40 +2.0	10	1.0
H45	22	45 +2.0	10	1.0
J40	25	40 +2.0	12.5	1.0

How to Order

TYRH	0J	336	A11	M	L
Common Part	Voltage Code	Capacitance	Case Code	Tolerance	Packaging
TYRH	0J (6.3V) 1A (10V) 1C (16V) 1E (25V) 1V (35V) 1H (50V) 1J (63V) 2A (100V) 2C (160V) 2D (200V) 2E (250V) 2V (350V) 2G (400V) 2W (450V)	e.g. 336	e.g. A11	M (20%)	L = Loose (bulk)

Type TYRE Series



Tyco Electronics radial leaded aluminum electrolytic capacitors are designed for through-hole PCB population where board space is restricted.

The TYRE series offers low impedance and higher ripple current for unit size. Extended temperature range (-55°C to +105°C) for use in applications where high reliability is required under extreme conditions.

Key Features

- Low impedance polarized aluminum foil electrolytic capacitors
- High ripple current rating per unit size
- Radial leads
- Aluminum case with insulating sleeve
- Wide temperature range: -55°C to +105°C
- 4000 to 7000 hours load life assured
- RoHS Compliant

Characteristics - Electrical

		Test Conditions JIS C5101-4									
Operating Temp. Range	-55°C ~ +105°C	—									
Rated Voltage	DC 6.3 ~ 100V	105°C									
Capacitance	0.47 ~ 15000µF	105°C									
Capacitance Tolerance	±20%	120Hz, 20°C									
Leakage Current	I = 0.01 CV or 3µA whichever is greater after 2 minutes	C = rated capacitance (µF) V = rated DC working voltage (V) Temperature = 20°C									
Dissipation Factor (Tanδ)	Rated Voltage	6.3	10	16	25	35	50	63	100	120Hz, 20°C	
	Tanδ max	0.22	0.19	0.16	0.14	0.12	0.10	0.09	0.08		
Low Temperature Characteristics	Rated Voltage	6.3	10	16	25	35	50	63	100	120Hz	
	Impedance Ratio (max)										
	Z(-55°C)/Z(+20°C)	3	3	3	3	3	3	3	3		
Load Life Test	Test Time	4000 Hrs for øD ≤ 6.3mm 5000 Hrs for øD = 8mm 6000 Hrs for øD = 10mm 7000 Hrs for øD ≥ 12.5mm								Specifications satisfied when the capacitors are restored to 20°C after the rated voltage applied with rated ripple current for 4000~7000 hrs at 105°C	
	Capacitance Change	Within ±25% of initial value									
	Dissipation Factor	Less than 200% of specified value									
	Leakage Current	Within specified value									
Shelf Life Test	Test Time	1000 hrs								Specifications satisfied when the capacitors are restored to 20°C after exposing them for 1000 hrs at 105°C without voltage applied.	
	Capacitance Change	Within ±25% of initial value									
	Dissipation Factor	Less than 200% of specified value									
	Leakage Current	Within specified value									
Ripple Current & Multipliers Frequency	Frequency (Hz)	120	1k	10k	100k and above						—
	C (µF) < 33	0.42	0.70	0.90	1.0						
	C (µF) 39 ~ 270	0.5	0.73	0.92	1.0						
	C (µF) 330 ~ 680	0.55	0.77	0.94	1.0						
	C (µF) 820 ~ 1800	0.6	0.8	0.96	1.0						
	C (µF) 2200 ~ 15000	0.7	0.85	0.98	1.0						

Product Availability Chart

Capacitance		Rated Voltage (V.DC)															
		6.3		10		16		25		35		50		63		100	
µF	Code	Dia x L Pitch	Dia x L Pitch	Dia x L Pitch	Dia x L Pitch	Dia x L Pitch	Dia x L Pitch	Dia x L Pitch	Dia x L Pitch	Dia x L Pitch	Dia x L Pitch	Dia x L Pitch	Dia x L Pitch	Dia x L Pitch	Dia x L Pitch	Dia x L Pitch	
0.47	474															5x11 2.0	
1.0	105															5x11 2.0	
2.2	225															5x11 2.0	
3.3	335															5x11 2.0	
4.7	475							5x11 2.0		5x11 2.0		5x11 2.0		5x11 2.0		5x11 2.0	
6.8	685													5x11 2.0		5x11 2.0	
10	106					5x11 2.0		5x11 2.0		5x11 2.0		5x11 2.0		5x11 2.0		6.3x11 2.5	
12	126													5x11 2.0			
15	156													6.3x11 2.5		8x11.5 3.5	
18	186											5x11 2.0				6.3x15 2.5	
22	226	5x11 2.0		5x11 2.0		5x11 2.0		5x11 2.0		5x11 2.0		5x11 2.0		6.3x11 2.5		8x11.5 3.5	
27	276									5x11 2.0							
33	336	5x11 2.0		5x11 2.0		5x11 2.0		5x11 2.0		5x11 2.0		6.3x11 2.5		6.3x11 2.5		8x15 3.5	
																10x12.5 5.0	

Product Availability Chart (continued)

Capacitance		Rated Voltage (V.DC)															
		6.3		10		16		25		35		50		63		100	
µF	Code	Dia x L	Pitch	Dia x L	Pitch	Dia x L	Pitch	Dia x L	Pitch	Dia x L	Pitch	Dia x L	Pitch	Dia x L	Pitch	Dia x L	Pitch
39	396							5x11	2.0					6.3x15	2.5		
47	476	5x11	2.0	5x11	2.0	5x11	2.0	5x11	2.0	6.3x11	2.5	6.3x11	2.5	8x11.5	3.5	8x20	3.5
																10x16	5.0
56	566					5x11	2.0			6.3x11	2.5	6.3x15	2.5				
68	686													8x11.5	3.5	10x20	5.0
82	826			5x11	2.0			6.3x11	2.5	6.3x15	2.5	8x11.5	3.5			10x25	5.0
100	107	5x11	2.0	5x11	2.0	6.3x11	2.5	6.3x11	2.5	8x11.5	3.5	8x11.5	3.5	8x15	3.5	12.5x20	5.0
														10x12.5	5.0		
120	127					6.3x11	2.5	6.3x15	2.5			8x15	3.5	10x16	5.0		
												10x12.5	5.0				
150	157	6.3x11	2.5	6.3x11	2.5	6.3x11	2.5	8x11.5	3.5	8x11.5	3.5	10x12.5	5.0	10x16	5.0	12.5x25	5.0
				6.3x11	2.5	6.3x15	2.5					8x20	3.5	10x20	5.0	12.5x30	5.0
180	187											10x16	5.0	12.5x16	5.0	16x20	7.5
												10x20	5.0	10x25	5.0	18x20	7.5
220	227	6.3x11	2.5	6.3x11	2.5	8x11.5	3.5	8x11.5	3.5	8x15	3.5	10x16	5.0	10x20	5.0	16x25	7.5
				6.3x15	2.5					10x12.5	5.0	10x20	5.0	10x25	5.0	18x20	7.5
270	277											10x25	5.0	16x16	7.5		
330	337	6.3x11	2.5	8x11.5	3.5	8x11.5	3.5	8x15	3.5	8x20	3.5	10x20	5.0	12.5x20	5.0	16x25	7.5
		6.3x15	2.5					10x12.5	5.0	10x16	5.0	10x30	5.0				
390	397									10x20	5.0	12.5x20	5.0	12.5x25	5.0	18x25	7.5
														18x16	7.5		
470	477	8x11.5	3.5	8x11.5	3.5	8x15	3.5	8x20	3.5	10x20	5.0	12.5x20	5.0	12.5x25	5.0	16x31.5	7.5
						10x12.5	5.0	10x16	5.0					12.5x30	5.0		
														16x20	7.5		
560	567	8x11.5	3.5					10x20	5.0	10x25	5.0	12.5x25	5.0	16x25	7.5	18x31.5	7.5
																18x35.5	7.5
680	687	10x12.5	5.0	8x15	3.5	8x20	3.5	10x20	5.0	10x30	5.0	12.5x25	5.0	12.5x35	5.0		
				10x12.5	5.0	10x16	5.0			12.5x20	5.0	16x20	7.5	18x20	7.5		
820	827	8x15	3.5			10x20	5.0	10x25	5.0			12.5x35	5.0	16x31.5	7.5	18x40	7.5
		10x12.5	5.0									18x20	7.5	18x25	7.5		
1000	108	10x12.5	5.0	8x20	3.5	10x20	5.0	10x30	5.0	12.5x25	5.0	16x25	7.5	16x31.5	7.5		
				10x16	5.0			12.5x20	5.0					16x35.5	7.5		
1200	128	8x20	3.5	10x20	5.0	10x25	5.0			12.5x30	5.0	16x31.5	7.5	18x31.5	7.5		
		10x16	5.0							16x20	7.5	18x25	7.5				
1500	158	10x20	5.0	10x20	5.0	10x30	5.0	12.5x25	5.0	12.5x35	5.0	16x31.5	7.5	18x35.5	7.5		
				10x25	5.0	12.5x20	5.0	16x25	7.5	16x25	7.5	16x35.5	7.5				
1800	188							12.5x30	5.0	16x25	7.5	18x31.5	7.5				
								16x20	7.5	18x20	7.5						
2200	228	10x25	5.0	10x30	5.0	12.5x25	5.0	12.5x35	5.0	16x31.5	7.5	18x35.5	7.5	18x40	7.5		
		12.5x20	5.0	12.5x20	5.0			16x25	7.5	18x25	7.5						
								18x20	7.5								
2700	278	10x30	5.0	12.5x25	5.0	12.5x30	5.0	16x25	7.5	16x35.5	7.5						
						16x20	7.5			18x31.5	7.5						
3300	338	12.5x20	5.0	12.5x25	5.0	12.5x35	5.0	16x31.5	7.5	18x35.5	7.5						
				12.5x30	5.0	16x25	7.5	18x25	7.5								
3900	398	12.5x25	5.0	12.5x35	5.0	16x25	7.5	16x35.5	7.5								
				16x20	7.5	18x20	7.5	18x31.5	7.5								
4700	478	12.5x30	5.0	16x25	7.5	16x31.5	7.5	18x35.5	7.5	18x40	7.5						
		16x25	7.5			18x25	7.5										
5600	568	12.5x35	5.0	16x25	7.5	16x35.5	7.5										
		16x20	7.5	18x20	7.5	18x31.5	7.5										
6800	688	16x25	7.5	16x31.5	7.5	18x35.5	7.5	18x40	7.5								
		18x20	7.5	18x25	7.5												
8200	828	16x31.5	7.5	16x35.5	7.5	18x35.5	7.5										
				18x31.5	7.5												
10000	109	16x31.5	7.5	18x35.5	7.5	18x40	7.5										
		18x25	7.5														
12000	129	18x31.5	7.5														
15000	159	18x35.5	7.5	18x40	7.5												

Standard Product Table

Rated Voltage V.DC	Capacitance		Case Size Dia x L	Lead Pitch	Case Code	Dissipation Factor (%)*	Ripple Current (mA)*	Impedance Max (Ω)*	Ripple Part Number
	μF	Code							
6.3	22	226	5 x 11	2.0	A11	22	180	0.6	TYRE0J226A11ML
6.3	33	336	5 x 11	2.0	A11	22	180	0.6	TYRE0J336A11ML
6.3	47	476	5 x 11	2.0	A11	22	180	0.6	TYRE0J476A11ML
6.3	100	107	5 x 11	2.0	A11	22	180	0.6	TYRE0J107A11ML
6.3	150	157	6.3 x 11	2.5	B11	22	290	0.25	TYRE0J157B11ML
6.3	220	227	6.3 x 11	2.5	B11	22	290	0.25	TYRE0J227B11ML
6.3	330	337	6.3 x 11	2.5	B11	22	290	0.25	TYRE0J337B11ML
6.3	330	337	6.3 x 15	2.5	B15	22	430	0.23	TYRE0J337B15ML
6.3	470	477	8 x 11.5	3.5	C11	22	555	0.117	TYRE0J477C11ML
6.3	560	567	8 x 11.5	3.5	C11	22	555	0.117	TYRE0J567C11ML
6.3	680	687	10 x 12.5	5.0	D12	22	755	0.09	TYRE0J687D12ML
6.3	820	827	8 x 15	3.5	C15	22	730	0.085	TYRE0J827C15ML
6.3	820	827	10 x 12.5	5.0	D12	22	755	0.09	TYRE0J827D12ML
6.3	1000	108	10 x 12.5	5.0	D12	22	755	0.09	TYRE0J108D12ML
6.3	1200	128	8 x 20	3.5	C20	22	955	0.065	TYRE0J128C20ML
6.3	1200	128	10 x 16	5.0	D16	22	1050	0.068	TYRE0J128D16ML
6.3	1500	158	10 x 20	5.0	D20	22	1220	0.052	TYRE0J158D20ML
6.3	2200	228	10 x 25	5.0	D25	22	1440	0.045	TYRE0J228D25ML
6.3	2200	228	12.5 x 20	5.0	E20	22	1815	0.038	TYRE0J228E20ML
6.3	2700	278	10 x 30	5.0	D30	22	1815	0.035	TYRE0J278D30ML
6.3	3300	338	12.5 x 20	5.0	E20	22	1655	0.038	TYRE0J338E20ML
6.3	3900	398	12.5 x 25	5.0	E25	22	1945	0.03	TYRE0J398E25ML
6.3	4700	478	12.5 x 30	5.0	E30	22	2310	0.025	TYRE0J478E30ML
6.3	4700	478	16 x 25	7.5	F25	22	2555	0.022	TYRE0J478F25ML
6.3	5600	568	12.5 x 35	5.0	E35	22	2510	0.022	TYRE0J568E35ML
6.3	5600	568	16 x 20	7.5	F20	22	2205	0.029	TYRE0J568F20ML
6.3	6800	688	16 x 25	7.5	F25	22	2555	0.022	TYRE0J688F25ML
6.3	6800	688	18 x 20	7.5	G20	22	2490	0.028	TYRE0J688G20ML
6.3	8200	828	16 x 31.5	7.5	F31	22	3010	0.018	TYRE0J828F31ML
6.3	10000	109	16 x 31.5	7.5	F31	22	3150	0.016	TYRE0J109F31ML
6.3	10000	109	18 x 25	7.5	G25	22	2740	0.02	TYRE0J109G25ML
6.3	12000	129	18 x 31.5	7.5	G31	22	3635	0.016	TYRE0J129G31ML
6.3	15000	159	18 x 35.5	7.5	G35	22	3680	0.015	TYRE0J159G35ML
10	22	226	5 x 11	2.0	A11	19	180	0.6	TYRE1A226A11ML
10	33	336	5 x 11	2.0	A11	19	180	0.6	TYRE1A336A11ML
10	47	476	5 x 11	2.0	A11	19	180	0.6	TYRE1A476A11ML
10	82	826	5 x 11	2.0	A11	19	180	0.6	TYRE1A826A11ML
10	100	107	5 x 11	2.0	A11	19	180	0.6	TYRE1A107A11ML
10	150	157	6.3 x 11	2.5	B11	19	290	0.25	TYRE1A157B11ML
10	180	187	6.3 x 11	2.5	B11	19	290	0.25	TYRE1A187B11ML
10	220	227	6.3 x 11	2.5	B11	19	290	0.25	TYRE1A227B11ML
10	220	227	6.3 x 15	2.5	B15	19	430	0.23	TYRE1A227B15ML
10	330	337	8 x 11.5	3.5	C11	19	555	0.117	TYRE1A337C11ML
10	470	477	8 x 11.5	3.5	C11	19	555	0.117	TYRE1A477C11ML
10	680	687	8 x 15	3.5	C15	19	730	0.085	TYRE1A687C15ML
10	680	687	10 x 12.5	5.0	D12	19	755	0.09	TYRE1A687D12ML
10	1000	108	8 x 20	3.5	C20	19	995	0.065	TYRE1A108C20ML
10	1000	108	10 x 16	5.0	D16	19	1050	0.068	TYRE1A108D16ML
10	1200	128	10 x 20	5.0	D20	19	1220	0.052	TYRE1A128D20ML
10	1500	158	10 x 20	5.0	D20	19	1220	0.052	TYRE1A158D20ML
10	1500	158	10 x 25	5.0	D25	19	1440	0.045	TYRE1A158D25ML
10	2200	228	10 x 30	5.0	D30	19	1815	0.035	TYRE1A228D30ML

* DF measured at 120Hz, 20°C

* RC measured at 100kHz, 105°C

* ESR measured at 100kHz, 20°C

Standard Product Table (continued)

Rated Voltage V.DC	Capacitance		Case Size Dia x L	Lead Pitch	Case Code	Dissipation Factor (%)*	Ripple Current (mA)*	Impedance Max (Ω)*	Ripple Part Number
	μF	Code							
10	2200	228	12.5 x 20	5.0	E20	19	1655	0.038	TYRE1A228E20ML
10	2700	278	12.5 x 25	5.0	E25	19	1945	0.03	TYRE1A278E25ML
10	3300	338	12.5 x 25	5.0	E25	19	1945	0.03	TYRE1A338E25ML
10	3300	338	12.5 x 30	5.0	E30	19	2310	0.025	TYRE1A338E30ML
10	3900	398	12.5 x 35	5.0	E35	19	2510	0.022	TYRE1A398E35ML
10	3900	398	16 x 20	7.5	F20	19	2205	0.029	TYRE1A398F20ML
10	4700	478	16 x 25	7.5	F25	19	2555	0.022	TYRE1A478F25ML
10	5600	568	16 x 25	7.5	F25	19	2555	0.022	TYRE1A568F25ML
10	5600	568	18 x 20	7.5	G20	19	2490	0.028	TYRE1A568G20ML
10	6800	688	16 x 31.5	7.5	F31	19	3010	0.018	TYRE1A688F31ML
10	6800	688	18 x 25	7.5	G25	19	2740	0.02	TYRE1A688G25ML
10	8200	828	16 x 35.5	7.5	F35	19	3150	0.016	TYRE1A828F35ML
10	8200	828	18 x 31.5	7.5	G31	19	3635	0.016	TYRE1A828G31ML
10	10000	109	18 x 35.5	7.5	G35	19	3680	0.015	TYRE1A109G35ML
10	15000	159	18 x 40	7.5	G40	19	3800	0.014	TYRE1A159G40ML
16	10	106	5 x 11	2.0	A11	16	180	0.6	TYRE1C106A11ML
16	22	226	5 x 11	2.0	A11	16	180	0.6	TYRE1C226A11ML
16	33	336	5 x 11	2.0	A11	16	180	0.6	TYRE1C336A11ML
16	47	476	5 x 11	2.0	A11	16	180	0.6	TYRE1C476A11ML
16	56	566	5 x 11	2.0	A11	16	180	0.6	TYRE1C566A11ML
16	100	107	6.3 x 11	2.5	B11	16	290	0.25	TYRE1C107B11ML
16	120	127	6.3 x 11	2.5	B11	16	290	0.25	TYRE1C127B11ML
16	150	157	6.3 x 11	2.5	B11	16	290	0.25	TYRE1C157B11ML
16	180	187	6.3 x 15	2.5	B15	16	430	0.23	TYRE1C187B15ML
16	220	227	8 x 11.5	3.5	C11	16	555	0.117	TYRE1C227C11ML
16	330	337	8 x 11.5	3.5	C11	16	555	0.117	TYRE1C337C11ML
16	470	477	8 x 15	3.5	C15	16	730	0.085	TYRE1C477C15ML
16	470	477	10 x 12.5	5.0	D12	16	755	0.09	TYRE1C477D12ML
16	680	687	8 x 20	3.5	C20	16	995	0.065	TYRE1C687C20ML
16	680	687	10 x 16	5.0	D16	16	1050	0.068	TYRE1C687D16ML
16	820	827	10 x 20	5.0	D20	16	1220	0.052	TYRE1C827D20ML
16	1000	108	10 x 20	5.0	D20	16	1220	0.052	TYRE1C108D20ML
16	1200	128	10 x 25	5.0	D25	16	1440	0.045	TYRE1C128D25ML
16	1500	158	10 x 30	5.0	D30	16	1815	0.035	TYRE1C158D30ML
16	1500	158	12.5 x 20	5.0	E20	16	1655	0.038	TYRE1C158E20ML
16	2200	228	12.5 x 25	5.0	E25	16	1945	0.03	TYRE1C228E25ML
16	2700	278	12.5 x 30	5.0	E30	16	2310	0.025	TYRE1C278E30ML
16	2700	278	16 x 20	7.5	F20	16	2205	0.029	TYRE1C278F20ML
16	3300	338	12.5 x 35	5.0	E35	16	2510	0.022	TYRE1C338E35ML
16	3300	338	16 x 25	7.5	F25	16	2555	0.022	TYRE1C338F25ML
16	3900	398	16 x 25	7.5	F25	16	2555	0.022	TYRE1C398F25ML
16	3900	398	18 x 20	7.5	G20	16	2490	0.028	TYRE1C398G20ML
16	4700	478	16 x 31.5	7.5	F31	16	3010	0.018	TYRE1C478F31ML
16	4700	478	18 x 25	7.5	G25	16	2740	0.02	TYRE1C478G25ML
16	5600	568	16 x 35.5	7.5	F35	16	3150	0.016	TYRE1C568F35ML
16	5600	568	18 x 31.5	7.5	G31	16	3635	0.016	TYRE1C568G31ML
16	6800	688	18 x 35.5	7.5	G35	16	3680	0.015	TYRE1C688G35ML
16	8200	828	18 x 35.5	7.5	G35	16	3680	0.015	TYRE1C828G35ML
16	10000	109	18 x 40	7.5	G40	16	3800	0.014	TYRE1C109G40ML
25	4.7	475	5 x 11	2.0	A11	14	180	0.6	TYRE1E475A11ML
25	10	106	5 x 11	2.0	A11	14	180	0.6	TYRE1E106A11ML
25	22	226	5 x 11	2.0	A11	14	180	0.6	TYRE1E226A11ML
25	33	336	5 x 11	2.0	A11	14	180	0.6	TYRE1E336A11ML

* DF measured at 120Hz, 20°C

* RC measured at 100kHz, 105°C

* ESR measured at 100kHz, 20°C

Standard Product Table (continued)

Rated Voltage V.DC	Capacitance		Case Size Dia x L	Lead Pitch	Case Code	Dissipation Factor (%)*	Ripple Current (mA)*	Impedance Max (Ω)*	Ripple Part Number
	μF	Code							
25	39	396	5 x 11	2.0	A11	14	180	0.6	TYRE1E396A11ML
25	47	476	5 x 11	2.0	A11	14	180	0.6	TYRE1E476A11ML
25	82	826	6.3 x 11	2.5	B11	14	290	0.25	TYRE1E826B11ML
25	100	107	6.3 x 11	2.5	B11	14	290	0.25	TYRE1E107B11ML
25	120	127	6.3 x 15	2.5	B15	14	430	0.23	TYRE1E127B15ML
25	150	157	8 x 11.5	3.5	C11	14	555	0.117	TYRE1E157C11ML
25	220	227	8 x 11.5	3.5	C11	14	555	0.117	TYRE1E227C11ML
25	330	337	8 x 15	3.5	C15	14	730	0.085	TYRE1E337C15ML
25	330	337	10 x 12.5	5.0	D12	14	755	0.09	TYRE1E337D12ML
25	470	477	8 x 20	3.5	C20	14	995	0.065	TYRE1E477C20ML
25	470	477	10 x 16	5.0	D16	14	1050	0.068	TYRE1E477D16ML
25	560	567	10 x 20	5.0	D20	14	1220	0.052	TYRE1E567D20ML
25	680	687	10 x 20	5.0	D20	14	1220	0.052	TYRE1E687D20ML
25	820	827	10 x 25	5.0	D25	14	1440	0.045	TYRE1E827D25ML
25	1000	108	10 x 30	5.0	D30	14	1815	0.035	TYRE1E108D30ML
25	1000	108	12.5 x 20	5.0	E20	14	1655	0.038	TYRE1E108E20ML
25	1500	158	12.5 x 25	5.0	E25	14	1945	0.03	TYRE1E158E25ML
25	1500	158	16 x 25	7.5	F25	14	2555	0.022	TYRE1E158F25ML
25	1800	188	12.5 x 30	5.0	E30	14	2310	0.025	TYRE1E188E30ML
25	1800	188	16 x 20	7.5	F20	14	2205	0.029	TYRE1E188F20ML
25	2200	228	12.5 x 35	5.0	E35	14	2510	0.022	TYRE1E228E35ML
25	2200	228	16 x 25	7.5	F25	14	2555	0.028	TYRE1E228F25ML
25	2200	228	18 x 20	7.5	G20	14	2490	0.022	TYRE1E228G20ML
25	2700	278	16 x 25	7.5	F25	14	2555	0.022	TYRE1E278F25ML
25	3300	338	16 x 31.5	7.5	F31	14	3010	0.018	TYRE1E338F31ML
25	3300	338	18 x 25	7.5	G25	14	2740	0.02	TYRE1E338G25ML
25	3900	398	16 x 35.5	7.5	F35	14	3150	0.016	TYRE1E398F35ML
25	3900	398	18 x 31.5	7.5	G31	14	3635	0.016	TYRE1E398G31ML
25	4700	478	18 x 35.5	7.5	G35	14	3680	0.015	TYRE1E478G35ML
25	6800	688	18 x 40	7.5	G40	14	3800	0.014	TYRE1E688G40ML
35	4.7	475	5 x 11	2.0	A11	12	180	0.6	TYRE1V475A11ML
35	10	106	5 x 11	2.0	A11	12	180	0.6	TYRE1V106A11ML
35	22	226	5 x 11	2.0	A11	12	180	0.6	TYRE1V226A11ML
35	27	276	5 x 11	2.0	A11	12	180	0.6	TYRE1V276A11ML
35	33	336	5 x 11	2.0	A11	12	180	0.6	TYRE1V336A11ML
35	47	476	6.3 x 11	2.5	B11	12	290	0.25	TYRE1V476B11ML
35	56	566	6.3 x 11	2.5	B11	12	290	0.25	TYRE1V566B11ML
35	82	826	6.3 x 15	2.5	B15	12	430	0.46	TYRE1V826B15ML
35	100	107	8 x 11.5	3.5	C11	12	555	0.117	TYRE1V107C11ML
35	150	157	8 x 11.5	3.5	C11	12	555	0.117	TYRE1V157C11ML
35	220	227	8 x 15	3.5	C15	12	730	0.085	TYRE1V227C15ML
35	220	227	10 x 12.5	5.0	D12	12	755	0.09	TYRE1V227D12ML
35	330	337	8 x 20	3.5	C20	12	995	0.065	TYRE1V337C20ML
35	330	337	10 x 16	5.0	D16	12	1050	0.068	TYRE1V337D16ML
35	390	397	10 x 20	5.0	D20	12	1220	0.052	TYRE1V397D20ML
35	470	477	10 x 20	5.0	D20	12	1220	0.052	TYRE1V477D20ML
35	560	567	10 x 25	5.0	D25	12	1440	0.045	TYRE1V567D25ML
35	680	687	10 x 30	5.0	D30	12	1815	0.035	TYRE1V687D30ML
35	680	687	12.5 x 20	5.0	E20	12	1655	0.038	TYRE1V687E20ML
35	1000	108	12.5 x 25	5.0	E25	12	1945	0.03	TYRE1V108E25ML
35	1200	128	12.5 x 30	5.0	E30	12	2310	0.025	TYRE1V128E30ML
35	1200	128	16 x 20	7.5	F20	12	2205	0.029	TYRE1V128F20ML
35	1500	158	12.5 x 35	5.0	E35	12	2510	0.022	TYRE1V158E35ML

* DF measured at 120Hz, 20°C

* RC measured at 100kHz, 105°C

* ESR measured at 100kHz, 20°C

Standard Product Table (continued)

Rated Voltage V.DC	Capacitance		Case Size Dia x L	Lead Pitch	Case Code	Dissipation Factor (%)*	Ripple Current (mA)*	Impedance Max (Ω)*	Ripple Part Number
	μF	Code							
35	1500	158	16 x 25	7.5	F25	12	2555	0.022	TYRE1V158F25ML
35	1800	188	16 x 25	7.5	F25	12	2555	0.022	TYRE1V188F25ML
35	1800	188	18 x 20	7.5	G20	12	2490	0.028	TYRE1V188G20ML
35	2200	228	16 x 31.5	7.5	F31	12	3010	0.018	TYRE1V228F31ML
35	2200	228	18 x 25	7.5	G25	12	2740	0.02	TYRE1V228G25ML
35	2700	278	16 x 35.5	7.5	F35	12	3150	0.016	TYRE1V278F35ML
35	2700	278	18 x 31.5	7.5	G31	12	3635	0.016	TYRE1V278G31ML
35	3300	338	18 x 35.5	7.5	G35	12	3680	0.015	TYRE1V338G35ML
35	4700	478	18 x 40	7.5	G40	12	3800	0.014	TYRE1V478G40ML
50	4.7	475	5 x 11	2.0	A11	10	90	2.3	TYRE1H475A11ML
50	10	106	5 x 11	2.0	A11	10	120	1.4	TYRE1H106A11ML
50	18	186	5 x 11	2.0	A11	10	155	1.3	TYRE1H186A11ML
50	22	226	5 x 11	2.0	A11	10	170	1.2	TYRE1H226A11ML
50	33	336	6.3 x 11	2.5	B11	10	300	0.43	TYRE1H336B11ML
50	47	476	6.3 x 11	2.5	B11	10	300	0.43	TYRE1H476B11ML
50	56	566	6.3 x 15	2.5	B15	10	360	0.4	TYRE1H566B15ML
50	82	826	8 x 11.5	3.5	C11	10	485	0.234	TYRE1H826C11ML
50	100	107	8 x 11.5	3.5	C11	10	485	0.234	TYRE1H107C11ML
50	120	127	8 x 15	3.5	C15	10	635	0.155	TYRE1H127C15ML
50	120	127	10 x 12.5	5.0	D12	10	615	0.162	TYRE1H127D12ML
50	150	157	10 x 12.5	5.0	D12	10	860	0.162	TYRE1H157D12ML
50	180	187	8 x 20	3.5	C20	10	615	0.12	TYRE1H187C20ML
50	180	187	10 x 16	5.0	D16	10	850	0.119	TYRE1H187D16ML
50	220	227	10 x 16	5.0	D16	10	850	0.119	TYRE1H227D16ML
50	220	227	10 x 20	5.0	D20	10	1030	0.09	TYRE1H227D20ML
50	270	277	10 x 25	5.0	D25	10	1200	0.082	TYRE1H277D25ML
50	330	337	10 x 20	5.0	D20	10	1030	0.09	TYRE1H337D20ML
50	330	337	10 x 30	5.0	D30	10	1610	0.06	TYRE1H337D30ML
50	390	397	12.5 x 20	5.0	E20	10	1480	0.063	TYRE1H397E20ML
50	470	477	12.5 x 20	5.0	E20	10	1500	0.06	TYRE1H477E20ML
50	560	567	12.5 x 25	5.0	E25	10	1832	0.05	TYRE1H567E25ML
50	680	687	12.5 x 25	5.0	E25	10	1832	0.05	TYRE1H687E25ML
50	680	687	16 x 20	7.5	F20	10	1835	0.048	TYRE1H687F20ML
50	820	827	12.5 x 35	5.0	E35	10	2285	0.034	TYRE1H827E35ML
50	820	827	18 x 20	7.5	G20	10	2420	0.042	TYRE1H827G20ML
50	1000	108	16 x 25	7.5	F25	10	2235	0.034	TYRE1H108F25ML
50	1200	128	16 x 31.5	7.5	F31	10	2700	0.028	TYRE1H128F31ML
50	1200	128	18 x 25	7.5	G25	10	2610	0.029	TYRE1H128G25ML
50	1500	158	16 x 31.5	7.5	F31	10	2700	0.028	TYRE1H158F31ML
50	1500	158	16 x 35.5	7.5	F35	10	2790	0.025	TYRE1H158F35ML
50	1800	188	18 x 31.5	7.5	G31	10	3000	0.025	TYRE1H188G31ML
50	2200	228	18 x 35.5	7.5	G35	10	3100	0.023	TYRE1H228G35ML
63	4.7	475	5 x 11	2.0	A11	9	68	4.7	TYRE1J475A11ML
63	6.8	685	5 x 11	2.0	A11	9	95	2.5	TYRE1J685A11ML
63	10	106	5 x 11	2.0	A11	9	110	2.1	TYRE1J106A11ML
63	12	126	5 x 11	2.0	A11	9	145	2.0	TYRE1J126A11ML
63	15	156	6.3 x 11	2.5	B11	9	160	1.2	TYRE1J156B11ML
63	22	226	6.3 x 11	2.5	B11	9	250	0.71	TYRE1J226B11ML
63	33	336	6.3 x 11	2.5	B11	9	250	0.71	TYRE1J336B11ML
63	39	396	6.3 x 15	2.5	B15	9	330	0.7	TYRE1J396B15ML
63	47	476	8 x 11.5	3.5	C11	9	405	0.342	TYRE1J476C11ML
63	68	686	8 x 11.5	3.5	C11	9	405	0.342	TYRE1J686C11ML
63	100	107	8 x 15	3.5	C15	9	535	0.256	TYRE1J107C15ML

* DF measured at 120Hz, 20°C

* RC measured at 100kHz, 105°C

* ESR measured at 100kHz, 20°C

Standard Product Table (continued)

Rated Voltage V.DC	Capacitance		Case Size Dia x L	Lead Pitch	Case Code	Dissipation Factor (%)*	Ripple Current (mA)*	Impedance Max (Ω)*	Ripple Part Number
	μF	Code							
63	100	107	10 x 12.5	5.0	D12	9	535	0.23	TYRE1J107D12ML
63	120	127	10 x 16	5.0	D16	9	600	0.194	TYRE1J127D16ML
63	150	157	10 x 16	5.0	D16	9	660	0.194	TYRE1J157D16ML
63	180	187	10 x 20	5.0	D20	9	885	0.147	TYRE1J187D20ML
63	180	187	12.5 x 16	5.0	E16	9	1020	0.15	TYRE1J187E16ML
63	220	227	10 x 20	5.0	D20	9	885	0.147	TYRE1J227D20ML
63	220	227	10 x 25	5.0	D25	9	1020	0.13	TYRE1J227D25ML
63	270	277	16 x 16	7.5	F16	9	1410	0.09	TYRE1J277F16ML
63	330	337	12.5 x 20	5.0	E20	9	1285	0.085	TYRE1J337E20ML
63	390	397	12.5 x 25	5.0	E25	9	1720	0.07	TYRE1J397E25ML
63	390	397	18 x 16	7.5	G16	9	1690	0.086	TYRE1J397G16ML
63	470	477	12.5 x 25	5.0	E25	9	1720	0.07	TYRE1J477E25ML
63	470	477	12.5 x 30	5.0	E30	9	2090	0.055	TYRE1J477E30ML
63	470	477	16 x 20	7.5	F20	9	1765	0.059	TYRE1J477F20ML
63	560	567	16 x 25	7.5	F25	9	2160	0.05	TYRE1J567F25ML
63	680	687	12.5 x 35	5.0	E35	9	2265	0.047	TYRE1J687E35ML
63	680	687	18 x 20	7.5	G20	9	2290	0.055	TYRE1J687G20ML
63	820	827	16 x 31.5	7.5	F31	9	2670	0.043	TYRE1J827F31ML
63	820	827	18 x 25	7.5	G25	9	2585	0.043	TYRE1J827G25ML
63	1000	108	16 x 31.5	7.5	F31	9	2670	0.043	TYRE1J108F31ML
63	1000	108	16 x 35.5	7.5	F35	9	2770	0.036	TYRE1J108F35ML
63	1200	128	18 x 31.5	7.5	G31	9	2950	0.032	TYRE1J128G31ML
63	1500	158	18 x 35.5	7.5	G35	9	3095	0.03	TYRE1J158G35ML
63	2200	228	18 x 40	7.5	G40	9	3200	0.028	TYRE1J228G40ML
100	0.47	474	5 x 11	2.0	A11	8	20	43	TYRE2A474A11ML
100	1.0	105	5 x 11	2.0	A11	8	30	20	TYRE2A105A11ML
100	2.2	225	5 x 11	2.0	A11	8	44	9.8	TYRE2A225A11ML
100	3.3	335	5 x 11	2.0	A11	8	58	6.6	TYRE2A335A11ML
100	4.7	475	5 x 11	2.0	A11	8	74	4.6	TYRE2A475A11ML
100	6.8	685	5 x 11	2.0	A11	8	95	3.5	TYRE2A685A11ML
100	10	106	6.3 x 11	2.5	B11	8	130	1.8	TYRE2A106B11ML
100	15	156	8 x 11.5	3.5	C11	8	180	0.83	TYRE2A156C11ML
100	18	186	6.3 x 15	2.5	B15	8	200	0.8	TYRE2A186B15ML
100	22	226	8 x 11.5	3.5	C11	8	230	0.68	TYRE2A226C11ML
100	33	336	8 x 15	3.5	C15	8	320	0.46	TYRE2A336C15ML
100	33	336	10 x 12.5	5.0	D12	8	360	0.45	TYRE2A336D12ML
100	47	476	8 x 20	3.5	C20	8	420	0.37	TYRE2A476C20ML
100	47	476	10 x 16	5.0	D16	8	420	0.37	TYRE2A476D16ML
100	68	686	10 x 20	5.0	D20	8	490	0.3	TYRE2A686D20ML
100	82	826	10 x 25	5.0	D25	8	540	0.25	TYRE2A826D25ML
100	100	107	12.5 x 20	5.0	E20	8	580	0.18	TYRE2A107E20ML
100	150	157	12.5 x 25	5.0	E25	8	710	0.13	TYRE2A157E25ML
100	180	187	12.5 x 30	5.0	E30	8	790	0.12	TYRE2A187E30ML
100	180	187	16 x 20	7.5	F20	8	750	0.13	TYRE2A187F20ML
100	220	227	16 x 25	7.5	F25	8	890	0.1	TYRE2A227F25ML
100	220	227	18 x 20	7.5	G20	8	850	0.11	TYRE2A227G20ML
100	330	337	16 x 25	7.5	F25	8	1080	0.09	TYRE2A337F25ML
100	390	397	18 x 25	7.5	G25	8	1260	0.083	TYRE2A397G25ML
100	470	477	16 x 31.5	7.5	F31	8	1310	0.076	TYRE2A477F31ML
100	560	567	18 x 31.5	7.5	G31	8	1370	0.068	TYRE2A567G31ML
100	560	567	18 x 35.5	7.5	G35	8	1410	0.064	TYRE2A567G35ML
100	820	827	18 x 40	7.5	G40	8	1520	0.047	TYRE2A827G40ML

* DF measured at 120Hz, 20°C

* RC measured at 100kHz, 105°C

* ESR measured at 100kHz, 20°C

Dimensions

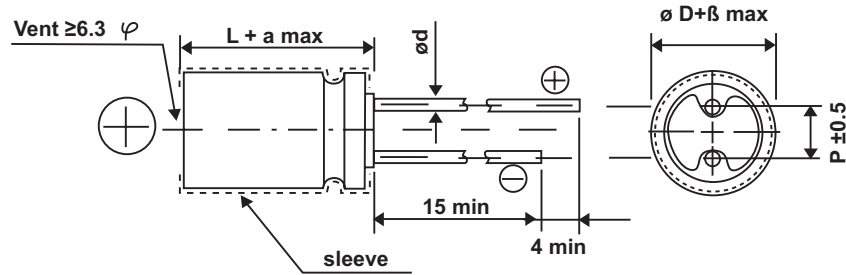

Case Code	Dimensions (mm)			
	Dia + β 0.5 max	L + a max	P±0.5	Lead dia
A11	5.0	11 +1.0	2.0	0.5
B11	6.3	11 +1.0	2.5	0.5
B15	6.3	15 +1.0	2.5	0.5
C11	8.0	11.5 +1.0	3.5	0.6
C15	8.0	15 +1.0	3.5	0.6
C20	8.0	20 +1.0	3.5	0.6
D12	10	12.5 +1.5	5.0	0.6
D16	10	16 +1.5	5.0	0.6
D20	10	20 +1.5	5.0	0.6
D25	10	25 +1.5	5.0	0.6
D30	10	30 +1.5	5.0	0.6
E16	12.5	16 +1.5	5.0	0.6
E20	12.5	20 +1.5	5.0	0.6
E25	12.5	25 +1.5	5.0	0.6
E30	12.5	30 +1.5	5.0	0.6
E35	12.5	35 +1.5	5.0	0.6
F16	16	16 +1.5	7.5	0.8
F20	16	20 +1.5	7.5	0.8
F25	16	25 +1.5	7.5	0.8
F31	16	31.5 +1.5	7.5	0.8
F35	16	35.5 +1.5	7.5	0.8
G16	18	16 +1.5	7.5	0.8
G20	18	20 +1.5	7.5	0.8
G25	18	25 +1.5	7.5	0.8
G31	18	31.5 +1.5	7.5	0.8
G35	18	35 +1.5	7.5	0.8
G40	18	40 +1.5	7.5	0.8

How to Order

TYRE	0J	226	A11	M	L
Common Part	Voltage Code	Capacitance	Case Code	Tolerance	Packaging
TYRE	0J (6.3V) 1A (10V) 1C (16V) 1E (25V) 1V (35V) 1H (50V) 1J (63V) 2A (100V)	e.g. 226	e.g. A11	M (20%)	L = Loose (bulk)

Type TYRL Series



Tyco Electronics radial leaded aluminum electrolytic capacitors are designed for through-hole PCB population where board space is restricted.

The TYRL series offers long service life over an extended temperature range from -40°C to +105°C (-25°C at 450Vdc) and high ripple current for unit size.

Suitable for a broad range of filtering, bypassing, power supply, ballast, coupling/decoupling, tele-communications and audio-video applications requiring reliability under more demanding conditions.

Key Features

- Long life polarized aluminum foil electrolytic capacitors
- Radial leads
- Aluminum case with insulating sleeve
- Up to 10000 hours load life assured
- 105°C temperature rating
- High ripple current per unit size
- RoHS Compliant

Characteristics - Electrical

		Test Conditions JIS C5101-4						
Operating Temp. Range	-40°C ~ +105°C (-25°C ~ +105°C, 450V)						—	
Rated Voltage	DC 200 ~ 450V						105°C	
Capacitance	4.7 ~ 330μF						105°C	
Capacitance Tolerance	±20%						120Hz, 20°C	
Leakage Current	Time	After 1 minute			After 5 minutes			C = rated capacitance (μF) V = rated DC working voltage (V) Temperature = 20°C
	Leakage Current	CV≤1000 I=0.1CV +40(μA)	CV>1000 I=0.04CV +100(μA)	CV≤1000 I=0.03CV +15(μA)	CV>1000 I=0.02CV +25(μA)			
Dissipation Factor (Tanδ)	Rated Voltage	200	250	350	400	450	120Hz, 20°C	
	Tanδ max	0.20	0.20	0.24	0.24	0.24		
Low Temperature Characteristics	Rated Voltage	200	250	350	400	450	120Hz	
	Impedance Ratio (max)							
	Z(-25°C)/Z(+20°C)	3	3	5	5	6		
Load Life Test	Test Time	8000 Hrs for dia. = 10mm 10000 Hrs for dia. ≥ 12.5mm					Specification satisfied when the capacitors are restored to 20°C after the rated voltage applied with rated ripple current for 8000 / 10000 hrs at 105°C	
	Capacitance Change	Within ±20% of initial value						
	Dissipation Factor	Less than 200% of specified value						
	Leakage Current	Within specified value						
Shelf Life Test	Capacitance Change	Within ±20% of initial value					Specifications satisfied when the capacitors are restored to 20°C after exposing them for 1000 hrs at 85°C without voltage applied. The rated voltage shall be applied to the capacitors before the measurements. (Refer to JIS C 5102)	
	Dissipation Factor	Less than 200% of specified value						
	Leakage Current	Less than 500% of specified value						
Ripple Current & Frequency Multipliers	Frequency (Hz)	120	1k	10k	≥100k		—	
	Dia = 10	0.25	0.61	0.88	1.0			
	Dia 12.5~18	0.35	0.66	0.89	1.0			

Product Availability Chart

Capacitance	Rated Voltage (V.DC)												
	200		250		350		400		450				
μF	Code	Dia x L	P	Dia x L	P	Dia x L	P	Dia x L	P	Dia x L	P	Dia x L	P
4.7	475									10x20	5.0		
10	106							10x20	5.0	12.5x20	5.0		
15	156							12.5x20	5.0	12.5x25	5.0		
22	226	10x20	5.0	12.5x20	5.0	12.5x20	5.0	12.5x25	5.0	16x25	7.5		
								16x20	7.5				
33	336	12.5x20	5.0	12.5x25	5.0	16x20	7.5	16x25	7.5	16x31.5	7.5	18x25	7.5
47	476	12.5x20	5.0	12.5x25	5.0	16x25	7.5	16x31.5	7.5	18x31.5	7.5		
				16x20	7.5	18x20	7.5	18x25	7.5				
68	686	12.5x25	5.0	16x25	7.5	16x31.5	7.5			18x35.5	7.5		
		16x20	7.5			18x25	7.5	18x31.5	7.5				
100	107	16x25	7.5	16x31.5	7.5	18x31.5	7.5	18x35.5	7.5				
		18x20	7.5	18x25	7.5								
150	157	16x31.5	7.5	18x31.5	7.5								
220	227	18x35.5	7.5	18x40	7.5								
330	337	18x40	7.5										

Standard Product Table

Rated Voltage V.DC	Capacitance		Case Size Dia x L	Lead Pitch	Case Code	Dissipation Factor (%)*	Ripple Current (mA)*	Part Number
	µF	Code						
200	22	226	10x20	5.0	D20	20	500	TYRL2D226D20ML
200	33	336	12.5x20	5.0	E20	20	650	TYRL2D336E20ML
200	47	476	12.5x20	5.0	E20	20	975	TYRL2D476E20ML
200	68	686	12.5x25	5.0	E25	20	1175	TYRL2D686E25ML
200	68	686	16x20	7.5	F20	20	1225	TYRL2D686F20ML
200	100	107	16x25	7.5	F25	20	1420	TYRL2D107F25ML
200	100	107	18x20	7.5	G20	20	1385	TYRL2D107G20ML
200	150	157	16x31.5	7.5	F31	20	1890	TYRL2D157F31ML
200	220	227	18x35.5	7.5	G35	20	2365	TYRL2D227G35ML
200	330	337	18x40	7.5	G40	20	3220	TYRL2D337G40ML
250	22	226	12.5x20	5.0	E20	20	500	TYRL2E226E20ML
250	33	336	12.5x25	5.0	E25	20	800	TYRL2E336E25ML
250	47	476	12.5x25	5.0	E25	20	975	TYRL2E476E25ML
250	47	476	16x20	7.5	F20	20	1015	TYRL2E476F20ML
250	68	686	16x25	7.5	F25	20	1300	TYRL2E686F25ML
250	100	107	16x31.5	7.5	F31	20	1530	TYRL2E107F31ML
250	100	107	18x25	7.5	G25	20	1480	TYRL2E107G25ML
250	150	157	18x31.5	7.5	G31	20	1935	TYRL2E157G31ML
250	220	227	18x40	7.5	G40	20	2545	TYRL2E227G40ML
350	22	226	12.5x20	5.0	E20	24	650	TYRL2V226E20ML
350	33	336	16x20	7.5	F20	24	900	TYRL2V336F20ML
350	47	476	16x25	7.5	F25	24	1075	TYRL2V476F25ML
350	47	476	18x20	7.5	G20	24	1045	TYRL2V476G20ML
350	68	686	16x31.5	7.5	F31	24	1400	TYRL2V686F31ML
350	68	686	18x25	7.5	G25	24	1375	TYRL2V686G25ML
350	100	107	18x31.5	7.5	G31	24	1575	TYRL2V107G31ML
400	10	106	10x20	5.0	D20	24	350	TYRL2G106D20ML
400	15	156	12.5x20	5.0	E20	24	550	TYRL2G156E20ML
400	22	226	12.5x25	5.0	E25	24	650	TYRL2G226E25ML
400	22	226	16x20	7.5	F20	24	680	TYRL2G226F20ML
400	33	336	16x25	7.5	F25	24	900	TYRL2G336F25ML
400	47	476	16x31.5	7.5	F31	24	1175	TYRL2G476F31ML
400	47	476	18x25	7.5	G25	24	1135	TYRL2G476G25ML
400	68	686	18x31.5	7.5	G31	24	1465	TYRL2G686G31ML
400	100	107	18x35.5	7.5	G35	24	1720	TYRL2G107G35ML
450	4.7	475	10x20	5.0	D20	24	240	TYRL2W475D20ML
450	10	106	12.5x20	5.0	E20	24	450	TYRL2W106E20ML
450	15	156	12.5x25	5.0	E25	24	600	TYRL2W156E25ML
450	22	226	16x25	7.5	F25	24	725	TYRL2W226F25ML
450	33	336	16x31.5	7.5	F31	24	975	TYRL2W336F31ML
450	33	336	18x25	7.5	G25	24	950	TYRL2W336G25ML
450	47	476	18x31.5	7.5	G31	24	1200	TYRL2W476G31ML
450	68	686	18x35.5	7.5	G35	24	1575	TYRL2W686G35ML

* DF measured at 120Hz, 20°C

* RC measured at 100kHz, 105°C

Dimensions

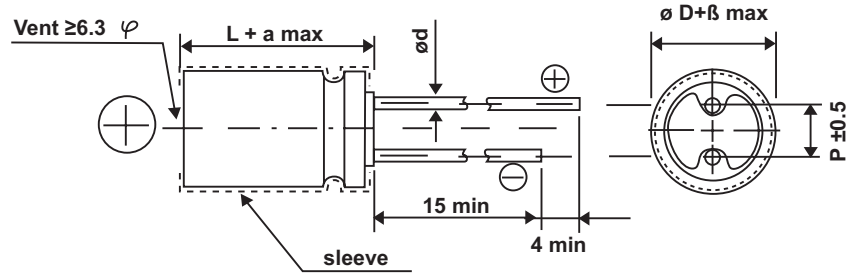

Case Code	Dimensions (mm)			
	Dia + β 0.5 max	L + a 1.5 max	P ± 0.5	Lead dia
D20	10	20	5.0	0.6
E20	12.5	20	5.0	0.6
E25	12.5	25	5.0	0.6
F20	16	20	7.5	0.8
F25	16	25	7.5	0.8
F31	16	31.5	7.5	0.8
G20	18	20	7.5	0.8
G25	18	25	7.5	0.8
G31	18	31.5	7.5	0.8
G35	18	35.5	7.5	0.8
G40	18	40	7.5	0.8

How to Order

TYRL	2D	226	D20	M	L
Common Part	Voltage Code	Capacitance	Case Code	Tolerance	Packaging
TYRL	2D (200V) 2E (250V) 2V (350V) 2G (400V) 2W (450V)	e.g. 226	e.g. D20	M (20%)	L = Loose (bulk)

Axial Leaded Aluminium Electrolytic Capacitors - Product Overview

The TYA Series Axial leaded Aluminium Electrolytic capacitors are designed for use throughout many industries in a broad range of through-hole PCB applications where board height is restricted.

The TYAV range is suitable for general purpose applications, the TYAH range is a high temperature version, up to 105 degrees Celsius, for use in more demanding situations.

- Horizontal mounting for low profile, high density PCB population
- Wide operating voltage range
- Broad range of capacitance values
- RoHS compliant

Voltage Range	Capacitance Range	Temperature Range	Load Life	Series	Page
6.3 to 450V	0.1 to 22000 μ F	-40 to +85°C	2000 hrs	TYAV	79
6.3 to 450V	0.1 to 4700 μ F	-40 to +105°C	2000 hrs	TYAH	85

Type TYAV Series



Tyco Electronics axial leaded aluminum electrolytic capacitors are designed for through-hole PCB population where mounting height is restricted.

The TYAV series offers a wide capacitance range at voltages from 6.3 to 450Vd.c.

Suitable for a broad range of general purpose filtering, by-passing, power supply coupling/decoupling, telecommunications and audio-video applications.

Key Features

- General purpose polarized aluminum foil electrolytic capacitors
- Axial leads
- Aluminum case with insulating sleeve
- 85°C temperature rating
- 2000 hours load life assured
- RoHS Compliant

Standard Product Table

Rated Voltage V.DC	Capacitance		Case Size Dia x L	Case Code	Dissipation Factor (%)*	Ripple Current (mA)*	Part Number
	µF	Code					
6.3	47	476	5 x 12	A12	23	87	TYAV0J476A12ML
6.3	100	107	6.3 x 13	B13	23	121	TYAV0J107B13ML
6.3	220	227	6.3 x 13	B13	23	215	TYAV0J227B13ML
6.3	330	337	8 x 16	C16	23	305	TYAV0J337C16ML
6.3	470	477	8 x 16	C16	23	364	TYAV0J477C16ML
6.3	1000	108	10 x 17	D17	23	662	TYAV0J108D17ML
6.3	2200	228	13 x 22	E22	23	929	TYAV0J228E22ML
6.3	3300	338	13 x 27	E27	23	1150	TYAV0J338E27ML
6.3	4700	478	13 x 27	E27	23	1354	TYAV0J478E27ML
6.3	6800	688	16 x 28	F28	23	1762	TYAV0J688F28ML
6.3	10000	109	16 x 36	F36	23	2062	TYAV0J109F36ML
6.3	22000	229	22 x 43	H43	23	3097	TYAV0J229H43ML
10	33	336	5 x 12	A12	20	78	TYAV1A336A12ML
10	47	476	5 x 12	A12	20	94	TYAV1A476A12ML
10	100	107	6.3 x 13	B13	20	145	TYAV1A107B13ML
10	220	227	8 x 13	C13	20	231	TYAV1A227C13ML
10	330	337	8 x 16	C16	20	327	TYAV1A337C16ML
10	470	477	8 x 16	C16	20	390	TYAV1A477C16ML
10	1000	108	10 x 17	D17	20	671	TYAV1A108D17ML
10	2200	228	13 x 22	E22	20	1051	TYAV1A228E22ML
10	3300	338	13 x 27	E27	20	1288	TYAV1A338E27ML
10	4700	478	16 x 28	F28	20	1552	TYAV1A478F28ML
10	6800	688	16 x 33	F33	20	1930	TYAV1A688F33ML
10	10000	109	18 x 36	G36	20	2122	TYAV1A109G36ML
16	22	226	5 x 12	A12	17	71	TYAV1C226A12ML
16	33	336	5 x 12	A12	17	85	TYAV1C336A12ML
16	47	476	6.3 x 13	B13	17	88	TYAV1C476B13ML
16	100	107	6.3 x 13	B13	17	160	TYAV1C107B13ML
16	220	227	8 x 13	C13	17	298	TYAV1C227C13ML
16	330	337	8 x 16	C16	17	365	TYAV1C337C16ML
16	470	477	8 x 16	C16	17	460	TYAV1C477C16ML
16	1000	108	10 x 21	D21	17	775	TYAV1C108D21ML
16	2200	228	13 x 24	E24	17	1125	TYAV1C228E24ML
16	3300	338	16 x 28	F28	17	1454	TYAV1C338F28ML
16	4700	478	16 x 33	F33	17	1650	TYAV1C478F33ML
16	6800	688	18 x 36	G36	17	2040	TYAV1C688G36ML
16	10000	109	18 x 42	G42	17	2503	TYAV1C109G42ML
25	10	106	5 x 12	A12	15	40	TYAV1E106A12ML
25	22	226	5 x 12	A12	15	76	TYAV1E226A12ML
25	33	336	5 x 12	A12	15	80	TYAV1E336A12ML
25	47	476	6.3 x 13	B13	15	100	TYAV1E476B13ML
25	100	107	8 x 13	C13	15	215	TYAV1E107C13ML
25	220	227	8 x 16	C16	15	319	TYAV1E227C16ML
25	330	337	10 x 17	D17	15	454	TYAV1E337D17ML
25	470	477	10 x 21	D21	15	524	TYAV1E477D21ML
25	1000	108	13 x 22	E22	15	873	TYAV1E108E22ML
25	2200	228	16 x 28	F28	15	1344	TYAV1E228F28ML
25	3300	338	16 x 33	F33	15	1611	TYAV1E338F33ML
25	4700	478	18 x 36	G36	15	1881	TYAV1E478G36ML
25	6800	688	18 x 42	G42	15	2170	TYAV1E688G42ML
25	10000	109	22 x 43	H43	15	2893	TYAV1E109H43ML

* DF measured at 120Hz, 20°C

* RC measured at 120Hz, 85°C

Standard Product Table (continued)

Rated Voltage V.DC	Capacitance		Case Size Dia x L	Case Code	Dissipation Factor (%) [*]	Ripple Current (mA) [*]	Part Number
	µF	Code					
35	10	106	5 x 12	A12	12	55	TYAV1V106A12ML
35	22	226	6.3 x 13	B13	12	70	TYAV1V226B13ML
35	33	336	6.3 x 13	B13	12	115	TYAV1V336B13ML
35	47	476	6.3 x 13	B13	12	138	TYAV1V476B13ML
35	100	107	8 x 16	C16	12	232	TYAV1V107C16ML
35	220	227	10 x 17	D17	12	401	TYAV1V227D17ML
35	330	337	10 x 21	D21	12	514	TYAV1V337D21ML
35	470	477	13 x 22	E22	12	613	TYAV1V477E22ML
35	1000	108	13 x 27	E27	12	955	TYAV1V108E27ML
35	2200	228	16 x 33	F33	12	1421	TYAV1V228F33ML
35	3300	338	18 x 36	G36	12	1640	TYAV1V338G36ML
35	4700	478	22 x 43	H43	12	2280	TYAV1V478H43ML
35	6800	688	22 x 43	H43	12	2470	TYAV1V688H43ML
35	10000	109	25 x 52	J52	12	3180	TYAV1V109J52ML
50	0.1	104	5 x 12	A12	10	1.5	TYAV1H104A12ML
50	0.22	224	5 x 12	A12	10	3.5	TYAV1H224A12ML
50	0.33	334	5 x 12	A12	10	5.0	TYAV1H334A12ML
50	0.47	474	5 x 12	A12	10	6.0	TYAV1H474A12ML
50	1.0	105	5 x 12	A12	10	10	TYAV1H105A12ML
50	2.2	225	5 x 12	A12	10	20	TYAV1H225A12ML
50	3.3	335	5 x 12	A12	10	30	TYAV1H335A12ML
50	4.7	475	5 x 12	A12	10	42	TYAV1H475A12ML
50	10	106	5 x 12	A12	10	50	TYAV1H106A12ML
50	22	226	6.3 x 13	B13	10	85	TYAV1H226B13ML
50	33	336	6.3 x 13	B13	10	126	TYAV1H336B13ML
50	47	476	8 x 13	C13	10	174	TYAV1H476C13ML
50	100	107	10 x 17	D17	10	296	TYAV1H107D17ML
50	220	227	10 x 21	D21	10	459	TYAV1H227D21ML
50	330	337	13 x 22	E22	10	613	TYAV1H337E22ML
50	470	477	13 x 22	E22	10	731	TYAV1H477E22ML
50	1000	108	16 x 33	F33	10	1111	TYAV1H108F33ML
50	2200	228	18 x 36	G36	10	1699	TYAV1H228G36ML
50	3300	338	22 x 43	H43	10	2027	TYAV1H338H43ML
50	4700	478	25 x 43	J43	10	2347	TYAV1H478J43ML
50	6800	688	25 x 52	J52	10	2650	TYAV1H688J52ML
50	10000	109	25 x 52	J52	10	2650	TYAV1H109J52ML
63	0.1	104	5 x 12	A12	9	3.0	TYAV1J104A12ML
63	0.22	224	5 x 12	A12	9	4.5	TYAV1J224A12ML
63	0.33	334	5 x 12	A12	9	7.5	TYAV1J334A12ML
63	0.47	474	5 x 12	A12	9	9.0	TYAV1J474A12ML
63	1.0	105	5 x 12	A12	9	15	TYAV1J105A12ML
63	2.2	225	5 x 12	A12	9	30	TYAV1J225A12ML
63	3.3	335	5 x 12	A12	9	36	TYAV1J335A12ML
63	4.7	475	5 x 12	A12	9	44	TYAV1J475A12ML
63	10	106	6.3 x 13	B13	9	55	TYAV1J106B13ML
63	22	226	6.3 x 13	B13	9	109	TYAV1J226B13ML
63	33	336	8 x 13	C13	9	154	TYAV1J336C13ML
63	47	476	8 x 16	C16	9	214	TYAV1J476C16ML
63	100	107	10 x 17	D17	9	326	TYAV1J107D17ML
63	220	227	13 x 22	E22	9	527	TYAV1J227E22ML
63	330	337	13 x 22	E22	9	675	TYAV1J337E22ML
63	470	477	13 x 27	E27	9	780	TYAV1J477E27ML
63	1000	108	16 x 36	F36	9	1249	TYAV1J108F36ML

* DF measured at 120Hz, 20°C

* RC measured at 120Hz, 85°C

Standard Product Table (continued)

Rated Voltage V.DC	Capacitance		Case Size Dia x L	Case Code	Dissipation Factor (%)*	Ripple Current (mA)*	Part Number
	µF	Code					
63	2200	228	22 x 43	H43	9	1744	TYAV1J228H43ML
63	3300	338	25 x 52	J52	9	2309	TYAV1J338J52ML
63	4700	478	25 x 52	J52	9	2710	TYAV1J478J52ML
63	6800	688	25 x 52	J52	9	2710	TYAV1J688J52ML
100	0.1	104	5 x 12	A12	8	3.0	TYAV2A104A12ML
100	0.22	224	5 x 12	A12	8	5.0	TYAV2A224A12ML
100	0.33	334	5 x 12	A12	8	8.0	TYAV2A334A12ML
100	0.47	474	5 x 12	A12	8	9.0	TYAV2A474A12ML
100	1.0	105	5 x 12	A12	8	15	TYAV2A105A12ML
100	2.2	225	5 x 12	A12	8	30	TYAV2A225A12ML
100	3.3	335	5 x 12	A12	8	41	TYAV2A335A12ML
100	4.7	475	6.3 x 13	B13	8	40	TYAV2A475B13ML
100	10	106	6.3 x 13	B13	8	72	TYAV2A106B13ML
100	22	226	8 x 16	C16	8	133	TYAV2A226C16ML
100	33	336	10 x 17	D17	8	190	TYAV2A336D17ML
100	47	476	10 x 21	D21	8	237	TYAV2A476D21ML
100	100	107	13 x 22	E22	8	377	TYAV2A107E22ML
100	220	227	16 x 28	F28	8	625	TYAV2A227F28ML
100	330	337	16 x 33	F33	8	793	TYAV2A337F33ML
100	470	477	16 x 36	F36	8	942	TYAV2A477F36ML
100	1000	108	18 x 42	G42	8	1359	TYAV2A108G42ML
100	2200	228	25 x 52	J52	8	2430	TYAV2A228J52ML
160	1.0	105	6.3 x 13	B13	12	7.0	TYAV2C105B13ML
160	2.2	225	6.3 x 13	B13	12	15	TYAV2C225B13ML
160	3.3	335	8 x 13	C13	12	21	TYAV2C335C13ML
160	4.7	475	8 x 16	C16	12	31	TYAV2C475C16ML
160	10	106	10 x 17	D17	12	60	TYAV2C106D17ML
160	22	226	10 x 21	D21	12	121	TYAV2C226D21ML
160	33	336	13 x 22	E22	12	154	TYAV2C336E22ML
160	47	476	13 x 27	E27	12	198	TYAV2C476E27ML
160	100	107	16 x 33	F33	12	345	TYAV2C107F33ML
160	220	227	18 x 42	G42	12	586	TYAV2C227G42ML
160	330	337	22 x 43	H43	12	632	TYAV2C337H43ML
200	1.0	105	6.3 x 13	B13	14	9.0	TYAV2D105B13ML
200	2.2	225	8 x 13	C13	14	16	TYAV2D225C13ML
200	3.3	335	8 x 16	C16	14	26	TYAV2D335C16ML
200	4.7	475	10 x 17	D17	14	33	TYAV2D475D17ML
200	10	106	10 x 21	D21	14	66	TYAV2D106D21ML
200	22	226	13 x 22	E22	14	121	TYAV2D226E22ML
200	33	336	13 x 27	E27	14	167	TYAV2D336E27ML
200	47	476	16 x 33	F33	14	214	TYAV2D476F33ML
200	100	107	16 x 36	F36	14	368	TYAV2D107F36ML
200	220	227	22 x 43	H43	14	609	TYAV2D227H43ML
250	1.0	105	6.3 x 13	B13	17	12	TYAV2E105B13ML
250	2.2	225	8 x 16	C16	17	17	TYAV2E225C16ML
250	3.3	335	8 x 21	C21	17	31	TYAV2E335C21ML
250	4.7	475	10 x 17	D17	17	38	TYAV2E475D17ML
250	10	106	10 x 21	D21	17	72	TYAV2E106D21ML
250	22	226	13 x 27	E27	17	126	TYAV2E226E27ML
250	33	336	16 x 28	F28	17	178	TYAV2E336F28ML
250	47	476	16 x 33	F33	17	241	TYAV2E476F33ML
250	100	107	16 x 42	F42	17	391	TYAV2E107F42ML
250	220	227	22 x 43	H43	17	632	TYAV2E227H43ML

* DF measured at 120Hz, 20°C

* RC measured at 120Hz, 85°C

Standard Product Table (continued)

Rated Voltage V.DC	Capacitance		Case Size Dia x L	Case Code	Dissipation Factor (%) [*]	Ripple Current (mA) [*]	Part Number
	μF	Code					
350	1.0	105	8 x 16	C16	20	13	TYAV2V105C16ML
350	2.2	225	8 x 21	C21	20	19	TYAV2V225C21ML
350	3.3	335	8 x 21	C21	20	33	TYAV2V335C21ML
350	4.7	475	10 x 21	D21	20	44	TYAV2V475D21ML
350	10	106	13 x 22	E22	20	72	TYAV2V106E22ML
350	22	226	13 x 27	E27	20	132	TYAV2V226E27ML
350	33	336	16 x 33	F33	20	186	TYAV2V336F33ML
350	47	476	16 x 42	F42	20	253	TYAV2V476F42ML
350	100	107	22 x 43	H43	20	402	TYAV2V107H43ML
400	1.0	105	8 x 16	C16	24	14	TYAV2G105C16ML
400	2.2	225	10 x 17	D17	24	21	TYAV2G225D17ML
400	3.3	335	10 x 17	D17	24	34	TYAV2G335D17ML
400	4.7	475	10 x 26	D26	24	45	TYAV2G475D26ML
400	10	106	13 x 22	E22	24	80	TYAV2G106E22ML
400	22	226	16 x 33	F33	24	137	TYAV2G226F33ML
400	33	336	16 x 36	F36	24	192	TYAV2G336F36ML
400	47	476	18 x 42	G42	24	339	TYAV2G476G42ML
400	100	107	25 x 43	J43	24	424	TYAV2G107J43ML
450	1.0	105	8 x 16	C16	24	15	TYAV2W105C16ML
450	2.2	225	10 x 21	D21	24	23	TYAV2W225D21ML
450	3.3	335	10 x 21	D21	24	36	TYAV2W335D21ML
450	4.7	475	10 x 26	D26	24	46	TYAV2W475D26ML
450	10	106	13 x 27	E27	24	82	TYAV2W106E27ML
450	22	226	16 x 36	F36	24	143	TYAV2W226F36ML
450	33	336	16 x 42	F42	24	201	TYAV2W336F42ML
450	47	476	18 x 42	G42	24	339	TYAV2W476G42ML
450	100	107	25 x 52	J52	24	448	TYAV2W107J52ML

* DF measured at 120Hz, 20°C

* RC measured at 120Hz, 85°C

Characteristics - Electrical

		Test Cond. JIS C5101-4, Characteristic W														
Operating Temp. Range	-40°C ~ +85°C	—														
Rated Voltage	DC 6.3 ~ 450V	85°C														
Capacitance	0.1 ~ 22000μF	85°C														
Capacitance Tolerance	±20%	120Hz, 20°C														
Leakage Current	Rated Voltage	≤100V					>100V									C = rated capacitance (μF) V = rated DC working voltage (V) Temperature = 20°C
	Time	after 2 minutes					after 5 minutes									
	Leakage Current	I = 0.02CV or 3 (μA) whichever is greater					CV ≤1000 I = 0.03CV + 15 (μA)			CV >1000 I = 0.02CV + 25 (μA)						
Dissipation Factor (Tanδ)	Rated Voltage	6.3	10	16	25	35	50	63	100	160	200	250	350	400	450	120Hz, 20°C
	Tanδ max	0.23	0.20	0.17	0.15	0.12	0.10	0.09	0.08	0.12	0.14	0.17	0.20	0.24	0.24	
Low Temperature Characteristics	Rated Voltage	6.3	10	16	25	35	50	63	100	160	200	250	350	400	450	120Hz
	Impedance Ratio															
	Z(-25°C)/∅D<16	6	4	3	3	2	2	2	2	3	6	8	12	14	16	
	Z(+20°C)/∅D≥16	8	6	4	4	3	3	3	3	4	8	10	—	—	—	
	Z(-40°C)/∅D<16	10	8	6	6	4	3	3	3	4	8	10	—	—	—	
Z(+20°C)/∅D≥16	18	16	12	10	8	8	6	6	4	8	10	—	—	—		
Load Life Test	Test Time	2000 Hrs														
	Capacitance Change	Within ±20% of initial value														
	Dissipation Factor	Less than 200% of specified value														
	Leakage Current	Within specified value														
Shelf Life Test	Test Time	1000 hrs														
	Capacitance Change	Within ±20% of initial value														
	Dissipation Factor	Less than 200% of specified value														
	Leakage Current	Within specified value														
Ripple Current & Multipliers Frequency	Frequency (Hz)	60(50)			120			500			1k			≥10k		
	C (μF) < 100	0.70			1.00			1.30			1.40			1.50		
	C (μF) 100 ~ 1000	0.75			1.00			1.20			1.30			1.35		
	C (μF) >1000	0.80			1.00			1.10			1.12			1.15		

Product Availability Chart

Capacitance		Rated Voltage (V.DC)															
		6.3	10	16	25	35	50	63	100	160	200	250	350	400	450		
μF	Code	Dia x L	Dia x L	Dia x L	Dia x L	Dia x L	Dia x L	Dia x L	Dia x L	Dia x L	Dia x L	Dia x L	Dia x L	Dia x L	Dia x L		
0.1	104							5x12	5x12	5x12							
0.22	224							5x12	5x12	5x12							
0.33	334							5x12	5x12	5x12							
0.47	474							5x12	5x12	5x12							
1.0	105							5x12	5x12	5x12	6.3x13	6.3x13	6.3x13	8x16	8x16	8x16	
2.2	225							5x12	5x12	5x12	6.3x13	8x13	8x16	8x21	10x17	10x21	
3.3	335							5x12	5x12	5x12	8x13	8x16	8x21	8x21	10x17	10x21	
4.7	475							5x12	5x12	6.3x13	8x16	10x17	10x17	10x21	10x26	10x26	
10	106					5x12	5x12	5x12	6.3x13	6.3x13	6.3x13	10x17	10x21	10x21	13x22	13x22	13x27
22	226				5x12	5x12	6.3x13	6.3x13	6.3x13	8x16	10x21	13x22	13x27	13x27	13x27	16x33	16x36
33	336			5x12	5x12	5x12	6.3x13	6.3x13	8x13	10x17	13x22	13x27	16x28	16x33	16x36	16x42	
47	476	5x12	5x12	6.3x13	6.3x13	6.3x13	8x13	8x16	10x21	13x27	16x33	16x33	16x42	18x42	18x42		
100	107	6.3x13	6.3x13	6.3x13	8x13	8x16	10x17	10x17	13x22	16x33	16x36	16x42	22x43	25x43	25x52		
220	227	6.3x13	8x13	8x13	8x16	10x17	10x21	13x22	16x28	18x42	22x43	22x43					
330	337	8x16	8x16	8x16	10x17	10x21	13x22	13x22	16x33	22x43							
470	477	8x16	8x16	8x16	10x21	13x22	13x22	13x27	16x36								
1000	108	10x17	10x17	10x21	13x22	13x27	16x33	16x36	18x42								
2200	228	13x22	13x22	13x24	16x28	16x33	18x36	22x43	25x52								
3300	338	13x27	13x27	16x28	16x33	18x36	22x43	25x52									
4700	478	13x27	16x28	16x33	18x36	22x43	25x43	25x52									
6800	688	16x28	16x33	18x36	18x42	22x43	25x52	25x52									
10000	109	16x36	18x36	18x42	22x43	25x52	25x52										
22000	229	22x43															

Dimensions

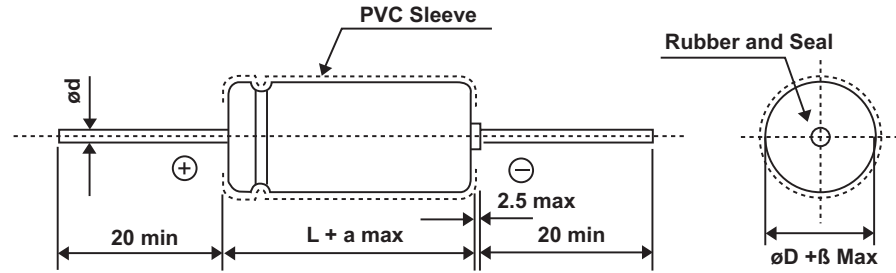

Case Code	Dimensions (mm)		
	Dia + β max	L + a max	Lead dia +0.1max
A12	5.0 +0.5	12 +1.5	0.6
B13	6.3 +0.5	13 +1.5	0.6
C13	8.0 +0.5	13 +1.5	0.6
C16	8.0 +0.5	16 +1.5	0.6
C21	8.0 +0.5	21 +1.5	0.6
D17	10 +1.0	17 +2.0	0.6
D21	10 +1.0	21 +2.0	0.6
D26	10 +1.0	26 +2.0	0.6
E22	13 +1.0	22 +2.0	0.6
E24	13 +1.0	24 +2.0	0.6
E27	13 +1.0	27 +2.0	0.6
F28	16 +1.0	28 +2.0	0.8
F33	16 +1.0	33 +2.0	0.8
F36	16 +1.0	36 +2.0	0.8
F42	16 +1.0	42 +2.0	0.8
G36	18 +1.0	36 +2.0	0.8
G42	18 +1.0	42 +2.0	0.8
H43	22 +1.0	43 +2.0	0.8
J43	25 +1.0	43 +2.0	0.8
J52	25 +1.0	52 +2.0	0.8

How to Order

TYAV	0J	476	A12	M	L
Common Part	Voltage Code	Capacitance	Case Code	Tolerance	Packaging
TYAV	0J (6.3V) 1A (10V) 1C (16V) 1E (25V) 1V (35V) 1H (50V) 1J (63V) 2A (100V) 2C (160V) 2D (200V) 2E (250V) 2V (350V) 2G (400V) 2W (450V)	e.g. 476	e.g. A12	M (20%)	L = Loose (bulk)

Type TYAH Series

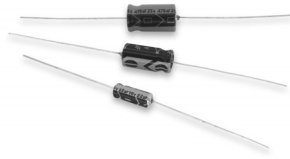

Tyco Electronics axial leaded aluminum electrolytic capacitors are designed for through-hole PCB population where mounting height is restricted.

The TYAH series offers an extended temperature range from -40°C to +105°C.

Suitable for a broad range of filtering, bypassing, power supply coupling / decoupling, telecommunications and audio-video applications requiring reliability under more demanding conditions.

Key Features

- High temperature polarized aluminum foil electrolytic capacitors
- Axial leads
- Aluminum case with insulating sleeve
- 105°C temperature rating
- 2000 hours load life assured
- RoHS Compliant

Standard Product Table

Rated Voltage V.DC	Capacitance		Case Size Dia x L	Case Code	Dissipation Factor (%)*	Ripple Current (mA)*	Part Number
	µF	Code					
6.3	100	107	6.3 x 13	B13	23	102	TYAH0J107B13ML
6.3	220	227	6.3 x 13	B13	23	167	TYAH0J227B13ML
6.3	330	337	8 x 16	C16	23	236	TYAH0J337C16ML
6.3	470	477	8 x 16	C16	23	281	TYAH0J477C16ML
6.3	1000	108	10 x 17	D17	23	453	TYAH0J108D17ML
6.3	2200	228	13 x 22	E22	23	740	TYAH0J228E22ML
6.3	3300	338	13 x 22	E22	23	906	TYAH0J338E22ML
6.3	4700	478	13 x 27	E27	23	1168	TYAH0J478E27ML
10	33	336	5 x 12	A12	20	60	TYAH1A336A12ML
10	47	476	5 x 12	A12	20	77	TYAH1A476A12ML
10	100	107	6.3 x 13	B13	20	110	TYAH1A107B13ML
10	220	227	8 x 13	C13	20	180	TYAH1A227C13ML
10	330	337	8 x 16	C16	20	253	TYAH1A337C16ML
10	470	477	8 x 16	C16	20	302	TYAH1A477C16ML
10	1000	108	10 x 17	D17	20	486	TYAH1A108D17ML
10	2200	228	13 x 22	E22	20	793	TYAH1A228E22ML
10	3300	338	13 x 27	E27	20	1015	TYAH1A338E27ML
10	4700	478	16 x 28	F28	20	1252	TYAH1A478F28ML
16	10	106	5 x 12	A12	17	35	TYAH1C106A12ML
16	22	226	5 x 12	A12	17	55	TYAH1C226A12ML
16	33	336	5 x 12	A12	17	73	TYAH1C336A12ML
16	47	476	6.3 x 13	B13	17	85	TYAH1C476B13ML
16	100	107	6.3 x 13	B13	17	145	TYAH1C107B13ML
16	220	227	8 x 13	C13	17	231	TYAH1C227C13ML
16	330	337	8 x 16	C16	17	323	TYAH1C337C16ML
16	470	477	10 x 17	D17	17	359	TYAH1C477D17ML
16	1000	108	10 x 21	D21	17	569	TYAH1C108D21ML
16	2200	228	13 x 24	E24	17	926	TYAH1C228E24ML
16	3300	338	16 x 28	F28	17	1173	TYAH1C338F28ML
16	4700	478	16 x 33	F33	17	1443	TYAH1C478F33ML
25	10	106	5 x 12	A12	15	39	TYAH1E106A12ML
25	22	226	5 x 12	A12	15	63	TYAH1E226A12ML
25	33	336	5 x 12	A12	15	75	TYAH1E336A12ML
25	47	476	6.3 x 13	B13	15	90	TYAH1E476B13ML
25	100	107	8 x 13	C13	15	166	TYAH1E107C13ML
25	220	227	8 x 16	C16	15	246	TYAH1E227C16ML
25	330	337	10 x 17	D17	15	345	TYAH1E337D17ML
25	470	477	10 x 21	D21	15	432	TYAH1E477D21ML
25	1000	108	13 x 22	E22	15	662	TYAH1E108E22ML
25	2200	228	16 x 28	F28	15	1024	TYAH1E228F28ML
25	3300	338	16 x 33	F33	15	1300	TYAH1E338F33ML
25	4700	478	18 x 36	G36	15	1638	TYAH1E478G36ML
35	10	106	5 x 12	A12	12	44	TYAH1V106A12ML
35	22	226	6.3 x 13	B13	12	65	TYAH1V226B13ML
35	33	336	6.3 x 13	B13	12	96	TYAH1V336B13ML
35	47	476	6.3 x 13	B13	12	114	TYAH1V476B13ML
35	100	107	8 x 16	C16	12	180	TYAH1V107C16ML
35	220	227	10 x 17	D17	12	305	TYAH1V227D17ML
35	330	337	10 x 21	D21	12	391	TYAH1V337D21ML
35	470	477	13 x 22	E22	12	490	TYAH1V477E22ML
35	1000	108	13 x 27	E27	12	721	TYAH1V108E27ML
35	2200	228	16 x 33	F33	12	1177	TYAH1V228F33ML
35	3300	338	18 x 36	G36	12	1449	TYAH1V338G36ML
35	4700	478	22 x 43	H43	12	1878	TYAH1V478H43ML

* DF measured at 120Hz, 20°C

* RC measured at 120Hz, 105°C

Standard Product Table (continued)

Rated Voltage V.DC	Capacitance		Case Size Dia x L	Case Code	Dissipation Factor (%)*	Ripple Current (mA)*	Part Number
	µF	Code					
50	0.1	104	5 x 12	A12	10	2.0	TYAH1H104A12ML
50	0.22	224	5 x 12	A12	10	3.5	TYAH1H224A12ML
50	0.33	334	5 x 12	A12	10	5.0	TYAH1H334A12ML
50	0.47	474	5 x 12	A12	10	6.0	TYAH1H474A12ML
50	1.0	105	5 x 12	A12	10	10	TYAH1H105A12ML
50	2.2	225	5 x 12	A12	10	20	TYAH1H225A12ML
50	3.3	335	5 x 12	A12	10	30	TYAH1H335A12ML
50	4.7	475	5 x 12	A12	10	34	TYAH1H475A12ML
50	10	106	5 x 12	A12	10	50	TYAH1H106A12ML
50	22	226	6.3 x 13	B13	10	75	TYAH1H226B13ML
50	33	336	6.3 x 13	B13	10	105	TYAH1H336B13ML
50	47	476	8 x 13	C13	10	140	TYAH1H476C13ML
50	100	107	10 x 17	D17	10	225	TYAH1H107D17ML
50	220	227	10 x 21	D21	10	349	TYAH1H227D21ML
50	330	337	13 x 22	E22	10	450	TYAH1H337E22ML
50	470	477	13 x 22	E22	10	561	TYAH1H477E22ML
50	1000	108	16 x 33	F33	10	875	TYAH1H108F33ML
50	2200	228	18 x 36	G36	10	1408	TYAH1H228G36ML
50	3300	338	22 x 43	H43	10	1724	TYAH1H338H43ML
50	4700	478	25 x 43	J43	10	1950	TYAH1H478J43ML
63	0.1	104	5 x 12	A12	9	3.0	TYAH1J104A12ML
63	0.22	224	5 x 12	A12	9	4.5	TYAH1J224A12ML
63	0.33	334	5 x 12	A12	9	7.5	TYAH1J334A12ML
63	0.47	474	5 x 12	A12	9	9.0	TYAH1J474A12ML
63	1.0	105	5 x 12	A12	9	15	TYAH1J105A12ML
63	2.2	225	5 x 12	A12	9	30	TYAH1J225A12ML
63	3.3	335	5 x 12	A12	9	32	TYAH1J335A12ML
63	4.7	475	5 x 12	A12	9	36	TYAH1J475A12ML
63	10	106	6.3 x 13	B13	9	55	TYAH1J106B13ML
63	22	226	6.3 x 13	B13	9	90	TYAH1J226B13ML
63	33	336	8 x 13	C13	9	123	TYAH1J336C13ML
63	47	476	8 x 16	C16	9	162	TYAH1J476C16ML
63	100	107	10 x 17	D17	9	248	TYAH1J107D17ML
63	220	227	13 x 22	E22	9	420	TYAH1J227E22ML
63	330	337	13 x 22	E22	9	495	TYAH1J337E22ML
63	470	477	13 x 27	E27	9	632	TYAH1J477E27ML
63	1000	108	16 x 36	F36	9	984	TYAH1J108F36ML
63	2200	228	22 x 43	H43	9	1540	TYAH1J228H43ML
63	3300	338	25 x 52	J52	9	1950	TYAH1J338J52ML
63	4700	478	25 x 52	J52	9	2290	TYAH1J478J52ML
100	0.1	104	5 x 12	A12	8	3.0	TYAH2A104A12ML
100	0.22	224	5 x 12	A12	8	5.0	TYAH2A224A12ML
100	0.33	334	5 x 12	A12	8	8.0	TYAH2A334A12ML
100	0.47	474	5 x 12	A12	8	9.0	TYAH2A474A12ML
100	1.0	105	5 x 12	A12	8	15	TYAH2A105A12ML
100	2.2	225	5 x 12	A12	8	30	TYAH2A225A12ML
100	3.3	335	5 x 12	A12	8	32	TYAH2A335A12ML
100	4.7	475	6.3 x 13	B13	8	37	TYAH2A475B13ML
100	10	106	6.3 x 13	B13	8	64	TYAH2A106B13ML
100	22	226	8 x 16	C16	8	106	TYAH2A226C16ML
100	33	336	10 x 17	D17	8	150	TYAH2A336D17ML
100	47	476	10 x 21	D21	8	180	TYAH2A476D21ML
100	100	107	13 x 22	E22	8	287	TYAH2A107E22ML

* DF measured at 120Hz, 20°C

* RC measured at 120Hz, 105°C

Standard Product Table (continued)

Rated Voltage V.DC	Capacitance		Case Size Dia x L	Case Code	Dissipation Factor (%)*	Ripple Current (mA)*	Part Number
	µF	Code					
100	220	227	16 x 28	F28	8	458	TYAH2A227F28ML
100	330	337	16 x 33	F33	8	582	TYAH2A337F33ML
100	470	477	16 x 36	F36	8	713	TYAH2A477F36ML
100	1000	108	18 x 42	G42	8	1096	TYAH2A108G42ML
100	2200	228	25 x 52	J52	8	2310	TYAH2A228J52ML
160	1.0	105	6.3 x 13	B13	12	7.0	TYAH2C105B13ML
160	2.2	225	6.3 x 13	B13	12	15	TYAH2C225B13ML
160	3.3	335	8 x 16	C16	12	21	TYAH2C335C16ML
160	4.7	475	8 x 16	C16	12	31	TYAH2C475C16ML
160	10	106	10 x 17	D17	12	60	TYAH2C106D17ML
160	22	226	10 x 21	D21	12	121	TYAH2C226D21ML
160	33	336	13 x 22	E22	12	154	TYAH2C336E22ML
160	47	476	13 x 27	E27	12	198	TYAH2C476E27ML
160	100	107	16 x 33	F33	12	345	TYAH2C107F33ML
160	220	227	18 x 42	G42	12	586	TYAH2C227G42ML
160	330	337	22 x 43	H43	12	632	TYAH2C337H43ML
200	1.0	105	6.3 x 13	B13	14	9.0	TYAH2D105B13ML
200	2.2	225	8 x 13	C13	14	16	TYAH2D225C13ML
200	3.3	335	8 x 16	C16	14	26	TYAH2D335C16ML
200	4.7	475	10 x 17	D17	14	33	TYAH2D475D17ML
200	10	106	10 x 21	D21	14	66	TYAH2D106D21ML
200	22	226	13 x 22	E22	14	121	TYAH2D226E22ML
200	33	336	13 x 27	E27	14	167	TYAH2D336E27ML
200	47	476	16 x 33	F33	14	214	TYAH2D476F33ML
200	100	107	16 x 36	F36	14	368	TYAH2D107F36ML
200	220	227	22 x 43	H43	14	609	TYAH2D227H43ML
250	1.0	105	6.3 x 13	B13	17	12	TYAH2E105B13ML
250	2.2	225	8 x 16	C16	17	17	TYAH2E225C16ML
250	3.3	335	8 x 21	C21	17	31	TYAH2E335C21ML
250	4.7	475	10 x 17	D17	17	38	TYAH2E475D17ML
250	10	106	10 x 21	D21	17	72	TYAH2E106D21ML
250	22	226	13 x 27	E27	17	126	TYAH2E226E27ML
250	33	336	16 x 28	F28	17	178	TYAH2E336F28ML
250	47	476	16 x 33	F33	17	241	TYAH2E476F33ML
250	100	107	16 x 42	F42	17	391	TYAH2E107F42ML
250	220	227	22 x 43	H43	17	632	TYAH2E227H43ML
350	1.0	105	8 x 16	C16	20	13	TYAH2V105C16ML
350	2.2	225	8 x 21	C21	20	19	TYAH2V225C21ML
350	3.3	335	8 x 21	C21	20	33	TYAH2V335C21ML
350	4.7	475	10 x 21	D21	20	44	TYAH2V475D21ML
350	10	106	13 x 22	E22	20	72	TYAH2V106E22ML
350	22	226	13 x 27	E27	20	132	TYAH2V226E27ML
350	33	336	16 x 33	F33	20	186	TYAH2V336F33ML
350	47	476	16 x 42	F42	20	253	TYAH2V476F42ML
350	100	107	22 x 43	H43	20	402	TYAH2V107H43ML

* DF measured at 120Hz, 20°C

* RC measured at 120Hz, 105°C

Standard Product Table (continued)

Rated Voltage V.DC	Capacitance		Case Size Dia x L	Case Code	Dissipation Factor (%)*	Ripple Current (mA)*	Part Number
	µF	Code					
400	1.0	105	8 x 16	C16	25	15	TYAH2G105C16ML
400	2.2	225	10 x 17	D17	25	23	TYAH2G225D17ML
400	3.3	335	10 x 17	D17	25	36	TYAH2G335D17ML
400	4.7	475	10 x 26	D26	25	46	TYAH2G475D26ML
400	10	106	13 x 22	E22	25	79	TYAH2G106E22ML
400	22	226	16 x 33	F33	25	143	TYAH2G226F33ML
400	33	336	16 x 42	F42	25	201	TYAH2G336F42ML
400	47	476	18 x 42	G42	25	253	TYAH2G476G42ML
400	100	107	25 x 43	J43	25	439	TYAH2G107J43ML
450	1.0	105	8 x 16	C16	25	15	TYAH2W105C16ML
450	2.2	225	10 x 21	D21	25	23	TYAH2W225D21ML
450	3.3	335	10 x 21	D21	25	36	TYAH2W335D21ML
450	4.7	475	10 x 26	D26	25	46	TYAH2W475D26ML
450	10	106	13 x 27	E27	25	82	TYAH2W106E27ML
450	22	226	16 x 36	F36	25	154	TYAH2W226F36ML
450	33	336	16 x 42	F42	25	201	TYAH2W336F42ML
450	47	476	18 x 42	G42	25	304	TYAH2W476G42ML
450	100	107	25 x 52	J52	25	448	TYAH2W107J52ML

* DF measured at 120Hz, 20°C

* RC measured at 120Hz, 105°C

Characteristics - Electrical

		Test Cond. JIS C5101-4, Characteristic W																			
Operating Temp. Range	-40°C ~ +105°C	—																			
Rated Voltage	DC 6.3 ~ 450V	105°C																			
Capacitance	0.1 ~ 4700µF	105°C																			
Capacitance Tolerance	±20%	120Hz, 20°C																			
Leakage Current	Rated Voltage	≤100V								>100V								C = rated capacitance (µF) V = rated DC working voltage (V) Temperature = 20°C			
	Time	after 2 minutes				after 5 minutes															
	Leakage Current	I = 0.02CV or 3 (µA) whichever is greater				CV ≤1000 I = 0.03CV + 15 (µA)				CV >1000 I = 0.02CV + 25 (µA)											
Dissipation Factor (Tanδ)	Rated Voltage	6.3	10	16	25	35	50	63	100	160	200	250	350	400	450	120Hz, 20°C					
	Tanδ max	0.23	0.20	0.17	0.15	0.12	0.10	0.09	0.08	0.12	0.14	0.17	0.20	0.25	0.25						
Low Temperature Characteristics	Rated Voltage	6.3	10	16	25	35	50	63	100	160	200	250	350	400	450	120Hz					
	Impedance Ratio																				
	Z(-25°C) / øD<16	6	4	3	3	2	2	2	2	3			6	8	12			14	16		
	Z(+20°C) / øD≥16	8	6	4	4	3	3	3	3	4			8	10	—			—	—		
	Z(-40°C) / øD<16	10	8	6	6	4	3	3	3	4			8	10	—			—	—		
Z(+20°C) / øD≥16	18	16	12	10	8	8	6	6	4			8	10	—	—	—					
Load Life Test	Test Time	1000 Hrs																			
	Capacitance Change	Within ±20% of initial value																			
	Dissipation Factor	Less than 200% of specified value																			
	Leakage Current	Within specified value																			
Shelf Life Test	Test Time	1000 hrs																			
	Capacitance Change	Within ±20% of initial value																			
	Dissipation Factor	Less than 200% of specified value																			
	Leakage Current	6.3 ~ 100V - Within specified value 60 ~ 450V - Less than 200% of specified value																			
Ripple Current & Multipliers Frequency	Frequency (Hz)	60(50)				120				500				1k				≥10k			
	C (µF) < 100	0.70				1.00				1.30				1.40				1.50			
	C (µF) ≥ 100	0.75				1.00				1.20				1.30				1.35			
		—																			

Product Availability Chart

Capacitance		Rated Voltage (V.DC)													
		6.3	10	16	25	35	50	63	100	160	200	250	350	400	450
µF	Code	Dia x L	Dia x L	Dia x L	Dia x L	Dia x L	Dia x L	Dia x L	Dia x L	Dia x L	Dia x L	Dia x L	Dia x L	Dia x L	Dia x L
0.1	104						5x12	5x12	5x12						
0.22	224						5x12	5x12	5x12						
0.33	334						5x12	5x12	5x12						
0.47	474						5x12	5x12	5x12						
1.0	105						5x12	5x12	5x12	6.3x13	6.3x13	6.3x13	8x16	8x16	8x16
2.2	225						5x12	5x12	5x12	6.3x13	8x13	8x16	8x21	10x17	10x21
3.3	335						5x12	5x12	5x12	8x16	8x16	8x21	8x21	10x17	10x21
4.7	475						5x12	5x12	6.3x13	8x16	10x17	10x17	10x21	10x26	10x26
10	106			5x12	5x12	5x12	5x12	6.3x13	6.3x13	10x17	10x21	10x21	13x22	13x22	13x27
22	226			5x12	5x12	6.3x13	6.3x13	6.3x13	8x16	10x21	13x22	13x27	13x27	16x33	16x36
33	336		5x12	5x12	5x12	6.3x13	6.3x13	8x13	10x17	13x22	13x27	16x28	16x33	16x42	16x42
47	476		5x12	6.3x13	6.3x13	6.3x13	8x13	8x16	10x21	13x27	16x33	16x33	16x42	18x42	18x42
100	107	6.3x13	6.3x13	6.3x13	8x13	8x16	10x17	10x17	13x22	16x33	16x36	16x42	22x43	25x43	25x52
220	227	6.3x13	8x13	8x13	8x16	10x17	10x21	13x22	16x28	18x42	22x43	22x43			
330	337	8x16	8x16	8x16	10x17	10x21	13x22	13x22	16x33	22x43					
470	477	8x16	8x16	10x17	10x21	13x22	13x22	13x27	16x36						
1000	108	10x17	10x17	10x21	13x22	13x27	16x33	16x36	18x42						
2200	228	13x22	13x22	13x24	16x28	16x33	18x36	22x43	25x52						
3300	338	13x22	13x27	16x28	16x33	18x36	22x43	25x52							
4700	478	13x27	16x28	16x33	18x36	22x43	25x43	25x52							

Dimensions

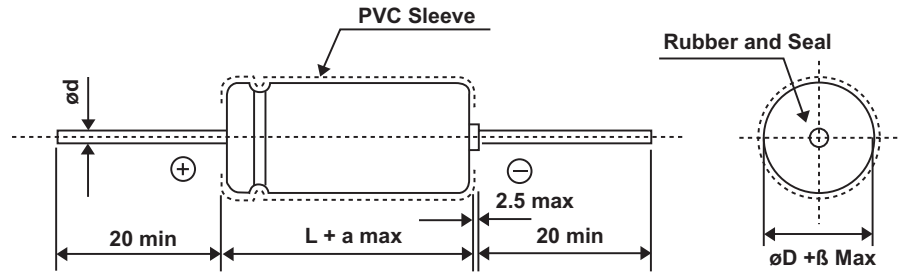

Case Code	Dimensions (mm)		
	Dia + β max	L + a max	Lead dia +0.1max
A12	5.0 +0.5	12 +1.5	0.6
B13	6.3 +0.5	13 +1.5	0.6
C13	8.0 +0.5	13 +1.5	0.6
C16	8.0 +0.5	16 +1.5	0.6
C21	8.0 +0.5	21 +1.5	0.6
D17	10 +1.0	17 +2.0	0.6
D21	10 +1.0	21 +2.0	0.6
D26	10 +1.0	26 +2.0	0.6
E22	13 +1.0	22 +2.0	0.6
E24	13 +1.0	24 +2.0	0.6
E27	13 +1.0	27 +2.0	0.6
F28	16 +1.0	28 +2.0	0.8
F33	16 +1.0	33 +2.0	0.8
F36	16 +1.0	36 +2.0	0.8
F42	16 +1.0	42 +2.0	0.8
G36	18 +1.0	36 +2.0	0.8
G42	18 +1.0	42 +2.0	0.8
H43	22 +1.0	43 +2.0	0.8
J43	25 +1.0	43 +2.0	0.8
J52	25 +1.0	52 +2.0	0.8

How to Order

TYAH	0J	107	B13	M	L
Common Part	Voltage Code	Capacitance	Case Code	Tolerance	Packaging
TYAH	0J (6.3V) 1A (10V) 1C (16V) 1E (25V) 1V (35V) 1H (50V) 1J (63V) 2A (100V) 2C (160V) 2D (200V) 2E (250V) 2V (350V) 2G (400V) 2W (450V)	e.g. 107	e.g. B13	M (20%)	L = Loose (bulk)

Snap-In Aluminium Electrolytic Capacitors – Product Overview

The TYS Series Snap-In Aluminium Electrolytic capacitors are designed for use throughout many industries in a broad range of direct-soldering, through-hole PCB applications where high power handling is essential, but board space is at a premium.

The TYSV range is suitable for general purpose and industrial filtering, bypassing, power supply, telecom and audio-video applications, the TYSH range is a high temperature version, up to 105 degrees Celsius, for use in more demanding situations.

- Snap-In mounting for high density PCB population
- Wide operating voltage range
- Broad range of capacitance values
- Extensive range of case sizes
- RoHS compliant

Voltage Range	Capacitance Range	Temperature Range	Load Life	Series	Page
16 to 500V	56 to 22000µF	-40 to +85°C	2000 hrs	TYSV	92
16 to 450V	56 to 22000µF	-40 to +105°C	2000 hrs	TYSH	103

Type TYSV Series



Tyco Electronics snap-in aluminum electrolytic capacitors are designed for direct-soldering PCB mounting where board space is restricted.

The TYSV series offers a wide capacitance range at voltages from 16 to 500Vd.c. plus a broad range of case sizes.

Suitable for general purpose and industrial filtering, bypassing, power supply coupling/decoupling, telecommunications and audio-video applications.

Key Features

- General purpose polarized aluminum foil electrolytic capacitors
- Snap-in PCB mounting
- Aluminum case with insulating sleeve
- 85°C temperature rating
- 2000 hours load life assured
- RoHS Compliant

Standard Product Table

Rated Voltage V.DC	Capacitance		Case Size Dia x L	Case Code	Dissipation Factor (%)*	Ripple Current (mA)*	Part Number
	µF	Code					
16	8200	828	22x25	H25	40	2.56	TYSV1C828H25ML
16	10000	109	22x30	H30	40	2.81	TYSV1C109H30ML
16	10000	109	25x30	J30	40	3.03	TYSV1C109J30ML
16	12000	129	22x30	H30	40	3.13	TYSV1C129H30ML
16	12000	129	25x25	J25	40	2.96	TYSV1C129J25ML
16	15000	159	22x35	H35	40	3.69	TYSV1C159H35ML
16	15000	159	25x30	J30	40	3.64	TYSV1C159J30ML
16	15000	159	30x25	K25	40	3.73	TYSV1C159K25ML
16	18000	189	22x40	H40	40	3.98	TYSV1C189H40ML
16	18000	189	25x35	J35	40	3.98	TYSV1C189J35ML
16	22000	229	22x50	H50	40	4.52	TYSV1C229H50ML
16	22000	229	25x40	J40	40	4.44	TYSV1C229J40ML
16	22000	229	30x30	K30	40	4.38	TYSV1C229K30ML
25	5600	568	22x25	H25	30	2.31	TYSV1E568H25ML
25	6800	688	22x30	H30	30	2.56	TYSV1E688H30ML
25	6800	688	25x25	J25	30	2.78	TYSV1E688J25ML
25	8200	828	22x35	H35	30	2.81	TYSV1E828H35ML
25	8200	828	25x25	J25	30	2.78	TYSV1E828J25ML
25	10000	109	22x35	H35	30	3.18	TYSV1E109H35ML
25	10000	109	25x30	J30	30	3.16	TYSV1E109J30ML
25	10000	109	30x25	K25	30	3.21	TYSV1E109K25ML
25	12000	129	22x40	H40	30	3.53	TYSV1E129H40ML
25	12000	129	25x35	J35	30	3.48	TYSV1E129J35ML
25	12000	129	30x30	K30	30	3.86	TYSV1E129K30ML
25	15000	159	22x50	H50	30	4.08	TYSV1E159H50ML
25	15000	159	25x40	J40	30	4.00	TYSV1E159J40ML
25	15000	159	30x35	K35	30	4.12	TYSV1E159K35ML
25	18000	189	25x45	J45	30	4.68	TYSV1E189J45ML
25	18000	189	30x35	K35	30	4.66	TYSV1E189K35ML
25	18000	189	35x30	L30	30	4.68	TYSV1E189L30ML
25	22000	229	30x45	K45	30	5.26	TYSV1E229K45ML
25	22000	229	35x35	L35	30	5.20	TYSV1E229L35ML
35	4700	478	22x30	H30	25	2.41	TYSV1V478H30ML
35	4700	478	25x25	J25	25	2.42	TYSV1V478J25ML
35	5600	568	22x35	H35	25	2.79	TYSV1V568H35ML
35	6800	688	22x40	H40	25	2.89	TYSV1V688H40ML
35	6800	688	25x30	J30	25	2.89	TYSV1V688J30ML
35	6800	688	30x25	K25	25	3.09	TYSV1V688K25ML
35	8200	828	22x45	H45	25	3.47	TYSV1V828H45ML
35	8200	828	25x35	J35	25	3.33	TYSV1V828J35ML
35	8200	828	30x30	K30	25	3.29	TYSV1V828K30ML
35	10000	109	22x50	H50	25	3.59	TYSV1V109H50ML
35	10000	109	25x40	J40	25	3.59	TYSV1V109J40ML
35	10000	109	30x30	K30	25	3.61	TYSV1V109K30ML
35	10000	109	35x25	L25	25	3.32	TYSV1V109L25ML
35	12000	129	25x45	J45	25	4.01	TYSV1V129J45ML
35	12000	129	30x35	K35	25	4.01	TYSV1V129K35ML
35	12000	129	35x30	L30	25	4.02	TYSV1V129L30ML
35	15000	159	30x40	K40	25	4.80	TYSV1V159K40ML
35	15000	159	35x35	L35	25	5.01	TYSV1V159L35ML
35	18000	189	30x45	K45	25	5.18	TYSV1V189K45ML

* DF measured at 120Hz, 20°C

* RC measured at 120Hz, 85°C

Standard Product Table (continued)

Rated Voltage V.DC	Capacitance		Case Size Dia x L	Case Code	Dissipation Factor (%) [*]	Ripple Current (mA) [*]	Part Number
	µF	Code					
35	18000	189	35x40	L40	25	5.71	TYSV1V189L40ML
35	22000	229	35x45	L45	25	6.38	TYSV1V229L45ML
50	2200	228	22x25	H25	20	1.93	TYSV1H228H25ML
50	2700	278	22x30	H30	20	2.21	TYSV1H278H30ML
50	3300	338	22x30	H30	20	2.41	TYSV1H338H30ML
50	3300	338	25x25	J25	20	2.38	TYSV1H338J25ML
50	3900	398	22x35	H35	20	2.72	TYSV1H398H35ML
50	3900	398	25x30	J30	20	2.68	TYSV1H398J30ML
50	4700	478	22x40	H40	20	3.01	TYSV1H478H40ML
50	4700	478	25x30	J30	20	3.03	TYSV1H478J30ML
50	4700	478	30x25	K25	20	3.01	TYSV1H478K25ML
50	5600	568	22x45	H45	20	3.43	TYSV1H568H45ML
50	5600	568	25x35	J35	20	3.37	TYSV1H568J35ML
50	5600	568	30x30	K30	20	3.43	TYSV1H568K30ML
50	6800	688	22x50	H50	20	3.94	TYSV1H688H50ML
50	6800	688	25x40	J40	20	3.87	TYSV1H688J40ML
50	6800	688	30x35	K35	20	3.87	TYSV1H688K35ML
50	8200	828	25x45	J45	20	4.37	TYSV1H828J45ML
50	8200	828	30x35	K35	20	4.42	TYSV1H828K35ML
50	8200	828	35x30	L30	20	4.41	TYSV1H828L30ML
50	10000	109	30x40	K40	20	5.02	TYSV1H109K40ML
50	10000	109	35x35	L35	20	4.92	TYSV1H109L35ML
50	12000	129	30x50	K50	20	5.60	TYSV1H129K50ML
50	12000	129	35x40	L40	20	5.60	TYSV1H129L40ML
50	15000	159	35x45	L45	20	6.44	TYSV1H159L45ML
63	1800	188	22x25	H25	15	1.90	TYSV1J188H25ML
63	2200	228	22x30	H30	15	2.35	TYSV1J228H30ML
63	2200	228	25x25	J25	15	2.30	TYSV1J228J25ML
63	2700	278	22x35	H35	15	2.50	TYSV1J278H35ML
63	2700	278	25x30	J30	15	2.52	TYSV1J278J30ML
63	3300	338	22x35	H35	15	2.62	TYSV1J338H35ML
63	3300	338	25x30	J30	15	2.69	TYSV1J338J30ML
63	3300	338	30x25	K25	15	2.78	TYSV1J338K25ML
63	3900	398	22x45	H45	15	3.10	TYSV1J398H45ML
63	3900	398	25x35	J35	15	3.09	TYSV1J398J35ML
63	3900	398	30x30	K30	15	3.09	TYSV1J398K30ML
63	4700	478	22x50	H50	15	3.49	TYSV1J478H50ML
63	4700	478	25x40	J40	15	3.37	TYSV1J478J40ML
63	4700	478	30x30	K30	15	3.37	TYSV1J478K30ML
63	4700	478	35x25	L25	15	3.36	TYSV1J478L25ML
63	5600	568	25x45	J45	15	3.77	TYSV1J568J45ML
63	5600	568	30x35	K35	15	3.75	TYSV1J568K35ML
63	6800	688	25x50	J50	15	4.41	TYSV1J688J50ML
63	6800	688	30x40	K40	15	4.41	TYSV1J688K40ML
63	6800	688	35x35	L35	15	4.33	TYSV1J688L35ML
63	8200	828	30x45	K45	15	4.90	TYSV1J828K45ML
63	8200	828	35x35	L35	15	4.80	TYSV1J828L35ML
63	10000	109	30x50	K50	15	5.49	TYSV1J109K50ML
63	10000	109	35x40	L40	15	5.47	TYSV1J109L40ML
63	12000	129	35x50	L50	15	6.30	TYSV1J129L50ML

* DF measured at 120Hz, 20°C

* RC measured at 120Hz, 85°C

Standard Product Table (continued)

Rated Voltage V.DC	Capacitance		Case Size Dia x L	Case Code	Dissipation Factor (%) [*]	Ripple Current (mA) [*]	Part Number
	µF	Code					
100	1200	128	22x30	H30	15	2.12	TYSV2A128H30ML
100	1200	128	25x25	J25	15	2.10	TYSV2A128J25ML
100	1500	158	22x35	H35	15	2.45	TYSV2A158H35ML
100	1500	158	25x30	J30	15	2.43	TYSV2A158J30ML
100	1500	158	30x25	K25	15	2.46	TYSV2A158K25ML
100	1800	188	22x40	H40	15	2.77	TYSV2A188H40ML
100	1800	188	25x35	J35	15	2.77	TYSV2A188J35ML
100	1800	188	30x25	K25	15	2.65	TYSV2A188K25ML
100	2200	228	22x45	H45	15	3.12	TYSV2A228H45ML
100	2200	228	25x40	J40	15	3.20	TYSV2A228J40ML
100	2200	228	30x30	K30	15	3.10	TYSV2A228K30ML
100	2200	228	35x25	L25	15	3.14	TYSV2A228L25ML
100	2700	278	25x45	J45	15	3.61	TYSV2A278J45ML
100	2700	278	30x35	K35	15	3.60	TYSV2A278K35ML
100	2700	278	35x30	L30	15	3.71	TYSV2A278L30ML
100	3300	338	25x50	J50	15	4.06	TYSV2A338J50ML
100	3300	338	30x40	K40	15	4.05	TYSV2A338K40ML
100	3300	338	35x35	L35	15	4.07	TYSV2A338L35ML
100	3900	398	30x45	K45	15	4.60	TYSV2A398K45ML
100	3900	398	35x35	L35	15	4.50	TYSV2A398L35ML
100	4700	478	30x50	K50	15	5.13	TYSV2A478K50ML
100	4700	478	35x40	L40	15	5.12	TYSV2A478L40ML
100	5600	568	35x45	L45	15	5.75	TYSV2A568L45ML
100	6800	688	35x50	L50	15	6.01	TYSV2A688L50ML
160	270	277	22x25	H25	15	1.27	TYSV2C277H25ML
160	330	337	22x25	H25	15	1.40	TYSV2C337H25ML
160	390	397	22x30	H30	15	1.62	TYSV2C397H30ML
160	470	477	22x30	H30	15	1.77	TYSV2C477H30ML
160	470	477	25x25	J25	15	1.77	TYSV2C477J25ML
160	560	567	22x30	H30	15	1.92	TYSV2C567H30ML
160	560	567	22x35	H35	15	2.05	TYSV2C567H35ML
160	560	567	25x25	J25	15	1.92	TYSV2C567J25ML
160	560	567	25x30	J30	15	2.05	TYSV2C567J30ML
160	680	687	22x35	H35	15	2.12	TYSV2C687H35ML
160	680	687	22x40	H40	15	2.24	TYSV2C687H40ML
160	680	687	25x30	J30	15	2.22	TYSV2C687J30ML
160	680	687	30x25	K25	15	2.22	TYSV2C687K25ML
160	820	827	22x40	H40	15	2.32	TYSV2C827H40ML
160	820	827	22x45	H45	15	2.55	TYSV2C827H45ML
160	820	827	25x30	J30	15	2.32	TYSV2C827J30ML
160	820	827	25x35	J35	15	2.52	TYSV2C827J35ML
160	820	827	30x25	K25	15	2.31	TYSV2C827K25ML
160	820	827	30x30	K30	15	2.51	TYSV2C827K30ML
160	1000	108	22x50	H50	15	2.88	TYSV2C108H50ML
160	1000	108	25x40	J40	15	2.86	TYSV2C108J40ML
160	1000	108	25x45	J45	15	2.98	TYSV2C108J45ML
160	1000	108	30x30	K30	15	2.82	TYSV2C108K30ML
160	1000	108	30x35	K35	15	2.94	TYSV2C108K35ML
160	1000	108	35x30	L30	15	2.92	TYSV2C108L30ML
160	1200	128	25x45	J45	15	3.27	TYSV2C128J45ML

* DF measured at 120Hz, 20°C

* RC measured at 120Hz, 85°C

Standard Product Table (continued)

Rated Voltage V.DC	Capacitance		Case Size Dia x L	Case Code	Dissipation Factor (%)*	Ripple Current (mA)*	Part Number
	µF	Code					
160	1200	128	25x50	J50	15	3.43	TYSV2C128J50ML
160	1200	128	30x35	K35	15	3.25	TYSV2C128K35ML
160	1200	128	35x30	L30	15	3.24	TYSV2C128L30ML
160	1500	158	30x40	K40	15	3.77	TYSV2C158K40ML
160	1500	158	30x45	K45	15	3.92	TYSV2C158K45ML
160	1500	158	35x35	L35	15	3.75	TYSV2C158L35ML
160	1800	188	30x45	K45	15	4.10	TYSV2C188K45ML
160	1800	188	30x50	K50	15	4.32	TYSV2C188K50ML
160	1800	188	35x35	L35	15	4.08	TYSV2C188L35ML
160	2200	228	35x45	L45	15	4.72	TYSV2C228L45ML
200	150	157	22x25	H25	15	0.95	TYSV2D157H25ML
200	220	227	22x25	H25	15	1.15	TYSV2D227H25ML
200	270	277	22x25	H25	15	1.30	TYSV2D277H25ML
200	330	337	22x30	H30	15	1.44	TYSV2D337H30ML
200	330	337	25x25	J25	15	1.43	TYSV2D337J25ML
200	390	397	22x30	H30	15	1.65	TYSV2D397H30ML
200	390	397	25x25	J25	15	1.63	TYSV2D397J25ML
200	470	477	22x35	H35	15	1.88	TYSV2D477H35ML
200	470	477	25x30	J30	15	1.86	TYSV2D477J30ML
200	470	477	30x25	K25	15	1.85	TYSV2D477K25ML
200	560	567	22x40	H40	15	2.08	TYSV2D567H40ML
200	560	567	25x30	J30	15	2.05	TYSV2D567J30ML
200	560	567	30x25	K25	15	2.05	TYSV2D567K25ML
200	680	687	22x45	H45	15	2.36	TYSV2D687H45ML
200	680	687	25x35	J35	15	2.36	TYSV2D687J35ML
200	680	687	30x30	K30	15	2.36	TYSV2D687K30ML
200	820	827	22x50	H50	15	2.68	TYSV2D827H50ML
200	820	827	25x40	J40	15	2.66	TYSV2D827J40ML
200	820	827	25x45	J45	15	2.79	TYSV2D827J45ML
200	820	827	30x30	K30	15	2.62	TYSV2D827K30ML
200	820	827	30x35	K35	15	2.77	TYSV2D827K35ML
200	820	827	35x30	L30	15	2.72	TYSV2D827L30ML
200	1000	108	25x45	J45	15	3.12	TYSV2D108J45ML
200	1000	108	25x50	J50	15	2.96	TYSV2D108J50ML
200	1000	108	30x35	K35	15	3.00	TYSV2D108K35ML
200	1000	108	30x40	K40	15	3.10	TYSV2D108K40ML
200	1000	108	35x30	L30	15	2.96	TYSV2D108L30ML
200	1200	128	30x40	K40	15	3.44	TYSV2D128K40ML
200	1200	128	30x45	K45	15	3.53	TYSV2D128K45ML
200	1200	128	35x35	L35	15	3.40	TYSV2D128L35ML
200	1500	158	30x50	K50	15	3.93	TYSV2D158K50ML
200	1500	158	35x40	L40	15	3.87	TYSV2D158L40ML
200	1800	188	35x45	L45	15	4.37	TYSV2D188L45ML
200	2200	228	35x50	L50	15	5.00	TYSV2D228L50ML
250	150	157	22x25	H25	15	0.91	TYSV2E157H25ML
250	180	187	22x25	H25	15	1.01	TYSV2E187H25ML
250	220	227	22x25	H25	15	1.18	TYSV2E227H25ML
250	220	227	25x25	J25	15	1.24	TYSV2E227J25ML
250	270	277	22x30	H30	15	1.43	TYSV2E277H30ML
250	270	277	25x25	J25	15	1.49	TYSV2E277J25ML

* DF measured at 120Hz, 20°C

* RC measured at 120Hz, 85°C

Standard Product Table (continued)

Rated Voltage V.DC	Capacitance		Case Size Dia x L	Case Code	Dissipation Factor (%)*	Ripple Current (mA)*	Part Number
	µF	Code					
250	330	337	22x30	H30	15	1.58	TYSV2E337H30ML
250	330	337	22x35	H35	15	1.67	TYSV2E337H35ML
250	330	337	25x25	J25	15	1.53	TYSV2E337J25ML
250	330	337	25x30	J30	15	1.62	TYSV2E337J30ML
250	390	397	22x35	H35	15	1.79	TYSV2E397H35ML
250	390	397	22x40	H40	15	1.89	TYSV2E397H40ML
250	390	397	25x30	J30	15	1.79	TYSV2E397J30ML
250	390	397	25x35	J35	15	1.87	TYSV2E397J35ML
250	390	397	30x25	K25	15	1.77	TYSV2E397K25ML
250	470	477	22x40	H40	15	2.05	TYSV2E477H40ML
250	470	477	22x45	H45	15	2.14	TYSV2E477H45ML
250	470	477	25x35	J35	15	2.05	TYSV2E477J35ML
250	470	477	30x30	K30	15	2.03	TYSV2E477K30ML
250	560	567	22x50	H50	15	2.43	TYSV2E567H50ML
250	560	567	25x40	J40	15	2.32	TYSV2E567J40ML
250	560	567	25x45	J45	15	2.41	TYSV2E567J45ML
250	560	567	30x30	K30	15	2.24	TYSV2E567K30ML
250	560	567	30x35	K35	15	2.32	TYSV2E567K35ML
250	560	567	35x25	L25	15	2.21	TYSV2E567L25ML
250	680	687	25x45	J45	15	2.62	TYSV2E687J45ML
250	680	687	25x50	J50	15	2.70	TYSV2E687J50ML
250	680	687	30x35	K35	15	2.58	TYSV2E687K35ML
250	680	687	30x40	K40	15	2.65	TYSV2E687K40ML
250	680	687	35x30	L30	15	2.54	TYSV2E687L30ML
250	820	827	30x40	K40	15	2.92	TYSV2E827K40ML
250	820	827	30x45	K45	15	3.00	TYSV2E827K45ML
250	820	827	35x35	L35	15	2.90	TYSV2E827L35ML
250	1000	108	30x50	K50	15	3.47	TYSV2E108K50ML
250	1000	108	35x40	L40	15	3.39	TYSV2E108L40ML
250	1200	128	35x45	L45	15	3.74	TYSV2E128L45ML
350	82	826	22x25	H25	20	0.81	TYSV2V826H25ML
350	100	107	22x25	H25	20	0.90	TYSV2V107H25ML
350	120	127	22x25	H25	20	0.99	TYSV2V127H25ML
350	120	127	22x30	H30	20	1.05	TYSV2V127H30ML
350	120	127	25x25	J25	20	1.04	TYSV2V127J25ML
350	150	157	22x30	H30	20	1.14	TYSV2V157H30ML
350	150	157	22x35	H35	20	1.24	TYSV2V157H35ML
350	150	157	25x25	J25	20	1.16	TYSV2V157J25ML
350	150	157	25x30	J30	20	1.24	TYSV2V157J30ML
350	150	157	30x25	K25	20	1.24	TYSV2V157K25ML
350	180	187	22x40	H40	20	1.38	TYSV2V187H40ML
350	180	187	25x30	J30	20	1.30	TYSV2V187J30ML
350	180	187	25x35	J35	20	1.37	TYSV2V187J35ML
350	180	187	30x25	K25	20	1.37	TYSV2V187K25ML
350	220	227	22x40	H40	20	1.40	TYSV2V227H40ML
350	220	227	22x45	H45	20	1.49	TYSV2V227H45ML
350	220	227	25x35	J35	20	1.46	TYSV2V227J35ML
350	220	227	25x40	J40	20	1.51	TYSV2V227J40ML
350	220	227	30x25	K25	20	1.47	TYSV2V227K25ML
350	220	227	30x30	K30	20	1.52	TYSV2V227K30ML

* DF measured at 120Hz, 20°C

* RC measured at 120Hz, 85°C

Standard Product Table (continued)

Rated Voltage V.DC	Capacitance		Case Size Dia x L	Case Code	Dissipation Factor (%) [*]	Ripple Current (mA) [*]	Part Number
	µF	Code					
350	270	277	22x45	H45	20	1.62	TYSV2V277H45ML
350	270	277	25x35	J35	20	1.65	TYSV2V277J35ML
350	270	277	25x40	J40	20	1.73	TYSV2V277J40ML
350	270	277	30x30	K30	20	1.71	TYSV2V277K30ML
350	270	277	30x35	K35	20	1.76	TYSV2V277K35ML
350	270	277	35x25	L25	20	1.72	TYSV2V277L25ML
350	330	337	22x50	H50	20	1.94	TYSV2V337H50ML
350	330	337	25x40	J40	20	1.88	TYSV2V337J40ML
350	330	337	25x45	J45	20	1.96	TYSV2V337J45ML
350	330	337	30x35	K35	20	1.93	TYSV2V337K35ML
350	330	337	30x40	K40	20	1.98	TYSV2V337K40ML
350	330	337	35x30	L30	20	1.96	TYSV2V337L30ML
350	390	397	25x45	J45	20	2.04	TYSV2V397J45ML
350	390	397	30x35	K35	20	2.12	TYSV2V397K35ML
350	390	397	30x40	K40	20	2.18	TYSV2V397K40ML
350	390	397	35x30	L30	20	2.19	TYSV2V397L30ML
350	390	397	35x35	L35	20	2.24	TYSV2V397L35ML
350	470	477	30x40	K40	20	2.41	TYSV2V477K40ML
350	470	477	30x45	K45	20	2.48	TYSV2V477K45ML
350	470	477	35x35	L35	20	2.43	TYSV2V477L35ML
350	470	477	35x40	L40	20	2.50	TYSV2V477L40ML
350	560	567	30x45	K45	20	2.60	TYSV2V567K45ML
350	560	567	35x35	L35	20	2.62	TYSV2V567L35ML
350	560	567	35x40	L40	20	2.69	TYSV2V567L40ML
350	680	687	35x45	L45	20	3.08	TYSV2V687L45ML
400	68	686	22x25	H25	20	0.72	TYSV2G686H25ML
400	82	826	22x25	H25	20	0.80	TYSV2G826H25ML
400	100	107	22x30	H30	20	0.94	TYSV2G107H30ML
400	100	107	25x25	J25	20	0.97	TYSV2G107J25ML
400	120	127	22x30	H30	20	1.04	TYSV2G127H30ML
400	120	127	22x35	H35	20	1.12	TYSV2G127H35ML
400	120	127	25x25	J25	20	1.08	TYSV2G127J25ML
400	150	157	22x35	H35	20	1.18	TYSV2G157H35ML
400	150	157	22x40	H40	20	1.25	TYSV2G157H40ML
400	150	157	25x30	J30	20	1.21	TYSV2G157J30ML
400	150	157	30x25	K25	20	1.24	TYSV2G157K25ML
400	180	187	22x40	H40	20	1.34	TYSV2G187H40ML
400	180	187	22x45	H45	20	1.40	TYSV2G187H45ML
400	180	187	25x35	J35	20	1.37	TYSV2G187J35ML
400	180	187	30x30	K30	20	1.52	TYSV2G187K30ML
400	220	227	22x45	H45	20	1.50	TYSV2G227H45ML
400	220	227	22x50	H50	20	1.56	TYSV2G227H50ML
400	220	227	25x35	J35	20	1.56	TYSV2G227J35ML
400	220	227	25x40	J40	20	1.62	TYSV2G227J40ML
400	220	227	30x30	K30	20	1.58	TYSV2G227K30ML
400	270	277	25x40	J40	20	1.70	TYSV2G277J40ML
400	270	277	25x45	J45	20	1.76	TYSV2G277J45ML
400	270	277	30x35	K35	20	1.73	TYSV2G277K35ML
400	270	277	35x30	L30	20	1.75	TYSV2G277L30ML
400	330	337	25x50	J50	20	1.90	TYSV2G337J50ML

* DF measured at 120Hz, 20°C

* RC measured at 120Hz, 85°C

Standard Product Table (continued)

Rated Voltage V.DC	Capacitance		Case Size Dia x L	Case Code	Dissipation Factor (%)*	Ripple Current (mA)*	Part Number
	µF	Code					
400	330	337	30x40	K40	20	1.97	TYSV2G337K40ML
400	330	337	35x30	L30	20	1.95	TYSV2G337L30ML
400	330	337	35x35	L35	20	2.02	TYSV2G337L35ML
400	390	397	30x40	K40	20	2.15	TYSV2G397K40ML
400	390	397	30x45	K45	20	2.22	TYSV2G397K45ML
400	390	397	35x35	L35	20	2.17	TYSV2G397L35ML
400	390	397	35x40	L40	20	2.24	TYSV2G397L40ML
400	470	477	30x50	K50	20	2.40	TYSV2G477K50ML
400	470	477	35x40	L40	20	2.42	TYSV2G477L40ML
400	470	477	35x45	L45	20	2.48	TYSV2G477L45ML
400	560	567	35x45	L45	20	2.71	TYSV2G567L45ML
400	560	567	35x50	L50	20	2.78	TYSV2G567L50ML
400	680	687	35x50	L50	20	2.95	TYSV2G687L50ML
450	56	566	22x25	H25	20	0.68	TYSV2W566H25ML
450	68	686	22x25	H25	20	0.72	TYSV2W686H25ML
450	82	826	22x30	H30	20	0.87	TYSV2W826H30ML
450	82	826	25x25	J25	20	0.85	TYSV2W826J25ML
450	100	107	22x35	H35	20	1.00	TYSV2W107H35ML
450	100	107	25x25	J25	20	0.98	TYSV2W107J25ML
450	120	127	22x35	H35	20	1.05	TYSV2W127H35ML
450	120	127	22x40	H40	20	1.15	TYSV2W127H40ML
450	120	127	25x30	J30	20	1.09	TYSV2W127J30ML
450	120	127	30x25	K25	20	1.10	TYSV2W127K25ML
450	150	157	22x40	H40	20	1.20	TYSV2W157H40ML
450	150	157	25x35	J35	20	1.27	TYSV2W157J35ML
450	150	157	25x40	J40	20	1.35	TYSV2W157J40ML
450	150	157	30x30	K30	20	1.32	TYSV2W157K30ML
450	180	187	22x50	H50	20	1.51	TYSV2W187H50ML
450	180	187	25x40	J40	20	1.45	TYSV2W187J40ML
450	180	187	25x45	J45	20	1.50	TYSV2W187J45ML
450	180	187	30x30	K30	20	1.43	TYSV2W187K30ML
450	180	187	30x35	K35	20	1.49	TYSV2W187K35ML
450	180	187	35x30	L30	20	1.49	TYSV2W187L30ML
450	220	227	25x45	J45	20	1.65	TYSV2W227J45ML
450	220	227	25x50	J50	20	1.73	TYSV2W227J50ML
450	220	227	30x35	K35	20	1.63	TYSV2W227K35ML
450	220	227	30x40	K40	20	1.72	TYSV2W227K40ML
450	220	227	35x30	L30	20	1.61	TYSV2W227L30ML
450	270	277	30x40	K40	20	1.83	TYSV2W277K40ML
450	270	277	30x45	K45	20	1.95	TYSV2W277K45ML
450	270	277	35x35	L35	20	1.86	TYSV2W277L35ML
450	330	337	30x45	K45	20	2.10	TYSV2W337K45ML
450	330	337	30x50	K50	20	2.19	TYSV2W337K50ML
450	330	337	35x35	L35	20	2.06	TYSV2W337L35ML
450	330	337	35x40	L40	20	2.13	TYSV2W337L40ML
450	390	397	30x50	K50	20	2.24	TYSV2W397K50ML
450	390	397	35x45	L45	20	2.10	TYSV2W397L45ML
450	470	477	35x50	L50	20	2.63	TYSV2W477L50ML
500	56	566	22x25	H25	20	0.70	TYSV2H566H25ML
500	68	686	22x30	H30	20	0.82	TYSV2H686H30ML

* DF measured at 120Hz, 20°C

* RC measured at 120Hz, 85°C

Standard Product Table (continued)

Rated Voltage V.DC	Capacitance		Case Size Dia x L	Case Code	Dissipation Factor (%)*	Ripple Current (mA)*	Part Number
	µF	Code					
500	82	826	22x35	H35	20	0.96	TYSV2H826H35ML
500	82	826	25x30	J30	20	0.97	TYSV2H826J30ML
500	100	107	22x40	H40	20	1.14	TYSV2H107H40ML
500	100	107	25x35	J35	20	1.15	TYSV2H107J35ML
500	120	127	22x45	H45	20	1.30	TYSV2H127H45ML
500	120	127	25x35	J35	20	1.25	TYSV2H127J35ML
500	120	127	30x30	K30	20	1.26	TYSV2H127K30ML
500	150	157	25x40	J40	20	1.48	TYSV2H157J40ML
500	150	157	30x35	K35	20	1.50	TYSV2H157K35ML
500	150	157	35x30	L30	20	1.34	TYSV2H157L30ML
500	180	187	25x50	J50	20	1.65	TYSV2H187J50ML
500	180	187	30x40	K40	20	1.60	TYSV2H187K40ML
500	180	187	35x30	L30	20	1.55	TYSV2H187L30ML
500	220	227	30x45	K45	20	1.90	TYSV2H227K45ML
500	220	227	35x35	L35	20	1.85	TYSV2H227L35ML
500	270	277	35x40	L40	20	1.95	TYSV2H277L40ML
500	330	337	35x45	L45	20	2.00	TYSV2H337L45ML

* DF measured at 120Hz, 20°C

* RC measured at 120Hz, 85°C

Product Availability Chart

Capacitance		Rated Voltage (V.DC)												
		16				25				35				
µF	Code	Dia x L	Dia x L	Dia x L	Dia x L	Dia x L	Dia x L	Dia x L	Dia x L	Dia x L	Dia x L	Dia x L	Dia x L	
4700	478									22x30	25x25			
5600	568						22x25				22x35			
6800	688						22x30	25x25			22x40	25x30	30x25	
8200	828	22x25					22x35	25x25			22x45	25x35	30x30	
10000	109	22x30	25x30				22x35	25x30	30x25		22x50	25x40	30x30	35x25
12000	129	22x30	25x25				22x40	25x35	30x30			25x45	30x35	35x30
15000	159	22x35	25x30	30x25			22x50	25x40	30x35				30x40	35x35
18000	189	22x40	25x35					25x45	30x35	35x30			30x45	35x40
22000	229	22x50	25x40	30x30					30x45	35x35				35x45

Capacitance		Rated Voltage (V.DC)												
		50				63				100				
µF	Code	Dia x L	Dia x L	Dia x L	Dia x L	Dia x L	Dia x L	Dia x L	Dia x L	Dia x L	Dia x L	Dia x L	Dia x L	
1200	128										22x30	25x25		
1500	158										22x35	25x30	30x25	
1800	188						22x25				22x40	25x35	30x25	
2200	228	22x25					22x30	25x25			22x45	25x40	30x30	35x25
2700	278	22x30					22x35	25x30				25x45	30x35	35x30
3300	338	22x30	25x25				22x35	25x30	30x25			25x50	30x40	35x35
3900	398	22x35	25x30				22x45	25x35	30x30				30x45	35x35
4700	478	22x40	25x30	30x25			22x50	25x40	30x30	35x25			30x50	35x40
5600	568	22x45	25x35	30x30				25x45	30x35					35x45
6800	688	22x50	25x40	30x35				25x50	30x40	35x35				35x50
8200	828		25x45	30x35	35x30				30x45	35x35				
10000	109			30x40	35x35				30x50	35x40				
12000	129			30x50	35x40					35x50				
15000	159				35x45									

Product Availability Chart (continued)

Capacitance		Rated Voltage (V.DC)																
		160				200				250				350				
µF	Code	Dia x L	Dia x L	Dia x L	Dia x L	Dia x L	Dia x L	Dia x L	Dia x L	Dia x L	Dia x L	Dia x L	Dia x L	Dia x L	Dia x L	Dia x L	Dia x L	
82	826														22x25			
100	107														22x25			
120	127														22x25	25x25		
															22x30			
150	157					22x25				22x25					22x30	25x25	30x25	
															22x35	25x30		
180	187									22x25					22x40	25x30	30x25	
															25x35			
220	227					22x25				22x25	25x25				22x40	25x35	30x25	
															22x45	25x40	30x30	
270	277	22x25				22x25				22x30	25x25				22x45	25x35	30x30	35x25
															25x40	30x35		
330	337	22x25				22x30	25x25			22x30	25x25				22x50	25x40	30x35	35x30
										22x35	25x30				25x45	30x40		
390	397	22x30				22x30	25x25			22x35	25x30	30x25			25x45	30x35	35x30	
										22x40	25x35					30x40	35x35	
470	477	22x30	25x25			22x35	25x30	30x25		22x40	25x35	30x30				30x40	35x35	
										22x45						30x45	35x40	
560	567	22x30	25x25			22x40	25x30	30x25		22x50	25x40	30x30	35x25			30x45	35x35	
		22x35	25x30								25x45	30x35					35x40	
680	687	22x35	25x30	30x25		22x45	25x35	30x30			25x45	30x35	35x30				35x45	
		22x40									25x50	30x40						
820	827	22x40	25x30	30x25		22x50	25x40	30x30	35x30					30x40	35x35			
		22x45	25x35	30x30			25x45	30x35						30x45				
1000	108	22x50	25x40	30x30	35x30		25x45	30x35	35x30					30x50	35x40			
			25x45	30x35			25x50	30x40										
1200	128		25x45	30x35	35x30			30x40	35x35					35x45				
			25x50					30x45										
1500	158			30x40	35x35				30x50	35x40								
				30x45														
1800	188			30x45	35x35				35x45									
				30x50														
2200	228				35x45				35x50									

Capacitance		Rated Voltage (V.DC)												
		400				450				500				
µF	Code	Dia x L	Dia x L	Dia x L	Dia x L	Dia x L	Dia x L	Dia x L	Dia x L	Dia x L	Dia x L	Dia x L	Dia x L	
56	566						22 x 25					22 x 25		
68	686	22 x 25					22 x 25					22 x 30		
82	826	22 x 25					22 x 30	25 x 25				22 x 35	25 x 30	
100	107	22 x 30	25 x 25				22 x 35	25 x 25				22 x 40	25 x 35	
120	127	22 x 30	25 x 25				22 x 35	25 x 30	30 x 25			22 x 45	25 x 35	30 x 30
		22 x 35					22 x 40							
150	157	22 x 35	25 x 30	30 x 25			22 x 40	25 x 35	30 x 30			25 x 40	30 x 35	35 x 30
		22 x 40						25 x 40						
180	187	22 x 40	25 x 35	30 x 30			22 x 50	25 x 40	30 x 30	35 x 30		25 x 50	30 x 40	35 x 30
		22 x 45						25 x 45	30 x 35					
220	227	22 x 45	25 x 35	30 x 30				25 x 45	30 x 35	35 x 30			30 x 45	35 x 35
		22 x 50	25 x 40					25 x 50	30 x 40					
270	277		25 x 40	30 x 35	35 x 30				30 x 40	35 x 35				35 x 40
			25 x 45						30 x 45					
330	337		25 x 50	30 x 40	35 x 30				30 x 45	35 x 35				35 x 45
					35 x 35				30 x 50	35 x 40				
390	397			30 x 40	35 x 35				30 x 50	35 x 45				
				30 x 45	35 x 40									
470	477			30 x 50	35 x 40					35 x 50				
					35 x 45									
560	567				35 x 45									
					35 x 50									
680	687				35 x 50									

Characteristics - Electrical

																Test Conditions JIS C5101-4
Operating Temp. Range	-40°C ~ +85°C														—	
Rated Voltage	DC 16 ~ 500V														85°C	
Capacitance	56μF ~ 22000μF														85°C	
Capacitance Tolerance	±20%														120Hz, 20°C	
Leakage Current	I = 0.02CV or 1.5mA whichever is smaller (after 5 minutes)														C = rated capacitance (μF) V = rated DC working voltage (V) Temperature = 20°C	
Dissipation Factor (Tanδ)	Rated Voltage	16	25	35	50	63	100	160	200	250	350	400	450	500	120Hz, 20°C	
	Tanδ max	0.40	0.30	0.25	0.20	0.15	0.15	0.15	0.15	0.15	0.20	0.20	0.20	0.20		
Low Temperature Characteristics	Rated Voltage	16	25	35	50	63	100	160	200	250	350	400	450	500	120Hz	
	Impedance Ratio															
	Z(-25°C) / Z(+20°C)	4	3	3	2	2	2	4	4	4	4	8	8	8		
	Z(-40°C) / Z(+20°C)	15	10	8	6	6	5	4	8	10	16	18	20	20		
Load Life Test	Test Time	2000 Hrs													Specification satisfied when the capacitors are restored to 20°C after the rated voltage applied with rated ripple current for 2000 hrs at 85°C	
	Capacitance Change	Within ±20% of initial value														
	Dissipation Factor	Less than 200% of specified value														
	Leakage Current	Within specified value														
Shelf Life Test	Test Time	1000 hrs													Specifications satisfied when the capacitors are restored to 20°C after exposing them for 1000 hrs at 85°C without voltage applied. The rated voltage shall be applied to the capacitors before the measurements. Refer to JIS C 5102)	
	Capacitance Change	Within ±20% of initial value														
	Dissipation Factor	Less than 150% of specified value														
	Leakage Current	Within specified value														
Ripple Current & Frequency Multipliers	Frequency (Hz)	60			120			500			1k			≥10k		—
	VDC ≤ 100	0.92			1.00			1.13			1.19			1.20		
	VDC 160~250	0.81			1.00			1.32			1.45			1.50		
	VDC 300~500	0.77			1.00			1.30			1.41			1.43		

Dimensions

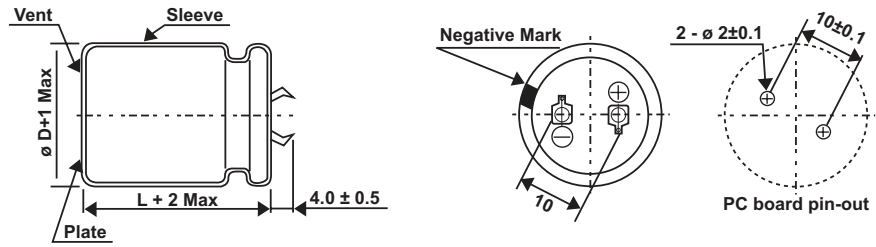

Case Code	Dimensions (mm)	
	Dia	L
H25	22	25
H30	22	30
H35	22	35
H40	22	40
H45	22	45
H50	22	50
J25	25	25
J30	25	30
J35	25	35
J40	25	40
J45	25	45
J50	25	50
K25	30	25
K30	30	30
K35	30	35
K40	30	40
K45	30	45
K50	30	50
L25	35	25
L30	35	30
L35	35	35
L40	35	40
L45	35	45
L50	35	50

How to Order

TYSV	1C	828	H25	M	L
Common Part	Voltage Code	Capacitance	Case Code	Tolerance	Packaging
TYSV	1C (16V) 1E (25V) 1V (35V) 1H (50V) 1J (63V) 2A (100V) 2C (160V) 2D (200V) 2E (250V) 2V (350V) 2G (400V) 2W (450V) 2H (500V)	e.g. 828	e.g. H25	M (20%)	L = Loose (bulk)

Type TYSH 105°C Series

Type TYSH Series



Tyco Electronics snap-in aluminum electrolytic capacitors are designed for direct-soldering PCB mounting where board space is restricted.

The TYSH series offers an extended temperature range from -40°C to +105°C, with a wide capacitance range at voltages from 16 to 450Vd.c. plus a broad range of case sizes.

Suitable for general purpose and industrial filtering, bypassing, power supply coupling/decoupling, telecommunications and audio-video applications requiring reliability under more demanding conditions.

Key Features

- High temperature polarized aluminum foil electrolytic capacitors
- Snap-in PCB mounting
- Aluminum case with insulating sleeve
- 105°C temperature rating
- 2000 hours load life assured
- RoHS Compliant

Standard Product Table

Rated Voltage V.DC	Capacitance		Case Size Dia x L	Case Code	Dissipation Factor (%)*	Ripple Current (mA)*	Part Number
	µF	Code					
16	6800	688	22x25	H25	40	1.57	TYSH1C688H25ML
16	8200	828	22x25	H25	40	1.94	TYSH1C828H25ML
16	10000	109	22x30	H30	40	1.97	TYSH1C109H30ML
16	10000	109	25x30	J30	40	2.12	TYSH1C109J30ML
16	12000	129	22x35	H35	40	2.22	TYSH1C129H35ML
16	12000	129	25x30	J30	40	2.24	TYSH1C129J30ML
16	12000	129	30x25	K25	40	2.45	TYSH1C129K25ML
16	15000	159	22x40	H40	40	2.55	TYSH1C159H40ML
16	15000	159	25x35	J35	40	2.58	TYSH1C159J35ML
16	18000	189	22x45	H45	40	2.87	TYSH1C189H45ML
16	18000	189	25x40	J40	40	2.92	TYSH1C189J40ML
16	18000	189	30x30	K30	40	2.88	TYSH1C189K30ML
16	18000	189	35x25	L25	40	2.92	TYSH1C189L25ML
16	22000	229	25x45	J45	40	3.32	TYSH1C229J45ML
16	22000	229	30x35	K35	40	2.29	TYSH1C229K35ML
25	4700	478	22x25	H25	30	1.50	TYSH1E478H25ML
25	5600	568	22x25	H25	30	1.72	TYSH1E568H25ML
25	6800	688	22x30	H30	30	1.86	TYSH1E688H30ML
25	6800	688	25x25	J25	30	1.87	TYSH1E688J25ML
25	8200	828	22x35	H35	30	2.11	TYSH1E828H35ML
25	8200	828	25x30	J30	30	2.12	TYSH1E828J30ML
25	8200	828	30x25	K25	30	2.15	TYSH1E828K25ML
25	10000	109	22x40	H40	30	2.39	TYSH1E109H40ML
25	10000	109	25x35	J35	30	2.42	TYSH1E109J35ML
25	12000	129	22x45	H45	30	2.69	TYSH1E129H45ML
25	12000	129	25x40	J40	30	2.74	TYSH1E129J40ML
25	12000	129	30x30	K30	30	2.70	TYSH1E129K30ML
25	12000	129	35x25	L25	30	2.74	TYSH1E129L25ML
25	15000	159	25x45	J45	30	3.15	TYSH1E159J45ML
25	15000	159	30x35	K35	30	3.13	TYSH1E159K35ML
25	15000	159	35x30	L30	30	3.27	TYSH1E159L30ML
25	18000	189	25x50	J50	30	3.54	TYSH1E189J50ML
25	18000	189	30x40	K40	30	3.54	TYSH1E189K40ML
25	22000	229	30x45	K45	30	4.04	TYSH1E229K45ML
25	22000	229	35x35	L35	30	3.64	TYSH1E229L35ML
35	4700	478	25x25	J25	25	1.80	TYSH1V478J25ML
35	5600	568	22x35	H35	25	1.95	TYSH1V568H35ML
35	5600	568	25x30	J30	25	1.96	TYSH1V568J30ML
35	5600	568	30x25	K25	25	1.99	TYSH1V568K25ML
35	6800	688	22x40	H40	25	2.20	TYSH1V688H40ML
35	6800	688	25x35	J35	25	2.23	TYSH1V688J35ML
35	8200	828	22x50	H50	25	2.55	TYSH1V828H50ML
35	8200	828	25x40	J40	25	2.53	TYSH1V828J40ML
35	8200	828	30x30	K30	25	2.75	TYSH1V828K30ML
35	8200	828	35x25	L25	25	2.75	TYSH1V828L25ML
35	10000	109	25x45	J45	25	2.87	TYSH1V109J45ML
35	10000	109	30x35	K35	25	2.90	TYSH1V109K35ML
35	12000	129	25x50	J50	25	3.24	TYSH1V129J50ML
35	12000	129	30x40	K40	25	3.23	TYSH1V129K40ML
35	12000	129	35x30	L30	25	2.99	TYSH1V129L30ML
35	15000	159	30x45	K45	25	3.72	TYSH1V159K45ML

*DF measured at 120Hz, 20°C

*RC measured at 120Hz, 105°C

Standard Product Table (continued)

Rated Voltage V.DC	Capacitance		Case Size Dia x L	Case Code	Dissipation Factor (%) [*]	Ripple Current (mA) [*]	Part Number
	µF	Code					
35	15000	159	35x35	L35	25	3.67	TYSH1V159L35ML
35	18000	189	35x40	L40	25	4.37	TYSH1V189L40ML
35	22000	229	35x50	L50	25	4.92	TYSH1V229L50ML
50	1800	188	22x25	H25	20	1.33	TYSH1H188H25ML
50	2200	228	22x25	H25	20	1.48	TYSH1H228H25ML
50	2700	278	22x30	H30	20	1.69	TYSH1H278H30ML
50	2700	278	25x25	J25	20	1.70	TYSH1H278J25ML
50	3300	338	22x35	H35	20	1.93	TYSH1H338H35ML
50	3300	338	25x35	J35	20	1.85	TYSH1H338J35ML
50	3900	398	22x40	H40	20	2.16	TYSH1H398H40ML
50	3900	398	25x35	J35	20	2.18	TYSH1H398J35ML
50	3900	398	30x25	K25	20	1.95	TYSH1H398K25ML
50	4700	478	22x45	H45	20	2.43	TYSH1H478H45ML
50	4700	478	30x30	K30	20	2.25	TYSH1H478K30ML
50	4700	478	35x25	L25	20	2.48	TYSH1H478L25ML
50	5600	568	22x50	H50	20	2.75	TYSH1H568H50ML
50	5600	568	25x40	J40	20	2.70	TYSH1H568J40ML
50	5600	568	30x35	K35	20	2.76	TYSH1H568K35ML
50	6800	688	25x50	J50	20	3.30	TYSH1H688J50ML
50	6800	688	30x40	K40	20	3.30	TYSH1H688K40ML
50	6800	688	35x30	L30	20	3.25	TYSH1H688L30ML
50	8200	828	30x45	K45	20	3.60	TYSH1H828K45ML
50	8200	828	35x35	L35	20	3.55	TYSH1H828L35ML
50	10000	109	30x50	K50	20	4.04	TYSH1H109K50ML
50	10000	109	35x40	L40	20	4.03	TYSH1H109L40ML
50	12000	129	35x45	L45	20	4.55	TYSH1H129L45ML
63	1200	128	22x25	H25	15	1.19	TYSH1J128H25ML
63	1800	188	22x30	H30	15	1.51	TYSH1J188H30ML
63	1800	188	25x25	J25	15	1.52	TYSH1J188J25ML
63	2200	228	22x35	H35	15	1.73	TYSH1J228H35ML
63	2200	228	25x30	J30	15	1.74	TYSH1J228J30ML
63	2700	278	22x40	H40	15	1.97	TYSH1J278H40ML
63	2700	278	25x35	J35	15	1.99	TYSH1J278J35ML
63	2700	278	30x25	K25	15	1.76	TYSH1J278K25ML
63	3300	338	22x50	H50	15	2.29	TYSH1J338H50ML
63	3300	338	25x40	J40	15	2.27	TYSH1J338J40ML
63	3300	338	30x30	K30	15	2.24	TYSH1J338K30ML
63	3300	338	35x25	L25	15	2.06	TYSH1J338L25ML
63	3900	398	25x45	J45	15	2.54	TYSH1J398J45ML
63	3900	398	30x35	K35	15	2.55	TYSH1J398K35ML
63	4700	478	25x50	J50	15	2.86	TYSH1J478J50ML
63	4700	478	30x40	K40	15	2.86	TYSH1J478K40ML
63	4700	478	35x30	L30	15	2.79	TYSH1J478L30ML
63	5600	568	30x45	K45	15	3.22	TYSH1J568K45ML
63	5600	568	35x35	L35	15	3.19	TYSH1J568L35ML
63	6800	688	30x50	K50	15	3.65	TYSH1J688K50ML
63	6800	688	35x40	L40	15	3.64	TYSH1J688L40ML
63	8200	828	35x45	L45	15	3.90	TYSH1J828L45ML
63	10000	109	35x50	L50	15	4.40	TYSH1J109L50ML
100	1200	128	22x40	H40	15	1.69	TYSH2A128H40ML

^{*}DF measured at 120Hz, 20°C

^{*}RC measured at 120Hz, 105°C

Standard Product Table (continued)

Rated Voltage V.DC	Capacitance		Case Size Dia x L	Case Code	Dissipation Factor (%) [*]	Ripple Current (mA) [*]	Part Number
	µF	Code					
100	1200	128	25x35	J35	15	1.71	TYSH2A128J35ML
100	1200	128	30x25	K25	15	1.68	TYSH2A128K25ML
100	1500	158	22x45	H45	15	1.94	TYSH2A158H45ML
100	1500	158	25x40	J40	15	1.98	TYSH2A158J40ML
100	1500	158	30x30	K30	15	1.95	TYSH2A158K30ML
100	1500	158	35x25	L25	15	1.98	TYSH2A158L25ML
100	1800	188	25x45	J45	15	2.23	TYSH2A188J45ML
100	1800	188	30x35	K35	15	2.50	TYSH2A188K35ML
100	2200	228	25x50	J50	15	2.53	TYSH2A228J50ML
100	2200	228	30x40	K40	15	2.70	TYSH2A228K40ML
100	2200	228	35x30	L30	15	2.50	TYSH2A228L30ML
100	2700	278	30x45	K45	15	2.88	TYSH2A278K45ML
100	2700	278	35x35	L35	15	2.86	TYSH2A278L35ML
100	3300	338	30x50	K50	15	3.28	TYSH2A338K50ML
100	3300	338	35x40	L40	15	3.27	TYSH2A338L40ML
100	3900	398	35x45	L45	15	3.67	TYSH2A398L45ML
100	4700	478	35x50	L50	15	3.67	TYSH2A478L50ML
100	5600	568	35x50	L50	15	3.80	TYSH2A568L50ML
160	270	277	22x25	H25	10	0.86	TYSH2C277H25ML
160	330	337	22x30	H30	10	1.20	TYSH2C337H30ML
160	390	397	22x30	H30	10	1.22	TYSH2C397H30ML
160	390	397	25x25	J25	10	1.15	TYSH2C397J25ML
160	470	477	22x35	H35	10	1.35	TYSH2C477H35ML
160	470	477	25x25	J25	10	1.33	TYSH2C477J25ML
160	470	477	25x30	J30	10	1.41	TYSH2C477J30ML
160	560	567	22x40	H40	10	1.50	TYSH2C567H40ML
160	560	567	25x30	J30	10	1.45	TYSH2C567J30ML
160	560	567	30x25	K25	10	1.40	TYSH2C567K25ML
160	680	687	22x45	H45	10	1.65	TYSH2C687H45ML
160	680	687	25x35	J35	10	1.65	TYSH2C687J35ML
160	680	687	30x25	K25	10	1.65	TYSH2C687K25ML
160	680	687	30x30	K30	10	1.72	TYSH2C687K30ML
160	820	827	22x50	H50	10	1.93	TYSH2C827H50ML
160	820	827	25x40	J40	10	1.85	TYSH2C827J40ML
160	820	827	30x30	K30	10	1.76	TYSH2C827K30ML
160	820	827	35x25	L25	15	1.91	TYSH2C827L25ML
160	1000	108	25x45	J45	10	2.20	TYSH2C108J45ML
160	1000	108	30x35	K35	10	2.02	TYSH2C108K35ML
160	1000	108	35x30	L30	15	2.44	TYSH2C108L30ML
160	1200	128	25x50	J50	10	2.45	TYSH2C128J50ML
160	1200	128	30x40	K40	10	2.35	TYSH2C128K40ML
160	1200	128	35x35	L35	15	2.50	TYSH2C128L35ML
160	1500	158	30x45	K45	10	2.82	TYSH2C158K45ML
160	1500	158	35x40	L40	15	2.70	TYSH2C158L40ML
160	1800	188	30x50	K50	10	3.31	TYSH2C188K50ML
160	1800	188	35x50	L50	15	3.10	TYSH2C188L50ML
200	220	227	22x25	H25	10	0.89	TYSH2D227H25ML
200	270	277	22x25	H25	10	0.87	TYSH2D277H25ML
200	270	277	25x25	J25	10	1.00	TYSH2D277J25ML
200	330	337	22x30	H30	10	1.13	TYSH2D337H30ML

^{*}DF measured at 120Hz, 20°C

^{*}RC measured at 120Hz, 105°C

Standard Product Table (continued)

Rated Voltage V.DC	Capacitance		Case Size Dia x L	Case Code	Dissipation Factor (%)*	Ripple Current (mA)*	Part Number
	µF	Code					
200	330	337	25x25	J25	10	1.13	TYSH2D337J25ML
200	390	397	22x35	H35	10	1.25	TYSH2D397H35ML
200	390	397	30x25	K25	10	1.20	TYSH2D397K25ML
200	470	477	22x40	H40	10	1.32	TYSH2D477H40ML
200	470	477	25x30	J30	10	1.32	TYSH2D477J30ML
200	470	477	25x35	J35	10	1.41	TYSH2D477J35ML
200	470	477	30x25	K25	10	1.50	TYSH2D477K25ML
200	560	567	22x45	H45	10	1.53	TYSH2D567H45ML
200	560	567	25x35	J35	10	1.50	TYSH2D567J35ML
200	560	567	30x30	K30	10	1.52	TYSH2D567K30ML
200	680	687	22x50	H50	10	1.74	TYSH2D687H50ML
200	680	687	25x40	J40	10	1.70	TYSH2D687J40ML
200	680	687	30x35	K35	10	1.73	TYSH2D687K35ML
200	680	687	35x25	L25	15	1.72	TYSH2D687L25ML
200	820	827	25x50	J50	10	2.04	TYSH2D827J50ML
200	820	827	30x40	K40	10	1.93	TYSH2D827K40ML
200	820	827	35x35	L35	15	1.93	TYSH2D827L35ML
200	1000	108	30x45	K45	10	2.20	TYSH2D108K45ML
200	1000	108	35x35	L35	15	2.20	TYSH2D108L35ML
200	1200	128	30x50	K50	10	2.60	TYSH2D128K50ML
200	1200	128	35x40	L40	15	2.65	TYSH2D128L40ML
200	1500	158	35x50	L50	15	2.80	TYSH2D158L50ML
200	1800	188	35x50	L50	15	3.47	TYSH2D188L50ML
250	180	187	22x30	H30	10	0.85	TYSH2E187H30ML
250	180	187	25x25	J25	10	0.85	TYSH2E187J25ML
250	220	227	22x35	H35	10	0.90	TYSH2E227H35ML
250	220	227	25x30	J30	10	1.00	TYSH2E227J30ML
250	270	277	22x35	H35	10	1.00	TYSH2E277H35ML
250	330	337	22x40	H40	10	1.10	TYSH2E337H40ML
250	330	337	25x30	J30	10	1.13	TYSH2E337J30ML
250	330	337	25x35	J35	10	1.20	TYSH2E337J35ML
250	390	397	22x45	H45	10	1.25	TYSH2E397H45ML
250	390	397	22x50	H50	10	1.49	TYSH2E397H50ML
250	390	397	25x35	J35	10	1.27	TYSH2E397J35ML
250	390	397	25x40	J40	10	1.49	TYSH2E397J40ML
250	470	477	22x50	H50	10	1.57	TYSH2E477H50ML
250	470	477	25x40	J40	10	1.38	TYSH2E477J40ML
250	470	477	25x45	J45	10	1.57	TYSH2E477J45ML
250	470	477	30x30	K30	10	1.37	TYSH2E477K30ML
250	470	477	30x35	K35	10	1.57	TYSH2E477K35ML
250	470	477	35x30	L30	15	1.30	TYSH2E477L30ML
250	560	567	25x45	J45	10	1.79	TYSH2E567J45ML
250	560	567	30x35	K35	10	1.58	TYSH2E567K35ML
250	560	567	30x40	K40	10	1.79	TYSH2E567K40ML
250	560	567	35x30	L30	15	1.79	TYSH2E567L30ML
250	680	687	25x50	J50	10	1.84	TYSH2E687J50ML
250	680	687	30x40	K40	10	2.00	TYSH2E687K40ML
250	680	687	35x35	L35	15	1.58	TYSH2E687L35ML
250	820	827	30x45	K45	10	1.85	TYSH2E827K45ML
250	820	827	30x50	K50	10	2.16	TYSH2E827K50ML

*DF measured at 120Hz, 20°C

*RC measured at 120Hz, 105°C

Standard Product Table (continued)

Rated Voltage V.DC	Capacitance		Case Size Dia x L	Case Code	Dissipation Factor (%) [*]	Ripple Current (mA) [*]	Part Number
	µF	Code					
250	820	827	35x40	L40	15	1.81	TYSH2E827L40ML
250	1000	108	35x45	L45	15	2.00	TYSH2E108L45ML
250	1200	128	35x45	L45	15	3.41	TYSH2E128L45ML
350	68	686	22x25	H25	15	0.51	TYSH2V686H25ML
350	82	826	22x25	H25	15	0.56	TYSH2V826H25ML
350	100	107	22x30	H30	15	0.69	TYSH2V107H30ML
350	100	107	25x25	J25	15	0.69	TYSH2V107J25ML
350	120	127	22x35	H35	15	0.75	TYSH2V127H35ML
350	150	157	22x40	H40	15	0.82	TYSH2V157H40ML
350	150	157	25x30	J30	15	0.83	TYSH2V157J30ML
350	150	157	30x25	K25	15	0.83	TYSH2V157K25ML
350	180	187	25x35	J35	15	0.92	TYSH2V187J35ML
350	180	187	30x30	K30	15	0.92	TYSH2V187K30ML
350	220	227	25x40	J40	15	1.04	TYSH2V227J40ML
350	220	227	30x30	K30	15	1.02	TYSH2V227K30ML
350	220	227	35x25	L25	15	1.04	TYSH2V227L25ML
350	270	277	30x35	K35	15	1.17	TYSH2V277K35ML
350	270	277	35x30	L30	15	1.20	TYSH2V277L30ML
350	330	337	30x45	K45	15	1.34	TYSH2V337K45ML
350	390	397	35x40	L40	15	1.47	TYSH2V397L40ML
350	470	477	35x45	L45	15	1.69	TYSH2V477L45ML
350	560	567	35x50	L50	15	1.90	TYSH2V567L50ML
400	68	686	22x30	H30	15	0.51	TYSH2G686H30ML
400	82	826	22x30	H30	15	0.58	TYSH2G826H30ML
400	82	826	25x25	J25	15	0.64	TYSH2G826J25ML
400	100	107	22x35	H35	15	0.61	TYSH2G107H35ML
400	100	107	25x30	J30	15	0.64	TYSH2G107J30ML
400	120	127	22x35	H35	15	0.67	TYSH2G127H35ML
400	120	127	22x40	H40	15	0.72	TYSH2G127H40ML
400	120	127	25x30	J30	15	0.69	TYSH2G127J30ML
400	120	127	25x35	J35	15	0.72	TYSH2G127J35ML
400	120	127	30x25	K25	15	0.76	TYSH2G127K25ML
400	150	157	22x40	H40	15	0.77	TYSH2G157H40ML
400	150	157	22x50	H50	15	0.82	TYSH2G157H50ML
400	150	157	25x35	J35	15	0.78	TYSH2G157J35ML
400	150	157	25x40	J40	15	0.84	TYSH2G157J40ML
400	150	157	30x30	K30	15	0.76	TYSH2G157K30ML
400	180	187	22x50	H50	15	0.95	TYSH2G187H50ML
400	180	187	25x40	J40	15	0.83	TYSH2G187J40ML
400	180	187	25x45	J45	15	0.94	TYSH2G187J45ML
400	180	187	30x30	K30	15	0.82	TYSH2G187K30ML
400	180	187	30x35	K35	15	0.92	TYSH2G187K35ML
400	180	187	35x25	L25	15	0.90	TYSH2G187L25ML
400	220	227	25x50	J50	15	1.07	TYSH2G227J50ML
400	220	227	30x35	K35	15	0.91	TYSH2G227K35ML
400	220	227	30x40	K40	15	1.06	TYSH2G227K40ML
400	220	227	35x30	L30	15	1.08	TYSH2G227L30ML
400	270	277	25x50	J50	15	1.21	TYSH2G277J50ML
400	270	277	30x40	K40	15	1.10	TYSH2G277K40ML
400	270	277	30x45	K45	15	1.21	TYSH2G277K45ML

^{*}DF measured at 120Hz, 20°C

^{*}RC measured at 120Hz, 105°C

Standard Product Table (continued)

Rated Voltage V.DC	Capacitance		Case Size Dia x L	Case Code	Dissipation Factor (%)*	Ripple Current (mA)*	Part Number
	µF	Code					
400	270	277	35x35	L35	15	1.12	TYSH2G277L35ML
400	330	337	30x45	K45	15	1.39	TYSH2G337K45ML
400	330	337	35x40	L40	15	1.25	TYSH2G337L40ML
400	390	397	30x50	K50	15	1.55	TYSH2G397K50ML
400	390	397	35x45	L45	15	1.55	TYSH2G397L45ML
400	470	477	35x50	L50	15	1.72	TYSH2G477L50ML
450	56	566	22x25	H25	15	0.40	TYSH2W566H25ML
450	68	686	22x30	H30	15	0.50	TYSH2W686H30ML
450	68	686	25x25	J25	15	0.50	TYSH2W686J25ML
450	82	826	22x35	H35	15	0.56	TYSH2W826H35ML
450	100	107	22x40	H40	15	0.64	TYSH2W107H40ML
450	100	107	25x30	J30	15	0.57	TYSH2W107J30ML
450	100	107	30x25	K25	15	0.64	TYSH2W107K25ML
450	120	127	22x45	H45	15	0.72	TYSH2W127H45ML
450	120	127	25x35	J35	15	0.71	TYSH2W127J35ML
450	150	157	22x50	H50	15	0.79	TYSH2W157H50ML
450	150	157	25x40	J40	15	0.75	TYSH2W157J40ML
450	150	157	30x30	K30	15	0.74	TYSH2W157K30ML
450	150	157	35x25	L25	15	0.75	TYSH2W157L25ML
450	180	187	25x45	J45	15	0.84	TYSH2W187J45ML
450	180	187	30x35	K35	15	0.87	TYSH2W187K35ML
450	220	227	25x50	J50	15	0.98	TYSH2W227J50ML
450	220	227	30x40	K40	15	0.98	TYSH2W227K40ML
450	220	227	35x30	L30	15	1.00	TYSH2W227L30ML
450	270	277	30x45	K45	15	1.15	TYSH2W277K45ML
450	270	277	35x35	L35	15	1.17	TYSH2W277L35ML
450	330	337	30x50	K50	15	1.38	TYSH2W337K50ML
450	330	337	35x45	L45	15	1.70	TYSH2W337L45ML
450	390	397	35x50	L50	15	1.94	TYSH2W397L50ML
450	470	477	35x50	L50	15	2.13	TYSH2W477L50ML

*DF measured at 120Hz, 20°C

*RC measured at 120Hz, 85°C

Product Availability Chart

Capacitance		Rated Voltage (V.DC)											
		16				25				35			
µF	Code	Dia x L	Dia x L	Dia x L	Dia x L	Dia x L	Dia x L	Dia x L	Dia x L	Dia x L	Dia x L	Dia x L	Dia x L
4700	478					22 x 25						25 x 25	
5600	568					22 x 25						22 x 35	25 x 30
6800	688	22 x 25				22 x 30	25 x 25					22 x 40	25 x 35
8200	828	22 x 25				22 x 35	25 x 30	30 x 25				22 x 50	25 x 40
10000	109	22 x 30	25 x 30			22 x 40	25 x 35					25 x 45	30 x 35
12000	129	22 x 35	25 x 30	30 x 25		22 x 45	25 x 40	30 x 30	35 x 25			25 x 50	30 x 40
15000	159	22 x 40	25 x 35				25 x 45	30 x 35	35 x 30				30 x 45
18000	189	22 x 45	25 x 40	30 x 30	35 x 25		25 x 50	30 x 40					35 x 40
22000	229		25 x 45	30 x 35				30 x 45	35 x 35				35 x 50

Product Availability Chart (continued)

Capacitance		Rated Voltage (V.DC)											
		50				63				100			
µF	Code	Dia x L	Dia x L	Dia x L	Dia x L	Dia x L	Dia x L	Dia x L	Dia x L	Dia x L	Dia x L	Dia x L	Dia x L
1200	128					22 x 25				22 x 40	25 x 35	30 x 25	
1500	158									22 x 45	25 x 40	30 x 30	35 x 25
1800	188	22 x 25				22 x 30	25 x 25				25 x 45	30 x 35	
2200	228	22 x 25				22 x 35	25 x 30				25 x 50	30 x 40	35 x 30
2700	278	22 x 30	25 x 25			22 x 40	25 x 35	30 x 25				30 x 45	35 x 35
3300	338	22 x 35	25 x 35			22 x 50	25 x 40	30 x 30	35 x 25			30 x 50	35 x 40
3900	398	22 x 40	25 x 35	30 x 25			25 x 45	30 x 35					35 x 45
4700	478	22 x 45		30 x 30	35 x 25		25 x 50	30 x 40	35 x 30				35 x 50
5600	568	22 x 50	25 x 40	30 x 35				30 x 45	35 x 35				35 x 50
6800	688		25 x 50	30 x 40	35 x 30			30 x 50	35 x 40				
8200	828			30 x 45	35 x 35				35 x 45				
10000	109			30 x 50	35 x 40				35 x 50				
12000	129				35 x 45								

Capacitance		Rated Voltage (V.DC)											
		160				200				250			
µF	Code	Dia x L	Dia x L	Dia x L	Dia x L	Dia x L	Dia x L	Dia x L	Dia x L	Dia x L	Dia x L	Dia x L	Dia x L
180	187									22 x 30	25 x 25		
220	227					22 x 25				22 x 35	25 x 30		
270	277	22 x 25				22 x 25	25 x 25			22 x 35			
330	337	22 x 30				22 x 30	25 x 25			22 x 40	25 x 30		
390	397	22 x 30	25 x 25			22 x 35		30 x 25		22 x 45	25 x 35		
470	477	22 x 35	25 x 25			22 x 40	25 x 30	30 x 25		22 x 50	25 x 40		
560	567	22 x 40	25 x 30	30 x 25		22 x 45	25 x 35	30 x 30			25 x 45	30 x 35	35 x 30
680	687	22 x 45	25 x 35	30 x 25		22 x 50	25 x 40	30 x 35	35 x 25		25 x 50	30 x 40	35 x 35
820	827	22 x 50	25 x 40	30 x 30	35 x 25		25 x 50	30 x 40	35 x 35			30 x 45	35 x 40
1000	108		25 x 45	30 x 35	35 x 30			30 x 45	35 x 35				35 x 45
1200	128		25 x 50	30 x 40	35 x 35			30 x 50	35 x 40				35 x 45
1500	158			30 x 45	35 x 40				35 x 50				
1800	188			30 x 50	35 x 50				35 x 50				

Capacitance		Rated Voltage (V.DC)											
		350				400				450			
µF	Code	Dia x L	Dia x L	Dia x L	Dia x L	Dia x L	Dia x L	Dia x L	Dia x L	Dia x L	Dia x L	Dia x L	Dia x L
56	566									22 x 25			
68	686	22 x 25				22 x 30				22 x 30	25 x 25		
82	826	22 x 25				22 x 30	25 x 25			22 x 35			
100	107	22 x 30	25 x 25			22 x 35	25 x 30			22 x 40	25 x 30	30 x 25	
120	127	22 x 35				22 x 35	25 x 30	30 x 25		22 x 45	25 x 35		
150	157	22 x 40	25 x 30	30 x 25		22 x 40	25 x 35	30 x 30		22 x 50	25 x 40	30 x 30	35 x 25
180	187		25 x 35	30 x 30		22 x 50	25 x 40	30 x 30	35 x 25		25 x 45	30 x 35	
220	227		25 x 40	30 x 30	35 x 25		25 x 50	30 x 35	35 x 30		25 x 50	30 x 40	35 x 30
270	277			30 x 35	35 x 30			25 x 50	30 x 40	35 x 35		30 x 45	35 x 35
330	337			30 x 45	35 x 40				30 x 45	35 x 40		30 x 50	35 x 45
390	397								30 x 50	35 x 45			35 x 50
470	477				35 x 45				35 x 50				35 x 50
560	567				35 x 50								

Characteristics - Electrical

													Test Conditions JIS C5101-4		
Operating Temp. Range	-40°C ~ +105°C												—		
Rated Voltage	DC 16 ~ 450V												105°C		
Capacitance	56 ~ 22000µF												105°C		
Capacitance Tolerance	±20%												120Hz, 20°C		
Leakage Current	I = 0.02CV or 1.5mA whichever is smaller (after 5 minutes)												C = rated capacitance (µF) V = rated DC working voltage (V) Temperature = 20°C		
Dissipation Factor (Tanδ)	Rated Voltage	16	25	35	50	63	100	160	200	250	350	400	450	120Hz, 20°C	
	Tanδ max	0.40	0.30	0.25	0.20	0.15	0.15	0.10*	0.10*	0.10*	0.15	0.15	0.15		
Low Temperature Characteristics	Rated Voltage	16	25	35	50	63	100	160	200	250	350	400	450	120Hz	
	Impedance Ratio														
	Z(-25°C) / Z(+20°C)	4	3	3	2	2	2	4	4	4	4	8	8		
	Z(-40°C) / Z(+20°C)	15	10	8	6	6	5	4	8	10	16	18	20		
Load Life Test	Test Time	2000 Hrs											Specification satisfied when the capacitors are restored to 20°C after the rated voltage applied with rated ripple current for 2000 hrs at 105°C		
	Capacitance Change	Within ±20% of initial value													
	Dissipation Factor	Less than 200% of specified value													
	Leakage Current	Within specified value													
Shelf Life Test	Test Time	1000 hrs											Specifications satisfied when the capacitors are restored to 20°C after exposing them for 1000 hrs at 105°C without voltage applied. The rated voltage shall be applied to the capacitors before the measurements. (Refer to JIS C 5102)		
	Capacitance Change	Within ±20% of initial value													
	Dissipation Factor	Less than 150% of specified value													
	Leakage Current	Within specified value													
Ripple Current & Frequency Multipliers	Frequency (Hz)	60		120		500		1k		≥10k		—			
	VDC ≤ 100	0.92		1.00		1.13		1.19		1.20					
	VDC 160~250	0.81		1.00		1.32		1.45		1.50					
	VDC 350~450	0.77		1.00		1.30		1.41		1.43					

Dimensions

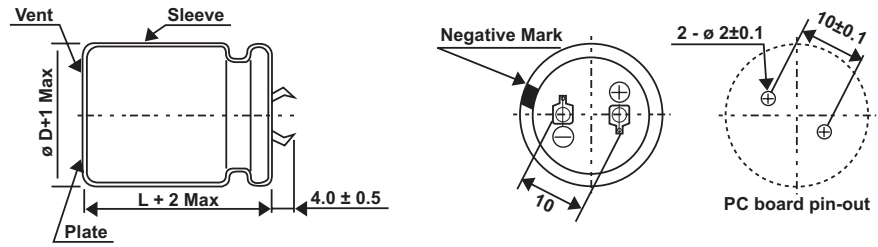

Case Code	Dimensions (mm)	
	Dia	L
H25	22	25
H30	22	30
H35	22	35
H40	22	40
H45	22	45
H50	22	50
J25	25	25
J30	25	30
J35	25	35
J40	25	40
J45	25	45
J50	25	50
K25	30	25
K30	30	30
K35	30	35
K40	30	40
K45	30	45
K50	30	50
L25	35	25
L30	35	30
L35	35	35
L40	35	40
L45	35	45
L50	35	50

How to Order

TYSH	1C	688	H25	M	L
Common Part	Voltage Code	Capacitance	Case Code	Tolerance	Packaging
TYSH	1C (16V) 1E (25V) 1V (35V) 1H (50V) 1J (63V) 2A (100V) 2C (160V) 2D (200V) 2E (250V) 2V (350V) 2G (400V) 2W (450V)	e.g. 688	e.g. H25	M (20%)	L = Loose (bulk)

Tyco Part No.	Brand Part No.	Page No.	Tyco Part No.	Brand Part No.	Page No.	Tyco Part No.	Brand Part No.	Page No.	Tyco Part No.	Brand Part No.	Page No.
1676849-5	TYC0201A109JFT	26	1676859-5	TYC0805A109JTT	26	1676872-3	TYC0603B151KHT	26	1676891-4	TYC0402D183ZFT	26
1676849-6	TYC0201A129JFT	26	1676859-6	TYC0805A129JTT	26	1676872-4	TYC0603B181KHT	26	1676891-5	TYC0402D223ZFT	26
1676849-7	TYC0201A159JFT	26	1676859-7	TYC0805A159JTT	26	1676872-5	TYC0603B221KHT	26	1676893-1	TYC0603D103ZFT	26
1676849-8	TYC0201A189JFT	26	1676859-8	TYC0805A189JTT	26	1676872-6	TYC0603B271KHT	26	1676893-2	TYC0603D123ZFT	26
1676849-9	TYC0201A229JFT	26	1676859-9	TYC0805A229JTT	26	1676872-7	TYC0603B331KHT	26	1676893-3	TYC0603D153ZFT	26
1676850-1	TYC0402A478JFT	26	1676860-5	TYC1206A109JGT	26	1676872-8	TYC0603B391KHT	26	1676893-4	TYC0603D183ZFT	26
1676850-2	TYC0402A568JFT	26	1676860-6	TYC1206A129JGT	26	1676872-9	TYC0603B471KHT	26	1676893-5	TYC0603D223ZFT	26
1676850-3	TYC0402A688JFT	26	1676860-7	TYC1206A159JGT	26	1676875-4	TYC0805B181KFT	26	1676893-6	TYC0603D273ZFT	26
1676850-4	TYC0402A828JFT	26	1676860-8	TYC1206A189JGT	26	1676875-5	TYC0805B221KFT	26	1676893-7	TYC0603D333ZFT	26
1676850-5	TYC0402A109JFT	26	1676860-9	TYC1206A229JGT	26	1676875-6	TYC0805B271KFT	26	1676893-8	TYC0603D393ZFT	26
1676850-6	TYC0402A129JFT	26	1676861-5	TYC1206A109JHT	26	1676875-7	TYC0805B331KFT	26	1676893-9	TYC0603D473ZFT	26
1676850-7	TYC0402A159JFT	26	1676861-6	TYC1206A129JHT	26	1676875-8	TYC0805B391KFT	26	1676894-1	TYC0603D103ZGT	26
1676850-8	TYC0402A189JFT	26	1676861-7	TYC1206A159JHT	26	1676875-9	TYC0805B471KFT	26	1676894-2	TYC0603D123ZGT	26
1676850-9	TYC0402A229JFT	26	1676861-8	TYC1206A189JHT	26	1676876-4	TYC0805B181KGT	26	1676894-3	TYC0603D153ZGT	26
1676851-1	TYC0402A478JGT	26	1676861-9	TYC1206A229JHT	26	1676876-5	TYC0805B221KGT	26	1676894-4	TYC0603D183ZGT	26
1676851-2	TYC0402A568JGT	26	1676862-5	TYC1206A109JHT	26	1676876-6	TYC0805B271KGT	26	1676894-5	TYC0603D223ZGT	26
1676851-3	TYC0402A688JGT	26	1676862-6	TYC1206A129JHT	26	1676876-7	TYC0805B331KGT	26	1676894-6	TYC0603D273ZGT	26
1676851-4	TYC0402A828JGT	26	1676862-7	TYC1206A159JHT	26	1676876-8	TYC0805B391KGT	26	1676894-7	TYC0603D333ZGT	26
1676851-5	TYC0402A109JGT	26	1676862-8	TYC1206A189JHT	26	1676876-9	TYC0805B471KGT	26	1676894-8	TYC0603D393ZGT	26
1676851-6	TYC0402A129JGT	26	1676862-9	TYC1206A229JHT	26	1676877-4	TYC0805B181KHT	26	1676894-9	TYC0603D473ZGT	26
1676851-7	TYC0402A159JGT	26	1676863-5	TYC1206A109JLT	26	1676877-5	TYC0805B221KHT	26	1676896-9	TYC0805D473ZFT	26
1676851-8	TYC0402A189JGT	26	1676863-6	TYC1206A129JLT	26	1676877-6	TYC0805B271KHT	26	1676897-9	TYC0805D473ZGT	26
1676851-9	TYC0402A229JGT	26	1676863-7	TYC1206A159JLT	26	1676877-7	TYC0805B331KHT	26	1676900-1	TYC1206D103ZFT	26
1676853-1	TYC0603A478JFT	26	1676863-8	TYC1206A189JLT	26	1676877-8	TYC0805B391KHT	26	1676900-2	TYC1206D123ZFT	26
1676853-2	TYC0603A568JFT	26	1676863-9	TYC1206A229JLT	26	1676877-9	TYC0805B471KHT	26	1676900-3	TYC1206D153ZFT	26
1676853-3	TYC0603A688JFT	26	1676864-1	TYC0402B101KDT	26	1676878-4	TYC0805B181KJT	26	1676900-4	TYC1206D183ZFT	26
1676853-4	TYC0603A828JFT	26	1676864-2	TYC0402B121KDT	26	1676878-5	TYC0805B221KJT	26	1676900-5	TYC1206D223ZFT	26
1676853-5	TYC0603A109JFT	26	1676864-3	TYC0402B151KDT	26	1676878-6	TYC0805B271KJT	26	1676900-6	TYC1206D273ZFT	26
1676853-6	TYC0603A129JFT	26	1676864-4	TYC0402B181KDT	26	1676878-7	TYC0805B331KJT	26	1676900-7	TYC1206D333ZFT	26
1676853-7	TYC0603A159JFT	26	1676864-5	TYC0402B221KDT	26	1676878-8	TYC0805B391KJT	26	1676900-8	TYC1206D393ZFT	26
1676853-8	TYC0603A189JFT	26	1676864-6	TYC0402B271KDT	26	1676878-9	TYC0805B471KJT	26	1676900-9	TYC1206D473ZFT	26
1676853-9	TYC0603A229JFT	26	1676864-7	TYC0402B331KDT	26	1676882-4	TYC1206B181KGT	26	1676901-1	TYC1206D103ZGT	26
1676854-1	TYC0603A478JGT	26	1676864-8	TYC0402B391KDT	26	1676882-5	TYC1206B221KGT	26	1676901-2	TYC1206D123ZGT	26
1676854-2	TYC0603A568JGT	26	1676864-9	TYC0402B471KDT	26	1676882-6	TYC1206B271KGT	26	1676901-3	TYC1206D153ZGT	26
1676854-3	TYC0603A688JGT	26	1676865-1	TYC0402B101KET	26	1676882-7	TYC1206B331KGT	26	1676901-4	TYC1206D183ZGT	26
1676854-4	TYC0603A828JGT	26	1676865-2	TYC0402B121KET	26	1676882-8	TYC1206B391KGT	26	1676901-5	TYC1206D223ZGT	26
1676854-5	TYC0603A109JGT	26	1676865-3	TYC0402B151KET	26	1676882-9	TYC1206B471KGT	26	1676901-6	TYC1206D273ZGT	26
1676854-6	TYC0603A129JGT	26	1676865-4	TYC0402B181KET	26	1676883-4	TYC1206B181KHT	26	1676901-7	TYC1206D333ZGT	26
1676854-7	TYC0603A159JGT	26	1676865-5	TYC0402B221KET	26	1676883-5	TYC1206B221KHT	26	1676901-8	TYC1206D393ZGT	26
1676854-8	TYC0603A189JGT	26	1676865-6	TYC0402B271KET	26	1676883-6	TYC1206B271KHT	26	1676901-9	TYC1206D473ZGT	26
1676854-9	TYC0603A229JGT	26	1676865-7	TYC0402B331KET	26	1676883-7	TYC1206B331KHT	26	1676902-1	TYTSA0G335MTRF	6
1676855-1	TYC0603A478JHT	26	1676865-8	TYC0402B391KET	26	1676883-8	TYC1206B391KHT	26	1676902-2	TYTSB0G106MTRF	6
1676855-2	TYC0603A568JHT	26	1676865-9	TYC0402B471KET	26	1676883-9	TYC1206B471KHT	26	1676902-3	TYTSC0G336MTRF	6
1676855-3	TYC0603A688JHT	26	1676866-1	TYC0402B101KFT	26	1676884-4	TYC1206B181KJT	26	1676902-4	TYTSD0G688MTRF	6
1676855-4	TYC0603A828JHT	26	1676866-2	TYC0402B121KFT	26	1676884-5	TYC1206B221KJT	26	1676902-5	TYTSA0J225MTRF	6
1676855-5	TYC0603A109JHT	26	1676866-3	TYC0402B151KFT	26	1676884-6	TYC1206B271KJT	26	1676902-6	TYTSS0J685MTRF	6
1676855-6	TYC0603A129JHT	26	1676866-4	TYC0402B181KFT	26	1676884-7	TYC1206B331KJT	26	1676902-7	TYTSC0J226MTRF	6
1676855-7	TYC0603A159JHT	26	1676866-5	TYC0402B221KFT	26	1676884-8	TYC1206B391KJT	26	1676902-8	TYTSD0J476MTRF	6
1676855-8	TYC0603A189JHT	26	1676866-6	TYC0402B271KFT	26	1676884-9	TYC1206B471KJT	26	1676902-9	TYTSA1A155MTRF	6
1676855-9	TYC0603A229JHT	26	1676866-7	TYC0402B331KFT	26	1676885-4	TYC1206B181KLT	26	1676903-1	TYTMA0E685MTRF	9
1676856-1	TYC0805A478JFT	26	1676866-8	TYC0402B391KFT	26	1676885-5	TYC1206B221KLT	26	1676903-2	TYTMA0E106MTRF	9
1676856-2	TYC0805A568JFT	26	1676866-9	TYC0402B471KFT	26	1676885-6	TYC1206B271KLT	26	1676903-3	TYTMA0E156MTRF	9
1676856-3	TYC0805A688JFT	26	1676867-1	TYC0402B101KGT	26	1676885-7	TYC1206B331KLT	26	1676903-4	TYTMA0E225MTRF	9
1676856-4	TYC0805A828JFT	26	1676867-2	TYC0402B121KGT	26	1676885-8	TYC1206B391KLT	26	1676903-5	TYTMB0E226MTRF	9
1676856-5	TYC0805A109JFT	26	1676867-3	TYC0402B151KGT	26	1676885-9	TYC1206B471KLT	26	1676903-6	TYTMA0E336MTRF	9
1676856-6	TYC0805A129JFT	26	1676867-4	TYC0402B181KGT	26	1676886-2	TYC0402C123ZDT	26	1676903-7	TYTMB0E336MTRF	9
1676856-7	TYC0805A159JFT	26	1676867-5	TYC0402B221KGT	26	1676886-3	TYC0402C153ZDT	26	1676903-8	TYTMA0E476MTRF	9
1676856-8	TYC0805A189JFT	26	1676867-6	TYC0402B271KGT	26	1676886-4	TYC0402C183ZDT	26	1676903-9	TYTMB0E476MTRF	9
1676856-9	TYC0805A229JFT	26	1676867-7	TYC0402B331KGT	26	1676886-5	TYC0402C223ZDT	26	1676904-1	TYTMA1C1155MTRF	9
1676857-1	TYC0805A478JGT	26	1676867-8	TYC0402B391KGT	26	1676886-6	TYC0402C273ZDT	26	1676904-2	TYTMA1C225MTRF	9
1676857-2	TYC0805A568JGT	26	1676867-9	TYC0402B471KGT	26	1676886-7	TYC0402C333ZDT	26	1676904-3	TYTMA1C475MTRF	9
1676857-3	TYC0805A688JGT	26	1676870-1	TYC0603B101KFT	26	1676886-8	TYC0402C393ZDT	26	1676904-4	TYTMA1C475MTRF	9
1676857-4	TYC0805A828JGT	26	1676870-2	TYC0603B121KFT	26	1676886-9	TYC0402C473ZDT	26	1676904-5	TYTMB1C475MTRF	9
1676857-5	TYC0805A109JGT	26	1676870-3	TYC0603B151KFT	26	1676887-2	TYC0402C123ZET	26	1676904-6	TYTMA1C685MTRF	9
1676857-6	TYC0805A129JGT	26	1676870-4	TYC0603B181KFT	26	1676887-3	TYC0402C153ZET	26	1676904-7	TYTMB1C685MTRF	9
1676857-7	TYC0805A159JGT	26	1676870-5	TYC0603B221KFT	26	1676887-4	TYC0402C183ZET	26	1676904-8	TYTMA1C106MTRF	9
1676857-8	TYC0805A189JGT	26	1676870-6	TYC0603B271KFT	26	1676887-5	TYC0402C223ZET	26	1676904-9	TYTMB1C106MTRF	9
1676857-9	TYC0805A229JGT	26	1676870-7	TYC0603B331KFT	26	1676887-6	TYC0402C273ZET	26	1676906-1	TYTPP0E225MTRF	15
1676858-1	TYC0805A478JHT	26	1676870-8	TYC0603B391KFT	26	1676887-7	TYC0402C333ZET	26	1676906-2	TYTPP0E335MTRF	15
1676858-2	TYC0805A568JHT	26	1676870-9	TYC0603B471KFT	26	1676890-1	TYC0402D103ZET	26	1676906-3	TYTPP0E475MTRF	15
1676858-3	TYC0805A688JHT	26	1676871-1	TYC0603B101KGT	26	1676890-2	TYC0402D123ZET	26	1676906-4	TYTPP0E685MTRF	15
1676858-4	TYC0805A828JHT	26	1676871-2	TYC0603B121KGT	26	1676890-3	TYC0402D153ZET	26	1676906-5	TYTPP0E106MTRF	15
1676858-5	TYC0805A109JHT	26	1676871-3	TYC0603B151KGT	26	1676890-4	TYC0402D183ZET	26	1676906-6	TYTPP0E156MTRF	15
1676858-6	TYC0805A129JHT	26	1676871-4	TYC0603B181KGT	26	1676890-5	TYC0402D223ZET	26	1676906-7	TYTPP0E225MTRF	15
1676858-7	TYC0805A159JHT	26	1676871-5	TYC0603B221KGT	26	1676890-6	TYC0402D273ZET	26	1676906-8	TYTPP0G155MTRF	15
1676858-8	TYC0805A189JHT	26	1676871-6	TYC0603B271KGT	26	1676890-7	TYC0402D333ZET	26	1676906-9	TYTPP0G225MTRF	15
1676858-9	TYC0805A229JHT	26	1676871-7	TYC0603B331KGT	26	1676890-8	TYC0402D393ZET	26	1676909-1	TYTRB0J106MTRF	18
1676859-1	TYC0805A478JTT	26	1676871-8	TYC							

Tyco Part No.	Brand Part No.	Page No.	Tyco Part No.	Brand Part No.	Page No.	Tyco Part No.	Brand Part No.	Page No.	Tyco Part No.	Brand Part No.	Page No.
1676909-6	TYTRDOJ688MTRF	18	1879065-6	TYTRDOG227MTRF	18	1879298-7	TYAH2A476D21ML	85	1879307-7	TYSV1C159J30ML	92
1676909-7	TYTRDOJ107MTRF	18	1879065-7	TYTRDOG337KTRF	18	1879298-8	TYAH2A107E22ML	85	1879307-8	TYSV1C159K25ML	92
1676909-8	TYTRDOJ157MTRF	18	1879065-8	TYTRDOG337MTRF	18	1879298-9	TYAH2A227F28ML	85	1879307-9	TYSV1C189H40ML	92
1879054-2	TYTMD1E106MTRF	9	1879065-9	TYTRDOG477KTRF	18	1879299-1	TYRV0J336A11ML	53	1879308-1	TYSV1J109L40ML	92
1879054-3	TYTMD1E476MTRF	9	1879290-1	TYEV0J226D55MTR	36	1879299-2	TYRV0J476A11ML	53	1879308-2	TYSV1J129L50ML	92
1879054-4	TYTMD1H155MTRF	9	1879290-2	TYEV0J336D55MTR	36	1879299-3	TYRV0J107A11ML	53	1879308-3	TYSV2A128H30ML	92
1879054-5	TYTMD1H225MTRF	9	1879290-3	TYEV0J476D55MTR	36	1879299-4	TYRV0J227A11ML	53	1879308-4	TYSV2A137H25ML	92
1879054-6	TYTMD1H685MTRF	9	1879290-4	TYEV0J476E55MTR	36	1879299-5	TYRV0J337B11ML	53	1879308-5	TYSV2A158H35ML	92
1879054-7	TYTMD1V335MTRF	9	1879290-5	TYEV0J107E55MTR	36	1879299-6	TYRV0J477B11ML	53	1879308-6	TYSV2A158J30ML	92
1879054-8	TYTMD1V475MTRF	9	1879290-6	TYEV0J107F55MTR	36	1879299-7	TYRV0J108C11ML	53	1879308-7	TYSV2A158K25ML	92
1879054-9	TYTMD1V685MTRF	9	1879290-7	TYEV0J227F55MTR	36	1879299-8	TYRV0J228D20ML	53	1879308-8	TYSV2A188H40ML	92
1879055-1	TYTMA0E106KTRF	9	1879290-8	TYEV0J337F80MTR	36	1879299-9	TYRV0J338D20ML	53	1879308-9	TYSV2A188J35ML	92
1879055-2	TYTMA0E156KTRF	9	1879290-9	TYEV0J337G68MTR	36	1879300-1	TYRV1J107D12ML	53	1879309-1	TYSV2E227J25ML	92
1879055-3	TYTMA0E226KTRF	9	1879291-1	TYEH0J226D55MTR	40	1879300-2	TYRV1J227D16ML	53	1879309-2	TYSV2E277H30ML	92
1879055-4	TYTMA0E336KTRF	9	1879291-2	TYEH0J336E55MTR	40	1879300-3	TYRV1J337D20ML	53	1879309-3	TYSV2E277J25ML	92
1879055-5	TYTMA0E476KTRF	9	1879291-3	TYEH0J476E55MTR	40	1879300-4	TYRV1J477E20ML	53	1879309-4	TYSV2E337H30ML	92
1879055-6	TYTMA0E685KTRF	9	1879291-4	TYEH0J107F55MTR	40	1879300-5	TYRV1J108F25ML	53	1879309-5	TYSV2E337H35ML	92
1879055-7	TYTMA0G106KTRF	9	1879291-5	TYEH0J477G10MTR	40	1879300-6	TYRV1J228G40ML	53	1879309-6	TYSV2E337J25ML	92
1879055-8	TYTMA0G156KTRF	9	1879291-6	TYEH0J477H10MTR	40	1879300-7	TYRV1J338H40ML	53	1879309-7	TYSV2E337H30ML	92
1879055-9	TYTMA0G226KTRF	9	1879291-7	TYEH0J108H10MTR	40	1879300-8	TYRV1J478J40ML	53	1879309-8	TYSV2E397H35ML	92
1879056-1	TYTMB1D106KTRF	9	1879291-8	TYEH1A228E55MTR	40	1879300-9	TYRV2A104A11ML	53	1879309-9	TYSV2E397H40ML	92
1879056-2	TYTMB1D155KTRF	9	1879291-9	TYEH1A336E55MTR	40	1879301-1	TYRH0J336A11ML	60	1879310-1	TYSV2G277J45ML	92
1879056-3	TYTMB1D475KTRF	9	1879292-1	TYEL0J226D60MTR	46	1879301-2	TYRH0J476A11ML	60	1879310-2	TYSV2G277K35ML	92
1879056-4	TYTMB1D335KTRF	9	1879292-2	TYEL0J336E60MTR	46	1879301-3	TYRH0J107A11ML	60	1879310-3	TYSV2G277L30ML	92
1879056-5	TYTMB1D685KTRF	9	1879292-3	TYEL0J476E60MTR	46	1879301-4	TYRH0J227A11ML	60	1879310-4	TYSV2G337J50ML	92
1879056-6	TYTMB1E155KTRF	9	1879292-4	TYEL0J107F60MTR	46	1879301-5	TYRH0J337B11ML	60	1879310-5	TYSV2G337K40ML	92
1879056-7	TYTMB1E225KTRF	9	1879292-5	TYEL0J227F80MTR	46	1879301-6	TYRH0J477B11ML	60	1879310-6	TYSV2G337L30ML	92
1879056-8	TYTMB1E335KTRF	9	1879292-6	TYEL0J337G10MTR	46	1879301-7	TYRH0J108C11ML	60	1879310-7	TYSV2G337L35ML	92
1879056-9	TYTMB1E476KTRF	9	1879292-7	TYEL0J477H10MTR	46	1879301-8	TYRH0J228D20ML	60	1879310-8	TYSV2G397K40ML	92
1879057-1	TYTMD1C107KTRF	9	1879292-8	TYEL0J108H10MTR	46	1879301-9	TYRH0J338D20ML	60	1879310-9	TYSV2G397K45ML	92
1879057-2	TYTMD1C226KTRF	9	1879292-9	TYEL1A226E60MTR	46	1879302-1	TYRH1J338H40ML	60	1879311-1	TYSH1C688H25ML	103
1879057-3	TYTMD1C336KTRF	9	1879293-1	TYEE0J226D55MTR	44	1879302-2	TYRH1J478J40ML	60	1879311-2	TYSH1C828H25ML	103
1879057-4	TYTMD1C476KTRF	9	1879293-2	TYEE0J336E55MTR	44	1879302-3	TYRH2A104A11ML	60	1879311-3	TYSH1C109H30ML	103
1879057-5	TYTMD1C688KTRF	9	1879293-3	TYEE0J476E55MTR	44	1879302-4	TYRH2A224A11ML	60	1879311-4	TYSH1C109J30ML	103
1879057-6	TYTMD1D226KTRF	9	1879293-4	TYEE0J107F55MTR	44	1879302-5	TYRH2A334A11ML	60	1879311-5	TYSH1C129H35ML	103
1879057-7	TYTMD1D476KTRF	9	1879293-5	TYEE0J227F80MTR	44	1879302-6	TYRH2A474A11ML	60	1879311-6	TYSH1C129J30ML	103
1879057-8	TYTMD1E106KTRF	9	1879293-6	TYEE1A226E55MTR	44	1879302-7	TYRH2A105A11ML	60	1879311-7	TYSH1C129K25ML	103
1879057-9	TYTMD1E476KTRF	9	1879293-7	TYEE1A336E55MTR	44	1879302-8	TYRH2A225A11ML	60	1879311-8	TYSH1C159H40ML	103
1879058-1	TYTRD1D476KTRF	18	1879293-8	TYEE1A476F55MTR	44	1879302-9	TYRH2A335A11ML	60	1879311-9	TYSH1C159J35ML	103
1879058-2	TYTRD1E106KTRF	18	1879293-9	TYEE1A107F55MTR	44	1879303-1	TYRE0J226A11ML	67	1879312-1	TYSH1J109L50ML	103
1879058-3	TYTRD1D476KTRF	18	1879294-1	TYOHOE227F62MTR	49	1879303-2	TYRE0J336A11ML	67	1879312-2	TYSH2A128H40ML	103
1879058-4	TYTRD1E106KTRF	18	1879294-2	TYOHOE567G2MTR	49	1879303-3	TYRE0J476A11ML	67	1879312-3	TYSH2A128J35ML	103
1879058-5	TYTRD1E156KTRF	18	1879294-3	TYOHOE687G12MTR	49	1879303-4	TYRE0J107A11ML	67	1879312-4	TYSH2A128K25ML	103
1879058-6	TYTRD1E226KTRF	18	1879294-4	TYOHOE108H2MTR	49	1879303-5	TYRE0J157B11ML	67	1879312-5	TYSH2A158H45ML	103
1879058-7	TYTRD1E336KTRF	18	1879294-5	TYOHOE128H10MTR	49	1879303-6	TYRE0J227B11ML	67	1879312-6	TYSH2A158J40ML	103
1879058-8	TYTRD1V106KTRF	18	1879294-6	TYOHOE158H13MTR	49	1879303-7	TYRE0J337B11ML	67	1879312-7	TYSH2A158K30ML	103
1879058-9	TYTRD1V156KTRF	18	1879294-7	TYOHOE157F62MTR	49	1879303-8	TYRE0J337B15ML	67	1879312-8	TYSH2A158L25ML	103
1879062-1	TYTRA0J106MTRF	18	1879294-8	TYOHOE227G2MTR	49	1879303-9	TYRE0J477C11ML	67	1879312-9	TYSH2A188J45ML	103
1879062-2	TYTRA0J156KTRF	18	1879294-9	TYOHOE337G2MTR	49	1879304-1	TYRE1C828G35ML	67	1879313-1	TYSH2E687L35ML	103
1879062-3	TYTRA0J225MTRF	18	1879295-1	TYAV0J476A12ML	79	1879304-2	TYRE1C109G40ML	67	1879313-2	TYSH2E827K45ML	103
1879062-4	TYTRA0J225MTRF	18	1879295-2	TYAV0J107B13ML	79	1879304-3	TYRE1E475A11ML	67	1879313-3	TYSH2E827K50ML	103
1879062-5	TYTRA0J225KTRF	18	1879295-3	TYAV0J227B13ML	79	1879304-4	TYRE1E106A11ML	67	1879313-4	TYSH2E827L40ML	103
1879062-6	TYTRA0J225KTRF	18	1879295-4	TYAV0J337C16ML	79	1879304-5	TYRE1E226A11ML	67	1879313-5	TYSH2E108L45ML	103
1879062-7	TYTRA0J226KTRF	18	1879295-5	TYAV0J477C16ML	79	1879304-6	TYRE1E336A11ML	67	1879313-6	TYSH2E128L45ML	103
1879062-8	TYTRA0J226MTRF	18	1879295-6	TYAV0J108D17ML	79	1879304-7	TYRE1E396A11ML	67	1879313-7	TYSH2V688H25ML	103
1879062-9	TYTRA0J335KTRF	18	1879295-7	TYAV0J228E21ML	79	1879304-8	TYRE1E476A11ML	67	1879313-8	TYSH2V826H25ML	103
1879063-1	TYTRB0G106KTRF	18	1879295-8	TYAV0J338E27ML	79	1879304-9	TYRE1E826B11ML	67	1879313-9	TYSH2V107H30ML	103
1879063-2	TYTRB0G106MTRF	18	1879295-9	TYAV0J478E27ML	79	1879305-1	TYRE1H188G31ML	67	1-1676849-0	TYC0201A279JFT	26
1879063-3	TYTRB0G107KTRF	18	1879296-1	TYAV1J107D17ML	79	1879305-2	TYRE1H228G35ML	67	1-1676849-1	TYC0201A339JFT	26
1879063-4	TYTRB0G107KTRF	18	1879296-2	TYAV1J227E22ML	79	1879305-3	TYRE1J475A11ML	67	1-1676849-2	TYC0201A399JFT	26
1879063-5	TYTRB0G156KTRF	18	1879296-3	TYAV1J337F22ML	79	1879305-4	TYRE1J685A11ML	67	1-1676849-3	TYC0201A479JFT	26
1879063-6	TYTRB0G156MTRF	18	1879296-4	TYAV1J477E27ML	79	1879305-5	TYRE1J106A11ML	67	1-1676849-4	TYC0201A569JFT	26
1879063-7	TYTRB0G226KTRF	18	1879296-5	TYAV1J108F36ML	79	1879305-6	TYRE1J126A11ML	67	1-1676849-5	TYC0201A689JFT	26
1879063-8	TYTRB0G226MTRF	18	1879296-6	TYAV1J228H43ML	79	1879305-7	TYRE1J156B11ML	67	1-1676849-6	TYC0201A829JFT	26
1879063-9	TYTRB0G336KTRF	18	1879296-7	TYAV1J338J52ML	79	1879305-8	TYRE1J226B11ML	67	1-1676849-7	TYC0201A100JFT	26
1879064-1	TYTRC0G107KTRF	18	1879296-8	TYAV1J478J52ML	79	1879305-9	TYRE1J336B11ML	67	1-1676849-8	TYC0201A120JFT	26
1879064-2	TYTRC0G107MTRF	18	1879297-1	TYAH0J107B13ML	85	1879306-1	TYRL2D226D20ML	75	1-1676849-9	TYC0201A150JFT	26
1879064-3	TYTRC0G157KTRF	18	1879297-2	TYAH0J227B13ML	85	1879306-2	TYRL2D336E20ML	75	1-1676850-0	TYC0402A279JFT	26
1879064-4	TYTRC0G157MTRF	18	1879297-3	TYAH0J337C16ML	85	1879306-3	TYRL2D476E20ML	75	1-1676850-1	TYC0402A339JFT	26
1879064-5	TYTRC0G157MTRF	18	1879297-4	TYAH0J477C16ML	85	1879306-4	TYRL2D686E20ML	75	1-1676850-2	TYC0402A399JFT	26
1879064-6	TYTRC0G336KTRF	18	1879297-5	TYAH0J108D17ML	85	1879306-5	TYRL2D686F25ML	75	1-1676850-3	TYC0402A479JFT	26
1879064-7	TYTRC0G336KTRF	18	1879297-6	TYAH0J228E22ML	85	1879306-6	TYRL2D107F25ML	75	1-1676850-4	TYC0402A569JFT	26
1879064-8	TYTRC0G476KTRF	18	1879297-7	TYAH0J338E22ML	85	1879306-7	TYRL2D107G20ML	75	1-1676850-5	TYC0402A689JFT	26
1879064-9	TYTRC0G476MTRF	18	1879297-8	TYAH0J478E27ML	85	1879306-8	TYRL2D157F31ML	75	1-1676850-6	TYC0402A829JFT	26
1879065-1	TYTRD0G107KTRF	18	1879297-9	TYAH1A336A12ML	85	1879306-9	TYRL2D227F35ML	75	1-1676850-7	TYC0402A100JFT	26
1879065-2	TYTRD0G107MTRF	18	1879298-1	TYAH2A225A12ML	85	1879307-1	TYSV1C828H25ML	92	1-1676850-8	TYC0402A150JFT	26
1879065-3	TYTRD0G157KTRF	18	1879298-2	TYAH2A335A12ML	85	1879307-2	TYSV1C109H30ML	92	1-1676850-9	TYC0402A100JFT	26
1879065-4	TYTRD0G157MTRF	18	1879298-3	TYAH2A475B13ML	85	1879307-3	TYSV1C109J30ML	92	1-1676851-0	TYC0402A279JFT	26
1879065-5	TYTRD0G157MTRF	18	1879298-4	TYAH2A106B13							

Tyco Part No.	Brand Part No.	Page No.
1-1676900-4	TYC1206D124ZFT	26
1-1676900-5	TYC1206D154ZFT	26
1-1676900-6	TYC1206D184ZFT	26
1-1676900-7	TYC1206D224ZFT	26
1-1676900-8	TYC1206D274ZFT	26
1-1676900-9	TYC1206D334ZFT	26
1-1676901-0	TYC1206D384ZFT	26
1-1676901-1	TYC1206D434ZFT	26
1-1676901-2	TYC1206D484ZFT	26
1-1676901-3	TYC1206D534ZFT	26
1-1676901-4	TYC1206D584ZFT	26
1-1676901-5	TYC1206D634ZFT	26
1-1676901-6	TYC1206D684ZFT	26
1-1676901-7	TYC1206D734ZFT	26
1-1676901-8	TYC1206D784ZFT	26
1-1676901-9	TYC1206D834ZFT	26
1-1676902-0	TYTSB1A475MTRF	6
1-1676902-1	TYTSC1A156MTRF	6
1-1676902-2	TYTSD1A336MTRF	6
1-1676902-3	TYTSA1C105MTRF	6
1-1676902-4	TYTSB1C335MTRF	6
1-1676902-5	TYTSC1C106MTRF	6
1-1676902-6	TYTSD1C226MTRF	6
1-1676902-7	TYTSA1D684MTRF	6
1-1676902-8	TYTSB1D225MTRF	6
1-1676902-9	TYTSC1D685MTRF	6
1-1676903-0	TYTMB0E686MTRF	9
1-1676903-1	TYTMC0E686MTRF	9
1-1676903-2	TYTMB0E107MTRF	9
1-1676903-3	TYTMC0E107MTRF	9
1-1676903-4	TYTMB0E157MTRF	9
1-1676903-5	TYTMC0E157MTRF	9
1-1676903-6	TYTMD0E157MTRF	9
1-1676903-7	TYTMC0E227MTRF	9
1-1676903-8	TYTMD0E227MTRF	9
1-1676903-9	TYTMD0E337MTRF	9
1-1676904-0	TYTMB1C156MTRF	9
1-1676904-1	TYTMC1C156MTRF	9
1-1676904-2	TYTMB1C226MTRF	9
1-1676904-3	TYTMC1C226MTRF	9
1-1676904-4	TYTMC1C336MTRF	9
1-1676904-5	TYTMD1C336MTRF	9
1-1676904-6	TYTMC1C476MTRF	9
1-1676904-7	TYTMD1C476MTRF	9
1-1676904-8	TYTMD1C686MTRF	9
1-1676904-9	TYTMD1C107MTRF	9
1-1676906-0	TYTTP0G475MTRF	15
1-1676906-1	TYTTP0G685MTRF	15
1-1676906-2	TYTTP0G106MTRF	15
1-1676906-3	TYTTP0G156MTRF	15
1-1676906-4	TYTTP0G226MTRF	15
1-1676906-5	TYTTP0G105MTRF	15
1-1676906-6	TYTTP0J155MTRF	15
1-1676906-7	TYTTP0J225MTRF	15
1-1676906-8	TYTTP0J335MTRF	15
1-1676909-0	TYTRD0J337MTRF	18
1-1676909-1	TYTRB1A106MTRF	18
1-1676909-2	TYTRB1A156MTRF	18
1-1676909-3	TYTRC1A226MTRF	18
1-1676909-4	TYTRC1A336MTRF	18
1-1676909-5	TYTRD1A476MTRF	18
1-1676909-6	TYTRD1A686MTRF	18
1-1676909-7	TYTRD1A107MTRF	18
1-1676909-8	TYTRD1A157MTRF	18
1-1676909-9	TYTRD1A227MTRF	18
1-1879055-0	TYTMA0G335KTRF	9
1-1879055-1	TYTMA0G336KTRF	9
1-1879055-2	TYTMA0G475KTRF	9
1-1879055-3	TYTMA0G476KTRF	9
1-1879055-4	TYTMA0G685KTRF	9
1-1879055-5	TYTMA0J105KTRF	9
1-1879055-6	TYTMA0J106KTRF	9
1-1879055-7	TYTMA0J155KTRF	9
1-1879055-8	TYTMA0J156KTRF	9
1-1879055-9	TYTMA0J225KTRF	9
1-1879056-0	TYTMB1E475KTRF	9
1-1879056-1	TYTMB1H154KTRF	9
1-1879056-2	TYTMB1H224KTRF	9
1-1879056-3	TYTMB1H334KTRF	9
1-1879056-4	TYTMB1H474KTRF	9

Tyco Part No.	Brand Part No.	Page No.
1-1879056-5	TYTMB1H684KTRF	9
1-1879056-6	TYTMB1V105KTRF	9
1-1879056-7	TYTMB1V155KTRF	9
1-1879056-8	TYTMB1V225KTRF	9
1-1879056-9	TYTMB1V335KTRF	9
1-1879057-0	TYTMD1E156KTRF	9
1-1879057-1	TYTMD1E226KTRF	9
1-1879057-2	TYTMD1E336KTRF	9
1-1879057-3	TYTMD1E476KTRF	9
1-1879057-4	TYTMD1H155KTRF	9
1-1879057-5	TYTMD1H225KTRF	9
1-1879057-6	TYTMD1H335KTRF	9
1-1879057-7	TYTMD1H475KTRF	9
1-1879057-8	TYTMD1H685KTRF	9
1-1879057-9	TYTMD1V106KTRF	9
1-1879058-0	TYTRD1H155KTRF	18
1-1879058-1	TYTSA0G335KTRF	6
1-1879058-2	TYTSA0J225KTRF	6
1-1879058-3	TYTSA1A156KTRF	6
1-1879058-4	TYTSA1C105KTRF	6
1-1879058-5	TYTSA1D684KTRF	6
1-1879058-6	TYTSA1E474KTRF	6
1-1879058-7	TYTSA1H104KTRF	6
1-1879058-8	TYTSA1V104KTRF	6
1-1879058-9	TYTSA1V154KTRF	6
1-1879062-0	TYTRA0J335MTRF	18
1-1879062-1	TYTRA0J475KTRF	18
1-1879062-2	TYTRA0J55MTRF	18
1-1879062-3	TYTRA0J685KTRF	18
1-1879062-4	TYTRA0J685MTRF	18
1-1879062-5	TYTRA0J106KTRF	18
1-1879062-6	TYTRA1A106MTRF	18
1-1879062-7	TYTRA1A155KTRF	18
1-1879062-8	TYTRA1A155MTRF	18
1-1879062-9	TYTRA1A156KTRF	18
1-1879063-0	TYTRB0G336MTRF	18
1-1879063-1	TYTRB0G476KTRF	18
1-1879063-2	TYTRB0G476MTRF	18
1-1879063-3	TYTRB0G686KTRF	18
1-1879063-4	TYTRB0G686MTRF	18
1-1879063-5	TYTRB0J336KTRF	18
1-1879063-6	TYTRB0J336MTRF	18
1-1879063-7	TYTRB0J476KTRF	18
1-1879063-8	TYTRB0J476MTRF	18
1-1879063-9	TYTRB0J685KTRF	18
1-1879064-0	TYTRC0G686MTRF	18
1-1879064-1	TYTRC0J107KTRF	18
1-1879064-2	TYTRC0J107MTRF	18
1-1879064-3	TYTRC0J157KTRF	18
1-1879064-4	TYTRC0J157MTRF	18
1-1879064-5	TYTRC0J226KTRF	18
1-1879064-6	TYTRC0J226MTRF	18
1-1879064-7	TYTRC0J686KTRF	18
1-1879064-8	TYTRC0J686MTRF	18
1-1879064-9	TYTRC1A107KTRF	18
1-1879065-0	TYTRD0G477MTRF	18
1-1879065-1	TYTRD0G686KTRF	18
1-1879065-2	TYTRD0G686MTRF	18
1-1879065-3	TYTRD0J476KTRF	18
1-1879065-4	TYTRD0J476MTRF	18
1-1879065-5	TYTRD1A336KTRF	18
1-1879065-6	TYTRD1A336MTRF	18
1-1879065-7	TYTRD1C226KTRF	18
1-1879065-8	TYTRD1C226MTRF	18
1-1879065-9	TYTRD1D156KTRF	18
1-1879290-0	TYEV0J477G10MTR	36
1-1879290-1	TYEV0J108G10MTR	36
1-1879290-2	TYEV0J108H10MTR	36
1-1879290-3	TYEV1A226D55MTR	36
1-1879290-4	TYEV1A336D55MTR	36
1-1879290-5	TYEV1A336E55MTR	36
1-1879290-6	TYEV1A476F55MTR	36
1-1879290-7	TYEV1A107F55MTR	36
1-1879290-8	TYEV1A227F80MTR	36
1-1879291-0	TYEH1A476F55MTR	40
1-1879291-1	TYEH1A107F55MTR	40
1-1879291-2	TYEH1A107G68MTR	40
1-1879291-3	TYEH1A227F80MTR	40
1-1879291-4	TYEH1A227G10MTR	40
1-1879291-5	TYEH1A337G10MTR	40

Tyco Part No.	Brand Part No.	Page No.
1-1879291-6	TYEH1A477G10MTR	40
1-1879291-7	TYEH1A477H10MTR	40
1-1879291-8	TYEH1A108H10MTR	40
1-1879291-9	TYEH1C106D55MTR	40
1-1879292-0	TYEL1A336E60MTR	46
1-1879292-1	TYEL1A476F60MTR	46
1-1879292-2	TYEL1A107F80MTR	46
1-1879292-3	TYEL1A227G10MTR	46
1-1879292-4	TYEL1A337H10MTR	46
1-1879292-5	TYEL1A477H10MTR	46
1-1879292-6	TYEL1C106D60MTR	46
1-1879292-7	TYEL1C226E60MTR	46
1-1879292-8	TYEL1C336F60MTR	46
1-1879292-9	TYEL1C476F60MTR	46
1-1879293-0	TYEE1C106D55MTR	44
1-1879293-1	TYEE1C226E55MTR	44
1-1879293-2	TYEE1C336F55MTR	44
1-1879293-3	TYEE1C476F55MTR	44
1-1879293-4	TYEE1C107F55MTR	44
1-1879293-5	TYEE1C157F80MTR	44
1-1879293-6	TYEE1E106E55MTR	44
1-1879293-7	TYEE1E226F55MTR	44
1-1879293-8	TYEE1E336F55MTR	44
1-1879293-9	TYEE1E476F55MTR	44
1-1879294-0	TYOH0G477H82MTR	49
1-1879294-1	TYOH0G567G12MTR	49
1-1879294-2	TYOH0G687H82MTR	49
1-1879294-3	TYOH0G827H10MTR	49
1-1879294-4	TYOH0G128H13MTR	49
1-1879294-5	TYOH0J826F62MTR	49
1-1879294-6	TYOH0J107F62MTR	49
1-1879294-7	TYOH0J127F72MTR	49
1-1879294-8	TYOH0J157F72MTR	49
1-1879294-9	TYOH0J157G72MTR	49
1-1879295-0	TYAV0J688F28ML	79
1-1879295-1	TYAV0J109F36ML	79
1-1879295-2	TYAV0J229H43ML	79
1-1879295-3	TYAV1A336A12ML	79
1-1879295-4	TYAV1A476A12ML	79
1-1879295-5	TYAV1A107B13ML	79
1-1879295-6	TYAV1A227C13ML	79
1-1879295-7	TYAV1A337C16ML	79
1-1879295-8	TYAV1A477C16ML	79
1-1879295-9	TYAV1A108D17ML	79
1-1879296-0	TYAV2A104A12ML	79
1-1879296-1	TYAV2A224A12ML	79
1-1879296-2	TYAV2A334A12ML	79
1-1879296-3	TYAV2A474A12ML	79
1-1879296-4	TYAV2A105A12ML	79
1-1879296-5	TYAV2A225A12ML	79
1-1879296-6	TYAV2A335A12ML	79
1-1879296-7	TYAV2A475B13ML	79
1-1879296-8	TYAV2A106B13ML	79
1-1879296-9	TYAV2A226C16ML	79
1-1879297-0	TYAH1A476A12ML	85
1-1879297-1	TYAH1A107B13ML	85
1-1879297-2	TYAH1A227C13ML	85
1-1879297-3	TYAH1A337C16ML	85
1-1879297-4	TYAH1A477C16ML	85
1-1879297-5	TYAH1A108D17ML	85
1-1879297-6	TYAH1A228E22ML	85
1-1879297-7	TYAH1A338E27ML	85
1-1879297-8	TYAH1A478F28ML	85
1-1879297-9	TYAH1C106A12ML	85
1-1879298-0	TYAH2A337F33ML	85
1-1879298-1	TYAH2A477F36ML	85
1-1879298-2	TYAH2A108G42ML	85
1-1879298-3	TYAH2A228J52ML	85
1-1879298-4	TYAH2C105B13ML	85
1-1879298-5	TYAH2C225B13ML	85
1-1879298-6	TYAH2C335C16ML	85
1-1879298-7	TYAH2C475C16ML	85
1-1879298-8	TYAH2C106D17ML	85
1-1879298-9	TYAH2C226D21ML	85
1-1879299-0	TYRV0J478E20ML	53
1-1879299-1	TYRV0J688E25ML	53
1-1879299-2	TYRV0J109F25ML	53
1-1879299-3	TYRV0J229G40ML	53
1-1879299-4	TYRV0J229H40ML	53
1-1879299-5	TYRV1A226A11ML	53
1-1879299-6	TYRV1A336A11ML	53

Tyco Part No.	Brand Part No.	Page No.
1-1879299-7	TYRV1A476A11ML	53
1-1879299-8	TYRV1A107A11ML	53
1-1879299-9	TYRV1A227B11ML	53
1-1879300-0	TYRV2A224A11ML	53
1-1879300-1	TYRV2A334A11ML	53
1-1879300-2	TYRV2A474A11ML	53
1-1879300-3	TYRV2A105A11ML	53
1-1879300-4	TYRV2A225A11ML	53
1-1879300-5	TYRV2A335A11ML	53
1-1879300-6	TYRV2A475A11ML	53
1-1879300-7	TYRV2A106B11ML	53
1-1879300-8	TYRV2A226B11ML	53
1-1879300-9	TYRV2A336C11ML	53
1-1879301-0	TYRH0J477E20ML	60
1-1879301-1	TYRH0J108E25ML	60
1-1879301-2	TYRH0J109F25ML	60
1-1879301-3	TYRH0J229G40ML	60
1-1879301-4	TYRH1A226A11ML	60
1-1879301-5	TYRH1A336A11ML	60
1-1879301-6	TYRH1A476A11ML	60
1-1879301-7	TYRH1A107A11ML	60
1-1879301-8	TYRH1A227B11ML	60
1-1879301-9	TYRH1A337B11ML	60
1-1879302-0	TYRH2A475A11ML	60
1-1879302-1	TYRH2A106B11ML	60
1-1879302-2	TYRH2A226B11ML	60
1-1879302-3	TYRH2A336C11ML	60
1-1879302-4	TYRH2A476D12ML	60
1-1879302-5	TYRH2A107D20ML	60
1-1879302-6	TYRH2A	

Tyco Electronics to Brand Part Number Index

Tyco Part No.	Brand Part No.	Page No.
1-1879307-8	TYSV1E28J25ML	92
1-1879307-9	TYSV1E109H35ML	92
1-1879308-0	TYSV2A188K25ML	92
1-1879308-1	TYSV2A228H45ML	92
1-1879308-2	TYSV2A228L40ML	92
1-1879308-3	TYSV2A228K30ML	92
1-1879308-4	TYSV2A228L25ML	92
1-1879308-5	TYSV2A278J45ML	92
1-1879308-6	TYSV2A278K35ML	92
1-1879308-7	TYSV2A278L30ML	92
1-1879308-8	TYSV2A338J50ML	92
1-1879308-9	TYSV2A338K40ML	92
1-1879309-0	TYSV2E397J45ML	92
1-1879309-1	TYSV2E397J35ML	92
1-1879309-2	TYSV2E397K25ML	92
1-1879309-3	TYSV2E477H40ML	92
1-1879309-4	TYSV2E477H45ML	92
1-1879309-5	TYSV2E477J35ML	92
1-1879309-6	TYSV2E477K30ML	92
1-1879309-7	TYSV2E567H50ML	92
1-1879309-8	TYSV2E567J40ML	92
1-1879309-9	TYSV2E567J45ML	92
1-1879310-0	TYSV2G397L35ML	92
1-1879310-1	TYSV2G397L40ML	92
1-1879310-2	TYSV2G477K40ML	92
1-1879310-3	TYSV2G477L40ML	92
1-1879310-4	TYSV2G477L45ML	92
1-1879310-5	TYSV2G567L45ML	92
1-1879310-6	TYSV2G567L50ML	92
1-1879310-7	TYSV2G687L50ML	92
1-1879310-8	TYSV2W566H25ML	92
1-1879310-9	TYSV2W686H25ML	92
1-1879311-0	TYSH1C189H45ML	103
1-1879311-1	TYSH1C189A40ML	103
1-1879311-2	TYSH1C189K30ML	103
1-1879311-3	TYSH1C189L25ML	103
1-1879311-4	TYSH1C229J45ML	103
1-1879311-5	TYSH1C229K35ML	103
1-1879311-6	TYSH1E478H25ML	103
1-1879311-7	TYSH1E568H25ML	103
1-1879311-8	TYSH1E688H30ML	103
1-1879311-9	TYSH1E688J25ML	103
1-1879312-0	TYSH2A188K35ML	103
1-1879312-1	TYSH2A228J50ML	103
1-1879312-2	TYSH2A228K40ML	103
1-1879312-3	TYSH2A228L30ML	103
1-1879312-4	TYSH2A278K45ML	103
1-1879312-5	TYSH2A278L35ML	103
1-1879312-6	TYSH2A338K50ML	103
1-1879312-7	TYSH2A338L40ML	103
1-1879312-8	TYSH2A398L45ML	103
1-1879312-9	TYSH2A478J50ML	103
1-1879313-0	TYSH2V107J25ML	103
1-1879313-1	TYSH2V127H35ML	103
1-1879313-2	TYSH2V157H40ML	103
1-1879313-3	TYSH2V157J30ML	103
1-1879313-4	TYSH2V157K25ML	103
1-1879313-5	TYSH2V187J35ML	103
1-1879313-6	TYSH2V187K30ML	103
1-1879313-7	TYSH2V227J40ML	103
1-1879313-8	TYSH2V227K30ML	103
1-1879313-9	TYSH2V227L25ML	103
2-1676849-0	TYC0201A180JFT	26
2-1676849-1	TYC0201A220JFT	26
2-1676849-2	TYC0201A270JFT	26
2-1676849-3	TYC0201A330JFT	26
2-1676849-4	TYC0201A390JFT	26
2-1676849-5	TYC0201A470JFT	26
2-1676849-6	TYC0201A560JFT	26
2-1676849-7	TYC0201A680JFT	26
2-1676849-8	TYC0201A820JFT	26
2-1676849-9	TYC0201A101JFT	26
2-1676850-0	TYC0402A180JFT	26
2-1676850-1	TYC0402A220JFT	26
2-1676850-2	TYC0402A270JFT	26
2-1676850-3	TYC0402A330JFT	26
2-1676850-4	TYC0402A390JFT	26
2-1676850-5	TYC0402A470JFT	26
2-1676850-6	TYC0402A560JFT	26
2-1676850-7	TYC0402A680JFT	26
2-1676850-8	TYC0402A820JFT	26

Tyco Part No.	Brand Part No.	Page No.
2-1676850-9	TYC0402A101JFT	26
2-1676851-0	TYC0402A180JGT	26
2-1676851-1	TYC0402A220JGT	26
2-1676851-2	TYC0402A270JGT	26
2-1676851-3	TYC0402A330JGT	26
2-1676851-4	TYC0402A390JGT	26
2-1676851-5	TYC0402A470JGT	26
2-1676851-6	TYC0402A560JGT	26
2-1676851-7	TYC0402A680JGT	26
2-1676851-8	TYC0402A820JGT	26
2-1676851-9	TYC0402A101JGT	26
2-1676853-0	TYC0603A180JFT	26
2-1676853-1	TYC0603A220JFT	26
2-1676853-2	TYC0603A270JFT	26
2-1676853-3	TYC0603A330JFT	26
2-1676853-4	TYC0603A390JFT	26
2-1676853-5	TYC0603A470JFT	26
2-1676853-6	TYC0603A560JFT	26
2-1676853-7	TYC0603A680JFT	26
2-1676853-8	TYC0603A820JFT	26
2-1676853-9	TYC0603A101JFT	26
2-1676854-0	TYC0603A180JGT	26
2-1676854-1	TYC0603A220JGT	26
2-1676854-2	TYC0603A270JGT	26
2-1676854-3	TYC0603A330JGT	26
2-1676854-4	TYC0603A390JGT	26
2-1676854-5	TYC0603A470JGT	26
2-1676854-6	TYC0603A560JGT	26
2-1676854-7	TYC0603A680JGT	26
2-1676854-8	TYC0603A820JGT	26
2-1676854-9	TYC0603A101JGT	26
2-1676855-0	TYC0603A180JHT	26
2-1676855-1	TYC0603A220JHT	26
2-1676855-2	TYC0603A270JHT	26
2-1676855-3	TYC0603A330JHT	26
2-1676855-4	TYC0603A390JHT	26
2-1676855-5	TYC0603A470JHT	26
2-1676855-6	TYC0603A560JHT	26
2-1676855-7	TYC0603A680JHT	26
2-1676855-8	TYC0603A820JHT	26
2-1676855-9	TYC0603A101JHT	26
2-1676856-0	TYC0805A180JFT	26
2-1676856-1	TYC0805A220JFT	26
2-1676856-2	TYC0805A270JFT	26
2-1676856-3	TYC0805A330JFT	26
2-1676856-4	TYC0805A390JFT	26
2-1676856-5	TYC0805A470JFT	26
2-1676856-6	TYC0805A560JFT	26
2-1676856-7	TYC0805A680JFT	26
2-1676856-8	TYC0805A820JFT	26
2-1676856-9	TYC0805A101JFT	26
2-1676857-0	TYC0805A180JGT	26
2-1676857-1	TYC0805A220JGT	26
2-1676857-2	TYC0805A270JGT	26
2-1676857-3	TYC0805A330JGT	26
2-1676857-4	TYC0805A390JGT	26
2-1676857-5	TYC0805A470JGT	26
2-1676857-6	TYC0805A560JGT	26
2-1676857-7	TYC0805A680JGT	26
2-1676857-8	TYC0805A820JGT	26
2-1676857-9	TYC0805A101JGT	26
2-1676858-0	TYC0805A180JHT	26
2-1676858-1	TYC0805A220JHT	26
2-1676858-2	TYC0805A270JHT	26
2-1676858-3	TYC0805A330JHT	26
2-1676858-4	TYC0805A390JHT	26
2-1676858-5	TYC0805A470JHT	26
2-1676858-6	TYC0805A560JHT	26
2-1676858-7	TYC0805A680JHT	26
2-1676858-8	TYC0805A820JHT	26
2-1676858-9	TYC0805A101JHT	26
2-1676859-0	TYC0805A180JJT	26
2-1676859-1	TYC0805A220JJT	26
2-1676859-2	TYC0805A270JJT	26
2-1676859-3	TYC0805A330JJT	26
2-1676859-4	TYC0805A390JJT	26
2-1676859-5	TYC0805A470JJT	26
2-1676859-6	TYC0805A560JJT	26
2-1676859-7	TYC0805A680JJT	26
2-1676859-8	TYC0805A820JJT	26
2-1676859-9	TYC0805A101JJT	26

Tyco Part No.	Brand Part No.	Page No.
2-1676860-0	TYC1206A180JGT	26
2-1676860-1	TYC1206A220JGT	26
2-1676860-2	TYC1206A270JGT	26
2-1676860-3	TYC1206A330JGT	26
2-1676860-4	TYC1206A390JGT	26
2-1676860-5	TYC1206A470JGT	26
2-1676860-6	TYC1206A560JGT	26
2-1676860-7	TYC1206A680JGT	26
2-1676860-8	TYC1206A820JGT	26
2-1676860-9	TYC1206A101JGT	26
2-1676861-0	TYC1206A180JHT	26
2-1676861-1	TYC1206A220JHT	26
2-1676861-2	TYC1206A270JHT	26
2-1676861-3	TYC1206A330JHT	26
2-1676861-4	TYC1206A390JHT	26
2-1676861-5	TYC1206A470JHT	26
2-1676861-6	TYC1206A560JHT	26
2-1676861-7	TYC1206A680JHT	26
2-1676861-8	TYC1206A820JHT	26
2-1676861-9	TYC1206A101JHT	26
2-1676862-0	TYC1206A180JJT	26
2-1676862-1	TYC1206A220JJT	26
2-1676862-2	TYC1206A270JJT	26
2-1676862-3	TYC1206A330JJT	26
2-1676862-4	TYC1206A390JJT	26
2-1676862-5	TYC1206A470JJT	26
2-1676862-6	TYC1206A560JJT	26
2-1676862-7	TYC1206A680JJT	26
2-1676862-8	TYC1206A820JJT	26
2-1676862-9	TYC1206A101JJT	26
2-1676863-0	TYC1206A180JLT	26
2-1676863-1	TYC1206A220JLT	26
2-1676863-2	TYC1206A270JLT	26
2-1676863-3	TYC1206A330JLT	26
2-1676863-4	TYC1206A390JLT	26
2-1676863-5	TYC1206A470JLT	26
2-1676863-6	TYC1206A560JLT	26
2-1676863-7	TYC1206A680JLT	26
2-1676863-8	TYC1206A820JLT	26
2-1676863-9	TYC1206A101JLT	26
2-1676864-0	TYC0402B392KDT	26
2-1676864-1	TYC0402B472KDT	26
2-1676864-2	TYC0402B562KDT	26
2-1676864-3	TYC0402B682KDT	26
2-1676864-4	TYC0402B822KDT	26
2-1676864-5	TYC0402B103KDT	26
2-1676864-6	TYC0402B123KDT	26
2-1676864-7	TYC0402B153KDT	26
2-1676864-8	TYC0402B183KDT	26
2-1676864-9	TYC0402B223KDT	26
2-1676865-0	TYC0402B392KET	26
2-1676865-1	TYC0402B472KET	26
2-1676865-2	TYC0402B562KET	26
2-1676865-3	TYC0402B682KET	26
2-1676865-4	TYC0402B822KET	26
2-1676865-5	TYC0402B103KET	26
2-1676865-6	TYC0402B123KET	26
2-1676865-7	TYC0402B153KET	26
2-1676865-8	TYC0402B183KET	26
2-1676865-9	TYC0402B223KET	26
2-1676866-0	TYC0402B392KFT	26
2-1676866-1	TYC0402B472KFT	26
2-1676866-2	TYC0402B562KFT	26
2-1676866-3	TYC0402B682KFT	26
2-1676866-4	TYC0402B822KFT	26
2-1676866-5	TYC0402B103KFT	26
2-1676866-6	TYC0402B123KFT	26
2-1676866-7	TYC0402B153KFT	26
2-1676866-8	TYC0402B183KFT	26
2-1676866-9	TYC0402B223KFT	26
2-1676867-0	TYC0603B472KFT	26
2-1676867-1	TYC0603B562KFT	26
2-1676867-2	TYC0603B682KFT	26
2-1676867-3	TYC0603B822KFT	26
2-1676867-4	TYC0603B103KFT	26
2-1676867-5	TYC0603B123KFT	26
2-1676867-6	TYC0603B153KFT	26
2-1676867-7	TYC0603B183KFT	26
2-1676867-8	TYC0603B223KFT	26
2-1676867-9	TYC0603B392KFT	26

Tyco Part No.	Brand Part No.	Page No.
2-1676871-1	TYC0603B472KGT	26
2-1676871-2	TYC0603B562KGT	26
2-1676871-3	TYC0603B682KGT	26
2-1676871-4	TYC0603B822KGT	26
2-1676871-5	TYC0603B103KGT	26
2-1676871-6	TYC0603B123KGT	26
2-1676871-7	TYC0603B153KGT	26
2-1676871-8	TYC0603B183KGT	26
2-1676871-9	TYC0603B223KGT	26
2-1676872-0	TYC0603B392KHT	26
2-1676872-1	TYC0603B472KHT	26
2-1676872-2	TYC0603B562KHT	26
2-1676872-3	TYC0603B682KHT	26
2-1676872-4	TYC0603B822KHT	26
2-1676872-5	TYC0603B103KHT	26
2-1676872-6	TYC0603B123KHT	26
2-1676872-7	TYC0603B153KHT	26
2-1676872-8	TYC0603B183KHT	26
2-1676872-9	TYC0603B223KHT	26
2-1676873-0	TYC0805B392KFT	26
2-1676873-1	TYC0805B472KFT	26
2-1676873-2	TYC0805B562KFT	26
2-1676873-3	TYC0805B682KFT	26
2-1		

Tyco Part No.	Brand Part No.	Page No.
2-1676884-9	TYC1206B223KJP	26
2-1676885-0	TYC1206B392KLP	26
2-1676885-1	TYC1206B472KLP	26
2-1676885-2	TYC1206B562KLP	26
2-1676885-3	TYC1206B682KLP	26
2-1676885-4	TYC1206B822KLP	26
2-1676885-5	TYC1206B103KLP	26
2-1676888-0	TYC0603C394ZDT	26
2-1676889-0	TYC0603C474ZDT	26
2-1676892-0	TYC0603D394ZET	26
2-1676892-1	TYC0603D474ZET	26
2-1676892-2	TYC0603D564ZET	26
2-1676892-3	TYC0603D684ZET	26
2-1676892-4	TYC0603D824ZET	26
2-1676892-5	TYC0603D105ZET	26
2-1676895-0	TYC0805D394ZET	26
2-1676895-1	TYC0805D474ZET	26
2-1676895-2	TYC0805D564ZET	26
2-1676895-3	TYC0805D684ZET	26
2-1676895-4	TYC0805D824ZET	26
2-1676895-5	TYC0805D105ZET	26
2-1676895-6	TYC0805D125ZET	26
2-1676895-7	TYC0805D155ZET	26
2-1676895-8	TYC0805D185ZET	26
2-1676895-9	TYC0805D225ZET	26
2-1676896-0	TYC0805D247ZFP	26
2-1676896-1	TYC0805D282ZFP	26
2-1676896-2	TYC0805D327ZFP	26
2-1676896-3	TYC0805D372ZFP	26
2-1676896-4	TYC0805D417ZFP	26
2-1676896-5	TYC0805D462ZFP	26
2-1676896-6	TYC0805D507ZFP	26
2-1676896-7	TYC0805D552ZFP	26
2-1676896-8	TYC0805D597ZFP	26
2-1676896-9	TYC0805D642ZFP	26
2-1676897-0	TYC1206D1474ZFT	26
2-1676897-1	TYC1206D182ZFT	26
2-1676897-2	TYC1206D227ZFT	26
2-1676897-3	TYC1206D272ZFT	26
2-1676897-4	TYC1206D317ZFT	26
2-1676897-5	TYC1206D362ZFT	26
2-1676897-6	TYC1206D407ZFT	26
2-1676897-7	TYC1206D452ZFT	26
2-1676897-8	TYC1206D497ZFT	26
2-1676897-9	TYC1206D542ZFT	26
2-1676900-0	TYC1206D587ZFT	26
2-1676900-1	TYC1206D632ZFT	26
2-1676900-2	TYC1206D677ZFT	26
2-1676900-3	TYC1206D722ZFT	26
2-1676900-4	TYC1206D767ZFT	26
2-1676900-5	TYC1206D812ZFT	26
2-1676900-6	TYC1206D857ZFT	26
2-1676900-7	TYC1206D902ZFT	26
2-1676900-8	TYC1206D947ZFT	26
2-1676900-9	TYC1206D992ZFT	26
2-1676901-0	TYC1206D1037ZFT	26
2-1676901-1	TYC1206D1082ZFT	26
2-1676901-2	TYC1206D1127ZFT	26
2-1676901-3	TYC1206D1172ZFT	26
2-1676901-4	TYC1206D1217ZFT	26
2-1676901-5	TYC1206D1262ZFT	26
2-1676901-6	TYC1206D1307ZFT	26
2-1676901-7	TYC1206D1352ZFT	26
2-1676901-8	TYC1206D1397ZFT	26
2-1676901-9	TYC1206D1442ZFT	26
2-1676902-0	TYC1206D1487ZFT	26
2-1676902-1	TYC1206D1532ZFT	26
2-1676902-2	TYC1206D1577ZFT	26
2-1676902-3	TYC1206D1622ZFT	26
2-1676902-4	TYC1206D1667ZFT	26
2-1676902-5	TYC1206D1712ZFT	26
2-1676902-6	TYC1206D1757ZFT	26
2-1676902-7	TYC1206D1802ZFT	26
2-1676902-8	TYC1206D1847ZFT	26
2-1676902-9	TYC1206D1892ZFT	26
2-1676903-0	TYC1206D1937ZFT	26
2-1676903-1	TYC1206D1982ZFT	26
2-1676903-2	TYC1206D2027ZFT	26
2-1676903-3	TYC1206D2072ZFT	26
2-1676903-4	TYC1206D2117ZFT	26
2-1676903-5	TYC1206D2162ZFT	26
2-1676903-6	TYC1206D2207ZFT	26
2-1676903-7	TYC1206D2252ZFT	26
2-1676903-8	TYC1206D2297ZFT	26
2-1676903-9	TYC1206D2342ZFT	26
2-1676904-0	TYC1206D2387ZFT	26
2-1676904-1	TYC1206D2432ZFT	26
2-1676904-2	TYC1206D2477ZFT	26
2-1676904-3	TYC1206D2522ZFT	26
2-1676904-4	TYC1206D2567ZFT	26
2-1676904-5	TYC1206D2612ZFT	26
2-1676904-6	TYC1206D2657ZFT	26
2-1676904-7	TYC1206D2702ZFT	26
2-1676904-8	TYC1206D2747ZFT	26
2-1676904-9	TYC1206D2792ZFT	26

Tyco Part No.	Brand Part No.	Page No.
2-1676904-9	TYTMC1D106MTRF	9
2-1676906-0	TYTTP0J475MTRF	15
2-1676906-1	TYTTP0J685MTRF	15
2-1676906-2	TYTTP0J106MTRF	15
2-1676906-3	TYTTP1A684MTRF	15
2-1676906-4	TYTTP1A105MTRF	15
2-1676906-5	TYTTP1A155MTRF	15
2-1676906-6	TYTTP1A225MTRF	15
2-1676906-7	TYTTP1A335MTRF	15
2-1676906-8	TYTTP1A475MTRF	15
2-1676906-9	TYTTP1C474MTRF	15
2-1676909-0	TYTRB1C106MTRF	18
2-1676909-1	TYTRC1C156MTRF	18
2-1676909-2	TYTRC1C226MTRF	18
2-1676909-3	TYTRD1C336MTRF	18
2-1676909-4	TYTRD1C476MTRF	18
2-1676909-5	TYTRD1C686MTRF	18
2-1676909-6	TYTRD1C107MTRF	18
2-1676909-7	TYTRC1D106MTRF	18
2-1676909-8	TYTRC1D156MTRF	18
2-1676909-9	TYTRD1D226MTRF	18
2-1879055-0	TYTMA0J226KTRF	9
2-1879055-1	TYTMA0J335KTRF	9
2-1879055-2	TYTMA0J336KTRF	9
2-1879055-3	TYTMA0J475KTRF	9
2-1879055-4	TYTMA0J685KTRF	9
2-1879055-5	TYTMA1A105KTRF	9
2-1879055-6	TYTMA1A106KTRF	9
2-1879055-7	TYTMA1A155KTRF	9
2-1879055-8	TYTMA1A156KTRF	9
2-1879055-9	TYTMA1A225KTRF	9
2-1879056-0	TYTMB1V474KTRF	9
2-1879056-1	TYTMC0E107KTRF	9
2-1879056-2	TYTMC0E157KTRF	9
2-1879056-3	TYTMC0E227KTRF	9
2-1879056-4	TYTMC0E686KTRF	9
2-1879056-5	TYTMC0G107KTRF	9
2-1879056-6	TYTMC0G157KTRF	9
2-1879056-7	TYTMC0G227KTRF	9
2-1879056-8	TYTMC0G336KTRF	9
2-1879056-9	TYTMC0G476KTRF	9
2-1879057-0	TYTMD1V156KTRF	9
2-1879057-1	TYTMD1V226KTRF	9
2-1879057-2	TYTMD1V335KTRF	9
2-1879057-3	TYTMD1V475KTRF	9
2-1879057-4	TYTMD1V685KTRF	9
2-1879057-5	TYTTP0E106KTRF	15
2-1879057-6	TYTTP0E156KTRF	15
2-1879057-7	TYTTP0E225KTRF	15
2-1879057-8	TYTTP0E226KTRF	15
2-1879057-9	TYTTP0E335KTRF	15
2-1879058-0	TYTSA1V224KTRF	6
2-1879058-1	TYTSA1V334KTRF	6
2-1879058-2	TYTSB0G106KTRF	6
2-1879058-3	TYTSB0G685KTRF	6
2-1879058-4	TYTSB1A475MTRF	6
2-1879058-5	TYTSB1C335KTRF	6
2-1879058-6	TYTSB1D225KTRF	6
2-1879058-7	TYTSB1E155KTRF	6
2-1879058-8	TYTSB1H154KTRF	6
2-1879058-9	TYTSB1H224KTRF	6
2-1879062-0	TYTRA1A156MTRF	18
2-1879062-1	TYTRA1A225KTRF	18
2-1879062-2	TYTRA1A225MTRF	18
2-1879062-3	TYTRA1A335KTRF	18
2-1879062-4	TYTRA1A335MTRF	18
2-1879062-5	TYTRA1A475KTRF	18
2-1879062-6	TYTRA1A475MTRF	18
2-1879062-7	TYTRA1A685KTRF	18
2-1879062-8	TYTRA1A685MTRF	18
2-1879062-9	TYTRA1C105KTRF	18
2-1879063-0	TYTRB0G685MTRF	18
2-1879063-1	TYTRB1A226KTRF	18
2-1879063-2	TYTRB1A226MTRF	18
2-1879063-3	TYTRB1A336KTRF	18
2-1879063-4	TYTRB1A336MTRF	18
2-1879063-5	TYTRB1A475KTRF	18
2-1879063-6	TYTRB1A475MTRF	18
2-1879063-7	TYTRB1A685KTRF	18
2-1879063-8	TYTRB1A685MTRF	18
2-1879063-9	TYTRB1C156KTRF	18

Tyco Part No.	Brand Part No.	Page No.
2-1879064-0	TYTRC1A107MTRF	18
2-1879064-1	TYTRC1A156KTRF	18
2-1879064-2	TYTRC1A156MTRF	18
2-1879064-3	TYTRC1A476KTRF	18
2-1879064-4	TYTRC1A476MTRF	18
2-1879064-5	TYTRC1A686KTRF	18
2-1879064-6	TYTRC1C106KTRF	18
2-1879064-7	TYTRC1C106MTRF	18
2-1879064-8	TYTRC1C336KTRF	18
2-1879065-0	TYTRD1D156MTRF	18
2-1879065-1	TYTRD1H155KTRF	18
2-1879065-2	TYTRD1H155MTRF	18
2-1879065-3	TYTRD1H225KTRF	18
2-1879065-4	TYTRD1H225MTRF	18
2-1879065-5	TYTRD1H335KTRF	18
2-1879065-6	TYTRD1H335MTRF	18
2-1879065-7	TYTRD1H475KTRF	18
2-1879065-8	TYTRD1H475MTRF	18
2-1879065-9	TYTRD1V475KTRF	18
2-1879290-0	TYEV1A227G68MTR	36
2-1879290-1	TYEV1A337G10MTR	36
2-1879290-2	TYEV1A477G10MTR	36
2-1879290-3	TYEV1A477H10MTR	36
2-1879290-4	TYEV1A108H10MTR	36
2-1879290-5	TYEV1C106D55MTR	36
2-1879290-6	TYEV1C226D55MTR	36
2-1879290-7	TYEV1C226E55MTR	36
2-1879290-8	TYEV1C336E55MTR	36
2-1879290-9	TYEV1C476E55MTR	36
2-1879291-0	TYEH1C226E55MTR	40
2-1879291-1	TYEH1C336F55MTR	40
2-1879291-2	TYEH1C476F55MTR	40
2-1879291-3	TYEH1C107F55MTR	40
2-1879291-4	TYEH1C227F80MTR	40
2-1879291-5	TYEH1C227H10MTR	40
2-1879291-6	TYEH1C337G10MTR	40
2-1879291-7	TYEH1C337H10MTR	40
2-1879291-8	TYEH1C477G10MTR	40
2-1879291-9	TYEH1C477H10MTR	40
2-1879292-0	TYEL1C107F80MTR	46
2-1879292-1	TYEL1C227H10MTR	46
2-1879292-2	TYEL1C337H10MTR	46
2-1879292-3	TYEL1C477H10MTR	46
2-1879292-4	TYEL1E106E60MTR	46
2-1879292-5	TYEL1E226F60MTR	46
2-1879292-6	TYEL1E336F60MTR	46
2-1879292-7	TYEL1E476F80MTR	46
2-1879292-8	TYEL1E107G10MTR	46
2-1879292-9	TYEL1E227H10MTR	46
2-1879293-0	TYEE1E107F80MTR	44
2-1879293-1	TYEE1V475D55MTR	44
2-1879293-2	TYEE1V106E55MTR	44
2-1879293-3	TYEE1V226F55MTR	44
2-1879293-4	TYEE1V336F55MTR	44
2-1879293-5	TYEE1V476F80MTR	44
2-1879294-0	TYOH0J227F72MTR	49
2-1879294-1	TYOH0J227G72MTR	49
2-1879294-2	TYOH0J337H82MTR	49
2-1879294-3	TYOH0J477G12MTR	49
2-1879294-4	TYOH0J477H82MTR	49
2-1879294-5	TYOH0J567H10MTR	49
2-1879294-6	TYOH0J827H13MTR	49
2-1879294-7	TYOH1A566F62MTR	49
2-1879294-8	TYOH1A157G72MTR	49
2-1879294-9	TYOH1A337G12MTR	49
2-1879295-0	TYAV1A228E22ML	79
2-1879295-1	TYAV1A338E27ML	79
2-1879295-2	TYAV1A478F28ML	79
2-1879295-3	TYAV1A688F33ML	79
2-1879295-4	TYAV1A109G36ML	79
2-1879295-5	TYAV1C226A12ML	79
2-1879295-6	TYAV1C336A12ML	79
2-1879295-7	TYAV1C476B13ML	79
2-1879295-8	TYAV1C107B13ML	79
2-1879295-9	TYAV1C227C13ML	79
2-1879296-0	TYAV2A336D17ML	79
2-1879296-1	TYAV2A476D21ML	79
2-1879296-2	TYAV2A107E22ML	79
2-1879296-3	TYAV2A227F28ML	79
2-1879296-4	TYAV2A337F33ML	79

Tyco Part No.	Brand Part No.	Page No.
2-1879296-5	TYAV2A477F36ML	79
2-1879296-6	TYAV2A108G42ML	79
2-1879296-7	TYAV2A228J52ML	79
2-1879296-8	TYAV2C105B13ML	79
2-1879296-9	TYAV2C225B13ML	79
2-1879297-0	TYAH1C226A12ML	85
2-1879297-1	TYAH1C336A12ML	85
2-1879297-2	TYAH1C476B13ML	85
2-1879297-3	TYAH1C107B13ML	85
2-1879297-4	TYAH1C227C13ML	85
2-1879297-5	TYAH1C337C16ML	85

Tyco Part No.	Brand Part No.	Page No.
2-1879304-6	TYRE1E188F20ML	67
2-1879304-7	TYRE1E228E35ML	67
2-1879304-8	TYRE1E228F25ML	67
2-1879304-9	TYRE1E228G20ML	67
2-1879305-0	TYRE1J227D25ML	67
2-1879305-1	TYRE1J277F16ML	67
2-1879305-2	TYRE1J337E20ML	67
2-1879305-3	TYRE1J397E25ML	67
2-1879305-4	TYRE1J397G16ML	67
2-1879305-5	TYRE1J477E25ML	67
2-1879305-6	TYRE1J477E30ML	67
2-1879305-7	TYRE1J477F20ML	67
2-1879305-8	TYRE1J567F25ML	67
2-1879305-9	TYRE1J687E35ML	67
2-1879306-0	TYRL2V228E20ML	75
2-1879306-1	TYRL2V338F20ML	75
2-1879306-2	TYRL2V476F25ML	75
2-1879306-3	TYRL2V476G20ML	75
2-1879306-4	TYRL2V686F31ML	75
2-1879306-5	TYRL2V686G25ML	75
2-1879306-6	TYRL2V107G31ML	75
2-1879306-7	TYRL2G106D20ML	75
2-1879306-8	TYRL2G156E20ML	75
2-1879306-9	TYRL2G226E25ML	75
2-1879307-0	TVSV1E109J30ML	92
2-1879307-1	TVSV1E109K25ML	92
2-1879307-2	TVSV1E129H40ML	92
2-1879307-3	TVSV1E129J35ML	92
2-1879307-4	TVSV1E129K30ML	92
2-1879307-5	TVSV1E159H50ML	92
2-1879307-6	TVSV1E159J40ML	92
2-1879307-7	TVSV1E159K35ML	92
2-1879307-8	TVSV1E189J45ML	92
2-1879307-9	TVSV1E189K35ML	92
2-1879308-0	TVSV2A338L35ML	92
2-1879308-1	TVSV2A398K45ML	92
2-1879308-2	TVSV2A398L35ML	92
2-1879308-3	TVSV2A478K50ML	92
2-1879308-4	TVSV2A478L40ML	92
2-1879308-5	TVSV2A568L45ML	92
2-1879308-6	TVSV2A688L50ML	92
2-1879308-7	TVSV2C277H25ML	92
2-1879308-8	TVSV2C337H25ML	92
2-1879308-9	TVSV2C397H30ML	92
2-1879309-0	TVSV2E567K30ML	92
2-1879309-1	TVSV2E567K35ML	92
2-1879309-2	TVSV2E567L25ML	92
2-1879309-3	TVSV2E687J45ML	92
2-1879309-4	TVSV2E687J50ML	92
2-1879309-5	TVSV2E687K35ML	92
2-1879309-6	TVSV2E687K40ML	92
2-1879309-7	TVSV2E687L30ML	92
2-1879309-8	TVSV2E827K40ML	92
2-1879309-9	TVSV2E827K45ML	92
2-1879310-0	TVSV2W826H30ML	92
2-1879310-1	TVSV2W826J25ML	92
2-1879310-2	TVSV2W107H35ML	92
2-1879310-3	TVSV2W107J25ML	92
2-1879310-4	TVSV2W127H35ML	92
2-1879310-5	TVSV2W127H40ML	92
2-1879310-6	TVSV2W127J30ML	92
2-1879310-7	TVSV2W127K25ML	92
2-1879310-8	TVSV2W157H40ML	92
2-1879310-9	TVSV2W157J35ML	92
2-1879311-0	TYSH1E828H35ML	103
2-1879311-1	TYSH1E828J30ML	103
2-1879311-2	TYSH1E828K25ML	103
2-1879311-3	TYSH1E109H40ML	103
2-1879311-4	TYSH1E109J35ML	103
2-1879311-5	TYSH1E129H45ML	103
2-1879311-6	TYSH1E129J40ML	103
2-1879311-7	TYSH1E129K30ML	103
2-1879311-8	TYSH1E129L25ML	103
2-1879311-9	TYSH1E159J45ML	103
2-1879312-0	TYSH2A568L50ML	103
2-1879312-1	TYSH2C277H25ML	103
2-1879312-2	TYSH2C337H30ML	103
2-1879312-3	TYSH2C397H30ML	103
2-1879312-4	TYSH2C397J25ML	103
2-1879312-5	TYSH2C477H35ML	103
2-1879312-6	TYSH2C477J25ML	103

Tyco Part No.	Brand Part No.	Page No.
2-1879312-7	TYSH2C477J30ML	103
2-1879312-8	TYSH2C567H40ML	103
2-1879312-9	TYSH2C567J30ML	103
2-1879313-0	TYSH2V277K35ML	103
2-1879313-1	TYSH2V277L30ML	103
2-1879313-2	TYSH2V337K45ML	103
2-1879313-3	TYSH2V397L40ML	103
2-1879313-4	TYSH2V477L45ML	103
2-1879313-5	TYSH2V567L50ML	103
2-1879313-6	TYSH2G686H30ML	103
2-1879313-7	TYSH2G826H30ML	103
2-1879313-8	TYSH2G826J25ML	103
2-1879313-9	TYSH2G107H35ML	103
3-1676850-0	TYC0402A121JFT	26
3-1676850-1	TYC0402A151JFT	26
3-1676850-2	TYC0402A181JFT	26
3-1676850-3	TYC0402A221JFT	26
3-1676850-4	TYC0402A271JFT	26
3-1676850-5	TYC0402A311JFT	26
3-1676850-6	TYC0402A361JFT	26
3-1676850-7	TYC0402A411JFT	26
3-1676850-8	TYC0402A461JFT	26
3-1676850-9	TYC0402A511JFT	26
3-1676851-0	TYC0402A561JFT	26
3-1676851-1	TYC0402A611JFT	26
3-1676851-2	TYC0402A661JFT	26
3-1676851-3	TYC0402A711JFT	26
3-1676851-4	TYC0402A761JFT	26
3-1676851-5	TYC0402A811JFT	26
3-1676851-6	TYC0402A861JFT	26
3-1676851-7	TYC0402A911JFT	26
3-1676851-8	TYC0402A961JFT	26
3-1676851-9	TYC0402A1011JFT	26
3-1676852-0	TYC0603A121JFT	26
3-1676852-1	TYC0603A151JFT	26
3-1676852-2	TYC0603A181JFT	26
3-1676852-3	TYC0603A221JFT	26
3-1676852-4	TYC0603A271JFT	26
3-1676852-5	TYC0603A311JFT	26
3-1676852-6	TYC0603A361JFT	26
3-1676852-7	TYC0603A411JFT	26
3-1676852-8	TYC0603A461JFT	26
3-1676852-9	TYC0603A511JFT	26
3-1676853-0	TYC0603A561JFT	26
3-1676853-1	TYC0603A611JFT	26
3-1676853-2	TYC0603A661JFT	26
3-1676853-3	TYC0603A711JFT	26
3-1676853-4	TYC0603A761JFT	26
3-1676853-5	TYC0603A811JFT	26
3-1676853-6	TYC0603A861JFT	26
3-1676853-7	TYC0603A911JFT	26
3-1676853-8	TYC0603A961JFT	26
3-1676853-9	TYC0603A1011JFT	26
3-1676854-0	TYC0603A121JGT	26
3-1676854-1	TYC0603A151JGT	26
3-1676854-2	TYC0603A181JGT	26
3-1676854-3	TYC0603A221JGT	26
3-1676854-4	TYC0603A271JGT	26
3-1676854-5	TYC0603A311JGT	26
3-1676854-6	TYC0603A361JGT	26
3-1676854-7	TYC0603A411JGT	26
3-1676854-8	TYC0603A461JGT	26
3-1676854-9	TYC0603A511JGT	26
3-1676855-0	TYC0603A561JGT	26
3-1676855-1	TYC0603A611JGT	26
3-1676855-2	TYC0603A661JGT	26
3-1676855-3	TYC0603A711JGT	26
3-1676855-4	TYC0603A761JGT	26
3-1676855-5	TYC0603A811JGT	26
3-1676855-6	TYC0603A861JGT	26
3-1676855-7	TYC0603A911JGT	26
3-1676855-8	TYC0603A961JGT	26
3-1676855-9	TYC0603A1011JGT	26
3-1676856-0	TYC0805A121JFT	26
3-1676856-1	TYC0805A151JFT	26
3-1676856-2	TYC0805A181JFT	26
3-1676856-3	TYC0805A221JFT	26
3-1676856-4	TYC0805A271JFT	26
3-1676856-5	TYC0805A311JFT	26
3-1676856-6	TYC0805A361JFT	26
3-1676856-7	TYC0805A411JFT	26
3-1676856-8	TYC0805A461JFT	26
3-1676856-9	TYC0805A511JFT	26
3-1676857-0	TYC0805A561JFT	26
3-1676857-1	TYC0805A611JFT	26
3-1676857-2	TYC0805A661JFT	26
3-1676857-3	TYC0805A711JFT	26
3-1676857-4	TYC0805A761JFT	26
3-1676857-5	TYC0805A811JFT	26
3-1676857-6	TYC0805A861JFT	26
3-1676857-7	TYC0805A911JFT	26
3-1676857-8	TYC0805A961JFT	26
3-1676857-9	TYC0805A1011JFT	26
3-1676858-0	TYC0805A121JHT	26
3-1676858-1	TYC0805A151JHT	26
3-1676858-2	TYC0805A181JHT	26
3-1676858-3	TYC0805A221JHT	26
3-1676858-4	TYC0805A271JHT	26
3-1676858-5	TYC0805A311JHT	26
3-1676858-6	TYC0805A361JHT	26
3-1676858-7	TYC0805A411JHT	26
3-1676858-8	TYC0805A461JHT	26
3-1676858-9	TYC0805A511JHT	26

Tyco Part No.	Brand Part No.	Page No.
3-1676859-0	TYC0805A121JJT	26
3-1676859-1	TYC0805A151JJT	26
3-1676859-2	TYC0805A181JJT	26
3-1676859-3	TYC0805A221JJT	26
3-1676859-4	TYC0805A271JJT	26
3-1676859-5	TYC0805A311JJT	26
3-1676859-6	TYC0805A361JJT	26
3-1676859-7	TYC0805A411JJT	26
3-1676859-8	TYC0805A461JJT	26
3-1676860-0	TYC1206A121JGT	26
3-1676860-1	TYC1206A151JGT	26
3-1676860-2	TYC1206A181JGT	26
3-1676860-3	TYC1206A221JGT	26
3-1676860-4	TYC1206A271JGT	26
3-1676860-5	TYC1206A311JGT	26
3-1676860-6	TYC1206A361JGT	26
3-1676860-7	TYC1206A391JGT	26
3-1676860-8	TYC1206A471JGT	26
3-1676860-9	TYC1206A561JGT	26
3-1676861-0	TYC1206A681JGT	26
3-1676861-1	TYC1206A121JHT	26
3-1676861-2	TYC1206A151JHT	26
3-1676861-3	TYC1206A181JHT	26
3-1676861-4	TYC1206A221JHT	26
3-1676861-5	TYC1206A271JHT	26
3-1676861-6	TYC1206A311JHT	26
3-1676861-7	TYC1206A361JHT	26
3-1676861-8	TYC1206A391JHT	26
3-1676861-9	TYC1206A471JHT	26
3-1676862-0	TYC1206A561JHT	26
3-1676862-1	TYC1206A681JHT	26
3-1676862-2	TYC1206A811JHT	26
3-1676862-3	TYC1206A121JJT	26
3-1676862-4	TYC1206A151JJT	26
3-1676862-5	TYC1206A181JJT	26
3-1676862-6	TYC1206A221JJT	26
3-1676862-7	TYC1206A271JJT	26
3-1676862-8	TYC1206A311JJT	26
3-1676862-9	TYC1206A361JJT	26
3-1676863-0	TYC1206A391JJT	26
3-1676863-1	TYC1206A471JJT	26
3-1676863-2	TYC1206A561JJT	26
3-1676863-3	TYC1206A681JJT	26
3-1676863-4	TYC1206A121JLT	26
3-1676863-5	TYC1206A151JLT	26
3-1676863-6	TYC1206A181JLT	26
3-1676863-7	TYC1206A221JLT	26
3-1676863-8	TYC1206A271JLT	26
3-1676863-9	TYC1206A311JLT	26
3-1676863-0	TYC1206A361JLT	26
3-1676863-1	TYC1206A391JLT	26
3-1676863-2	TYC1206A471JLT	26
3-1676863-3	TYC1206A561JLT	26
3-1676863-4	TYC1206A681JLT	26
3-1676863-5	TYC1206A811JLT	26
3-1676863-6	TYC1206A121JLT	26
3-1676863-7	TYC1206A151JLT	26
3-1676863-8	TYC1206A181JLT	26
3-1676863-9	TYC1206A221JLT	26
3-1676864-0	TYC1206A271JLT	26
3-1676864-1	TYC1206A311JLT	26
3-1676864-2	TYC1206A361JLT	26
3-1676864-3	TYC1206A391JLT	26
3-1676864-4	TYC1206A471JLT	26
3-1676864-5	TYC1206A561JLT	26
3-1676864-6	TYC1206A681JLT	26
3-1676864-7	TYC1206A811JLT	26
3-1676864-8	TYC1206A121JKT	26
3-1676864-9	TYC1206A151JKT	26
3-1676865-0	TYC0603B124KDT	26
3-1676865-1	TYC0603B154KDT	26
3-1676865-2	TYC0603B184KDT	26
3-1676865-3	TYC0603B214KDT	26
3-1676865-4	TYC0603B244KDT	26
3-1676865-5	TYC0603B274KDT	26
3-1676865-6	TYC0603B304KDT	26
3-1676865-7	TYC0603B334KDT	26
3-1676865-8	TYC0603B364KDT	26
3-1676865-9	TYC0603B394KDT	26
3-1676866-0	TYC0603B424KDT	26
3-1676866-1	TYC0603B454KDT	26
3-1676866-2	TYC0603B484KDT	26
3-1676866-3	TYC0603B514KDT	26
3-1676866-4	TYC0	

Tyco Electronics to Brand Part Number Index

Tyco Part No.	Brand Part No.	Page No.
3-1676906-3	TYTTP1D154MTRF	15
3-1676906-4	TYTTP1D224MTRF	15
3-1676906-5	TYTTP1D334MTRF	15
3-1676906-6	TYTTP1D474MTRF	15
3-1676906-7	TYTTP1D684MTRF	15
3-1676906-8	TYTTP1E473MTRF	15
3-1676906-9	TYTTP1E683MTRF	15
3-1676909-0	TYTRD1D336MTRF	18
3-1676909-1	TYTRD1D476MTRF	18
3-1676909-2	TYTRD1E106MTRF	18
3-1676909-3	TYTRD1E156MTRF	18
3-1676909-4	TYTRD1E226MTRF	18
3-1676909-5	TYTRD1C155KTRF	18
3-1676909-6	TYTRD1V106MTRF	18
3-1676909-7	TYTRD1V156MTRF	18
3-1676909-8	TYTRD1V226MTRF	18
3-1879055-0	TYTMA1A335KTRF	9
3-1879055-1	TYTMA1A475KTRF	9
3-1879055-2	TYTMA1A685KTRF	9
3-1879055-3	TYTMA1C105KTRF	9
3-1879055-4	TYTMA1C106KTRF	9
3-1879055-5	TYTMA1C155KTRF	9
3-1879055-6	TYTMA1C225KTRF	9
3-1879055-7	TYTMA1C335KTRF	9
3-1879055-8	TYTMA1C475KTRF	9
3-1879055-9	TYTMA1C685KTRF	9
3-1879056-0	TYTMC0G68KTRF	9
3-1879056-1	TYTMC0J107KTRF	9
3-1879056-2	TYTMC0J157KTRF	9
3-1879056-3	TYTMC0J336KTRF	9
3-1879056-4	TYTMC0J476KTRF	9
3-1879056-5	TYTMC0J686KTRF	9
3-1879056-6	TYTMC1A107KTRF	9
3-1879056-7	TYTMC1A156KTRF	9
3-1879056-8	TYTMC1A226KTRF	9
3-1879056-9	TYTMC1A336KTRF	9
3-1879057-0	TYTTP0E475KTRF	15
3-1879057-1	TYTTP0E685KTRF	15
3-1879057-2	TYTTP0G106KTRF	15
3-1879057-3	TYTTP0G155KTRF	15
3-1879057-4	TYTTP0G156KTRF	15
3-1879057-5	TYTTP0G225KTRF	15
3-1879057-6	TYTTP0G226KTRF	15
3-1879057-7	TYTTP0G335KTRF	15
3-1879057-8	TYTTP0G475KTRF	15
3-1879057-9	TYTTP0G685KTRF	15
3-1879058-0	TYTSB1H334KTRF	6
3-1879058-1	TYTSB1V105KTRF	6
3-1879058-2	TYTSB1V474KTRF	6
3-1879058-3	TYTSB1V684KTRF	6
3-1879058-4	TYTSC0G336KTRF	6
3-1879058-5	TYTSC0J226KTRF	6
3-1879058-6	TYTSC1A156KTRF	6
3-1879058-7	TYTSC1C106KTRF	6
3-1879058-8	TYTSC1D685KTRF	6
3-1879058-9	TYTSC1E475KTRF	6
3-1879062-0	TYTRA1C105MTRF	18
3-1879062-1	TYTRA1C106KTRF	18
3-1879062-2	TYTRA1C106MTRF	18
3-1879062-3	TYTRA1C155KTRF	18
3-1879062-4	TYTRA1C155MTRF	18
3-1879062-5	TYTRA1C225KTRF	18
3-1879062-6	TYTRA1C225MTRF	18
3-1879062-7	TYTRA1C335KTRF	18
3-1879062-8	TYTRA1C335MTRF	18
3-1879062-9	TYTRA1C475KTRF	18
3-1879063-0	TYTRB1C156MTRF	18
3-1879063-1	TYTRB1C226KTRF	18
3-1879063-2	TYTRB1C226MTRF	18
3-1879063-3	TYTRB1C335KTRF	18
3-1879063-4	TYTRB1C335MTRF	18
3-1879063-5	TYTRB1C475KTRF	18
3-1879063-6	TYTRB1C475MTRF	18
3-1879063-7	TYTRB1C685KTRF	18
3-1879063-8	TYTRB1C685MTRF	18
3-1879063-9	TYTRB1D106KTRF	18
3-1879064-0	TYTRC1C336MTRF	18
3-1879064-1	TYTRC1C476KTRF	18
3-1879064-2	TYTRC1C476MTRF	18
3-1879064-3	TYTRC1D226KTRF	18
3-1879064-4	TYTRC1D226MTRF	18

Tyco Part No.	Brand Part No.	Page No.
3-1879064-5	TYTRC1D685KTRF	18
3-1879064-6	TYTRC1D685MTRF	18
3-1879064-7	TYTRC1E106KTRF	18
3-1879064-8	TYTRC1E106MTRF	18
3-1879064-9	TYTRC1E156KTRF	18
3-1879065-0	TYTRD1V475MTRF	18
3-1879065-1	TYTRD1V685KTRF	18
3-1879065-2	TYTRD1V685MTRF	18
3-1879065-3	TYTRE1A157KTRF	18
3-1879065-4	TYTRE1A157MTRF	18
3-1879065-5	TYTRE1C107KTRF	18
3-1879065-6	TYTRE1C107MTRF	18
3-1879065-7	TYTRE1C157KTRF	18
3-1879065-8	TYTRE1C157MTRF	18
3-1879065-9	TYTRE1E336KTRF	18
3-1879290-0	TYEV1C476F55MTR	36
3-1879290-1	TYEV1C107F55MTR	36
3-1879290-2	TYEV1C107G68MTR	36
3-1879290-3	TYEV1C227F80MTR	36
3-1879290-4	TYEV1C227G10MTR	36
3-1879290-5	TYEV1C337G10MTR	36
3-1879290-6	TYEV1C477G10MTR	36
3-1879290-7	TYEV1C477H10MTR	36
3-1879290-8	TYEV1E475D55MTR	36
3-1879290-9	TYEV1E106D55MTR	36
3-1879291-0	TYEH1E475D55MTR	40
3-1879291-1	TYEH1E106E55MTR	40
3-1879291-2	TYEH1E226F55MTR	40
3-1879291-3	TYEH1E336F55MTR	40
3-1879291-4	TYEH1E476F55MTR	40
3-1879291-5	TYEH1E476G68MTR	40
3-1879291-6	TYEH1E107F80MTR	40
3-1879291-7	TYEH1E107G10MTR	40
3-1879291-8	TYEH1E227G10MTR	40
3-1879291-9	TYEH1E227H10MTR	40
3-1879292-0	TYEL1E337H10MTR	46
3-1879292-1	TYEL1V475D60MTR	46
3-1879292-2	TYEL1V106E60MTR	46
3-1879292-3	TYEL1V226F60MTR	46
3-1879292-4	TYEL1V336F80MTR	46
3-1879292-5	TYEL1V476G10MTR	46
3-1879292-6	TYEL1V107H10MTR	46
3-1879292-7	TYEL1V227H10MTR	46
3-1879292-8	TYEL1H104D60MTR	46
3-1879292-9	TYEL1H224D60MTR	46
3-1879294-0	TYOH1A337H82MTR	49
3-1879294-1	TYOH1A477H10MTR	49
3-1879294-2	TYOH1A567H13MTR	49
3-1879294-3	TYOH1C476F62MTR	49
3-1879294-4	TYOH1C826G72MTR	49
3-1879294-5	TYOH1C187G12MTR	49
3-1879294-6	TYOH1C187H82MTR	49
3-1879294-7	TYOH1C227H10MTR	49
3-1879294-8	TYOH1C337H13MTR	49
3-1879294-9	TYOH1D226F62MTR	49
3-1879295-0	TYAV1C337C16ML	79
3-1879295-1	TYAV1C477C16ML	79
3-1879295-2	TYAV1C108D21ML	79
3-1879295-3	TYAV1C228E24ML	79
3-1879295-4	TYAV1C338F28ML	79
3-1879295-5	TYAV1C478F33ML	79
3-1879295-6	TYAV1C688G36ML	79
3-1879295-7	TYAV1C109G42ML	79
3-1879295-8	TYAV1E106A12ML	79
3-1879295-9	TYAV1E226A12ML	79
3-1879296-0	TYAV2C335C13ML	79
3-1879296-1	TYAV2C475C16ML	79
3-1879296-2	TYAV2C106D17ML	79
3-1879296-3	TYAV2C226D21ML	79
3-1879296-4	TYAV2C336E22ML	79
3-1879296-5	TYAV2C476E27ML	79
3-1879296-6	TYAV2C107F33ML	79
3-1879296-7	TYAV2C227G42ML	79
3-1879296-8	TYAV2C337H43ML	79
3-1879296-9	TYAV2D105B13ML	79
3-1879297-0	TYAH1C478F33ML	85
3-1879297-1	TYAH1E106A12ML	85
3-1879297-2	TYAH1E226A12ML	85
3-1879297-3	TYAH1E336A12ML	85
3-1879297-4	TYAH1E476B13ML	85
3-1879297-5	TYAH1E107C13ML	85

Tyco Part No.	Brand Part No.	Page No.
3-1879297-6	TYAH1E227C16ML	85
3-1879297-7	TYAH1E337D17ML	85
3-1879297-8	TYAH1E477D21ML	85
3-1879297-9	TYAH1E108E22ML	85
3-1879298-0	TYAH2D226E22ML	85
3-1879298-1	TYAH2D336E27ML	85
3-1879298-2	TYAH2D476F33ML	85
3-1879298-3	TYAH2D107F36ML	85
3-1879298-4	TYAH2D227H43ML	85
3-1879298-5	TYAH2E105B13ML	85
3-1879298-6	TYAH2E225C16ML	85
3-1879298-7	TYAH2E335C21ML	85
3-1879298-8	TYAH2E475D17ML	85
3-1879298-9	TYAH2E106D21ML	85
3-1879299-0	TYRV1C226A11ML	53
3-1879299-1	TYRV1C336A11ML	53
3-1879299-2	TYRV1C476A11ML	53
3-1879299-3	TYRV1C107A11ML	53
3-1879299-4	TYRV1C227B11ML	53
3-1879299-5	TYRV1C337C11ML	53
3-1879299-6	TYRV1C477C11ML	53
3-1879299-7	TYRV1C108D16ML	53
3-1879299-8	TYRV1C228E20ML	53
3-1879299-9	TYRV1C338E25ML	53
3-1879300-0	TYRV2C475B11ML	53
3-1879300-1	TYRV2C106D12ML	53
3-1879300-2	TYRV2C226D20ML	53
3-1879300-3	TYRV2C336D20ML	53
3-1879300-4	TYRV2C476E20ML	53
3-1879300-5	TYRV2C107E25ML	53
3-1879300-6	TYRV2C227F31ML	53
3-1879300-7	TYRV2C337G35ML	53
3-1879300-8	TYRV2D474B11ML	53
3-1879300-9	TYRV2D105B11ML	53
3-1879301-0	TYRH1C476A11ML	60
3-1879301-1	TYRH1C107A11ML	60
3-1879301-2	TYRH1C227B11ML	60
3-1879301-3	TYRH1C337C11ML	60
3-1879301-4	TYRH1C477C11ML	60
3-1879301-5	TYRH1C108D16ML	60
3-1879301-6	TYRH1C228E20ML	60
3-1879301-7	TYRH1C338E25ML	60
3-1879301-8	TYRH1C477F25ML	60
3-1879301-9	TYRH1C108F31ML	60
3-1879302-0	TYRH2C107F25ML	60
3-1879302-1	TYRH2C227F31ML	60
3-1879302-2	TYRH2C337G35ML	60
3-1879302-3	TYRH2D474B11ML	60
3-1879302-4	TYRH2D105B11ML	60
3-1879302-5	TYRH2D225B11ML	60
3-1879302-6	TYRH2D335B11ML	60
3-1879302-7	TYRH2D475C11ML	60
3-1879302-8	TYRH2D106D12ML	60
3-1879302-9	TYRH2D226D20ML	60
3-1879303-0	Tyre0J109F31ML	67
3-1879303-1	Tyre0J109G25ML	67
3-1879303-2	Tyre0J129G31ML	67
3-1879303-3	Tyre0J159G35ML	67
3-1879303-4	Tyre1A226A11ML	67
3-1879303-5	Tyre1A336A11ML	67
3-1879303-6	Tyre1A476A11ML	67
3-1879303-7	Tyre1A826A11ML	67
3-1879303-8	Tyre1A107A11ML	67
3-1879303-9	Tyre1A157B11ML	67
3-1879304-0	Tyre1E278F25ML	67
3-1879304-1	Tyre1E338F31ML	67
3-1879304-2	Tyre1E338G25ML	67
3-1879304-3	Tyre1E398F35ML	67
3-1879304-4	Tyre1E398G31ML	67
3-1879304-5	Tyre1E478G35ML	67
3-1879304-6	Tyre1E688G40ML	67
3-1879304-7	Tyre1V475A11ML	67
3-1879304-8	Tyre1V106A11ML	67
3-1879304-9	Tyre1V226A11ML	67
3-1879305-0	Tyre1J687G20ML	67
3-1879305-1	Tyre1J827F31ML	67
3-1879305-2	Tyre1J827G25ML	67
3-1879305-3	Tyre1J108F31ML	67
3-1879305-4	Tyre1J108F35ML	67
3-1879305-5	Tyre1J128G31ML	67
3-1879305-6	Tyre1J158G35ML	67

Tyco Part No.	Brand Part No.	Page No.
3-1879305-7	TYRE1J228G40ML	67
3-1879305-8	TYRE2A474A11ML	67
3-1879305-9	TYRE2A105A11ML	67
3-1879306-0	TYRL2G226F20ML	75
3-1879306-1	TYRL2G336F25ML	75
3-1879306-2	TYRL2G476F31ML	75
3-1879306-3	TYRL2G476G25ML	75
3-1879306-4	TYRL2G686G31ML	75
3-1879306-5	TYRL2G107G35ML	75
3-1879306-6	TYRL2W475D20ML	75
3-1879306-7	TYRL2W106E20ML	75
3-1879306-8	TYRL2W156E25ML	75
3-1879306-9	TYRL2W226L25ML	75
3-1879307-0	TYSV1E189L30ML	92
3-1879307-1	TYSV1E229K45ML	92
3-1879307-2	TYSV1E229L35ML	92
3-1879307-3	TYSV1V478H30ML	92
3-1879307-4	TYSV1V478J25ML	92
3-1879307-5	TYSV1V568H35ML	92
3-1879307-6	TYSV1V688H40ML	92
3-1879307-7	TYSV1V688J30ML	92
3-1879307-8	TYSV1V828H25ML	92
3-1879307-9	TYSV1V828H45ML	92
3-1879308-0	TYSV2C477J25ML	92
3-1879308-1	TYSV2C567H30ML	92
3-1879308-2	TYSV2C567H35ML	92
3-1879308-3	TYSV2C687J25ML	92
3-1879308-4	TYSV2C687J30ML	92

Tyco Electronics to Brand Part Number Index

Tyco Part No.	Brand Part No.	Page No.
3-1879313-8	TYSH2G157J35ML	103
3-1879313-9	TYSH2G157J40ML	103
4-1676853-0	TYC0603A821JFT	26
4-1676853-1	TYC0603A102JFT	26
4-1676853-2	TYC0603A122JFT	26
4-1676853-3	TYC0603A152JFT	26
4-1676854-0	TYC0603A821JFT	26
4-1676854-1	TYC0603A102JFT	26
4-1676854-2	TYC0603A122JFT	26
4-1676856-0	TYC0805A821JFT	26
4-1676856-1	TYC0805A102JFT	26
4-1676856-2	TYC0805A122JFT	26
4-1676856-3	TYC0805A152JFT	26
4-1676856-4	TYC0805A182JFT	26
4-1676856-5	TYC0805A222JFT	26
4-1676856-6	TYC0805A272JFT	26
4-1676856-7	TYC0805A332JFT	26
4-1676856-8	TYC0805A392JFT	26
4-1676856-9	TYC0805A472JFT	26
4-1676857-0	TYC0805A821JFT	26
4-1676857-1	TYC0805A102JFT	26
4-1676857-2	TYC0805A122JFT	26
4-1676857-3	TYC0805A152JFT	26
4-1676857-4	TYC0805A182JFT	26
4-1676857-5	TYC0805A222JFT	26
4-1676857-6	TYC0805A272JFT	26
4-1676857-7	TYC0805A332JFT	26
4-1676857-8	TYC0805A392JFT	26
4-1676857-9	TYC0805A472JFT	26
4-1676858-0	TYC0805A821JHT	26
4-1676858-1	TYC0805A102JHT	26
4-1676858-2	TYC0805A122JHT	26
4-1676858-3	TYC0805A152JHT	26
4-1676858-4	TYC0805A182JHT	26
4-1676858-5	TYC0805A222JHT	26
4-1676860-0	TYC1206A821JGT	26
4-1676860-1	TYC1206A102JGT	26
4-1676860-2	TYC1206A122JGT	26
4-1676860-3	TYC1206A152JGT	26
4-1676860-4	TYC1206A182JGT	26
4-1676860-5	TYC1206A222JGT	26
4-1676860-6	TYC1206A272JGT	26
4-1676860-7	TYC1206A332JGT	26
4-1676860-8	TYC1206A392JGT	26
4-1676860-9	TYC1206A472JGT	26
4-1676861-0	TYC1206A821JHT	26
4-1676861-1	TYC1206A102JHT	26
4-1676861-2	TYC1206A122JHT	26
4-1676861-3	TYC1206A152JHT	26
4-1676861-4	TYC1206A182JHT	26
4-1676861-5	TYC1206A222JHT	26
4-1676861-6	TYC1206A272JHT	26
4-1676861-7	TYC1206A332JHT	26
4-1676861-8	TYC1206A392JHT	26
4-1676861-9	TYC1206A472JHT	26
4-1676862-0	TYC1206A821JJT	26
4-1676862-1	TYC1206A102JJT	26
4-1676862-2	TYC1206A122JJT	26
4-1676862-3	TYC1206A152JJP	26
4-1676863-0	TYC1206A821JLP	26
4-1676863-1	TYC1206A102JLP	26
4-1676868-0	TYC0603B184KDT	26
4-1676868-1	TYC0603B224KDT	26
4-1676873-1	TYC0805B224KDT	26
4-1676873-2	TYC0805B274KDT	26
4-1676873-3	TYC0805B334KDT	26
4-1676873-4	TYC0805B394KDT	26
4-1676873-5	TYC0805B474KDT	26
4-1676873-6	TYC0805B564KDT	26
4-1676873-7	TYC0805B684KDT	26
4-1676873-8	TYC0805B824KDP	26
4-1676873-9	TYC0805B105KDP	26
4-1676874-0	TYC0805B184KET	26
4-1676874-1	TYC0805B224KET	26
4-1676874-2	TYC0805B274KET	26
4-1676874-3	TYC0805B334KET	26
4-1676874-4	TYC0805B394KET	26
4-1676874-5	TYC0805B474KET	26
4-1676874-6	TYC0805B564KET	26
4-1676874-7	TYC0805B684KET	26
4-1676874-8	TYC0805B824KET	26

Tyco Part No.	Brand Part No.	Page No.
4-1676874-9	TYC0805B105KEP	26
4-1676879-9	TYC1206B105KDT	26
4-1676880-3	TYC1206B334KET	26
4-1676880-4	TYC1206B394KET	26
4-1676880-5	TYC1206B474KET	26
4-1676880-6	TYC1206B564KET	26
4-1676880-7	TYC1206B684KET	26
4-1676880-8	TYC1206B824KET	26
4-1676880-9	TYC1206B105KEP	26
4-1676881-0	TYC1206B184KFT	26
4-1676881-1	TYC1206B224KFT	26
4-1676881-2	TYC1206B274KFT	26
4-1676881-3	TYC1206B334KFT	26
4-1676881-4	TYC1206B394KFT	26
4-1676882-0	TYC1206B184KGP	26
4-1676882-1	TYC1206B224KGP	26
4-1676902-0	TYTSB1H334MTRF	6
4-1676902-1	TYTSC1H474MTRF	6
4-1676902-2	TYTSC1H684MTRF	6
4-1676902-3	TYTSC1H105MTRF	6
4-1676902-4	TYTSD1H155MTRF	6
4-1676902-5	TYTSD1H225MTRF	6
4-1676903-0	TYTMC0G227MTRF	9
4-1676903-1	TYTMD0G227MTRF	9
4-1676903-2	TYTMD0G337MTRF	9
4-1676903-3	TYTMD0G477MTRF	9
4-1676903-4	TYTMA0J335MTRF	9
4-1676903-5	TYTMA0J475MTRF	9
4-1676903-6	TYTMA0J685MTRF	9
4-1676903-7	TYTMA0J106MTRF	9
4-1676903-8	TYTMB0J106MTRF	9
4-1676903-9	TYTMA0J156MTRF	9
4-1676904-0	TYTMB1E475MTRF	9
4-1676904-1	TYTMC1E685MTRF	9
4-1676904-2	TYTMC1E106MTRF	9
4-1676904-3	TYTMC1E156MTRF	9
4-1676904-4	TYTMD1E156MTRF	9
4-1676904-5	TYTMD1E226MTRF	9
4-1676904-6	TYTMD1E336MTRF	9
4-1676904-7	TYTMA1V474MTRF	9
4-1676904-8	TYTMA1V684MTRF	9
4-1676904-9	TYTMA1V105MTRF	9
4-1879055-0	TYTMA1D105KTRF	9
4-1879055-1	TYTMA1D155KTRF	9
4-1879055-2	TYTMA1D225KTRF	9
4-1879055-3	TYTMA1D335KTRF	9
4-1879055-4	TYTMA1D475KTRF	9
4-1879055-5	TYTMA1D684KTRF	9
4-1879055-6	TYTMA1E105KTRF	9
4-1879055-7	TYTMA1E155KTRF	9
4-1879055-8	TYTMA1E274KTRF	9
4-1879055-9	TYTMA1E474KTRF	9
4-1879055-0	TYTMA1E684KTRF	9
4-1879056-0	TYTMC1A476KTRF	9
4-1879056-1	TYTMC1A686KTRF	9
4-1879056-2	TYTMC1C106KTRF	9
4-1879056-3	TYTMC1C156KTRF	9
4-1879056-4	TYTMC1C226KTRF	9
4-1879056-5	TYTMC1C336KTRF	9
4-1879056-6	TYTMC1C476KTRF	9
4-1879056-7	TYTMC1D106KTRF	9
4-1879056-8	TYTMC1D156KTRF	9
4-1879056-9	TYTMC1D226KTRF	9
4-1879057-0	TYTPOJ105KTRF	15
4-1879057-1	TYTPOJ106KTRF	15
4-1879057-2	TYTPOJ155KTRF	15
4-1879057-3	TYTPOJ225KTRF	15
4-1879057-4	TYTPOJ335KTRF	15
4-1879057-5	TYTPOJ475KTRF	15
4-1879057-6	TYTPOJ685KTRF	15
4-1879057-7	TYTTP1A105KTRF	15
4-1879057-8	TYTTP1A155KTRF	15
4-1879057-9	TYTTP1A225KTRF	15
4-1879058-0	TYTSC1H105KTRF	6
4-1879058-1	TYTSC1H474KTRF	6
4-1879058-2	TYTSC1H684KTRF	6
4-1879058-3	TYTSC1V155KTRF	6
4-1879058-4	TYTSC1V225KTRF	6
4-1879058-5	TYTSC1V335KTRF	6
4-1879058-6	TYTSD0G688KTRF	6
4-1879058-7	TYTSD0J476KTRF	6
4-1879058-8	TYTSD1A336KTRF	6

Tyco Part No.	Brand Part No.	Page No.
4-1879058-9	TYTSD1C226KTRF	6
4-1879062-0	TYTRA1C475MTRF	18
4-1879062-1	TYTRA1C685KTRF	18
4-1879062-2	TYTRA1C685MTRF	18
4-1879062-3	TYTRA1D105KTRF	18
4-1879062-4	TYTRA1D105MTRF	18
4-1879062-5	TYTRA1D155KTRF	18
4-1879062-6	TYTRA1D155MTRF	18
4-1879062-7	TYTRA1D225KTRF	18
4-1879062-8	TYTRA1D225MTRF	18
4-1879062-9	TYTRA1D335KTRF	18
4-1879063-0	TYTRB1D106MTRF	18
4-1879063-1	TYTRB1D225KTRF	18
4-1879063-2	TYTRB1D225MTRF	18
4-1879063-3	TYTRB1D335KTRF	18
4-1879063-4	TYTRB1D335MTRF	18
4-1879063-5	TYTRB1D475KTRF	18
4-1879063-6	TYTRB1D475MTRF	18
4-1879063-7	TYTRB1D685KTRF	18
4-1879063-8	TYTRB1D685MTRF	18
4-1879063-9	TYTRB1E155KTRF	18
4-1879064-0	TYTRC1E156MTRF	18
4-1879064-1	TYTRC1E475KTRF	18
4-1879064-2	TYTRC1E475MTRF	18
4-1879064-3	TYTRC1E685KTRF	18
4-1879064-4	TYTRC1E685MTRF	18
4-1879064-5	TYTRC1H105KTRF	18
4-1879064-6	TYTRC1H105MTRF	18
4-1879064-7	TYTRC1H155KTRF	18
4-1879064-8	TYTRC1H155MTRF	18
4-1879064-9	TYTRC1H225KTRF	18
4-1879065-0	TYTRE1E336MTRF	18
4-1879065-1	TYTRE1E476KTRF	18
4-1879065-2	TYTRE1E476MTRF	18
4-1879065-3	TYTRE1H106KTRF	18
4-1879065-4	TYTRE1H106MTRF	18
4-1879065-5	TYTRE1H685KTRF	18
4-1879065-6	TYTRE1H685MTRF	18
4-1879065-7	TYTRE1V156KTRF	18
4-1879065-8	TYTRE1V156MTRF	18
4-1879065-9	TYTRE1V226KTRF	18
4-1879290-0	TYEV1E106E55MTR	36
4-1879290-1	TYEV1E226E55MTR	36
4-1879290-2	TYEV1E226F55MTR	36
4-1879290-3	TYEV1E336E55MTR	36
4-1879290-4	TYEV1E336F55MTR	36
4-1879290-5	TYEV1E476F55MTR	36
4-1879290-6	TYEV1E107F80MTR	36
4-1879290-7	TYEV1E107G68MTR	36
4-1879290-8	TYEV1E227G10MTR	36
4-1879290-9	TYEV1E337G10MTR	36
4-1879291-0	TYEH1E337H10MTR	40
4-1879291-1	TYEH1E477H10MTR	40
4-1879291-2	TYEH1V475D55MTR	40
4-1879291-3	TYEH1V106E55MTR	40
4-1879291-4	TYEH1V226F55MTR	40
4-1879291-5	TYEH1V336F60MTR	40
4-1879291-6	TYEH1V336G68MTR	40
4-1879291-7	TYEH1V476G10MTR	40
4-1879291-8	TYEH1V107H10MTR	40
4-1879291-9	TYEH1V107G10MTR	40
4-1879292-0	TYEL1H334D60MTR	46
4-1879292-1	TYEL1H474D60MTR	46
4-1879292-2	TYEL1H105D60MTR	46
4-1879292-3	TYEL1H225D60MTR	46
4-1879292-4	TYEL1H335D60MTR	46
4-1879292-5	TYEL1H475E60MTR	46
4-1879292-6	TYEL1H106F60MTR	46
4-1879292-7	TYEL1H226F80MTR	46
4-1879292-8	TYEL1H336G10MTR	46
4-1879292-9	TYEL1H476G10MTR	46
4-1879294-0	TYOH1D476G72MTR	49
4-1879294-1	TYOH1D826H82MTR	49
4-1879294-2	TYOH1D107G12MTR	49
4-1879294-3	TYOH1D107H10MTR	49
4-1879294-4	TYOH1D157H13MTR	49
4-1879294-5	TYOH1E685F62MTR	49
4-1879294-6	TYOH1E336G12MTR	49
4-1879294-7	TYOH1E566H13MTR	49
4-1879295-0	TYAV1E336A12ML	79
4-1879295-1	TYAV1E476B13ML	79

Tyco Part No.	Brand Part No.	Page No.
4-1879295-2	TYAV1E107C13ML	79
4-1879295-3	TYAV1E227C16ML	79
4-1879295-4	TYAV1E337D17ML	79
4-1879295-5	TYAV1E477D21ML	79
4-1879295-6	TYAV1E108E22ML	79
4-1879295-7	TYAV1E228F28ML	79
4-1879295-8	TYAV1E338F33ML	79
4-1879295-9	TYAV1E478G36ML	79
4-1879296-0	TYAV2D225C13ML	79
4-1879296-1	TYAV2D335C16ML	79
4-1879296-2	TYAV2D475D17ML	79
4-1879296-3	TYAV2D106D21ML	79
4-1879296-4	TYAV2D226E21ML	79
4-1879296-5	TYAV2D336E27ML	79
4-1879296-6	TYAV2D476F33ML	79
4-1879296-7	TYAV2D227H43ML	79
4-1879296-8	TYAV2E105B13ML	79
4-1879296-9	TYAH1E28F28ML	85
4-1879297-0	TYAH1E338F33ML	85
4-1879297-1	TYAH1E478G36ML	85
4-1879297-2	TYAH1V106A12ML	85
4-1879297-3	TYAH1V226B13ML	85
4-1879297-4	TYAH1V336B13ML	85
4-1879297-5	TYAH1V476B13ML	85
4-1879297-6	TYAH1V107C16ML	85
4-1879297-7		

Tyco Electronics to Brand Part Number Index

Tyco Part No.	Brand Part No.	Page No.
4-1879303-3	TYRE1A337C11ML	67
4-1879303-4	TYRE1A477C11ML	67
4-1879303-5	TYRE1A687C15ML	67
4-1879303-6	TYRE1A687D12ML	67
4-1879303-7	TYRE1A108C20ML	67
4-1879303-8	TYRE1A108D16ML	67
4-1879303-9	TYRE1A128D20ML	67
4-1879304-0	TYRE1V276A11ML	67
4-1879304-1	TYRE1V336A11ML	67
4-1879304-2	TYRE1V476B11ML	67
4-1879304-3	TYRE1V566B11ML	67
4-1879304-4	TYRE1V826B15ML	67
4-1879304-5	TYRE1V107C11ML	67
4-1879304-6	TYRE1V157C11ML	67
4-1879304-7	TYRE1V227C15ML	67
4-1879304-8	TYRE1V227D12ML	67
4-1879304-9	TYRE1V337C20ML	67
4-1879305-0	TYRE2A225A11ML	67
4-1879305-1	TYRE2A335A11ML	67
4-1879305-2	TYRE2A475A11ML	67
4-1879305-3	TYRE2A685A11ML	67
4-1879305-4	TYRE2A106B11ML	67
4-1879305-5	TYRE2A156C11ML	67
4-1879305-6	TYRE2A186B15ML	67
4-1879305-7	TYRE2A226C11ML	67
4-1879305-8	TYRE2A336C15ML	67
4-1879305-9	TYRE2A336D12ML	67
4-1879306-0	TYRL2W336F31ML	75
4-1879306-1	TYRL2W336G25ML	75
4-1879306-2	TYRL2W476G31ML	75
4-1879306-3	TYRL2W686G35ML	75
4-1879307-0	TYSV1V828J35ML	92
4-1879307-1	TYSV1V828K30ML	92
4-1879307-2	TYSV1V109H50ML	92
4-1879307-3	TYSV1V109J40ML	92
4-1879307-4	TYSV1V109K30ML	92
4-1879307-5	TYSV1V109L25ML	92
4-1879307-6	TYSV1V129J45ML	92
4-1879307-7	TYSV1V129K35ML	92
4-1879307-8	TYSV1V129L30ML	92
4-1879307-9	TYSV1V129M30ML	92
4-1879308-0	TYSV2C827H40ML	92
4-1879308-1	TYSV2C827H45ML	92
4-1879308-2	TYSV2C827J35ML	92
4-1879308-3	TYSV2C827J35ML	92
4-1879308-4	TYSV2C827K25ML	92
4-1879308-5	TYSV2C827K30ML	92
4-1879308-6	TYSV2C108H50ML	92
4-1879308-7	TYSV2C108J40ML	92
4-1879308-8	TYSV2C108J45ML	92
4-1879308-9	TYSV2C108K30ML	92
4-1879309-0	TYSV2V157H35ML	92
4-1879309-1	TYSV2V157J25ML	92
4-1879309-2	TYSV2V157J30ML	92
4-1879309-3	TYSV2V157K25ML	92
4-1879309-4	TYSV2V187H40ML	92
4-1879309-5	TYSV2V187J30ML	92
4-1879309-6	TYSV2V187K25ML	92
4-1879309-7	TYSV2V227H40ML	92
4-1879309-8	TYSV2V227H45ML	92
4-1879309-9	TYSV2V227J45ML	92
4-1879310-0	TYSV2W227K35ML	92
4-1879310-1	TYSV2W227K40ML	92
4-1879310-2	TYSV2W227L30ML	92
4-1879310-3	TYSV2W227K40ML	92
4-1879310-4	TYSV2W277K45ML	92
4-1879310-5	TYSV2W277L35ML	92
4-1879310-6	TYSV2W337K45ML	92
4-1879310-7	TYSV2W337K50ML	92
4-1879310-8	TYSV2W337L35ML	92
4-1879310-9	TYSV2W337L40ML	92
4-1879311-0	TYSH1V688H40ML	103
4-1879311-1	TYSH1V688J35ML	103
4-1879311-2	TYSH1V828H50ML	103
4-1879311-3	TYSH1V828J40ML	103
4-1879311-4	TYSH1V828K30ML	103
4-1879311-5	TYSH1V828L25ML	103
4-1879311-6	TYSH1V109J45ML	103
4-1879311-7	TYSH1V109K35ML	103
4-1879311-8	TYSH1V129J50ML	103
4-1879311-9	TYSH1V129K40ML	103

Tyco Part No.	Brand Part No.	Page No.
4-1879312-0	TYSH2C108K35ML	103
4-1879312-1	TYSH2C108L30ML	103
4-1879312-2	TYSH2C128J50ML	103
4-1879312-3	TYSH2C128K40ML	103
4-1879312-4	TYSH2C128L35ML	103
4-1879312-5	TYSH2C158K45ML	103
4-1879312-6	TYSH2C158L40ML	103
4-1879312-7	TYSH2C158K50ML	103
4-1879312-8	TYSH2C188L50ML	103
4-1879312-9	TYSH2D227H25ML	103
4-1879313-0	TYSH2G157K30ML	103
4-1879313-1	TYSH2G187H50ML	103
4-1879313-2	TYSH2G187J40ML	103
4-1879313-3	TYSH2G187J45ML	103
4-1879313-4	TYSH2G187K30ML	103
4-1879313-5	TYSH2G187K35ML	103
4-1879313-6	TYSH2G187L25ML	103
4-1879313-7	TYSH2G227J50ML	103
4-1879313-8	TYSH2G227K35ML	103
4-1879313-9	TYSH2G227K40ML	103
5-1676856-0	TYC0805A682JFT	26
5-1676856-1	TYC0805A682JFT	26
5-1676856-2	TYC0805A822JFP	26
5-1676857-0	TYC0805A682JGT	26
5-1676857-1	TYC0805A682JGT	26
5-1676857-2	TYC0805A822JGT	26
5-1676860-0	TYC1206A682JGP	26
5-1676860-1	TYC1206A103JGP	26
5-1676860-2	TYC1206A123JGP	26
5-1676860-3	TYC1206A125KDP	26
5-1676860-4	TYC1206B155KDP	26
5-1676860-5	TYC1206B185KDP	26
5-1676860-6	TYC1206B225KDP	26
5-1676903-0	TYTMB0J156MTRF	9
5-1676903-1	TYTMA0J226MTRF	9
5-1676903-2	TYTMB0J226MTRF	9
5-1676903-3	TYTMA0J336MTRF	9
5-1676903-4	TYTMB0J336MTRF	9
5-1676903-5	TYTMC0J336MTRF	9
5-1676903-6	TYTMB0J476MTRF	9
5-1676903-7	TYTMC0J476MTRF	9
5-1676903-8	TYTMB0J686MTRF	9
5-1676903-9	TYTMC0J686MTRF	9
5-1676904-0	TYTMB1V155MTRF	9
5-1676904-1	TYTMB1V225MTRF	9
5-1676904-2	TYTMB1V335MTRF	9
5-1676904-3	TYTMC1V475MTRF	9
5-1676904-4	TYTMC1V685MTRF	9
5-1676904-5	TYTMC1V106MTRF	9
5-1676904-6	TYTMD1V106MTRF	9
5-1676904-7	TYTMD1V156MTRF	9
5-1676904-8	TYTMD1V226MTRF	9
5-1676904-9	TYTMA1H154MTRF	9
5-1879055-0	TYTMA1H104KTRF	9
5-1879055-1	TYTMA1H154KTRF	9
5-1879055-2	TYTMA1H224KTRF	9
5-1879055-3	TYTMA1V104KTRF	9
5-1879055-4	TYTMA1V105KTRF	9
5-1879055-5	TYTMA1V154KTRF	9
5-1879055-6	TYTMA1V224KTRF	9
5-1879055-7	TYTMA1V334KTRF	9
5-1879055-8	TYTMA1V474KTRF	9
5-1879055-9	TYTMA1V684KTRF	9
5-1879056-0	TYTMC1D336KTRF	9
5-1879056-1	TYTMC1D685KTRF	9
5-1879056-2	TYTMC1E106KTRF	9
5-1879056-3	TYTMC1E156KTRF	9
5-1879056-4	TYTMC1E475KTRF	9
5-1879056-5	TYTMC1E685KTRF	9
5-1879056-6	TYTMC1H105KTRF	9
5-1879056-7	TYTMC1H155KTRF	9
5-1879056-8	TYTMC1H225KTRF	9
5-1879056-9	TYTMC1H474KTRF	9
5-1879057-0	TYTTP1A335KTRF	15
5-1879057-1	TYTTP1A475KTRF	15
5-1879057-2	TYTTP1A684KTRF	15
5-1879057-3	TYTTP1C105KTRF	15
5-1879057-4	TYTTP1C474KTRF	15
5-1879057-5	TYTTP1C684KTRF	15

Tyco Part No.	Brand Part No.	Page No.
5-1879057-6	TYTTP1D104KTRF	15
5-1879057-7	TYTTP1D154KTRF	15
5-1879057-8	TYTTP1D224KTRF	15
5-1879057-9	TYTTP1D334KTRF	15
5-1879058-0	TYTSD1D156KTRF	6
5-1879058-1	TYTSD1E106KTRF	6
5-1879058-2	TYTSD1H155KTRF	6
5-1879058-3	TYTSD1H225KTRF	6
5-1879058-4	TYTSD1V475KTRF	6
5-1879058-5	TYTSD1V685KTRF	6
5-1879062-0	TYTRA1D335MTRF	18
5-1879062-1	TYTRA1D475KTRF	18
5-1879062-2	TYTRA1D475MTRF	18
5-1879062-3	TYTRA1D684KTRF	18
5-1879062-4	TYTRA1D684MTRF	18
5-1879062-5	TYTRA1E105KTRF	18
5-1879062-6	TYTRA1E105MTRF	18
5-1879062-7	TYTRA1E155KTRF	18
5-1879062-8	TYTRA1E155MTRF	18
5-1879062-9	TYTRA1E474KTRF	18
5-1879063-0	TYTRB1E155MTRF	18
5-1879063-1	TYTRB1E225KTRF	18
5-1879063-2	TYTRB1E225MTRF	18
5-1879063-3	TYTRB1E335KTRF	18
5-1879063-4	TYTRB1E335MTRF	18
5-1879063-5	TYTRB1E475KTRF	18
5-1879063-6	TYTRB1E475MTRF	18
5-1879063-7	TYTRB1H154KTRF	18
5-1879063-8	TYTRB1H154MTRF	18
5-1879063-9	TYTRB1H224KTRF	18
5-1879064-0	TYTRC1H225MTRF	18
5-1879064-1	TYTRC1H474KTRF	18
5-1879064-2	TYTRC1H474MTRF	18
5-1879064-3	TYTRC1H684KTRF	18
5-1879064-4	TYTRC1H684MTRF	18
5-1879064-5	TYTRC1V106KTRF	18
5-1879064-6	TYTRC1V106MTRF	18
5-1879064-7	TYTRC1V155KTRF	18
5-1879064-8	TYTRC1V155MTRF	18
5-1879064-9	TYTRC1V225KTRF	18
5-1879065-0	TYTRP0J106KTRF	18
5-1879065-1	TYTRP0J106MTRF	18
5-1879065-2	TYTRP0J106KTRF	18
5-1879065-3	TYTRP0J106MTRF	18
5-1879065-4	TYTRP0J685MTRF	18
5-1879065-5	TYTRP1A475MTRF	18
5-1879065-6	TYTRP0J685KTRF	18
5-1879065-7	TYTRP1E337H10MTR	36
5-1879290-1	TYEV1E477H10MTR	36
5-1879290-2	TYEV1V475D55MTR	36
5-1879290-3	TYEV1V106D55MTR	36
5-1879290-4	TYEV1V106E55MTR	36
5-1879290-5	TYEV1V226E55MTR	36
5-1879290-6	TYEV1V226F55MTR	36
5-1879290-7	TYEV1V336F55MTR	36
5-1879290-8	TYEV1V336G68MTR	36
5-1879290-9	TYEV1V476F55MTR	36
5-1879291-0	TYEH1V227H10MTR	40
5-1879291-1	TYEH1V337H10MTR	40
5-1879291-2	TYEH1H104D55MTR	40
5-1879291-3	TYEH1H224D55MTR	40
5-1879291-4	TYEH1H334D55MTR	40
5-1879291-5	TYEH1H474D55MTR	40
5-1879291-6	TYEH1H105D55MTR	40
5-1879291-7	TYEH1H225D55MTR	40
5-1879291-8	TYEH1H335D55MTR	40
5-1879291-9	TYEH1H475E55MTR	40
5-1879292-0	TYEL1H107H10MTR	46
5-1879295-0	TYAV1E688G42ML	79
5-1879295-1	TYAV1E109H43ML	79
5-1879295-2	TYAV1V106A12ML	79
5-1879295-3	TYAV1V226B13ML	79
5-1879295-4	TYAV1V336B13ML	79
5-1879295-5	TYAV1V476B13ML	79
5-1879295-6	TYAV1V107C16ML	79
5-1879295-7	TYAV1V227D17ML	79
5-1879295-8	TYAV1V337D21ML	79
5-1879295-9	TYAV1V477E22ML	79
5-1879296-0	TYAV2E225C16ML	79

Tyco Part No.	Brand Part No.	Page No.
5-1879296-1	TYAV2E335C21ML	79
5-1879296-2	TYAV2E475D17ML	79
5-1879296-3	TYAV2E106D21ML	79
5-1879296-4	TYAV2E226E27ML	79
5-1879296-5	TYAV2E336F28ML	79
5-1879296-6	TYAV2E476F33ML	79
5-1879296-7	TYAV2E107F42ML	79
5-1879296-8	TYAV2E227H43ML	79
5-1879296-9	TYAV2V105C16ML	79
5-1879297-0	TYAH1V477E22ML	85
5-1879297-1	TYAH1V108E27ML	85
5-1879297-2	TYAH1V228F33ML	85
5-1879297-3	TYAH1V477E22ML	85
5-1879297-4	TYAH1V478H43ML	85
5-1879297-5	TYAH1H104A12ML	85
5-1879297-6	TYAH1H224A12ML	85
5-1879297-7	TYAH1H334A12ML	85
5-1879297-8	TYAH1H474A12ML	85
5-1879297-9	TYAH1H105A12ML	85
5-1879298-0	TYAH2V226E27ML	85
5-1879298-1	TYAH2V336F33ML	85
5-1879298-2	TYAH2V476F42ML	85
5-1879298-3	TYAH2V107H43ML	85
5-1879298-4	TYAH2G105C16ML	85
5-1879298-5	TYAH2G225D17ML	85
5-1879298-6	TYAH2G335D17ML	85
5-1879298-7	TYAH2G475D26ML	85
5-1879298-8	TYAH2G106E22ML	85
5-1879298-9	TYAH2G226F33ML	85
5-1879299-0	TYRV1E227C11ML	53
5-1879299-1	TYRV1E337C11ML	

Tyco Electronics to Brand Part Number Index

Tyco Part No.	Brand Part No.	Page No.
5-1879304-2	TYRE1V477D20ML	67
5-1879304-3	TYRE1V567D25ML	67
5-1879304-4	TYRE1V687D30ML	67
5-1879304-5	TYRE1V687E20ML	67
5-1879304-6	TYRE1V108E25ML	67
5-1879304-7	TYRE1V128E30ML	67
5-1879304-8	TYRE1V128F20ML	67
5-1879304-9	TYRE1V158E35ML	67
5-1879305-0	TYRE2A476C20ML	67
5-1879305-1	TYRE2A476D16ML	67
5-1879305-2	TYRE2A686D20ML	67
5-1879305-3	TYRE2A826D25ML	67
5-1879305-4	TYRE2A107MTRF	67
5-1879305-5	TYRE2A157E25ML	67
5-1879305-6	TYRE2A187E30ML	67
5-1879305-7	TYRE2A187F20ML	67
5-1879305-8	TYRE2A227F25ML	67
5-1879305-9	TYRE2A227G20ML	67
5-1879307-0	TYSV1V159L35ML	92
5-1879307-1	TYSV1V189K45ML	92
5-1879307-2	TYSV1V189L40ML	92
5-1879307-3	TYSV1V212L45ML	92
5-1879307-4	TYSV1H228H25ML	92
5-1879307-5	TYSV1H278H30ML	92
5-1879307-6	TYSV1H338H30ML	92
5-1879307-7	TYSV1H338J25ML	92
5-1879307-8	TYSV1H398H35ML	92
5-1879307-9	TYSV1H398J30ML	92
5-1879308-0	TYSV2C108K35ML	92
5-1879308-1	TYSV2C108L30ML	92
5-1879308-2	TYSV2C128L45ML	92
5-1879308-3	TYSV2C128J50ML	92
5-1879308-4	TYSV2C128K35ML	92
5-1879308-5	TYSV2C128L30ML	92
5-1879308-6	TYSV2C158K40ML	92
5-1879308-7	TYSV2C158K45ML	92
5-1879308-8	TYSV2C158L35ML	92
5-1879308-9	TYSV2C188K45ML	92
5-1879309-0	TYSV2V227J35ML	92
5-1879309-1	TYSV2V227J40ML	92
5-1879309-2	TYSV2V227K25ML	92
5-1879309-3	TYSV2V227K30ML	92
5-1879309-4	TYSV2V277H45ML	92
5-1879309-5	TYSV2V277J35ML	92
5-1879309-6	TYSV2V277J40ML	92
5-1879309-7	TYSV2V277K30ML	92
5-1879309-8	TYSV2V277K35ML	92
5-1879309-9	TYSV2V277L25ML	92
5-1879310-0	TYSV2W397K50ML	92
5-1879310-1	TYSV2W397L45ML	92
5-1879310-2	TYSV2W477L50ML	92
5-1879310-3	TYSV2H568H25ML	92
5-1879310-4	TYSV2H686H30ML	92
5-1879310-5	TYSV2H826H35ML	92
5-1879310-6	TYSV2H826J30ML	92
5-1879310-7	TYSV2H107H40ML	92
5-1879310-8	TYSV2H107J35ML	92
5-1879310-9	TYSV2H127H45ML	92
5-1879311-0	TYSV1V129L30ML	103
5-1879311-1	TYSV1V159K45ML	103
5-1879311-2	TYSV1V159L35ML	103
5-1879311-3	TYSV1V189L40ML	103
5-1879311-4	TYSV1V229L50ML	103
5-1879311-5	TYSV1H188H25ML	103
5-1879311-6	TYSV1H228H25ML	103
5-1879311-7	TYSV1H278H30ML	103
5-1879311-8	TYSV1H278J25ML	103
5-1879311-9	TYSV1H338H35ML	103
5-1879312-0	TYSH2D227H25ML	103
5-1879312-1	TYSH2D227J25ML	103
5-1879312-2	TYSH2D337H30ML	103
5-1879312-3	TYSH2D337J25ML	103
5-1879312-4	TYSH2D397H35ML	103
5-1879312-5	TYSH2D397K25ML	103
5-1879312-6	TYSH2D477H40ML	103
5-1879312-7	TYSH2D477J30ML	103
5-1879312-8	TYSH2D477J35ML	103
5-1879312-9	TYSH2D477K25ML	103
5-1879313-0	TYSH2G227L30ML	103
5-1879313-1	TYSH2G277J50ML	103
5-1879313-2	TYSH2G277K40ML	103

Tyco Part No.	Brand Part No.	Page No.
5-1879313-3	TYSH2G277K45ML	103
5-1879313-4	TYSH2G277L35ML	103
5-1879313-5	TYSH2G337K45ML	103
5-1879313-6	TYSH2G337L40ML	103
5-1879313-7	TYSH2G397K50ML	103
5-1879313-8	TYSH2G397L45ML	103
5-1879313-9	TYSH2G477L50ML	103
6-1676903-0	TYTMD0J686MTRF	9
6-1676903-1	TYTMB0J107MTRF	9
6-1676903-2	TYTMC0J107MTRF	9
6-1676903-3	TYTMD0J107MTRF	9
6-1676903-4	TYTMC0J157MTRF	9
6-1676903-5	TYTMD0J157MTRF	9
6-1676903-6	TYTMD0J227MTRF	9
6-1676903-7	TYTMD0J337MTRF	9
6-1676903-8	TYTMA1A225MTRF	9
6-1676903-9	TYTMA1A335MTRF	9
6-1676904-0	TYTMA1H224MTRF	9
6-1676904-1	TYTMB1H474MTRF	9
6-1676904-2	TYTMB1H684MTRF	9
6-1676904-3	TYTMC1H155MTRF	9
6-1676904-4	TYTMC1H225MTRF	9
6-1676904-5	TYTMD1H335MTRF	9
6-1676904-6	TYTMD1H475MTRF	9
6-1676904-7	TYTMA1C105MTRF	9
6-1676904-8	TYTMA1D684MTRF	9
6-1676904-9	TYTMA1E474MTRF	9
6-1879055-0	TYTMB0E107KTRF	9
6-1879055-1	TYTMB0E157KTRF	9
6-1879055-2	TYTMB0E226KTRF	9
6-1879055-3	TYTMB0E336KTRF	9
6-1879055-4	TYTMB0E476KTRF	9
6-1879055-5	TYTMB0E686KTRF	9
6-1879055-6	TYTMB0G107KTRF	9
6-1879055-7	TYTMB0G156KTRF	9
6-1879055-8	TYTMB0G226KTRF	9
6-1879055-9	TYTMB0G336KTRF	9
6-1879056-0	TYTMC1H368KTRF	9
6-1879056-1	TYTMC1V106KTRF	9
6-1879056-2	TYTMC1V155KTRF	9
6-1879056-3	TYTMC1V225KTRF	9
6-1879056-4	TYTMC1V335KTRF	9
6-1879056-5	TYTMC1V475KTRF	9
6-1879056-6	TYTMC1V685KTRF	9
6-1879056-7	TYTMD0E157KTRF	9
6-1879056-8	TYTMD0E227KTRF	9
6-1879056-9	TYTMD0E337KTRF	9
6-1879057-0	TYTTP1D474KTRF	15
6-1879057-1	TYTTP1D684KTRF	15
6-1879057-2	TYTTP1E473KTRF	15
6-1879057-3	TYTTP1E683KTRF	15
6-1879057-4	TYTRB0J106KTRF	18
6-1879057-5	TYTRB0J156KTRF	18
6-1879057-6	TYTRB0J226KTRF	18
6-1879057-7	TYTRB1A106KTRF	18
6-1879057-8	TYTRB1A156KTRF	18
6-1879057-9	TYTRB1C106KTRF	18
6-1879058-1	TYTME1A157KTRF	9
6-1879058-2	TYTME1A157MTRF	9
6-1879058-3	TYTME1C107KTRF	9
6-1879058-4	TYTME1C107MTRF	9
6-1879058-5	TYTME1C157KTRF	9
6-1879058-6	TYTME1C157MTRF	9
6-1879058-7	TYTME1D336KTRF	9
6-1879058-8	TYTME1D336MTRF	9
6-1879058-9	TYTME1D476KTRF	9
6-1879062-0	TYTRA1E474MTRF	18
6-1879062-1	TYTRA1E684KTRF	18
6-1879062-2	TYTRA1E684MTRF	18
6-1879062-3	TYTRA1H104KTRF	18
6-1879062-4	TYTRA1H104MTRF	18
6-1879062-5	TYTRA1H154KTRF	18
6-1879062-6	TYTRA1H154MTRF	18
6-1879062-7	TYTRA1V104KTRF	18
6-1879062-8	TYTRA1V104MTRF	18
6-1879062-9	TYTRA1V105KTRF	18
6-1879063-0	TYTRB1H224MTRF	18
6-1879063-1	TYTRB1H334KTRF	18
6-1879063-2	TYTRB1H334MTRF	18
6-1879063-3	TYTRB1H474KTRF	18
6-1879063-4	TYTRB1H474MTRF	18

Tyco Part No.	Brand Part No.	Page No.
6-1879063-5	TYTRB1H684KTRF	18
6-1879063-6	TYTRB1H684MTRF	18
6-1879063-7	TYTRB1V105KTRF	18
6-1879063-8	TYTRB1V105MTRF	18
6-1879063-9	TYTRB1V155KTRF	18
6-1879064-0	TYTRC1V225MTRF	18
6-1879064-1	TYTRC1V335KTRF	18
6-1879064-2	TYTRC1V335MTRF	18
6-1879064-3	TYTRC1V475KTRF	18
6-1879064-4	TYTRC1V475MTRF	18
6-1879064-5	TYTRC1V685KTRF	18
6-1879064-6	TYTRC1V685MTRF	18
6-1879064-7	TYEV1V476G68MTR	36
6-1879290-1	TYEV1V107F80MTR	36
6-1879290-2	TYEV1V107G10MTR	36
6-1879290-3	TYEV1V227G10MTR	36
6-1879290-4	TYEV1V227H10MTR	36
6-1879290-5	TYEV1V337H10MTR	36
6-1879290-6	TYEV1H104D55MTR	36
6-1879290-7	TYEV1H224D55MTR	36
6-1879290-8	TYEV1H334D55MTR	36
6-1879290-9	TYEV1H474D55MTR	36
6-1879291-0	TYEH1H106F55MTR	40
6-1879291-1	TYEH1H226G68MTR	40
6-1879291-2	TYEH1H336F80MTR	40
6-1879291-3	TYEH1H336G10MTR	40
6-1879291-4	TYEH1H476F80MTR	40
6-1879291-5	TYEH1H476G10MTR	40
6-1879291-6	TYEH1H107G10MTR	40
6-1879291-7	TYEH1H107H10MTR	40
6-1879291-8	TYEH1H227H10MTR	40
6-1879291-9	TYEH1J226G10MTR	40
6-1879295-0	TYAV1V108E27ML	79
6-1879295-1	TYAV1V228F33ML	79
6-1879295-2	TYAV1V338G36ML	79
6-1879295-3	TYAV1V478H43ML	79
6-1879295-4	TYAV1V688H43ML	79
6-1879295-5	TYAV1V109J52ML	79
6-1879295-6	TYAV1H104A12ML	79
6-1879295-7	TYAV1H224A12ML	79
6-1879295-8	TYAV1H334A12ML	79
6-1879295-9	TYAV1H474A12ML	79
6-1879296-0	TYAV2V225C11ML	79
6-1879296-1	TYAV2V335C21ML	79
6-1879296-2	TYAV2V475D21ML	79
6-1879296-3	TYAV2V106E22ML	79
6-1879296-4	TYAV2V226E27ML	79
6-1879296-5	TYAV2V336F33ML	79
6-1879296-6	TYAV2V476F42ML	79
6-1879296-7	TYAV2V107H43ML	79
6-1879296-8	TYAV2G105C16ML	79
6-1879296-9	TYAV2G225D17ML	79
6-1879297-0	TYAH1H225A12ML	85
6-1879297-1	TYAH1H335A12ML	85
6-1879297-2	TYAH1H475A12ML	85
6-1879297-3	TYAH1H106A12ML	85
6-1879297-4	TYAH1H226B13ML	85
6-1879297-5	TYAH1H336B13ML	85
6-1879297-6	TYAH1H476C13ML	85
6-1879297-7	TYAH1H107D17ML	85
6-1879297-8	TYAH1H227D21ML	85
6-1879297-9	TYAH1H337E22ML	85
6-1879298-0	TYAH2G336F42ML	85
6-1879298-1	TYAH2G476G42ML	85
6-1879298-2	TYAH2G107J43ML	85
6-1879298-3	TYAH2W105C16ML	85
6-1879298-4	TYAH2W225D21ML	85
6-1879298-5	TYAH2W335D21ML	85
6-1879298-6	TYAH2W475D26ML	85
6-1879298-7	TYAH2W106E27ML	85
6-1879298-8	TYAH2W226F36ML	85
6-1879298-9	TYAH2W336F42ML	85
6-1879299-0	TYRV1V475A11ML	53
6-1879299-1	TYRV1V106A11ML	53
6-1879299-2	TYRV1V226A11ML	53
6-1879299-3	TYRV1V336A11ML	53
6-1879299-4	TYRV1V476A11ML	53
6-1879299-5	TYRV1V107B11ML	53
6-1879299-6	TYRV1V227C11ML	53
6-1879299-7	TYRV1V227D12ML	53
6-1879299-8	TYRV1V337D12ML	53

Tyco Part No.	Brand Part No.	Page No.
6-1879299-9	TYRV1V477D16ML	53
6-1879300-0	TYRV2V335D12ML	53
6-1879300-1	TYRV2V475D16ML	53
6-1879300-2	TYRV2V106D20ML	53
6-1879300-3	TYRV2V226E20ML	53
6-1879300-4	TYRV2V336F25ML	53
6-1879300-5	TYRV2V476F31ML	53
6-1879300-6	TYRV2V107G40ML	53
6-1879300-7	TYRV2G105C11ML	53
6-1879300-8	TYRV2G225D12ML	53
6-1879300-9	TYRV2G335D16ML	53
6-1879301-0	TYRH1V476A11ML	60
6-1879301-1	TYRH1V107B11ML	60
6-1879301-2	TYRH1V227C11ML	60
6-1879301-3	TYRH1V227D12ML	60
6-1879301-4	TYRH1V337D12ML	60
6-1879301-5	TYRH1V477D16ML	60
6-1879301-6	TYRH1V108E20ML	60
6-1879301-7	TYRH1V228F25ML	60
6-1879301-8	TYRH1V338F35ML	60
6-1879301-9	TYRH1V478G35ML	60
6-1879302-0	TYRH2V476F31ML	60
6-1879302-1	TYRH2V107G40ML	60
6-1879302-2	TYRH2G105C11ML	60
6-1879302-3	TYRH2G225D12ML	60
6-1879302-4	TYRH2G335D16ML	60
6-1879302-5	TYRH2G475D20ML	60
6-1879302-6		

Tyco Electronics to Brand Part Number Index

Tyco Part No.	Brand Part No.	Page No.
6-1879309-4	TYSV2V337K40ML	92
6-1879309-5	TYSV2V337L30ML	92
6-1879309-6	TYSV2V397J45ML	92
6-1879309-7	TYSV2V397K35ML	92
6-1879309-8	TYSV2V397K40ML	92
6-1879309-9	TYSV2V397L30ML	92
6-1879310-0	TYSV2H127J35ML	92
6-1879310-1	TYSV2H127K30ML	92
6-1879310-2	TYSV2H157J40ML	92
6-1879310-3	TYSV2H157K35ML	92
6-1879310-4	TYSV2H157L30ML	92
6-1879310-5	TYSV2H187J50ML	92
6-1879310-6	TYSV2H187K40ML	92
6-1879310-7	TYSV2H187L30ML	92
6-1879310-8	TYSV2H227K45ML	92
6-1879310-9	TYSV2H227L35ML	92
6-1879311-0	TYSH1H338J35ML	103
6-1879311-1	TYSH1H398H40ML	103
6-1879311-2	TYSH1H398J35ML	103
6-1879311-3	TYSH1H398K25ML	103
6-1879311-4	TYSH1H478H45ML	103
6-1879311-5	TYSH1H478J35ML	103
6-1879311-6	TYSH1H478L25ML	103
6-1879311-7	TYSH1H568H50ML	103
6-1879311-8	TYSH1H568J40ML	103
6-1879311-9	TYSH1H568K35ML	103
6-1879312-0	TYSH2D567H45ML	103
6-1879312-1	TYSH2D567J35ML	103
6-1879312-2	TYSH2D567K30ML	103
6-1879312-3	TYSH2D687H50ML	103
6-1879312-4	TYSH2D687J40ML	103
6-1879312-5	TYSH2D687K35ML	103
6-1879312-6	TYSH2D687L25ML	103
6-1879312-7	TYSH2D827J50ML	103
6-1879312-8	TYSH2D827K40ML	103
6-1879312-9	TYSH2D827L35ML	103
6-1879313-0	TYSH2W566H25ML	103
6-1879313-1	TYSH2W686H40ML	103
6-1879313-2	TYSH2W686J25ML	103
6-1879313-3	TYSH2W826H35ML	103
6-1879313-4	TYSH2W107H40ML	103
6-1879313-5	TYSH2W107J30ML	103
6-1879313-6	TYSH2W107K25ML	103
6-1879313-7	TYSH2W127H45ML	103
6-1879313-8	TYSH2W127J35ML	103
6-1879313-9	TYSH2W157H50ML	103
7-1676903-0	TYTMA1A475MTRF	9
7-1676903-1	TYTMA1A685MTRF	9
7-1676903-2	TYTMB1A685MTRF	9
7-1676903-3	TYTMA1A156MTRF	9
7-1676903-4	TYTMA1A106MTRF	9
7-1676903-5	TYTMA1A156MTRF	9
7-1676903-6	TYTMA1A156MTRF	9
7-1676903-7	TYTMB1A226MTRF	9
7-1676903-8	TYTMC1A226MTRF	9
7-1676903-9	TYTMB1A336MTRF	9
7-1676904-1	TYTMA1H104MTRF	9
7-1676904-2	TYTMA1V104MTRF	9
7-1676904-3	TYTMA1V154MTRF	9
7-1676904-4	TYTMA1V224MTRF	9
7-1676904-5	TYTMA1V334MTRF	9
7-1676904-6	TYTMB1C335MTRF	9
7-1676904-7	TYTMB1D155MTRF	9
7-1879055-0	TYTMB0G476KTRF	9
7-1879055-1	TYTMB0G686KTRF	9
7-1879055-2	TYTMB0J106KTRF	9
7-1879055-3	TYTMB0J107KTRF	9
7-1879055-4	TYTMB0J156KTRF	9
7-1879055-5	TYTMB0J226KTRF	9
7-1879055-6	TYTMB0J336KTRF	9
7-1879055-7	TYTMB0J476KTRF	9
7-1879055-8	TYTMB0J686KTRF	9
7-1879055-9	TYTMB1A106KTRF	9
7-1879056-0	TYTMD0E477KTRF	9
7-1879056-1	TYTMD0G107KTRF	9
7-1879056-2	TYTMD0G157KTRF	9
7-1879056-3	TYTMD0G227KTRF	9
7-1879056-4	TYTMD0G337KTRF	9
7-1879056-5	TYTMD0G477KTRF	9
7-1879056-6	TYTMD0J107KTRF	9
7-1879056-7	TYTMD0J157KTRF	9

Tyco Part No.	Brand Part No.	Page No.
7-1879056-8	TYTMD0J227KTRF	9
7-1879056-9	TYTMD0J337KTRF	9
7-1879057-0	TYTRC0J336KTRF	18
7-1879057-1	TYTRC0J476KTRF	18
7-1879057-2	TYTRC1A226KTRF	18
7-1879057-3	TYTRC1A336KTRF	18
7-1879057-4	TYTRC1C156KTRF	18
7-1879057-5	TYTRC1C226KTRF	18
7-1879057-6	TYTRC1D106KTRF	18
7-1879057-7	TYTRC1D156KTRF	18
7-1879057-8	TYTRD0J107KTRF	18
7-1879057-9	TYTRD0J157KTRF	18
7-1879058-0	TYTME1D476MTRF	9
7-1879058-1	TYTME1E336KTRF	9
7-1879058-2	TYTME1E336MTRF	9
7-1879058-3	TYTME1E476KTRF	9
7-1879058-4	TYTME1E476MTRF	9
7-1879058-5	TYTME1H106KTRF	9
7-1879058-6	TYTME1H106MTRF	9
7-1879058-7	TYTME1H225KTRF	9
7-1879058-8	TYTME1H225MTRF	9
7-1879058-9	TYTME1H685KTRF	9
7-1879062-0	TYTRA1V105MTRF	18
7-1879062-1	TYTRA1V154KTRF	18
7-1879062-2	TYTRA1V154MTRF	18
7-1879062-3	TYTRA1V224KTRF	18
7-1879062-4	TYTRA1V224MTRF	18
7-1879062-5	TYTRA1V334KTRF	18
7-1879062-6	TYTRA1V334MTRF	18
7-1879062-7	TYTRA1V474KTRF	18
7-1879062-8	TYTRA1V474MTRF	18
7-1879062-9	TYTRA1V684KTRF	18
7-1879063-0	TYTRB1V155MTRF	18
7-1879063-1	TYTRB1V225KTRF	18
7-1879063-2	TYTRB1V225MTRF	18
7-1879063-3	TYTRB1V335KTRF	18
7-1879063-4	TYTRB1V335MTRF	18
7-1879063-5	TYTRB1V474KTRF	18
7-1879063-6	TYTRB1V474MTRF	18
7-1879063-7	TYTRB1V684KTRF	18
7-1879063-8	TYTRB1V684MTRF	18
7-1879290-0	TYEV1H105D55MTR	36
7-1879290-1	TYEV1H225D55MTR	36
7-1879290-2	TYEV1H335D55MTR	36
7-1879290-3	TYEV1H475D55MTR	36
7-1879290-4	TYEV1H106E55MTR	36
7-1879290-5	TYEV1H106F55MTR	36
7-1879290-6	TYEV1H226F55MTR	36
7-1879290-7	TYEV1H226G68MTR	36
7-1879290-8	TYEV1H336F80MTR	36
7-1879291-0	TYEH1J336H10MTR	40
7-1879291-1	TYEH1J476H10MTR	40
7-1879291-2	TYEH1J476H10MTR	40
7-1879291-3	TYEH2A106G10MTR	40
7-1879291-4	TYEH2A226G10MTR	40
7-1879291-5	TYEH2A226H10MTR	40
7-1879291-6	TYEH2A336H10MTR	40
7-1879291-7	TYEH2A336H10MTR	40
7-1879291-8	TYEH2A336H10MTR	40
7-1879291-9	TYAV1H105A12ML	79
7-1879295-1	TYAV1H225A12ML	79
7-1879295-2	TYAV1H335A12ML	79
7-1879295-3	TYAV1H475A12ML	79
7-1879295-4	TYAV1H106A12ML	79
7-1879295-5	TYAV1H226B13ML	79
7-1879295-6	TYAV1H336B13ML	79
7-1879295-7	TYAV1H476C13ML	79
7-1879295-8	TYAV1H107D17ML	79
7-1879295-9	TYAV1H227D21ML	79
7-1879296-0	TYAV2G335D17ML	79
7-1879296-1	TYAV2G475D22ML	79
7-1879296-2	TYAV2G106E26ML	79
7-1879296-3	TYAV2G226F33ML	79
7-1879296-4	TYAV2G336F36ML	79
7-1879296-5	TYAV2G476G42ML	79
7-1879296-6	TYAV2G107J43ML	79
7-1879296-7	TYAV2W105C16ML	79
7-1879296-8	TYAV2W225D21ML	79
7-1879296-9	TYAV2W335D21ML	79
7-1879297-0	TYAH1H477E22ML	85
7-1879297-1	TYAH1H108F33ML	85
7-1879297-2	TYAH1H228G36ML	85

Tyco Part No.	Brand Part No.	Page No.
7-1879297-3	TYAH1H338H43ML	85
7-1879297-4	TYAH1H478J43ML	85
7-1879297-5	TYAH1J104A12ML	85
7-1879297-6	TYAH1J224A12ML	85
7-1879297-7	TYAH1J334A12ML	85
7-1879297-8	TYAH1J474A12ML	85
7-1879297-9	TYAH1J105A12ML	85
7-1879298-0	TYAH2W476G42ML	85
7-1879298-1	TYAH2W107J52ML	85
7-1879298-2	TYRV1V108E20ML	53
7-1879298-3	TYRV1V228F25ML	53
7-1879298-4	TYRV1V338F35ML	53
7-1879298-5	TYRV1V478G35ML	53
7-1879298-6	TYRV1H104A11ML	53
7-1879298-7	TYRV1H224A11ML	53
7-1879298-8	TYRV1H334A11ML	53
7-1879298-9	TYRV1H474A11ML	53
7-1879298-0	TYRV1H105A11ML	53
7-1879298-1	TYRV1H225A11ML	53
7-1879298-2	TYRV2G475D20ML	53
7-1879298-3	TYRV2G106E20ML	53
7-1879298-4	TYRV2G226E25ML	53
7-1879298-5	TYRV2G226F25ML	53
7-1879298-6	TYRV2G336F25ML	53
7-1879298-7	TYRV2G476F31ML	53
7-1879298-8	TYRV2G107H40ML	53
7-1879298-9	TYRV2W105C11ML	53
7-1879299-0	TYRV2W225D12ML	53
7-1879299-1	TYRV2W335D16ML	53
7-1879299-2	TYRH1H104A11ML	60
7-1879299-3	TYRH1H224A11ML	60
7-1879299-4	TYRH1H334A11ML	60
7-1879299-5	TYRH1H474A11ML	60
7-1879299-6	TYRH1H105A11ML	60
7-1879299-7	TYRH1H225A11ML	60
7-1879299-8	TYRH1H335A11ML	60
7-1879299-9	TYRH1H475A11ML	60
7-1879300-0	TYRH1H106A11ML	60
7-1879300-1	TYRH1H226A11ML	60
7-1879300-2	TYRH2G476F35ML	60
7-1879300-3	TYRH2G107H40ML	60
7-1879300-4	TYRH2W105C11ML	60
7-1879300-5	TYRH2W225D12ML	60
7-1879300-6	TYRH2W335D16ML	60
7-1879300-7	TYRH2H106A11ML	60
7-1879300-8	TYRH2H226A11ML	60
7-1879300-9	TYRH2G476F35ML	60
7-1879301-0	TYRH2G107H40ML	60
7-1879301-1	TYRE1C476A11ML	67
7-1879301-2	TYRE1C566A11ML	67
7-1879301-3	TYRE1C107B11ML	67
7-1879301-4	TYRE1C127B11ML	67
7-1879301-5	TYRE1C157B11ML	67
7-1879301-6	TYRE1C187B15ML	67
7-1879301-7	TYRE1C227C11ML	67
7-1879301-8	TYRE1C337C11ML	67
7-1879301-9	TYRE1C477C15ML	67
7-1879302-0	TYRE1H106A11ML	67
7-1879302-1	TYRE1H186A11ML	67
7-1879302-2	TYRE1H226A11ML	67
7-1879302-3	TYRE1H336B11ML	67
7-1879302-4	TYRE1H476B11ML	67
7-1879302-5	TYRE1H566B15ML	67
7-1879302-6	TYRE1H826C11ML	67
7-1879302-7	TYRE1H107C11ML	67
7-1879302-8	TYRE1H127C15ML	67
7-1879302-9	TYRE1H127D12ML	67
7-1879303-0	TYSV1H828K35ML	92
7-1879303-1	TYSV1H828L30ML	92
7-1879303-2	TYSV1H109K40ML	92
7-1879303-3	TYSV1H109L35ML	92
7-1879303-4	TYSV1H129K50ML	92
7-1879303-5	TYSV1H159L45ML	92
7-1879303-6	TYSV1H188H25ML	92
7-1879303-7	TYSV1J228H30ML	92
7-1879303-8	TYSV1J228J35ML	92
7-1879303-9	TYSV2D477H35ML	92
7-1879304-0	TYSV2D477J30ML	92

Tyco Part No.	Brand Part No.	Page No.
7-1879308-2	TYSV2D477K25ML	92
7-1879308-3	TYSV2D567H40ML	92
7-1879308-4	TYSV2D567J30ML	92
7-1879308-5	TYSV2D567K25ML	92
7-1879308-6	TYSV2D687H45ML	92
7-1879308-7	TYSV2D687J35ML	92
7-1879308-8	TYSV2D687K30ML	92
7-1879308-9	TYSV2D827H50ML	92
7-1879309-0	TYSV2V397L35ML	92
7-1879309-1	TYSV2V477K40ML	92
7-1879309-2	TYSV2V477K45ML	92
7-1879309-3	TYSV2V477L35ML	92
7-1879309-4	TYSV2V477L40ML	92
7-1879309-5	TYSV2V567K45ML	92
7-1879309-6	TYSV2V567L35ML	92
7-1879309-7	TYSV2V567L40ML	92
7-1879309-8	TYSV2V687L45ML	92
7-1879309-9	TYSV2G686H25ML	92
7-1879310-0	TYSH2H277L40ML	92
7-1879310-1	TYSH2H337L45ML	92
7-1879310-2	TYSH1H688J50ML	103
7-1879310-3	TYSH1H688K40ML	103
7-1879310-4	TYSH1H688L30ML	103
7-1879310-5	TYSH1H828K35ML	103
7-1879310-6	TYSH1H828L30ML	103
7-1879310-7	TYSH1H828J50ML	103
7-1879310-8	TYSH1H828K40ML	103
7-1879310-9	TYSH1H109L40ML	103
7-1879311-0	TYSH1H129L45ML	103
7-187		

Tyco Part No.	Brand Part No.	Page No.
8-1879056-1	TYTMD1A107KTRF	9
8-1879056-2	TYTMD1A157KTRF	9
8-1879056-3	TYTMD1A227KTRF	9
8-1879056-4	TYTMD1A336KTRF	9
8-1879056-5	TYTMD1A476KTRF	9
8-1879056-6	TYTMD1A686KTRF	9
8-1879057-0	TYTRD0J227KTRF	18
8-1879057-1	TYTRD0J337KTRF	18
8-1879057-2	TYTRD0J686KTRF	18
8-1879057-3	TYTRD1A107KTRF	18
8-1879057-4	TYTRD1A157KTRF	18
8-1879057-5	TYTRD1A227KTRF	18
8-1879057-6	TYTRD1A476KTRF	18
8-1879057-7	TYTRD1A686KTRF	18
8-1879057-8	TYTRD1C107KTRF	18
8-1879057-9	TYTRD1C336KTRF	18
8-1879058-0	TYTME1H685MTRF	9
8-1879058-1	TYTME1V156KTRF	9
8-1879058-2	TYTME1V156MTRF	9
8-1879058-3	TYTME1V226KTRF	9
8-1879058-4	TYTME1V226MTRF	9
8-1879058-5	TYTRA0G106KTRF	18
8-1879058-6	TYTRA0G106MTRF	18
8-1879058-7	TYTRA0G156KTRF	18
8-1879058-8	TYTRA0G156MTRF	18
8-1879058-9	TYTRA0G226KTRF	18
8-1879062-0	TYTRA1V684MTRF	18
8-1879290-0	TYEV1H336G68MTR	36
8-1879290-1	TYEV1H476F80MTR	36
8-1879290-2	TYEV1H476G10MTR	36
8-1879290-3	TYEV1H107G10MTR	36
8-1879290-4	TYEV1H107H10MTR	36
8-1879290-5	TYEV1H227H10MTR	36
8-1879295-0	TYAV1H337E22ML	79
8-1879295-1	TYAV1H477E22ML	79
8-1879295-2	TYAV1H108F33ML	79
8-1879295-3	TYAV1H228G36ML	79
8-1879295-4	TYAV1H338H43ML	79
8-1879295-5	TYAV1H478J43ML	79
8-1879295-6	TYAV1H688J52ML	79
8-1879295-8	TYAV1J104A12ML	79
8-1879295-9	TYAV1J224A12ML	79
8-1879296-0	TYAV2W475D26ML	79
8-1879296-1	TYAV2W106E27ML	79
8-1879296-2	TYAV2W226F36ML	79
8-1879296-3	TYAV2W336F42ML	79
8-1879296-4	TYAV2W476G42ML	79
8-1879296-5	TYAV2W107J52ML	79
8-1879297-0	TYAH1J225A12ML	85
8-1879297-1	TYAH1J335A12ML	85
8-1879297-2	TYAH1J475A12ML	85
8-1879297-3	TYAH1J106B13ML	85
8-1879297-4	TYAH1J226B13ML	85
8-1879297-5	TYAH1J336C13ML	85
8-1879297-6	TYAH1J476C16ML	85
8-1879297-7	TYAH1J107D17ML	85
8-1879297-8	TYAH1J227E22ML	85
8-1879297-9	TYAH1J337E22ML	85
8-1879299-0	TYRV1H335A11ML	53
8-1879299-1	TYRV1H475A11ML	53
8-1879299-2	TYRV1H106A11ML	53
8-1879299-3	TYRV1H226A11ML	53
8-1879299-4	TYRV1H336A11ML	53
8-1879299-5	TYRV1H476B11ML	53
8-1879299-6	TYRV1H107C11ML	53
8-1879299-7	TYRV1H227D12ML	53
8-1879299-8	TYRV1H337D16ML	53
8-1879299-9	TYRV1H477D20ML	53
8-1879300-0	TYRV2W475D20ML	53
8-1879300-1	TYRV2W106E20ML	53
8-1879300-2	TYRV2W226F25ML	53
8-1879300-3	TYRV2W336F31ML	53
8-1879300-4	TYRV2W476G40ML	53
8-1879300-5	TYRV2W107H45ML	53
8-1879301-0	TYRH1H336A11ML	60
8-1879301-1	TYRH1H476B11ML	60
8-1879301-2	TYRH1H107C11ML	60
8-1879301-3	TYRH1H227D16ML	60
8-1879301-4	TYRH1H337D16ML	60
8-1879301-5	TYRH1H477D20ML	60
8-1879301-6	TYRH1H108E25ML	60

Tyco Part No.	Brand Part No.	Page No.
8-1879301-7	TYRH1H228F35ML	60
8-1879301-8	TYRH1H338G35ML	60
8-1879301-9	TYRH1H478H40ML	60
8-1879302-0	TYRH2W107H45ML	60
8-1879303-0	TYRE1C477D12ML	67
8-1879303-1	TYRE1C687C20ML	67
8-1879303-2	TYRE1C687D16ML	67
8-1879303-3	TYRE1C827D20ML	67
8-1879303-4	TYRE1C108D20ML	67
8-1879303-5	TYRE1C128D25ML	67
8-1879303-6	TYRE1C158D30ML	67
8-1879303-7	TYRE1C158E20ML	67
8-1879303-8	TYRE1C228E25ML	67
8-1879303-9	TYRE1C228E30ML	67
8-1879304-0	TYRE1H157D12ML	67
8-1879304-1	TYRE1H187C20ML	67
8-1879304-2	TYRE1H187D16ML	67
8-1879304-3	TYRE1H227D16ML	67
8-1879304-4	TYRE1H227D20ML	67
8-1879304-5	TYRE1H277D25ML	67
8-1879304-6	TYRE1H337D20ML	67
8-1879304-7	TYRE1H337D30ML	67
8-1879304-8	TYRE1H397E20ML	67
8-1879304-9	TYRE1H477E20ML	67
8-1879307-0	TYSV1J278H35ML	92
8-1879307-1	TYSV1J278J30ML	92
8-1879307-2	TYSV1J338H35ML	92
8-1879307-3	TYSV1J338J30ML	92
8-1879307-4	TYSV1J338K25ML	92
8-1879307-5	TYSV1J398H45ML	92
8-1879307-6	TYSV1J398J52ML	92
8-1879307-7	TYSV1J398K30ML	92
8-1879307-8	TYSV1J478H50ML	92
8-1879307-9	TYSV1J478J40ML	92
8-1879308-0	TYSV2D827J40ML	92
8-1879308-1	TYSV2D827J45ML	92
8-1879308-2	TYSV2D827K30ML	92
8-1879308-3	TYSV2D827K35ML	92
8-1879308-4	TYSV2D827L30ML	92
8-1879308-5	TYSV2D108J45ML	92
8-1879308-6	TYSV2D108J50ML	92
8-1879308-7	TYSV2D108K35ML	92
8-1879308-8	TYSV2D108K40ML	92
8-1879308-9	TYSV2D108L30ML	92
8-1879309-0	TYSV2G826H25ML	92
8-1879309-1	TYSV2G107H30ML	92
8-1879309-2	TYSV2G127J25ML	92
8-1879309-3	TYSV2G127H30ML	92
8-1879309-4	TYSV2G127H35ML	92
8-1879309-5	TYSV2G127J25ML	92
8-1879309-6	TYSV2G157H35ML	92
8-1879309-7	TYSV2G157H40ML	92
8-1879309-8	TYSV2G157J30ML	92
8-1879309-9	TYSV2G157K25ML	92
8-1879311-0	TYSH1J188J25ML	103
8-1879311-1	TYSH1J228H35ML	103
8-1879311-2	TYSH1J228J30ML	103
8-1879311-3	TYSH1J278H40ML	103
8-1879311-4	TYSH1J278J35ML	103
8-1879311-5	TYSH1J278K25ML	103
8-1879311-6	TYSH1J338H50ML	103
8-1879311-7	TYSH1J338J40ML	103
8-1879311-8	TYSH1J338K30ML	103
8-1879311-9	TYSH1J338L25ML	103
8-1879312-0	TYSH2E277H35ML	103
8-1879312-1	TYSH2E337H40ML	103
8-1879312-2	TYSH2E337J30ML	103
8-1879312-3	TYSH2E337J35ML	103
8-1879312-4	TYSH2E397H45ML	103
8-1879312-5	TYSH2E397H50ML	103
8-1879312-6	TYSH2E397J35ML	103
8-1879312-7	TYSH2E477H50ML	103
8-1879312-8	TYSH2E477J40ML	103
8-1879313-0	TYSH2W337K50ML	103
8-1879313-1	TYSH2W337L45ML	103
8-1879313-2	TYSH2W397L50ML	103
8-1879313-3	TYSH2W477L50ML	103
9-1676903-0	TYTMA0G335MTRF	9
9-1676903-1	TYTMA0J105MTRF	9
9-1676903-2	TYTMA0J155MTRF	9
9-1676903-3	TYTMA0G336MTRF	9
9-1676903-4	TYTMC1A156MTRF	9
9-1676903-5	TYTMD1A336MTRF	9
9-1676904-0	TYTMC1E475MTRF	9
9-1676904-1	TYTMC1H105MTRF	9
9-1676904-2	TYTMC1H474MTRF	9
9-1676904-3	TYTMC1H684MTRF	9
9-1676904-4	TYTMC1V155MTRF	9
9-1676904-5	TYTMC1V225MTRF	9
9-1676904-6	TYTMC1V335MTRF	9
9-1879055-0	TYTMB1C685KTRF	9
9-1879057-0	TYTRD1C476KTRF	18
9-1879057-1	TYTRD1C868KTRF	18
9-1879058-0	TYTRA0G226MTRF	18
9-1879058-1	TYTRA0G335KTRF	18
9-1879058-2	TYTRA0G335MTRF	18
9-1879058-3	TYTRA0G475KTRF	18
9-1879058-4	TYTRA0G475MTRF	18
9-1879058-5	TYTRA0G685KTRF	18
9-1879058-6	TYTRA0G685MTRF	18
9-1879295-0	TYAV1J334A12ML	79
9-1879295-1	TYAV1J474A12ML	79
9-1879295-2	TYAV1J105A12ML	79
9-1879295-3	TYAV1J225A12ML	79
9-1879295-4	TYAV1J335A12ML	79
9-1879295-5	TYAV1J475A12ML	79
9-1879295-6	TYAV1J106B13ML	79
9-1879295-7	TYAV1J226B13ML	79
9-1879295-8	TYAV1J336C13ML	79
9-1879295-9	TYAV1J476C16ML	79
9-1879296-0	TYAH1J477E27ML	85
9-1879297-0	TYAH1J108F36ML	85
9-1879297-1	TYAH1J228H43ML	85
9-1879297-2	TYAH1J338J52ML	85
9-1879297-3	TYAH1J478J52ML	85
9-1879297-4	TYAH2A104A12ML	85
9-1879297-5	TYAH2A224A12ML	85
9-1879297-6	TYAH2A334A12ML	85
9-1879297-7	TYAH2A474A12ML	85
9-1879297-8	TYAH2A105A12ML	85
9-1879297-9	TYRH1H108E25ML	53
9-1879299-1	TYRV1H228F35ML	53
9-1879299-2	TYRV1H338G35ML	53
9-1879299-3	TYRV1H338H40ML	53
9-1879299-4	TYRV1H478H40ML	53
9-1879299-5	TYRV1H478J40ML	53
9-1879299-6	TYRV1J106A11ML	53
9-1879299-7	TYRV1J476B11ML	53
9-1879301-0	TYRH1J106A11ML	60
9-1879301-1	TYRH1J226B11ML	60
9-1879301-2	TYRH1J336B11ML	60
9-1879301-3	TYRH1J476B11ML	60
9-1879301-4	TYRH1J107D12ML	60
9-1879301-5	TYRH1J227D16ML	60
9-1879301-6	TYRH1J337D20ML	60
9-1879301-7	TYRH1J477E20ML	60
9-1879301-8	TYRH1J108F25ML	60
9-1879301-9	TYRH1J228G40ML	60
9-1879303-0	TYRE1C278F20ML	67
9-1879303-1	TYRE1C338E35ML	67
9-1879303-2	TYRE1C338F25ML	67
9-1879303-3	TYRE1C398F25ML	67
9-1879303-4	TYRE1C398G20ML	67
9-1879303-5	TYRE1C478F31ML	67
9-1879303-6	TYRE1C478G25ML	67
9-1879303-7	TYRE1C568F35ML	67
9-1879303-8	TYRE1C568G31ML	67
9-1879303-9	TYRE1C688G35ML	67
9-1879304-0	TYRE1H567E25ML	67
9-1879304-1	TYRE1H687E25ML	67
9-1879304-2	TYRE1H687F20ML	67
9-1879304-3	TYRE1H827E35ML	67
9-1879304-4	TYRE1H827G20ML	67
9-1879304-5	TYRE1H108F25ML	67
9-1879304-6	TYRE1H128F31ML	67
9-1879304-7	TYRE1H128G25ML	67

Tyco Part No.	Brand Part No.	Page No.
9-1879304-8	TYRE1H158F31ML	67
9-1879304-9	TYRE1H158F35ML	67
9-1879307-0	TYSV1J478K30ML	92
9-1879307-1	TYSV1J478L25ML	92
9-1879307-2	TYSV1J568J45ML	92
9-1879307-3	TYSV1J568K35ML	92
9-1879307-4	TYSV1J688J50ML	92
9-1879307-5	TYSV1J688K40ML	92
9-1879307-6	TYSV1J688L35ML	92
9-1879307-7	TYSV1J828K45ML	92
9-1879307-8	TYSV1J828L35ML	92
9-1879307-9	TYSV1J109K50ML	92
9-1879308-0	TYSV2D128K40ML	92
9-1879308-1	TYSV2D128K45ML	92
9-1879308-2	TYSV2D128L35ML	92
9-1879308-3	TYSV2D158K50ML	92
9-1879308-4	TYSV2D158L40ML	92
9-1879308-5	TYSV2D188L45ML	92
9-1879308-6	TYSV2D188K50ML	92
9-1879308-7	TYSV2E157H25ML	92
9-1879308-8	TYSV2E187H25ML	92
9-1879308-9	TYSV2E227H25ML	92
9-1879309-0	TYSV2G187H40ML	92
9-1879309-1	TYSV2G187H45ML	92
9-1879309-2	TYSV2G187J35ML	92
9-1879309-3	TYSV2G187K30ML	92
9-1879309-4	TYSV2G227H45ML	92
9-1879309-5	TYSV2G227H50ML	92
9-1879309-6	TYSV2G227J35ML	92
9-1879309-7	TYSV2G227J40ML	92
9-1879309-8	TYSH1J398J45ML	103
9-1879309-9	TYSH1J398K35ML	103
9-1879311-0	TYSH1J398L45ML	103
9-1879311-1	TYSH1J478K40ML	103
9-1879311-2	TYSH1J478J50ML	103
9-		

Brand Part No.	Tyco Part No.	Page No.
TYAH0J107B13ML	1879297-1	85
TYAH0J108D17ML	1879297-5	85
TYAH0J227B13ML	1879297-2	85
TYAH0J228E22ML	1879297-6	85
TYAH0J337C16ML	1879297-3	85
TYAH0J338E22ML	1879297-7	85
TYAH0J477C16ML	1879297-4	85
TYAH0J478E27ML	1879297-8	85
TYAH1A107B13ML	1-1879297-1	85
TYAH1A108D17ML	1-1879297-5	85
TYAH1A227C13ML	1-1879297-2	85
TYAH1A228E22ML	1-1879297-6	85
TYAH1A336A12ML	1879297-9	85
TYAH1A337C16ML	1-1879297-3	85
TYAH1A338E27ML	1-1879297-7	85
TYAH1A476A12ML	1-1879297-0	85
TYAH1A477C16ML	1-1879297-4	85
TYAH1A478E27ML	1-1879297-8	85
TYAH1A108D17ML	1-1879297-5	85
TYAH1C106A12ML	1-1879297-9	85
TYAH1C107B13ML	2-1879297-3	85
TYAH1C108D21ML	2-1879297-7	85
TYAH1C226A12ML	2-1879297-0	85
TYAH1C227C13ML	2-1879297-4	85
TYAH1C228E24ML	2-1879297-8	85
TYAH1C336A12ML	2-1879297-1	85
TYAH1C337C16ML	2-1879297-5	85
TYAH1C338E27ML	2-1879297-9	85
TYAH1C476B13ML	2-1879297-2	85
TYAH1C477D17ML	2-1879297-6	85
TYAH1C478E27ML	3-1879297-0	85
TYAH1E106A12ML	3-1879297-1	85
TYAH1E107C13ML	3-1879297-5	85
TYAH1E108E22ML	3-1879297-9	85
TYAH1E226A12ML	3-1879297-2	85
TYAH1E227C16ML	3-1879297-6	85
TYAH1E228E28ML	4-1879297-0	85
TYAH1E336A12ML	3-1879297-3	85
TYAH1E337D17ML	3-1879297-7	85
TYAH1E338F33ML	4-1879297-1	85
TYAH1E476B13ML	3-1879297-4	85
TYAH1E477D21ML	3-1879297-8	85
TYAH1E478E27ML	4-1879297-2	85
TYAH1H104A12ML	5-1879297-5	85
TYAH1H105A12ML	5-1879297-9	85
TYAH1H106A12ML	6-1879297-3	85
TYAH1H107D17ML	6-1879297-7	85
TYAH1H108F33ML	7-1879297-1	85
TYAH1H224A12ML	5-1879297-6	85
TYAH1H225A12ML	6-1879297-0	85
TYAH1H226B13ML	6-1879297-4	85
TYAH1H227D21ML	6-1879297-8	85
TYAH1H228G36ML	7-1879297-2	85
TYAH1H334A12ML	5-1879297-7	85
TYAH1H335A12ML	6-1879297-1	85
TYAH1H336B13ML	6-1879297-5	85
TYAH1H337E22ML	6-1879297-9	85
TYAH1H338H43ML	7-1879297-3	85
TYAH1H474A12ML	5-1879297-8	85
TYAH1H475A12ML	6-1879297-2	85
TYAH1H476C13ML	6-1879297-6	85
TYAH1H477E22ML	7-1879297-0	85
TYAH1H478J43ML	7-1879297-4	85
TYAH1J104A12ML	7-1879297-5	85
TYAH1J105A12ML	7-1879297-9	85
TYAH1J106B13ML	8-1879297-3	85
TYAH1J107D17ML	8-1879297-7	85
TYAH1J108F36ML	9-1879297-1	85
TYAH1J224A12ML	7-1879297-6	85
TYAH1J225A12ML	8-1879297-0	85
TYAH1J226B13ML	8-1879297-4	85
TYAH1J227E22ML	8-1879297-8	85
TYAH1J228H43ML	9-1879297-2	85
TYAH1J334A12ML	7-1879297-7	85
TYAH1J335A12ML	8-1879297-1	85
TYAH1J336C13ML	8-1879297-5	85
TYAH1J337E22ML	8-1879297-9	85
TYAH1J338J52ML	9-1879297-3	85
TYAH1J474A12ML	7-1879297-8	85
TYAH1J475A12ML	8-1879297-2	85
TYAH1J476C16ML	8-1879297-6	85
TYAH1J477E27ML	9-1879297-0	85

Brand Part No.	Tyco Part No.	Page No.
TYAH1J478J52ML	9-1879297-4	85
TYAH1V106A12ML	4-1879297-3	85
TYAH1V107C16ML	4-1879297-7	85
TYAH1V108E27ML	5-1879297-1	85
TYAH1V226B13ML	4-1879297-4	85
TYAH1V227D17ML	4-1879297-8	85
TYAH1V228F33ML	5-1879297-2	85
TYAH1V336B13ML	4-1879297-5	85
TYAH1V337D21ML	4-1879297-9	85
TYAH1V338G36ML	5-1879297-3	85
TYAH1V476B13ML	4-1879297-6	85
TYAH1V477E22ML	5-1879297-0	85
TYAH1V478H43ML	5-1879297-4	85
TYAH2A104A12ML	9-1879297-5	85
TYAH2A105A12ML	9-1879297-9	85
TYAH2A106B13ML	1879298-4	85
TYAH2A107E22ML	1879298-8	85
TYAH2A108G42ML	1-1879298-2	85
TYAH2A224A12ML	9-1879297-6	85
TYAH2A225A12ML	1879298-1	85
TYAH2A226C16ML	1879298-5	85
TYAH2A227F28ML	1879298-9	85
TYAH2A228J52ML	1-1879298-3	85
TYAH2A334A12ML	9-1879297-7	85
TYAH2A335A12ML	1879298-2	85
TYAH2A336D17ML	1879298-6	85
TYAH2A337F33ML	1-1879298-0	85
TYAH2A474A12ML	9-1879297-8	85
TYAH2A475B13ML	1879298-3	85
TYAH2A476D21ML	1879298-7	85
TYAH2A477F36ML	1-1879298-1	85
TYAH2C105B13ML	1-1879298-4	85
TYAH2C106D17ML	1-1879298-8	85
TYAH2C107F33ML	2-1879298-2	85
TYAH2C225B13ML	1-1879298-5	85
TYAH2C226D21ML	1-1879298-9	85
TYAH2C227G42ML	2-1879298-3	85
TYAH2C335C16ML	1-1879298-6	85
TYAH2C336E22ML	2-1879298-0	85
TYAH2C337H43ML	2-1879298-4	85
TYAH2C475C16ML	1-1879298-7	85
TYAH2C476E27ML	2-1879298-1	85
TYAH2D105B13ML	2-1879298-5	85
TYAH2D106D21ML	2-1879298-9	85
TYAH2D107F36ML	3-1879298-3	85
TYAH2D225C13ML	2-1879298-6	85
TYAH2D226E22ML	3-1879298-0	85
TYAH2D227H43ML	3-1879298-4	85
TYAH2D335C16ML	2-1879298-7	85
TYAH2D336E27ML	3-1879298-1	85
TYAH2D475D17ML	2-1879298-8	85
TYAH2D476F33ML	3-1879298-2	85
TYAH2E105B13ML	3-1879298-5	85
TYAH2E106D21ML	3-1879298-9	85
TYAH2E107F42ML	4-1879298-3	85
TYAH2E225C16ML	3-1879298-6	85
TYAH2E226E27ML	4-1879298-0	85
TYAH2E227H43ML	4-1879298-4	85
TYAH2E335C21ML	3-1879298-7	85
TYAH2E336F28ML	4-1879298-1	85
TYAH2E475D17ML	3-1879298-8	85
TYAH2E476F33ML	4-1879298-2	85
TYAH2G105C16ML	5-1879298-4	85
TYAH2G106E22ML	5-1879298-8	85
TYAH2G107J43ML	6-1879298-2	85
TYAH2G225D17ML	5-1879298-5	85
TYAH2G226F33ML	5-1879298-9	85
TYAH2G335D17ML	5-1879298-6	85
TYAH2G336F42ML	6-1879298-0	85
TYAH2G475D26ML	5-1879298-7	85
TYAH2G476G42ML	6-1879298-1	85
TYAH2V105C16ML	4-1879298-5	85
TYAH2V106E22ML	4-1879298-9	85
TYAH2V107H43ML	5-1879298-3	85
TYAH2V225C21ML	4-1879298-6	85
TYAH2V226E27ML	5-1879298-0	85
TYAH2V336F33ML	5-1879298-1	85
TYAH2V475D21ML	4-1879298-8	85
TYAH2V476F42ML	5-1879298-2	85
TYAH2W105C16ML	6-1879298-3	85

Brand Part No.	Tyco Part No.	Page No.
TYAH2W106E27ML	6-1879298-7	85
TYAH2W107J52ML	7-1879298-1	85
TYAH2W225D21ML	6-1879298-4	85
TYAH2W226F36ML	6-1879298-8	85
TYAH2W335D21ML	6-1879298-5	85
TYAH2W336F42ML	6-1879298-9	85
TYAH2W475D26ML	6-1879298-6	85
TYAH2W476G42ML	7-1879298-0	85
TYAV0J107B13ML	1879295-2	79
TYAV0J108D17ML	1879295-6	79
TYAV0J109F36ML	1-1879295-1	79
TYAV0J227B13ML	1879295-3	79
TYAV0J228E22ML	1879295-7	79
TYAV0J229H43ML	1-1879295-2	79
TYAV0J337C16ML	1879295-4	79
TYAV0J338E27ML	1879295-8	79
TYAV0J476A12ML	1879295-1	79
TYAV0J477C16ML	1879295-5	79
TYAV0J478E27ML	1879295-9	79
TYAV0J688F28ML	1-1879295-0	79
TYAV1A107B13ML	1-1879295-5	79
TYAV1A108D17ML	1-1879295-9	79
TYAV1A109G36ML	2-1879295-4	79
TYAV1A227C13ML	1-1879295-6	79
TYAV1A228E22ML	2-1879295-0	79
TYAV1A336A12ML	1-1879295-3	79
TYAV1A337C16ML	1-1879295-7	79
TYAV1A338E27ML	2-1879295-1	79
TYAV1A476A12ML	1-1879295-4	79
TYAV1A477C16ML	1-1879295-8	79
TYAV1A478F28ML	2-1879295-2	79
TYAV1A688F33ML	2-1879295-3	79
TYAV1C107B13ML	2-1879295-8	79
TYAV1C108D21ML	3-1879295-2	79
TYAV1C109G42ML	3-1879295-7	79
TYAV1C226A12ML	2-1879295-5	79
TYAV1C227C13ML	2-1879295-9	79
TYAV1C228E24ML	3-1879295-3	79
TYAV1C336A12ML	2-1879295-6	79
TYAV1C337C16ML	3-1879295-0	79
TYAV1C338F28ML	3-1879295-4	79
TYAV1C476B13ML	2-1879295-7	79
TYAV1C477C16ML	3-1879295-1	79
TYAV1C478G36ML	3-1879295-5	79
TYAV1C688G36ML	3-1879295-6	79
TYAV1E106A12ML	3-1879295-8	79
TYAV1E107C13ML	4-1879295-2	79
TYAV1E108E22ML	4-1879295-6	79
TYAV1E109H43ML	5-1879295-1	79
TYAV1E226A12ML	3-1879295-9	79
TYAV1E227C16ML	4-1879295-3	79
TYAV1E228F28ML	4-1879295-7	79
TYAV1E336A12ML	4-1879295-0	79
TYAV1E337D17ML	4-1879295-4	79
TYAV1E338F33ML	4-1879295-8	79
TYAV1E476B13ML	4-1879295-1	79
TYAV1E477D21ML	4-1879295-5	79
TYAV1E478G36ML	4-1879295-9	79
TYAV1E688G42ML	5-1879295-0	79
TYAV1H104A12ML	6-1879295-6	79
TYAV1H105A12ML	7-1879295-0	79
TYAV1H106A12ML	7-1879295-4	79
TYAV1H107D17ML	7-1879295-8	79
TYAV1H108F33ML	8-1879295-2	79
TYAV1H224A12ML	6-1879295-7	79
TYAV1H225A12ML	7-1879295-1	79
TYAV1H226B13ML	7-1879295-5	79
TYAV1H227D21ML	7-1879295-9	79
TYAV1H228G36ML	8-1879295-3	79
TYAV1H334A12ML	6-1879295-6	79
TYAV1H335A12ML	7-1879295-2	79
TYAV1H336B13ML	7-1879295-6	79
TYAV1H337E22ML	8-1879295-0	79
TYAV1H338H43ML	8-1879295-4	79
TYAV1H474A12ML	6-1879295-9	79
TYAV1H475A12ML	7-1879295-3	79
TYAV1H476C13ML	7-1879295-7	79
TYAV1H477E22ML	8-1879295-1	79
TYAV1H478J43ML	8-1879295-5	79
TYAV1J104A12ML	7-1879295-8	79
TYAV1J105A12ML	8-1879295-2	79
TYAV1J106B13ML	8-1879295-6	79
TYAV1J107D17ML	8-1879295-0	79
TYAV1J108F36ML	9-1879295-4	79
TYAV1J224A12ML	7-1879295-7	79
TYAV1J225A12ML	8-1879295-1	79
TYAV1J226B13ML	8-1879295-5	79
TYAV1J227E22ML	8-1879295-9	79
TYAV1J228H43ML	9-1879295-3	79
TYAV1J334A12ML	7-1879295-7	79
TYAV1J335A12ML	8-1879295-1	79
TYAV1J336C13ML	8-1879295-5	79
TYAV1J337E22ML	8-1879295-9	79
TYAV1J338J52ML	9-1879295-3	79
TYAV1J474A12ML	7-1879295-8	79
TYAV1J475A12ML	8-1879295-2	79
TYAV1J476C16ML	8-1879295-6	79
TYAV1J477E27ML	9-1879295-0	79

Brand Part No.	Tyco Part No.	Page No.
TYAV1J105A12ML	9-1879295-2	79
TYAV1J106B13ML	9-1879295-6	79
TYAV1J107D17ML	1879296-1	79
TYAV1J108F36ML	1879296-5	79
TYAV1J224A12ML	8-1879295-9	79
TYAV1J225A12ML	9-1879295-3	79
TYAV1J226B13ML	9-1879295-7	79
TYAV1J227E22ML	1879296-2	79
TYAV1J228H43ML	1879296-6	79
TYAV1J334A12ML	9-1879295-0	79
TYAV1J335A12ML	9-1879295-4	79
TYAV1J336C13ML		

Brand Part No.	Tyco Part No.	Page No.
TYAV2E476F33ML	5-1879296-6	79
TYAV2G105C16ML	6-1879296-8	79
TYAV2G106E22ML	7-1879296-2	79
TYAV2G107J43ML	7-1879296-6	79
TYAV2G225D17ML	6-1879296-9	79
TYAV2G226F33ML	7-1879296-3	79
TYAV2G335D17ML	7-1879296-0	79
TYAV2G336F36ML	7-1879296-4	79
TYAV2G475D26ML	7-1879296-1	79
TYAV2G476G42ML	7-1879296-5	79
TYAV2V105C16ML	5-1879296-9	79
TYAV2V106E22ML	6-1879296-3	79
TYAV2V107H43ML	6-1879296-7	79
TYAV2V225C21ML	6-1879296-0	79
TYAV2V226E27ML	6-1879296-4	79
TYAV2V335C21ML	6-1879296-1	79
TYAV2V336F33ML	6-1879296-5	79
TYAV2V475D21ML	6-1879296-2	79
TYAV2V476G42ML	6-1879296-6	79
TYAV2W105C16ML	7-1879296-7	79
TYAV2W106E27ML	8-1879296-1	79
TYAV2W107J52ML	8-1879296-5	79
TYAV2W225D21ML	7-1879296-8	79
TYAV2W226F36ML	8-1879296-2	79
TYAV2W335D21ML	7-1879296-9	79
TYAV2W336F42ML	8-1879296-3	79
TYAV2W475D26ML	8-1879296-0	79
TYAV2W476G42ML	8-1879296-4	79
TYCO201A100JFT	1-1676849-7	26
TYCO201A101JFT	2-1676849-9	26
TYCO201A109JFT	1676849-5	26
TYCO201A120JFT	1-1676849-8	26
TYCO201A129JFT	1676849-6	26
TYCO201A150JFT	1-1676849-9	26
TYCO201A159JFT	1676849-7	26
TYCO201A180JFT	2-1676849-0	26
TYCO201A189JFT	1676849-8	26
TYCO201A220JFT	2-1676849-1	26
TYCO201A229JFT	1676849-9	26
TYCO201A270JFT	2-1676849-2	26
TYCO201A279JFT	1-1676849-0	26
TYCO201A330JFT	2-1676849-3	26
TYCO201A339JFT	1-1676849-1	26
TYCO201A390JFT	2-1676849-4	26
TYCO201A399JFT	1-1676849-2	26
TYCO201A470JFT	2-1676849-5	26
TYCO201A479JFT	1-1676849-3	26
TYCO201A560JFT	2-1676849-6	26
TYCO201A569JFT	1-1676849-4	26
TYCO201A680JFT	2-1676849-7	26
TYCO201A689JFT	1-1676849-5	26
TYCO201A820JFT	2-1676849-8	26
TYCO201A829JFT	1-1676849-6	26
TYCO402A100JFT	1-1676850-7	26
TYCO402A100JGT	1-1676851-7	26
TYCO402A101JFT	2-1676850-9	26
TYCO402A101JGT	2-1676851-9	26
TYCO402A109JFT	1676850-5	26
TYCO402A120JFT	1-1676850-8	26
TYCO402A120JGT	1-1676851-8	26
TYCO402A121JFT	3-1676850-0	26
TYCO402A121JGT	3-1676851-0	26
TYCO402A129JFT	1676850-6	26
TYCO402A129JGT	1676851-6	26
TYCO402A150JFT	1-1676850-9	26
TYCO402A150JGT	1-1676851-9	26
TYCO402A151JFT	3-1676850-1	26
TYCO402A151JGT	3-1676851-1	26
TYCO402A159JFT	1676850-7	26
TYCO402A159JGT	1676851-7	26
TYCO402A180JFT	2-1676850-0	26
TYCO402A180JGT	2-1676851-0	26
TYCO402A181JFT	3-1676850-2	26
TYCO402A181JGT	3-1676851-2	26
TYCO402A189JFT	1676850-8	26
TYCO402A189JGT	1676851-8	26
TYCO402A220JFT	2-1676850-1	26
TYCO402A220JGT	2-1676851-1	26
TYCO402A221JFT	3-1676850-3	26
TYCO402A221JGT	3-1676851-3	26

Brand Part No.	Tyco Part No.	Page No.
TYC0402A229JFT	1676850-9	26
TYC0402A229JGT	1676851-9	26
TYC0402A270JFT	2-1676850-2	26
TYC0402A270JGT	2-1676851-2	26
TYC0402A279JFT	1-1676850-0	26
TYC0402A279JGT	1-1676851-0	26
TYC0402A330JFT	2-1676850-3	26
TYC0402A330JGT	2-1676851-3	26
TYC0402A339JFT	1-1676850-1	26
TYC0402A339JGT	1-1676851-1	26
TYC0402A390JFT	2-1676850-4	26
TYC0402A390JGT	2-1676851-4	26
TYC0402A399JFT	1-1676850-2	26
TYC0402A399JGT	1-1676851-2	26
TYC0402A470JFT	2-1676850-5	26
TYC0402A470JGT	2-1676851-5	26
TYC0402A478JFT	1676850-1	26
TYC0402A478JGT	1676851-1	26
TYC0402A479JFT	1-1676850-3	26
TYC0402A479JGT	1-1676851-3	26
TYC0402A560JFT	2-1676850-6	26
TYC0402A560JGT	2-1676851-6	26
TYC0402A568JFT	1676850-2	26
TYC0402A568JGT	1676851-2	26
TYC0402A569JFT	1-1676850-4	26
TYC0402A569JGT	1-1676851-4	26
TYC0402A680JFT	2-1676850-7	26
TYC0402A680JGT	2-1676851-7	26
TYC0402A688JFT	1676850-3	26
TYC0402A688JGT	1676851-3	26
TYC0402A689JFT	1-1676850-5	26
TYC0402A689JGT	1-1676851-5	26
TYC0402A820JFT	2-1676850-8	26
TYC0402A820JGT	2-1676851-8	26
TYC0402A828JFT	1676850-4	26
TYC0402A828JGT	1676851-4	26
TYC0402A829JFT	1-1676850-6	26
TYC0402A829JGT	1-1676851-6	26
TYC0402B101KDT	1676864-1	26
TYC0402B101KET	1676865-1	26
TYC0402B101KFT	1676866-1	26
TYC0402B101KGT	1676867-1	26
TYC0402B102KDT	1-1676864-3	26
TYC0402B102KET	1-1676865-3	26
TYC0402B102KFT	1-1676866-3	26
TYC0402B102KGT	1-1676867-3	26
TYC0402B103KDT	2-1676864-5	26
TYC0402B103KET	2-1676865-5	26
TYC0402B103KFT	2-1676866-5	26
TYC0402B103KGT	2-1676867-5	26
TYC0402B121KDT	1676864-2	26
TYC0402B121KET	1676865-2	26
TYC0402B121KFT	1676866-2	26
TYC0402B121KGT	1676867-2	26
TYC0402B122KDT	1-1676864-4	26
TYC0402B122KET	1-1676865-4	26
TYC0402B122KFT	1-1676866-4	26
TYC0402B122KGT	1-1676867-4	26
TYC0402B123KDT	2-1676864-6	26
TYC0402B123KET	2-1676865-6	26
TYC0402B151KDT	1676864-3	26
TYC0402B151KET	1676865-3	26
TYC0402B151KFT	1676866-3	26
TYC0402B151KGT	1676867-3	26
TYC0402B152KDT	1-1676864-5	26
TYC0402B152KET	1-1676865-5	26
TYC0402B152KFT	1-1676866-5	26
TYC0402B152KGT	1-1676867-5	26
TYC0402B153KDT	2-1676864-7	26
TYC0402B153KET	2-1676865-7	26
TYC0402B181KDT	1676864-4	26
TYC0402B181KET	1676865-4	26
TYC0402B181KFT	1676866-4	26
TYC0402B181KGT	1676867-4	26
TYC0402B182KDT	1-1676864-6	26
TYC0402B182KET	1-1676865-6	26
TYC0402B182KFT	1-1676866-6	26
TYC0402B182KGT	1-1676867-6	26
TYC0402B183KDT	2-1676864-8	26
TYC0402B183KET	2-1676865-8	26
TYC0402B221KDT	1676864-4	26
TYC0402B221KET	1676865-4	26

Brand Part No.	Tyco Part No.	Page No.
TYC0402B221KFT	1676866-5	26
TYC0402B221KGT	1676867-5	26
TYC0402B222KDT	1-1676864-7	26
TYC0402B222KET	1-1676865-7	26
TYC0402B222KFT	1-1676866-7	26
TYC0402B222KGT	1-1676867-7	26
TYC0402B223KDT	2-1676864-9	26
TYC0402B223KET	2-1676865-9	26
TYC0402B271KDT	1676864-6	26
TYC0402B271KFT	1676865-6	26
TYC0402B271KGT	1676866-6	26
TYC0402B271KFT	1676867-6	26
TYC0402B272KDT	1-1676864-8	26
TYC0402B272KET	1-1676865-8	26
TYC0402B272KFT	1-1676866-8	26
TYC0402B272KGT	1-1676867-8	26
TYC0402B273KDT	3-1676864-0	26
TYC0402B273KET	3-1676865-0	26
TYC0402B273KFT	1676864-7	26
TYC0402B273KGT	1676865-7	26
TYC0402B331KFT	1676866-7	26
TYC0402B331KGT	1676867-7	26
TYC0402B332KDT	1-1676864-9	26
TYC0402B332KET	1-1676865-9	26
TYC0402B332KFT	1-1676866-9	26
TYC0402B332KGT	1-1676867-9	26
TYC0402B333KDT	3-1676864-1	26
TYC0402B333KET	3-1676865-1	26
TYC0402B333KFT	1676864-8	26
TYC0402B333KGT	1676865-8	26
TYC0402B391KFT	1676865-8	26
TYC0402B391KGT	1676867-8	26
TYC0402B392KDT	2-1676864-0	26
TYC0402B392KET	2-1676865-0	26
TYC0402B392KFT	2-1676866-0	26
TYC0402B392KGT	2-1676867-0	26
TYC0402B393KDT	3-1676864-2	26
TYC0402B393KET	3-1676865-2	26
TYC0402B471KDT	1676864-9	26
TYC0402B471KET	1676865-9	26
TYC0402B471KFT	1676866-9	26
TYC0402B471KGT	1676867-9	26
TYC0402B472KDT	2-1676864-1	26
TYC0402B472KET	2-1676865-1	26
TYC0402B472KFT	2-1676866-1	26
TYC0402B472KGT	2-1676867-1	26
TYC0402B473KDT	2-1676864-3	26
TYC0402B473KET	3-1676865-3	26
TYC0402B561KDT	1-1676864-0	26
TYC0402B561KET	1-1676865-0	26
TYC0402B561KFT	1-1676866-0	26
TYC0402B561KGT	1-1676867-0	26
TYC0402B562KDT	2-1676864-2	26
TYC0402B562KET	2-1676865-2	26
TYC0402B562KFT	2-1676866-2	26
TYC0402B562KGT	2-1676867-2	26
TYC0402B681KDT	1-1676864-1	26
TYC0402B681KET	1-1676865-1	26
TYC0402B681KFT	1-1676866-1	26
TYC0402B681KGT	1-1676867-1	26
TYC0402B682KDT	2-1676864-3	26
TYC0402B682KET	2-1676865-3	26
TYC0402B682KFT	2-1676866-3	26
TYC0402B682KGT	2-1676867-3	26
TYC0402B821KDT	1-1676864-2	26
TYC0402B821KFT	1-1676865-2	26
TYC0402B821KGT	1-1676866-2	26
TYC0402B822KDT	2-1676864-4	26
TYC0402B822KET	2-1676865-4	26
TYC0402B822KFT	2-1676866-4	26
TYC0402C104ZDT	1-1676866-3	26
TYC0402C123ZDT	1676866-2	26
TYC0402C123ZET	1676887-2	26
TYC0402C153ZDT	1676886-3	26
TYC0402C183ZDT	1676886-4	26
TYC0402C183ZET	1676887-4	26
TYC0402C223ZDT	1676886-5	26
TYC0402C223ZET	1676887-5	26
TYC0402C273ZDT	1676886-6	26

Brand Part No.	Tyco Part No.	Page No.
TYC0402C273ZET	1676887-6	26
TYC0402C333ZDT	1676886-7	26
TYC0402C333ZET	1676887-7	26
TYC0402C393ZDT	1676886-8	26
TYC0402C473ZDT	1676886-9	26
TYC0402C563ZDT	1-1676886-0	26
TYC0402C683ZDT	1-1676886-1	26
TYC0402C823ZDT	1-1676886-2	26
TYC0402D103ZET	1676890-1	26
TYC0402D103ZFT	1676891-1	26
TYC0402D104ZDT	1-1676889-3	26
TYC0402D104ZET	1-1676890-3	26
TYC0402D123ZET	1676890-2	26
TYC0402D123ZFT	1676891-2	26
TYC0402D124ZDT	1-1676889-4	26
TYC0402D124ZET	1676889-4	26
TYC0402D154ZDT	1-1676889-5	26
TYC0402D183ZDT	1676890-4	26
TYC0402D183ZFT	1676891-4	26
TYC0402D184ZDT	1-1676889-6	26
TYC0402D223ZET	1676890-5	26
TYC0402D223ZFT	1676891-5	26
TYC0402D224ZDT	1-1676889-7	26
TYC0402D273ZET	1676890-6	26
TYC0402D333ZET	1676890-7	26
TYC0402D393ZET	1676890-8	26
TYC0402D473ZET	1676890-9	26
TYC0402D563ZET	1-1676890-0	26
TYC0402D683ZET	1-1676890-1	26
TYC0402D823ZET		

Brand Part No.	Tyco Part No.	Page No.
TYC0603A270JFT	2-1676853-2	26
TYC0603A270JGT	2-1676854-2	26
TYC0603A270JHT	2-1676855-2	26
TYC0603A271JFT	3-1676853-4	26
TYC0603A271JGT	3-1676854-4	26
TYC0603A271JHT	3-1676855-4	26
TYC0603A279JFT	1-1676853-0	26
TYC0603A279JGT	1-1676854-0	26
TYC0603A279JHT	1-1676855-0	26
TYC0603A330JFT	2-1676853-3	26
TYC0603A330JGT	2-1676854-3	26
TYC0603A330JHT	2-1676855-3	26
TYC0603A331JFT	3-1676853-5	26
TYC0603A331JGT	3-1676854-5	26
TYC0603A331JHT	3-1676855-5	26
TYC0603A339JFT	1-1676853-1	26
TYC0603A339JGT	1-1676854-1	26
TYC0603A339JHT	1-1676855-1	26
TYC0603A390JFT	2-1676853-4	26
TYC0603A390JGT	2-1676854-4	26
TYC0603A390JHT	2-1676855-4	26
TYC0603A391JFT	3-1676853-6	26
TYC0603A391JGT	3-1676854-6	26
TYC0603A391JHT	3-1676855-6	26
TYC0603A399JFT	1-1676853-2	26
TYC0603A399JGT	1-1676854-2	26
TYC0603A399JHT	1-1676855-2	26
TYC0603A470JFT	2-1676853-5	26
TYC0603A470JGT	2-1676854-5	26
TYC0603A470JHT	2-1676855-5	26
TYC0603A471JFT	3-1676853-7	26
TYC0603A471JGT	3-1676854-7	26
TYC0603A471JHT	3-1676855-7	26
TYC0603A478JFT	1676853-1	26
TYC0603A478JGT	1676854-1	26
TYC0603A478JHT	1676855-1	26
TYC0603A479JFT	1-1676853-3	26
TYC0603A479JGT	1-1676854-3	26
TYC0603A479JHT	1-1676855-3	26
TYC0603A560JFT	2-1676853-6	26
TYC0603A560JGT	2-1676854-6	26
TYC0603A560JHT	2-1676855-6	26
TYC0603A561JFT	3-1676853-8	26
TYC0603A561JGT	3-1676854-8	26
TYC0603A561JHT	3-1676855-8	26
TYC0603A568JFT	1676853-2	26
TYC0603A568JGT	1676854-2	26
TYC0603A568JHT	1676855-2	26
TYC0603A569JFT	1-1676853-4	26
TYC0603A569JGT	1-1676854-4	26
TYC0603A569JHT	1-1676855-4	26
TYC0603A680JFT	2-1676853-7	26
TYC0603A680JGT	2-1676854-7	26
TYC0603A680JHT	2-1676855-7	26
TYC0603A681JFT	3-1676853-9	26
TYC0603A681JGT	3-1676854-9	26
TYC0603A681JHT	3-1676855-9	26
TYC0603A688JFT	1676853-3	26
TYC0603A688JGT	1676854-3	26
TYC0603A688JHT	1676855-3	26
TYC0603A689JFT	1-1676853-5	26
TYC0603A689JGT	1-1676854-5	26
TYC0603A689JHT	1-1676855-5	26
TYC0603A820JFT	2-1676853-8	26
TYC0603A820JGT	2-1676854-8	26
TYC0603A820JHT	2-1676855-8	26
TYC0603A821JFT	4-1676853-0	26
TYC0603A821JGT	4-1676854-0	26
TYC0603A828JFT	1676853-4	26
TYC0603A828JGT	1676854-4	26
TYC0603A828JHT	1676855-4	26
TYC0603A829JFT	1-1676853-6	26
TYC0603A829JGT	1-1676854-6	26
TYC0603A829JHT	1-1676855-6	26
TYC0603B101KFT	1676870-1	26
TYC0603B101KGT	1676871-1	26
TYC0603B102KFT	1-1676870-3	26
TYC0603B102KGT	1-1676871-3	26
TYC0603B102KHT	1-1676872-3	26
TYC0603B103KFT	2-1676870-5	26

Brand Part No.	Tyco Part No.	Page No.
TYC0603B103KGT	2-1676871-5	26
TYC0603B103KHT	2-1676872-5	26
TYC0603B104KDT	3-1676868-7	26
TYC0603B104KET	3-1676869-7	26
TYC0603B121KFT	1676870-2	26
TYC0603B121KGT	1676871-2	26
TYC0603B121KHT	1676872-2	26
TYC0603B122KFT	1-1676870-4	26
TYC0603B122KGT	1-1676871-4	26
TYC0603B122KHT	1-1676872-4	26
TYC0603B123KFT	2-1676870-6	26
TYC0603B123KGT	2-1676871-6	26
TYC0603B123KHT	2-1676872-6	26
TYC0603B124KDT	3-1676868-8	26
TYC0603B151KFT	1676870-3	26
TYC0603B151KGT	1676871-3	26
TYC0603B151KHT	1676872-3	26
TYC0603B152KFT	1-1676870-5	26
TYC0603B152KGT	1-1676871-5	26
TYC0603B152KHT	1-1676872-5	26
TYC0603B153KFT	2-1676870-7	26
TYC0603B153KGT	2-1676871-7	26
TYC0603B153KHT	2-1676872-7	26
TYC0603B154KDT	3-1676868-9	26
TYC0603B181KFT	1676870-4	26
TYC0603B181KGT	1676871-4	26
TYC0603B181KHT	1676872-4	26
TYC0603B182KFT	1-1676870-6	26
TYC0603B182KGT	1-1676871-6	26
TYC0603B182KHT	1-1676872-6	26
TYC0603B183KFT	2-1676870-8	26
TYC0603B183KGT	2-1676871-8	26
TYC0603B184KDT	4-1676868-0	26
TYC0603B221KFT	1676870-5	26
TYC0603B221KGT	1676871-5	26
TYC0603B221KHT	1676872-5	26
TYC0603B222KFT	1-1676870-7	26
TYC0603B222KGT	1-1676871-7	26
TYC0603B222KHT	1-1676872-7	26
TYC0603B223KFT	2-1676870-9	26
TYC0603B223KGT	2-1676871-9	26
TYC0603B224KDT	4-1676868-1	26
TYC0603B271KFT	1676870-6	26
TYC0603B271KGT	1676871-6	26
TYC0603B271KHT	1676872-6	26
TYC0603B272KFT	1-1676870-8	26
TYC0603B272KGT	1-1676871-8	26
TYC0603B272KHT	1-1676872-8	26
TYC0603B273KFT	3-1676870-0	26
TYC0603B273KGT	3-1676871-0	26
TYC0603B331KFT	1676870-7	26
TYC0603B331KGT	1676871-7	26
TYC0603B331KHT	1676872-7	26
TYC0603B332KFT	1-1676870-9	26
TYC0603B332KGT	1-1676871-9	26
TYC0603B332KHT	1-1676872-9	26
TYC0603B333KFT	3-1676870-1	26
TYC0603B333KGT	3-1676871-1	26
TYC0603B391KFT	1676870-8	26
TYC0603B391KGT	1676871-8	26
TYC0603B392KFT	2-1676870-0	26
TYC0603B392KGT	2-1676871-0	26
TYC0603B393KFT	3-1676871-2	26
TYC0603B471KFT	1676870-9	26
TYC0603B471KGT	1676871-9	26
TYC0603B472KFT	2-1676870-1	26
TYC0603B472KGT	2-1676871-1	26
TYC0603B472KHT	2-1676872-1	26
TYC0603B473KFT	3-1676869-3	26
TYC0603B473KGT	3-1676871-3	26
TYC0603B561KFT	1-1676870-0	26
TYC0603B561KGT	1-1676871-0	26
TYC0603B561KHT	1-1676872-0	26
TYC0603B562KFT	2-1676870-2	26
TYC0603B562KGT	2-1676871-2	26
TYC0603B562KHT	2-1676872-2	26

Brand Part No.	Tyco Part No.	Page No.
TYC0603B563KET	3-1676869-4	26
TYC0603B681KFT	1-1676870-1	26
TYC0603B681KGT	1-1676871-1	26
TYC0603B681KHT	1-1676872-1	26
TYC0603B682KFT	2-1676870-3	26
TYC0603B682KGT	2-1676871-3	26
TYC0603B682KHT	2-1676872-3	26
TYC0603B683KET	3-1676869-5	26
TYC0603B821KFT	1-1676870-2	26
TYC0603B821KGT	1-1676871-2	26
TYC0603B821KHT	1-1676872-2	26
TYC0603B822KFT	2-1676870-4	26
TYC0603B822KGT	2-1676871-4	26
TYC0603B822KHT	2-1676872-4	26
TYC0603B823KET	3-1676869-6	26
TYC0603C154ZDT	1-1676888-5	26
TYC0603C184ZDT	1-1676888-6	26
TYC0603C224ZDT	1-1676888-7	26
TYC0603C2821KGT	1-1676888-8	26
TYC0603C334ZDT	1-1676888-9	26
TYC0603C394ZDT	2-1676888-0	26
TYC0603C474ZDT	2-1676888-1	26
TYC0603D103ZFT	1676893-1	26
TYC0603D103ZGT	1676894-1	26
TYC0603D104ZET	1-1676892-3	26
TYC0603D104ZFT	1-1676893-3	26
TYC0603D104ZGT	1-1676894-3	26
TYC0603D105ZET	2-1676892-5	26
TYC0603D123ZFT	1676893-2	26
TYC0603D123ZGT	1676894-2	26
TYC0603D124ZET	1-1676892-4	26
TYC0603D153ZFT	1676893-3	26
TYC0603D153ZGT	1676894-3	26
TYC0603D154ZET	1-1676892-5	26
TYC0603D183ZFT	1676893-4	26
TYC0603D183ZGT	1676894-4	26
TYC0603D184ZET	1-1676892-6	26
TYC0603D223ZFT	1676893-5	26
TYC0603D223ZGT	1676894-5	26
TYC0603D224ZET	1-1676892-7	26
TYC0603D273ZFT	1676893-6	26
TYC0603D273ZGT	1676894-6	26
TYC0603D274ZET	1-1676892-8	26
TYC0603D333ZFT	1676893-7	26
TYC0603D333ZGT	1676894-7	26
TYC0603D334ZET	1-1676892-9	26
TYC0603D393ZFT	1676893-8	26
TYC0603D393ZGT	1676894-8	26
TYC0603D394ZET	2-1676892-0	26
TYC0603D473ZFT	1676893-9	26
TYC0603D473ZGT	1676894-9	26
TYC0603D474ZET	2-1676892-1	26
TYC0603D563ZFT	1-1676893-0	26
TYC0603D563ZGT	1-1676894-0	26
TYC0603D564ZET	2-1676892-2	26
TYC0603D683ZFT	1-1676893-1	26
TYC0603D683ZGT	1-1676894-1	26
TYC0603D684ZET	2-1676892-3	26
TYC0603D823ZFT	1-1676893-2	26
TYC0603D823ZGT	1-1676894-2	26
TYC0603D824ZET	2-1676892-4	26
TYC0805A100JFT	1-1676856-7	26
TYC0805A100JGT	1-1676857-7	26
TYC0805A100JHT	1-1676858-7	26
TYC0805A101JFT	2-1676856-9	26
TYC0805A101JGT	2-1676857-9	26
TYC0805A101JHT	2-1676858-9	26
TYC0805A102JFT	4-1676856-1	26
TYC0805A102JGT	4-1676857-1	26
TYC0805A102JHT	4-1676858-1	26
TYC0805A109JFT	1676856-5	26
TYC0805A109JGT	1676857-5	26
TYC0805A109JHT	1676858-5	26
TYC0805A109JFT	1676859-5	26
TYC0805A120JFT	1-1676856-8	26
TYC0805A120JGT	1-1676857-8	26
TYC0805A120JHT	1-1676858-8	26
TYC0805A120JFT	1-1676859-8	26
TYC0805A121JFT	3-1676856-0	26

Brand Part No.	Tyco Part No.	Page No.
TYC0805A121JGT	3-1676857-0	26
TYC0805A121JHT	3-1676858-0	26
TYC0805A121JFT	3-1676859-0	26
TYC0805A122JFT	4-1676856-2	26
TYC0805A122JGT	4-1676857-2	26
TYC0805A122JHT	4-1676858-2	26
TYC0805A129JFT	1676856-6	26
TYC0805A129JGT	1676857-6	26
TYC0805A129JHT	1676858-6	26
TYC0805A151JFT	1-1676857-2	26
TYC0805A151JGT	1-1676858-2	26
TYC0805A151JHT	1-1676859-2	26
TYC0805A151JFT	3-1676856-1	26
TYC0805A151JGT	3-1676857-1	26
TYC0805A151JHT	3-1676858-1	26
TYC0805A151JFT	3-1676859-1	26
TYC0805A152JFT	4-1676856-3	26
TYC0805A152JGT	4-1676857-3	26
TYC0805A152JHT	4-1676858-3	26
TYC0805A159JFT	1676856-7	26
TYC0805A159JGT	1676857-7	26
TYC0805A159JHT	1676858-7	26
TYC0805A159JFT	1676859-7	26
TYC0805A180JFT	2-1676856-0	26
TYC0805A180JGT	2-1676857-0	26
TYC0805A180JHT	2-1676858-0	26
TYC0805A181JFT	3-1676856-2	26
TYC0805A181JGT	3-1676857-2	26
TYC0805A181JHT	3-1676858-2	26
TYC0805A181JFT	3-1676859-2	26
TYC0805A182JFT	4-1676856-4	26
TYC0805A182JGT	4-1676857-4	26

Brand Part No.	Tyco Part No.	Page No.
TYC0805A339JHT	1-1676858-1	26
TYC0805A339JFT	1-1676859-1	26
TYC0805A390JFT	2-1676856-4	26
TYC0805A390JGT	2-1676857-4	26
TYC0805A390JHT	2-1676858-4	26
TYC0805A390JTT	2-1676859-4	26
TYC0805A391JFT	3-1676856-6	26
TYC0805A391JGT	3-1676857-6	26
TYC0805A391JHT	3-1676858-6	26
TYC0805A391JTT	3-1676859-6	26
TYC0805A392JFT	4-1676856-8	26
TYC0805A392JGT	4-1676857-8	26
TYC0805A399JFT	1-1676856-2	26
TYC0805A399JGT	1-1676857-2	26
TYC0805A399JHT	1-1676858-2	26
TYC0805A399JTT	1-1676859-2	26
TYC0805A470JFT	2-1676856-5	26
TYC0805A470JGT	2-1676857-5	26
TYC0805A470JHT	2-1676858-5	26
TYC0805A470JTT	2-1676859-5	26
TYC0805A471JFT	3-1676856-7	26
TYC0805A471JGT	3-1676857-7	26
TYC0805A471JHT	3-1676858-7	26
TYC0805A471JTT	3-1676859-7	26
TYC0805A472JFT	4-1676856-9	26
TYC0805A472JGT	4-1676857-9	26
TYC0805A478JFT	1676856-1	26
TYC0805A478JGT	1676857-1	26
TYC0805A478JHT	1676858-1	26
TYC0805A478JTT	1676859-1	26
TYC0805A479JFT	1-1676856-3	26
TYC0805A479JGT	1-1676857-3	26
TYC0805A479JHT	1-1676858-3	26
TYC0805A479JTT	1-1676859-3	26
TYC0805A479JFT	1-1676856-3	26
TYC0805A479JGT	1-1676857-3	26
TYC0805A479JHT	1-1676858-3	26
TYC0805A479JTT	1-1676859-3	26
TYC0805A560JFT	2-1676856-6	26
TYC0805A560JGT	2-1676857-6	26
TYC0805A560JHT	2-1676858-6	26
TYC0805A560JTT	2-1676859-6	26
TYC0805A561JFT	3-1676856-8	26
TYC0805A561JGT	3-1676857-8	26
TYC0805A561JHT	3-1676858-8	26
TYC0805A562JFT	5-1676856-0	26
TYC0805A562JGT	5-1676857-0	26
TYC0805A568JFT	1676856-2	26
TYC0805A568JGT	1676857-2	26
TYC0805A568JHT	1676858-2	26
TYC0805A568JTT	1676859-2	26
TYC0805A569JFT	1-1676856-4	26
TYC0805A569JGT	1-1676857-4	26
TYC0805A569JHT	1-1676858-4	26
TYC0805A569JTT	1-1676859-4	26
TYC0805A680JFT	2-1676856-7	26
TYC0805A680JGT	2-1676857-7	26
TYC0805A680JHT	2-1676858-7	26
TYC0805A680JTT	2-1676859-7	26
TYC0805A681JFT	3-1676856-9	26
TYC0805A681JGT	3-1676857-9	26
TYC0805A681JHT	3-1676858-9	26
TYC0805A682JFT	5-1676856-1	26
TYC0805A682JGT	5-1676857-1	26
TYC0805A688JFT	1676856-3	26
TYC0805A688JGT	1676857-3	26
TYC0805A688JHT	1676858-3	26
TYC0805A688JTT	1676859-3	26
TYC0805A689JFT	1-1676856-5	26
TYC0805A689JGT	1-1676857-5	26
TYC0805A689JHT	1-1676858-5	26
TYC0805A689JTT	1-1676859-5	26
TYC0805A820JFT	2-1676856-8	26
TYC0805A820JGT	2-1676857-8	26
TYC0805A820JHT	2-1676858-8	26
TYC0805A820JTT	2-1676859-8	26
TYC0805A821JFT	4-1676856-0	26
TYC0805A821JGT	4-1676857-0	26
TYC0805A821JHT	4-1676858-0	26
TYC0805A822JFT	5-1676856-2	26
TYC0805A822JGT	5-1676857-2	26
TYC0805A828JFT	1676856-4	26
TYC0805A828JGT	1676857-4	26
TYC0805A828JHT	1676858-4	26
TYC0805A828JTT	1676859-4	26

Brand Part No.	Tyco Part No.	Page No.
TYC0805A829JFT	1-1676856-6	26
TYC0805A829JGT	1-1676857-6	26
TYC0805A829JHT	1-1676858-6	26
TYC0805A829JTT	1-1676859-6	26
TYC0805B102KFT	1-1676875-3	26
TYC0805B102KGT	1-1676876-3	26
TYC0805B102KHT	1-1676877-3	26
TYC0805B102KJT	1-1676878-3	26
TYC0805B103KFT	2-1676875-5	26
TYC0805B103KGT	2-1676876-5	26
TYC0805B103KHT	2-1676877-5	26
TYC0805B104KFT	3-1676874-7	26
TYC0805B104KGT	3-1676875-7	26
TYC0805B104KHT	3-1676876-7	26
TYC0805B105KFT	4-1676873-9	26
TYC0805B105KGT	4-1676874-9	26
TYC0805B122KFT	1-1676875-4	26
TYC0805B122KGT	1-1676876-4	26
TYC0805B122KHT	1-1676877-4	26
TYC0805B122KJT	1-1676878-4	26
TYC0805B123KFT	2-1676875-6	26
TYC0805B123KGT	2-1676876-6	26
TYC0805B123KHT	2-1676877-6	26
TYC0805B124KFT	3-1676874-8	26
TYC0805B124KGT	3-1676875-8	26
TYC0805B124KHT	3-1676876-8	26
TYC0805B152KFT	1-1676875-2	26
TYC0805B152KGT	1-1676876-2	26
TYC0805B152KHT	1-1676877-2	26
TYC0805B153KFT	2-1676875-7	26
TYC0805B153KGT	2-1676876-7	26
TYC0805B153KHT	2-1676877-7	26
TYC0805B154KFT	3-1676874-9	26
TYC0805B154KGT	3-1676875-9	26
TYC0805B154KHT	3-1676876-9	26
TYC0805B181KFT	1676875-4	26
TYC0805B181KGT	1676876-4	26
TYC0805B181KHT	1676877-4	26
TYC0805B182KFT	1-1676875-6	26
TYC0805B182KGT	1-1676876-6	26
TYC0805B182KHT	1-1676877-6	26
TYC0805B183KFT	2-1676875-8	26
TYC0805B183KGT	2-1676876-8	26
TYC0805B183KHT	2-1676877-8	26
TYC0805B184KFT	4-1676874-0	26
TYC0805B221KFT	1676875-5	26
TYC0805B221KGT	1676876-5	26
TYC0805B221KHT	1676877-5	26
TYC0805B221KJT	1676878-5	26
TYC0805B222KFT	1-1676875-7	26
TYC0805B222KGT	1-1676876-7	26
TYC0805B222KHT	1-1676877-7	26
TYC0805B223KFT	2-1676875-9	26
TYC0805B223KGT	2-1676876-9	26
TYC0805B223KHT	2-1676877-9	26
TYC0805B224KFT	4-1676873-1	26
TYC0805B224KGT	4-1676874-1	26
TYC0805B271KFT	1676875-6	26
TYC0805B271KGT	1676876-6	26
TYC0805B271KHT	1676877-6	26
TYC0805B271KJT	1676878-6	26
TYC0805B272KFT	1-1676875-8	26
TYC0805B272KGT	1-1676876-8	26
TYC0805B272KHT	1-1676877-8	26
TYC0805B273KFT	3-1676875-0	26
TYC0805B273KGT	3-1676876-0	26
TYC0805B273KHT	3-1676877-0	26
TYC0805B274KFT	4-1676873-2	26
TYC0805B274KGT	4-1676874-2	26
TYC0805B331KFT	1676875-7	26
TYC0805B331KGT	1676876-7	26
TYC0805B331KHT	1676877-7	26
TYC0805B331KJT	1676878-7	26
TYC0805B332KFT	1-1676875-9	26
TYC0805B332KGT	1-1676876-9	26
TYC0805B332KHT	1-1676877-9	26

Brand Part No.	Tyco Part No.	Page No.
TYC0805B332KJT	1-1676878-9	26
TYC0805B333KFT	3-1676875-1	26
TYC0805B333KGT	3-1676876-1	26
TYC0805B334KDT	4-1676873-3	26
TYC0805B334KEP	4-1676874-3	26
TYC0805B391KFT	1676875-8	26
TYC0805B391KGT	1676876-8	26
TYC0805B391KHT	1676877-8	26
TYC0805B391KJT	1676878-8	26
TYC0805B392KFT	2-1676875-0	26
TYC0805B392KGT	2-1676876-0	26
TYC0805B392KHT	2-1676877-0	26
TYC0805B392KJT	2-1676878-0	26
TYC0805B393KFT	3-1676875-2	26
TYC0805B393KGT	3-1676876-2	26
TYC0805B394KDT	4-1676873-4	26
TYC0805B394KEP	4-1676874-4	26
TYC0805B471KFT	1676875-9	26
TYC0805B471KGT	1676876-9	26
TYC0805B471KHT	1676877-9	26
TYC0805B471KJT	1676878-9	26
TYC0805B472KFT	2-1676875-1	26
TYC0805B472KGT	2-1676876-1	26
TYC0805B472KHT	2-1676877-1	26
TYC0805B472KJT	2-1676878-1	26
TYC0805B473KFT	3-1676875-3	26
TYC0805B473KGT	3-1676876-3	26
TYC0805B474KDT	4-1676873-5	26
TYC0805B474KEP	4-1676874-5	26
TYC0805B561KFT	1-1676875-0	26
TYC0805B561KGT	1-1676876-0	26
TYC0805B561KHT	1-1676877-0	26
TYC0805B561KJT	1-1676878-0	26
TYC0805B562KFT	2-1676875-2	26
TYC0805B562KGT	2-1676876-2	26
TYC0805B562KHT	2-1676877-2	26
TYC0805B562KJT	2-1676878-2	26
TYC0805B563KFT	3-1676875-4	26
TYC0805B563KGT	3-1676876-4	26
TYC0805B564KDT	4-1676873-6	26
TYC0805B564KEP	4-1676874-6	26
TYC0805B681KFT	1-1676875-1	26
TYC0805B681KGT	1-1676876-1	26
TYC0805B681KHT	1-1676877-1	26
TYC0805B681KJT	1-1676878-1	26
TYC0805B682KFT	2-1676875-3	26
TYC0805B682KGT	2-1676876-3	26
TYC0805B682KHT	2-1676877-3	26
TYC0805B682KJT	2-1676878-3	26
TYC0805B683KFT	3-1676875-5	26
TYC0805B683KGT	3-1676876-5	26
TYC0805B684KDT	4-1676873-7	26
TYC0805B684KEP	4-1676874-7	26
TYC0805B821KFT	1-1676875-2	26
TYC0805B821KGT	1-1676876-2	26
TYC0805B821KHT	1-1676877-2	26
TYC0805B821KJT	1-1676878-2	26
TYC0805B822KFT	2-1676875-4	26
TYC0805B822KGT	2-1676876-4	26
TYC0805B822KHT	2-1676877-4	26
TYC0805B822KJT	2-1676878-4	26
TYC0805B824KDT	4-1676873-8	26
TYC0805B824KEP	4-1676874-8	26
TYC0805D104ZFT	1-1676896-3	26
TYC0805D104ZGT	1-1676897-3	26
TYC0805D105ZEP	2-1676895-5	26
TYC0805D124ZFT	1-1676896-4	26
TYC0805D124ZGT	1-1676897-4	26
TYC0805D125ZEP	2-1676895-6	26
TYC0805D154ZFT	1-1676896-5	26
TYC0805D154ZGT	1-1676897-5	26
TYC0805D155ZEP	2-1676895-7	26
TYC0805D184ZFT	1-1676896-6	26
TYC0805D184ZGT	1-1676897-6	26
TYC0805D185ZEP	2-1676895-8	26
TYC0805D224ZFT	1-1676895-7	26
TYC0805D224ZGT	1-1676896-7	26

Brand Part No.	Tyco Part No.	Page No.
TYC0805D225ZEP	2-1676895-9	26
TYC0805D274ZET	1-1676895-8	26
TYC0805D274ZFT	1-1676896-8	26
TYC0805D334ZET	1-1676895-2	26
TYC0805D334ZFP	1-1676896-9	26
TYC0805D394ZET	2-1676895-0	26
TYC0805D394ZFP	2-1676896-0	26
TYC0805D473ZFT	1676896-9	26
TYC0805D473ZGT	1676897-9	26
TYC0805D474ZET	2-1676895-4	26
TYC0805D474ZFP	2-1676896-1	26
TYC0805D563ZFT	1-1676896-0	26
TYC0805D563ZGT	1-1676897-0	26
TYC0805D564ZET	2-1676895-2	26
TYC0805D564ZFP	2-1676896-2	26
TYC0805D683ZFT	1-1676897-1	26
TYC0805D683ZGT	1-1676898-3	26
TYC0805D823ZFT	1-1676896-2	26
TYC0805D823ZGT	1-1676897-2	26
TYC0805D824ZET	2-1676895-4	26
TYC0805D824ZFP	2-1676896-4	26
TYC1206A100JHT	1-1676860-7	26
TYC1206A100JHT	1-1676861-7	26
TYC1206A100JHT	1-1676862-7	26
TYC1206A100JHT	1-1676863-7	26
TYC1206A101JHT	2-1676861-9	26
TYC1206A101JHT	2-1676862-9	26
TYC1206A101JHT	2-1676863-9	2

Brand Part No.	Tyco Part No.	Page No.
TYC1206A189JGT	1676860-8	26
TYC1206A189JHT	1676861-8	26
TYC1206A189JLT	1676862-8	26
TYC1206A189JLT	1676863-8	26
TYC1206A220JGT	2-1676860-1	26
TYC1206A220JHT	2-1676861-1	26
TYC1206A220JLT	2-1676862-1	26
TYC1206A220JLT	2-1676863-1	26
TYC1206A221JGT	3-1676860-3	26
TYC1206A221JHT	3-1676861-3	26
TYC1206A221JLT	3-1676862-3	26
TYC1206A221JLT	3-1676863-3	26
TYC1206A222JGT	4-1676860-5	26
TYC1206A222JHT	4-1676861-5	26
TYC1206A222JLT	4-1676862-5	26
TYC1206A229JGT	1676860-9	26
TYC1206A229JHT	1676861-9	26
TYC1206A229JLT	1676862-9	26
TYC1206A229JLT	1676863-9	26
TYC1206A270JGT	2-1676860-2	26
TYC1206A270JHT	2-1676861-2	26
TYC1206A270JLT	2-1676862-2	26
TYC1206A270JLT	2-1676863-2	26
TYC1206A271JGT	3-1676860-4	26
TYC1206A271JHT	3-1676861-4	26
TYC1206A271JLT	3-1676862-4	26
TYC1206A271JLT	3-1676863-4	26
TYC1206A272JGT	4-1676860-6	26
TYC1206A272JHT	4-1676861-6	26
TYC1206A279JGT	1-1676860-0	26
TYC1206A279JHT	1-1676861-0	26
TYC1206A279JLT	1-1676862-0	26
TYC1206A279JLT	1-1676863-0	26
TYC1206A330JGT	2-1676860-3	26
TYC1206A330JHT	2-1676861-3	26
TYC1206A330JLT	2-1676862-3	26
TYC1206A330JLT	2-1676863-3	26
TYC1206A331JGT	3-1676860-5	26
TYC1206A331JHT	3-1676861-5	26
TYC1206A331JLT	3-1676862-5	26
TYC1206A331JLT	3-1676863-5	26
TYC1206A332JGT	4-1676860-7	26
TYC1206A332JHT	4-1676861-7	26
TYC1206A339JGT	1-1676860-1	26
TYC1206A339JHT	1-1676861-1	26
TYC1206A339JLT	1-1676862-1	26
TYC1206A339JLT	1-1676863-1	26
TYC1206A390JGT	2-1676860-4	26
TYC1206A390JHT	2-1676861-4	26
TYC1206A390JLT	2-1676862-4	26
TYC1206A390JLT	2-1676863-4	26
TYC1206A391JGT	3-1676860-6	26
TYC1206A391JHT	3-1676861-6	26
TYC1206A391JLT	3-1676862-6	26
TYC1206A391JLT	3-1676863-6	26
TYC1206A392JGT	4-1676860-8	26
TYC1206A392JHT	4-1676861-8	26
TYC1206A399JGT	1-1676860-2	26
TYC1206A399JHT	1-1676861-2	26
TYC1206A399JLT	1-1676862-2	26
TYC1206A399JLT	1-1676863-2	26
TYC1206A470JGT	2-1676860-5	26
TYC1206A470JHT	2-1676861-5	26
TYC1206A470JLT	2-1676862-5	26
TYC1206A470JLT	2-1676863-5	26
TYC1206A471JGT	3-1676860-7	26
TYC1206A471JHT	3-1676861-7	26
TYC1206A471JLT	3-1676862-7	26
TYC1206A471JLT	3-1676863-7	26
TYC1206A472JGT	4-1676860-9	26
TYC1206A472JHT	4-1676861-9	26
TYC1206A479JGT	1-1676860-3	26
TYC1206A479JHT	1-1676861-3	26
TYC1206A479JLT	1-1676862-3	26
TYC1206A479JLT	1-1676863-3	26
TYC1206A560JGT	2-1676860-6	26
TYC1206A560JHT	2-1676861-6	26
TYC1206A560JLT	2-1676862-6	26
TYC1206A561JGT	3-1676860-8	26
TYC1206A561JHT	3-1676861-8	26
TYC1206A561JLT	3-1676862-8	26

Brand Part No.	Tyco Part No.	Page No.
TYC1206A561JLT	3-1676863-8	26
TYC1206A562JGT	5-1676860-0	26
TYC1206A569JGT	1-1676860-4	26
TYC1206A569JHT	1-1676861-4	26
TYC1206A569JLT	1-1676862-4	26
TYC1206A569JLT	1-1676863-4	26
TYC1206A680JGT	2-1676860-7	26
TYC1206A680JHT	2-1676861-7	26
TYC1206A680JLT	2-1676862-7	26
TYC1206A680JLT	2-1676863-7	26
TYC1206A681JGT	3-1676860-9	26
TYC1206A681JHT	3-1676861-9	26
TYC1206A681JLT	3-1676862-9	26
TYC1206A681JLT	3-1676863-9	26
TYC1206A682JGP	5-1676860-1	26
TYC1206A689JGT	1-1676860-5	26
TYC1206A689JHT	1-1676861-5	26
TYC1206A689JLT	1-1676862-5	26
TYC1206A689JLT	1-1676863-5	26
TYC1206A820JGT	2-1676860-8	26
TYC1206A820JHT	2-1676861-8	26
TYC1206A820JLT	2-1676862-8	26
TYC1206A820JLT	2-1676863-8	26
TYC1206A821JGT	4-1676860-2	26
TYC1206A821JHT	4-1676861-2	26
TYC1206A821JLT	4-1676862-2	26
TYC1206A821JLT	4-1676863-2	26
TYC1206A822JGP	5-1676860-2	26
TYC1206A829JGT	1-1676860-6	26
TYC1206A829JHT	1-1676861-6	26
TYC1206A829JLT	1-1676862-6	26
TYC1206A829JLT	1-1676863-6	26
TYC1206B102KGT	1-1676882-3	26
TYC1206B102KHT	1-1676883-3	26
TYC1206B102KJT	1-1676884-3	26
TYC1206B102KLP	1-1676885-3	26
TYC1206B103KGT	2-1676882-5	26
TYC1206B103KHT	2-1676883-5	26
TYC1206B103KJT	2-1676884-5	26
TYC1206B103KLP	2-1676885-5	26
TYC1206B104KGT	3-1676882-7	26
TYC1206B104KHP	3-1676883-7	26
TYC1206B105KDT	4-1676879-9	26
TYC1206B105KEP	4-1676880-9	26
TYC1206B122KGT	1-1676882-4	26
TYC1206B122KHT	1-1676883-4	26
TYC1206B122KJT	1-1676884-4	26
TYC1206B122KLP	1-1676885-4	26
TYC1206B123KGT	2-1676882-6	26
TYC1206B123KHT	2-1676883-6	26
TYC1206B123KJT	2-1676884-6	26
TYC1206B124KGT	3-1676882-8	26
TYC1206B125KDP	5-1676879-0	26
TYC1206B152KGT	1-1676882-5	26
TYC1206B152KHT	1-1676883-5	26
TYC1206B152KJP	1-1676884-5	26
TYC1206B152KLP	1-1676885-5	26
TYC1206B153KGT	2-1676882-7	26
TYC1206B153KHT	2-1676883-7	26
TYC1206B153KJT	2-1676884-7	26
TYC1206B154KFT	3-1676881-9	26
TYC1206B154KGP	3-1676882-9	26
TYC1206B155KDP	5-1676879-1	26
TYC1206B181KGT	1676882-4	26
TYC1206B181KHT	1676883-4	26
TYC1206B181KJT	1676884-4	26
TYC1206B181KLT	1676885-4	26
TYC1206B182KGT	1-1676882-6	26
TYC1206B182KHT	1-1676883-6	26
TYC1206B182KJT	1-1676884-6	26
TYC1206B182KLP	1-1676885-6	26
TYC1206B183KGT	2-1676882-8	26
TYC1206B183KHT	2-1676883-8	26
TYC1206B183KJP	2-1676884-8	26
TYC1206B184KFT	4-1676881-0	26
TYC1206B184KGP	4-1676882-0	26
TYC1206B185KDP	5-1676879-2	26
TYC1206B221KGT	1676882-5	26
TYC1206B221KHT	1676883-5	26
TYC1206B221KJT	1676884-5	26
TYC1206B221KLT	1676885-5	26

Brand Part No.	Tyco Part No.	Page No.
TYC1206B222KGT	1-1676882-7	26
TYC1206B222KHT	1-1676883-7	26
TYC1206B222KJT	1-1676884-7	26
TYC1206B222KLP	1-1676885-7	26
TYC1206B223KGT	2-1676882-9	26
TYC1206B223KHT	2-1676883-9	26
TYC1206B223KJP	2-1676884-9	26
TYC1206B224KFT	4-1676881-1	26
TYC1206B224KGP	4-1676882-1	26
TYC1206B225KDP	5-1676879-3	26
TYC1206B271KGT	1676882-6	26
TYC1206B271KHT	1676883-6	26
TYC1206B271KJT	1676884-6	26
TYC1206B271KLT	1676885-6	26
TYC1206B272KGT	1-1676882-8	26
TYC1206B272KHT	1-1676883-8	26
TYC1206B272KJT	1-1676884-8	26
TYC1206B272KLP	1-1676885-8	26
TYC1206B273KGT	3-1676883-0	26
TYC1206B273KHT	3-1676884-0	26
TYC1206B273KJP	3-1676885-0	26
TYC1206B274KFT	4-1676881-2	26
TYC1206B331KGT	1676882-7	26
TYC1206B331KHT	1676883-7	26
TYC1206B331KJT	1676884-7	26
TYC1206B331KLT	1676885-7	26
TYC1206B332KGT	1-1676882-9	26
TYC1206B332KHT	1-1676883-9	26
TYC1206B332KJT	1-1676884-9	26
TYC1206B332KLP	1-1676885-9	26
TYC1206B333KGT	3-1676882-1	26
TYC1206B333KHT	3-1676883-1	26
TYC1206B333KHT	3-1676884-1	26
TYC1206B334KFT	4-1676881-3	26
TYC1206B334KHT	4-1676882-3	26
TYC1206B334KHT	4-1676883-3	26
TYC1206B339KGT	1676883-8	26
TYC1206B339KHT	1676884-8	26
TYC1206B339KHT	1676885-8	26
TYC1206B339KHT	2-1676882-0	26
TYC1206B392KGT	2-1676883-0	26
TYC1206B392KHT	2-1676884-0	26
TYC1206B392KHT	2-1676885-0	26
TYC1206B393KGT	3-1676882-2	26
TYC1206B393KHT	3-1676883-2	26
TYC1206B394KET	4-1676880-4	26
TYC1206B394KFT	4-1676881-4	26
TYC1206B471KGT	1676882-9	26
TYC1206B471KHT	1676883-9	26
TYC1206B471KHT	1676884-9	26
TYC1206B471KLP	1-1676885-9	26
TYC1206B472KGT	2-1676882-1	26
TYC1206B472KHT	2-1676883-1	26
TYC1206B472KHT	2-1676884-1	26
TYC1206B472KLP	2-1676885-1	26
TYC1206B473KGT	3-1676882-3	26
TYC1206B473KHT	3-1676883-3	26
TYC1206B474KET	4-1676880-5	26
TYC1206B561KGT	1-1676882-0	26
TYC1206B561KHT	1-1676883-0	26
TYC1206B561KJT	1-1676884-0	26
TYC1206B561KLP	1-1676885-0	26
TYC1206B562KGT	2-1676882-2	26
TYC1206B562KHT	2-1676883-2	26
TYC1206B562KHT	2-1676884-2	26
TYC1206B562KLP	2-1676885-2	26
TYC1206B682KHT	2-1676882-2	26
TYC1206B682KHT	2-1676883-2	26
TYC1206B682KHT	2-1676884-2	26
TYC1206B682KHT	2-1676885-2	26
TYC1206B682KHT	2-1676886-2	26
TYC1206B681KGT	1-1676882-1	26
TYC1206B681KHT	1-1676883-1	26
TYC1206B681KJT	1-1676884-1	26
TYC1206B681KLP	1-1676885-1	26
TYC1206B682KGT	2-1676882-3	26
TYC1206B682KHT	2-1676883-3	26
TYC1206B682KHT	2-1676884-3	26
TYC1206B682KHT	2-1676885-3	26
TYC1206B684KEP	4-1676880-7	26
TYC1206B823KGT	3-1676882-5	26
TYC1206B823KHT	3-1676883-5	26
TYC1206B823KHT	3-1676884-5	26
TYC1206B823ZFT	1-1676900-1	26
TYC1206D103ZFT	1676900-1	26
TYC1206D103ZGT	1676901-1	26
TYC1206D104ZFT	1-1676900-3	26
TYC1206D104ZGT	1-1676901-3	26
TYC1206D105ZET	2-1676899-5	26
TYC1206D105ZFP	2-1676900-5	26
TYC1206D105ZGP	2-1676901-5	26
TYC1206D106ZDP	3-1676898-6	26
TYC1206D123ZFT	1676900-2	26
TYC1206D123ZFT	1676901-2	26
TYC1206D124ZFT	1-1676900-4	26
TYC1206D124ZGT	1-1676901-4	26
TYC1206D125ZET	2-1676899-6	26
TYC1206D125ZFP	2-1676900-6	26
TYC1206D126ZDP	3-1676898-7	26
TYC1206D154ZFT	1-1676900-5	26
TYC1206D154ZGT	1-1676901-5	26
TYC1206D155ZET	2-1676899-7	26
TYC1206D155ZFP	2-1676900-7	26
TYC1206D183ZFT	1676900-4	26
TYC1206D183ZGT	1676901-4	26
TYC1206D184ZFT	1-1676900-6	

Brand Part No.	Tyco Part No.	Page No.
TYEE0J107F55MTR	1879293-4	44
TYEE0J226D55MTR	1879293-1	44
TYEE0J227F80MTR	1879293-5	44
TYEE0J336E55MTR	1879293-2	44
TYEE0J476E55MTR	1879293-3	44
TYEE1A107F55MTR	1879293-9	44
TYEE1A226E55MTR	1879293-6	44
TYEE1A336E55MTR	1879293-7	44
TYEE1A476F55MTR	1879293-8	44
TYEE1C106D55MTR	1-1879293-0	44
TYEE1C107F55MTR	1-1879293-4	44
TYEE1C157F80MTR	1-1879293-5	44
TYEE1C226E55MTR	1-1879293-1	44
TYEE1C336F55MTR	1-1879293-2	44
TYEE1C476F55MTR	1-1879293-3	44
TYEE1E106E55MTR	1-1879293-6	44
TYEE1E107F80MTR	2-1879293-0	44
TYEE1E226F55MTR	1-1879293-7	44
TYEE1E336F55MTR	1-1879293-8	44
TYEE1E476F55MTR	1-1879293-9	44
TYEE1V106E55MTR	2-1879293-2	44
TYEE1V226F55MTR	2-1879293-3	44
TYEE1V336F55MTR	2-1879293-4	44
TYEE1V475D55MTR	2-1879293-1	44
TYEE1V476F80MTR	2-1879293-5	44
TYEH0J107F55MTR	1879291-4	40
TYEH0J108H10MTR	1879291-7	40
TYEH0J226D55MTR	1879291-1	40
TYEH0J336E55MTR	1879291-2	40
TYEH0J337G10MTR	1879291-5	40
TYEH0J476E55MTR	1879291-3	40
TYEH0J477G10MTR	1879291-6	40
TYEH1A107F55MTR	1-1879291-1	40
TYEH1A107G68MTR	1-1879291-2	40
TYEH1A108H10MTR	1-1879291-8	40
TYEH1A226E55MTR	1879291-8	40
TYEH1A227F80MTR	1-1879291-3	40
TYEH1A227G10MTR	1-1879291-4	40
TYEH1A336E55MTR	1879291-9	40
TYEH1A337G10MTR	1-1879291-5	40
TYEH1A476F55MTR	1-1879291-0	40
TYEH1A477G10MTR	1-1879291-6	40
TYEH1A477H10MTR	1-1879291-7	40
TYEH1C106D55MTR	1-1879291-9	40
TYEH1C107F55MTR	2-1879291-3	40
TYEH1C107H10MTR	2-1879291-5	40
TYEH1C107G10MTR	2-1879291-3	40
TYEH1C226E55MTR	2-1879291-0	40
TYEH1C227F80MTR	2-1879291-4	40
TYEH1C227H10MTR	2-1879291-5	40
TYEH1C336F55MTR	2-1879291-1	40
TYEH1C337G10MTR	2-1879291-6	40
TYEH1C337H10MTR	2-1879291-7	40
TYEH1C476F55MTR	2-1879291-8	40
TYEH1C477H10MTR	2-1879291-9	40
TYEH1E106E55MTR	1-1879291-9	40
TYEH1E107F55MTR	2-1879291-3	40
TYEH1E226E55MTR	2-1879291-0	40
TYEH1E227F80MTR	2-1879291-4	40
TYEH1E227H10MTR	2-1879291-5	40
TYEH1E336F55MTR	2-1879291-1	40
TYEH1E476F80MTR	2-1879291-6	40
TYEH1H104D60MTR	2-1879291-7	40
TYEH1H106F55MTR	2-1879291-2	40
TYEH1H107G10MTR	2-1879291-8	40
TYEH1H107H10MTR	2-1879291-9	40
TYEH1E106E55MTR	3-1879291-1	40
TYEH1E107F80MTR	3-1879291-6	40
TYEH1E107G10MTR	3-1879291-7	40
TYEH1E226F55MTR	3-1879291-2	40
TYEH1E227G10MTR	3-1879291-8	40
TYEH1E227H10MTR	3-1879291-9	40
TYEH1E336F55MTR	3-1879291-3	40
TYEH1E337H10MTR	4-1879291-0	40
TYEH1E475D55MTR	3-1879291-0	40
TYEH1E476F55MTR	3-1879291-4	40
TYEH1E476G68MTR	3-1879291-5	40
TYEH1E477H10MTR	4-1879291-1	40
TYEH1H104D55MTR	5-1879291-2	40
TYEH1H105D55MTR	5-1879291-6	40
TYEH1H106F55MTR	6-1879291-0	40
TYEH1H107G10MTR	6-1879291-6	40
TYEH1H107H10MTR	6-1879291-7	40
TYEH1H224D55MTR	5-1879291-3	40
TYEH1H225D55MTR	5-1879291-7	40
TYEH1H226G68MTR	6-1879291-1	40
TYEH1H227H10MTR	6-1879291-8	40
TYEH1H334D55MTR	5-1879291-4	40
TYEH1H335D55MTR	5-1879291-8	40
TYEH1H336F80MTR	6-1879291-2	40
TYEH1H336G10MTR	6-1879291-3	40
TYEH1H336H10MTR	6-1879291-5	40
TYEH1H474D55MTR	5-1879291-4	40
TYEH1H475E55MTR	5-1879291-9	40
TYEH1H476E55MTR	5-1879291-9	40

Brand Part No.	Tyco Part No.	Page No.
TYEH1H476F80MTR	6-1879291-4	40
TYEH1H476G10MTR	6-1879291-5	40
TYEH1J226G10MTR	6-1879291-9	40
TYEH1J336H10MTR	7-1879291-0	40
TYEH1J476G10MTR	7-1879291-1	40
TYEH1J476H10MTR	7-1879291-2	40
TYEH1V106E55MTR	4-1879291-3	40
TYEH1V107G10MTR	4-1879291-9	40
TYEH1V107H10MTR	4-1879291-8	40
TYEH1V226F55MTR	4-1879291-4	40
TYEH1V227H10MTR	5-1879291-0	40
TYEH1V336F60MTR	4-1879291-5	40
TYEH1V336G68MTR	4-1879291-6	40
TYEH1V337H10MTR	5-1879291-1	40
TYEH1V475D55MTR	4-1879291-2	40
TYEH1V476G10MTR	4-1879291-7	40
TYEH2A106G10MTR	7-1879291-3	40
TYEH2A226G10MTR	7-1879291-4	40
TYEH2A226H10MTR	7-1879291-5	40
TYEH2A336H10MTR	7-1879291-6	40
TYELOJ107F60MTR	1879292-4	46
TYELOJ108H10MTR	1879292-8	46
TYELOJ226D60MTR	1879292-1	46
TYELOJ227F80MTR	1879292-5	46
TYELOJ336E60MTR	1879292-2	46
TYELOJ337G10MTR	1879292-6	46
TYELOJ476E60MTR	1879292-3	46
TYELOJ477H10MTR	1879292-7	46
TYEL1A107F80MTR	1-1879292-2	46
TYEL1A226E60MTR	1879292-9	46
TYEL1A227G10MTR	1-1879292-3	46
TYEL1A336E60MTR	1-1879292-0	46
TYEL1A337H10MTR	1-1879292-4	46
TYEL1A476F60MTR	1-1879292-1	46
TYEL1A477H10MTR	1-1879292-5	46
TYEL1C106D60MTR	1-1879292-6	46
TYEL1C107F80MTR	2-1879292-0	46
TYEL1C226E60MTR	1-1879292-7	46
TYEL1C227H10MTR	2-1879292-1	46
TYEL1C336F60MTR	1-1879292-8	46
TYEL1C337H10MTR	2-1879292-2	46
TYEL1C476F60MTR	1-1879292-9	46
TYEL1C477H10MTR	2-1879292-3	46
TYEL1E106E60MTR	2-1879292-4	46
TYEL1E107G10MTR	2-1879292-8	46
TYEL1E226F60MTR	2-1879292-5	46
TYEL1E227H10MTR	2-1879292-9	46
TYEL1E336F60MTR	2-1879292-6	46
TYEL1E337H10MTR	3-1879292-0	46
TYEL1E476F80MTR	2-1879292-7	46
TYEL1H104D60MTR	3-1879292-8	46
TYEL1H105D60MTR	4-1879292-2	46
TYEL1H106F60MTR	4-1879292-6	46
TYEL1H107H10MTR	5-1879292-0	46
TYEL1H224D60MTR	3-1879292-9	46
TYEL1H225D60MTR	4-1879292-3	46
TYEL1H226F80MTR	4-1879292-7	46
TYEL1H334D60MTR	4-1879292-0	46
TYEL1H335D60MTR	4-1879292-4	46
TYEL1H336G10MTR	4-1879292-8	46
TYEL1H474D60MTR	4-1879292-1	46
TYEL1H475E60MTR	4-1879292-5	46
TYEL1H476G10MTR	4-1879292-9	46
TYEL1V106E60MTR	3-1879292-2	46
TYEL1V107H10MTR	3-1879292-6	46
TYEL1V226F60MTR	3-1879292-3	46
TYEL1V227H10MTR	3-1879292-7	46
TYEL1V336F80MTR	3-1879292-4	46
TYEL1V475D60MTR	3-1879292-1	46
TYEL1V476G10MTR	3-1879292-5	46
TYEV0J107E55MTR	1879290-5	36
TYEV0J107F55MTR	1879290-6	36
TYEV0J108G10MTR	1-1879290-1	36
TYEV0J108H10MTR	1-1879290-2	36
TYEV0J226D55MTR	1879290-1	36
TYEV0J227F55MTR	1879290-2	36
TYEV0J336D55MTR	1879290-7	36
TYEV0J337F80MTR	1879290-8	36
TYEV0J337G68MTR	1879290-9	36
TYEV0J476D55MTR	1879290-3	36
TYEV0J476E55MTR	1879290-4	36

Brand Part No.	Tyco Part No.	Page No.
TYEV0J477G10MTR	1-1879290-0	36
TYEV1A107E55MTR	1-1879290-7	36
TYEV1A107F55MTR	1-1879290-8	36
TYEV1A108H10MTR	2-1879290-4	36
TYEV1A226D55MTR	1-1879290-3	36
TYEV1A227F80MTR	1-1879290-9	36
TYEV1A227G68MTR	2-1879290-0	36
TYEV1A336D55MTR	1-1879290-4	36
TYEV1A336E55MTR	1-1879290-5	36
TYEV1A337G10MTR	2-1879290-1	36
TYEV1A476F55MTR	1-1879290-6	36
TYEV1A477G10MTR	2-1879290-2	36
TYEV1A477H10MTR	2-1879290-3	36
TYEV1C106D55MTR	2-1879290-5	36
TYEV1C107F55MTR	3-1879290-1	36
TYEV1C107G68MTR	3-1879290-2	36
TYEV1C107H10MTR	3-1879290-3	36
TYEV1C226D55MTR	2-1879290-6	36
TYEV1C226E55MTR	2-1879290-7	36
TYEV1C227F80MTR	3-1879290-7	36
TYEV1C227G10MTR	3-1879290-4	36
TYEV1C336E55MTR	2-1879290-8	36
TYEV1C337G10MTR	3-1879290-5	36
TYEV1C337H10MTR	3-1879290-6	36
TYEV1C476E55MTR	2-1879290-9	36
TYEV1C476F55MTR	3-1879290-0	36
TYEV1C477G10MTR	3-1879290-6	36
TYEV1C477H10MTR	3-1879290-7	36
TYEV1E106D55MTR	3-1879290-9	36
TYEV1E106E55MTR	4-1879290-0	36
TYEV1E107F80MTR	4-1879290-6	36
TYEV1E107G68MTR	4-1879290-7	36
TYEV1E226E55MTR	4-1879290-1	36
TYEV1E226F55MTR	4-1879290-2	36
TYEV1E227G10MTR	4-1879290-8	36
TYEV1E227H10MTR	4-1879290-3	36
TYEV1E336E55MTR	4-1879290-3	36
TYEV1E336F55MTR	4-1879290-4	36
TYEV1E337G10MTR	4-1879290-9	36
TYEV1E337H10MTR	5-1879290-0	36
TYEV1E475D55MTR	3-1879290-8	36
TYEV1E476F55MTR	4-1879290-5	36
TYEV1E477H10MTR	5-1879290-1	36
TYEV1H104D55MTR	6-1879290-6	36
TYEV1H105D55MTR	7-1879290-0	36
TYEV1H106E55MTR	7-1879290-5	36
TYEV1H106F55MTR	7-1879290-6	36
TYEV1H107G10MTR	8-1879290-3	36
TYEV1H107H10MTR	8-1879290-4	36
TYEV1H225D55MTR	7-1879290-1	36
TYEV1H226F55MTR	7-1879290-7	36
TYEV1H106F55MTR	7-1879290-8	36
TYEV1H227H10MTR	8-1879290-5	36
TYEV1H334D55MTR	6-1879290-8	36
TYEV1H335D55MTR	7-1879290-2	36
TYEV1H336F80MTR	7-1879290-9	36
TYEV1H336G68MTR	8-1879290-0	36
TYEV1H474D55MTR	6-1879290-9	36
TYEV1H475D55MTR	7-1879290-3	36
TYEV1H475E55MTR	7-1879290-4	36
TYEV1H476F80MTR	8-1879290-1	36
TYEV1H476G10MTR	8-1879290-2	36
TYEV1V106D55MTR	5-1879290-3	36
TYEV1V106E55MTR	5-1879290-4	36
TYEV1V107F80MTR	6-1879290-1	36
TYEV1V107G10MTR	6-1879290-2	36
TYEV1V226E55MTR	5-1879290-5	36
TYEV1V226F55MTR	5-1879290-6	36
TYEV1V227G10MTR	6-1879290-3	36
TYEV1V227H10MTR	6-1879290-4	36
TYEV1V336F55MTR	5-1879290-7	36
TYEV1V336G68MTR	5-1879290-8	36
TYEV1V337H10MTR	6-1879290-5	36
TYEV1V475D55MTR	5-1879290-2	36
TYEV1V476F55MTR	5-1879290-9	36
TYEV1V476G68MTR	6-1879290-0	36
TYOH0E108H82MTR	1879294-4	49
TYOH0E128H10MTR	1879294-5	49
TYOH0E158H13MTR	1879294-6	49
TYOH0E227F62MTR	1879294-1	49
TYOH0E567G2MTR	1879294-2	49
TYOH0E687G12MTR	1-1879294-3	49
TYOH0G477H82MTR	1-1879294-0	49
TYOH0G567G12MTR	1-1879294-1	49
TYOH0G687H82MTR	1-1879294-2	49
TYOH0J477H10MTR	1-1879294-3	49
TYOH0J107F62MTR	1-1879294-6	49
TYOH0J127F72MTR	1-1879294-7	49
TYOH0J157F12MTR	1-1879294-8	49
TYOH0J157G72MTR	1-1879294-9	49
TYOH0J227F72MTR	2-1879294-0	49
TYOH0J227G72MTR	2-1879294-1	49
TYOH0J3		

Brand Part No.	Tyco Part No.	Page No.
TYRE1A159G40ML	6-1879303-7	67
TYRE1A187B11ML	4-1879303-0	67
TYRE1A226A11ML	3-1879303-4	67
TYRE1A227B11ML	4-1879303-1	67
TYRE1A227B15ML	4-1879303-2	67
TYRE1A228D30ML	5-1879303-2	67
TYRE1A228E20ML	5-1879303-3	67
TYRE1A278E25ML	5-1879303-4	67
TYRE1A336A11ML	3-1879303-5	67
TYRE1A337C11ML	4-1879303-3	67
TYRE1A338E25ML	5-1879303-5	67
TYRE1A338E30ML	5-1879303-6	67
TYRE1A398E35ML	5-1879303-7	67
TYRE1A398F20ML	5-1879303-8	67
TYRE1A476A11ML	3-1879303-6	67
TYRE1A477C11ML	4-1879303-4	67
TYRE1A478F25ML	5-1879303-9	67
TYRE1A568F25ML	6-1879303-0	67
TYRE1A568G20ML	6-1879303-1	67
TYRE1A687C15ML	4-1879303-5	67
TYRE1A687D12ML	4-1879303-6	67
TYRE1A688F31ML	6-1879303-2	67
TYRE1A688G25ML	6-1879303-3	67
TYRE1A826A11ML	3-1879303-4	67
TYRE1A828F35ML	6-1879303-4	67
TYRE1A828G31ML	6-1879303-5	67
TYRE1C106A11ML	6-1879303-8	67
TYRE1C107B11ML	7-1879303-3	67
TYRE1C108D20ML	8-1879303-4	67
TYRE1C109G40ML	1879304-2	67
TYRE1C127B11ML	7-1879303-4	67
TYRE1C128D25ML	8-1879303-5	67
TYRE1C157B11ML	7-1879303-5	67
TYRE1C158D30ML	8-1879303-6	67
TYRE1C158E20ML	8-1879303-7	67
TYRE1C187B15ML	7-1879303-6	67
TYRE1C226A11ML	6-1879303-9	67
TYRE1C227C11ML	7-1879303-7	67
TYRE1C228E25ML	8-1879303-8	67
TYRE1C228E30ML	8-1879303-9	67
TYRE1C278F20ML	9-1879303-0	67
TYRE1C336A11ML	7-1879303-0	67
TYRE1C337C11ML	7-1879303-8	67
TYRE1C338E35ML	9-1879303-1	67
TYRE1C338F25ML	9-1879303-2	67
TYRE1C398F25ML	9-1879303-3	67
TYRE1C398G20ML	9-1879303-4	67
TYRE1C476A11ML	7-1879303-1	67
TYRE1C477C15ML	7-1879303-9	67
TYRE1C477D12ML	8-1879303-0	67
TYRE1C478F31ML	9-1879303-5	67
TYRE1C478G25ML	9-1879303-6	67
TYRE1C568A11ML	7-1879303-2	67
TYRE1C568F35ML	9-1879303-7	67
TYRE1C568G31ML	9-1879303-8	67
TYRE1C687C20ML	8-1879303-1	67
TYRE1C687D16ML	8-1879303-2	67
TYRE1C688G35ML	9-1879303-9	67
TYRE1C827D20ML	8-1879303-3	67
TYRE1C828G35ML	1879304-1	67
TYRE1E106A11ML	1879304-4	67
TYRE1E107B11ML	1-1879304-0	67
TYRE1E108D30ML	2-1879304-1	67
TYRE1E108E20ML	2-1879304-2	67
TYRE1E127B15ML	1-1879304-1	67
TYRE1E157C11ML	1-1879304-2	67
TYRE1E158E25ML	2-1879304-3	67
TYRE1E158F25ML	2-1879304-4	67
TYRE1E188E30ML	2-1879304-5	67
TYRE1E188F20ML	2-1879304-6	67
TYRE1E226A11ML	1879304-5	67
TYRE1E227C11ML	1-1879304-3	67
TYRE1E228E35ML	2-1879304-7	67
TYRE1E228F25ML	2-1879304-8	67
TYRE1E228G20ML	2-1879304-9	67
TYRE1E278F25ML	3-1879304-0	67
TYRE1E336A11ML	1879304-6	67
TYRE1E337C15ML	1-1879304-7	67
TYRE1E337D12ML	1-1879304-5	67
TYRE1E338F31ML	3-1879304-1	67
TYRE1E338G25ML	3-1879304-2	67

Brand Part No.	Tyco Part No.	Page No.
TYRE1E396A11ML	1879304-7	67
TYRE1E398F35ML	3-1879304-3	67
TYRE1E398G31ML	3-1879304-4	67
TYRE1E475A11ML	1879304-3	67
TYRE1E476A11ML	1879304-8	67
TYRE1E477C20ML	1-1879304-6	67
TYRE1E477D16ML	1-1879304-7	67
TYRE1E478G35ML	3-1879304-5	67
TYRE1E567D20ML	1-1879304-8	67
TYRE1E687D20ML	1-1879304-9	67
TYRE1E688G40ML	3-1879304-6	67
TYRE1E826B11ML	1879304-9	67
TYRE1E827D25ML	2-1879304-0	67
TYRE1H106A11ML	7-1879304-0	67
TYRE1H107C11ML	7-1879304-7	67
TYRE1H108F25ML	9-1879304-5	67
TYRE1H127C15ML	7-1879304-8	67
TYRE1H127D12ML	7-1879304-9	67
TYRE1H128F31ML	9-1879304-6	67
TYRE1H128G25ML	9-1879304-7	67
TYRE1H157D12ML	8-1879304-0	67
TYRE1H158F31ML	9-1879304-8	67
TYRE1H158F35ML	9-1879304-9	67
TYRE1H186A11ML	7-1879304-1	67
TYRE1H187C20ML	8-1879304-1	67
TYRE1H187D16ML	8-1879304-2	67
TYRE1H188G31ML	1879305-1	67
TYRE1H226A11ML	7-1879304-2	67
TYRE1H227D16ML	8-1879304-3	67
TYRE1H227D20ML	8-1879304-4	67
TYRE1H228G35ML	1879305-2	67
TYRE1H27D25ML	8-1879304-5	67
TYRE1H336B11ML	7-1879304-3	67
TYRE1H337D20ML	8-1879304-6	67
TYRE1H337D30ML	8-1879304-7	67
TYRE1H397E20ML	8-1879304-8	67
TYRE1H475A11ML	6-1879304-9	67
TYRE1H476B11ML	7-1879304-4	67
TYRE1H477E20ML	8-1879304-9	67
TYRE1H566B15ML	7-1879304-5	67
TYRE1H567E25ML	9-1879304-0	67
TYRE1H687E25ML	9-1879304-1	67
TYRE1H687F20ML	9-1879304-2	67
TYRE1H826C11ML	7-1879304-6	67
TYRE1H827E35ML	9-1879304-3	67
TYRE1H827G20ML	9-1879304-4	67
TYRE1J106A11ML	1879305-5	67
TYRE1J107C15ML	1-1879305-3	67
TYRE1J107D12ML	1-1879305-4	67
TYRE1J108F31ML	3-1879305-3	67
TYRE1J108F35ML	3-1879305-4	67
TYRE1J126A11ML	1879305-6	67
TYRE1J127D16ML	1-1879305-5	67
TYRE1J128G31ML	3-1879305-5	67
TYRE1J156B11ML	1879305-7	67
TYRE1J157D16ML	1-1879305-6	67
TYRE1J158G35ML	3-1879305-6	67
TYRE1J187D20ML	1-1879305-7	67
TYRE1J187E16ML	1-1879305-8	67
TYRE1J226B11ML	1879305-8	67
TYRE1J227D20ML	1-1879305-9	67
TYRE1J227D25ML	2-1879305-0	67
TYRE1J228G40ML	3-1879305-7	67
TYRE1J277F16ML	2-1879305-1	67
TYRE1J336B11ML	1879305-9	67
TYRE1J337E20ML	2-1879305-2	67
TYRE1J396B15ML	1-1879305-0	67
TYRE1J397E25ML	2-1879305-3	67
TYRE1J397G16ML	2-1879305-4	67
TYRE1J475A11ML	1879305-3	67
TYRE1J476C11ML	1-1879305-1	67
TYRE1J477E25ML	2-1879305-5	67
TYRE1J477E30ML	2-1879305-6	67
TYRE1J477F20ML	2-1879305-7	67
TYRE1J567F25ML	2-1879305-8	67
TYRE1J685A11ML	1879305-4	67
TYRE1J686C11ML	1-1879305-2	67
TYRE1J687E35ML	2-1879305-9	67
TYRE1J687G20ML	3-1879305-0	67
TYRE1J827F31ML	3-1879305-1	67
TYRE1J827G25ML	3-1879305-2	67

Brand Part No.	Tyco Part No.	Page No.
TYRE1V106A11ML	3-1879304-8	67
TYRE1V107C11ML	4-1879304-5	67
TYRE1V108E25ML	5-1879304-6	67
TYRE1V128E30ML	5-1879304-7	67
TYRE1V128F20ML	5-1879304-8	67
TYRE1V157C11ML	4-1879304-6	67
TYRE1V158E35ML	5-1879304-9	67
TYRE1V158F25ML	6-1879304-0	67
TYRE1V188F25ML	6-1879304-1	67
TYRE1V188G20ML	6-1879304-2	67
TYRE1V226A11ML	3-1879304-9	67
TYRE1V227C15ML	4-1879304-7	67
TYRE1V227D12ML	4-1879304-8	67
TYRE1V228F31ML	6-1879304-3	67
TYRE1V228G25ML	6-1879304-4	67
TYRE1V276A11ML	4-1879304-0	67
TYRE1V278F35ML	6-1879304-5	67
TYRE1V278G31ML	6-1879304-6	67
TYRE1V336A11ML	4-1879304-1	67
TYRE1V337C20ML	4-1879304-9	67
TYRE1V337D16ML	5-1879304-0	67
TYRE1V338G35ML	6-1879304-7	67
TYRE1V397D20ML	5-1879304-1	67
TYRE1V475A11ML	3-1879304-7	67
TYRE1V476B11ML	4-1879304-2	67
TYRE1V477D20ML	5-1879304-2	67
TYRE1V478G40ML	6-1879304-8	67
TYRE1V566B11ML	4-1879304-3	67
TYRE1V567D25ML	5-1879304-3	67
TYRE1V687D30ML	5-1879304-4	67
TYRE1V687E20ML	5-1879304-5	67
TYRE1V826B15ML	4-1879304-4	67
TYRE2A105A11ML	3-1879305-9	67
TYRE2A106B11ML	4-1879305-4	67
TYRE2A107E20ML	5-1879305-4	67
TYRE2A156C11ML	4-1879305-5	67
TYRE2A157E25ML	5-1879305-5	67
TYRE2A186B15ML	4-1879305-6	67
TYRE2A187E30ML	5-1879305-6	67
TYRE2A187F20ML	5-1879305-7	67
TYRE2A225A11ML	4-1879305-0	67
TYRE2A226C11ML	4-1879305-7	67
TYRE2A227F25ML	5-1879305-8	67
TYRE2A227D20ML	5-1879305-9	67
TYRE2A335A11ML	4-1879305-1	67
TYRE2A336C15ML	4-1879305-8	67
TYRE2A336D12ML	4-1879305-9	67
TYRE2A337F25ML	6-1879305-0	67
TYRE2A397G25ML	6-1879305-1	67
TYRE2A474A11ML	3-1879305-8	67
TYRE2A475A11ML	4-1879305-2	67
TYRE2A476C20ML	5-1879305-0	67
TYRE2A476D16ML	5-1879305-1	67
TYRE2A477F31ML	6-1879305-2	67
TYRE2A567G31ML	6-1879305-3	67
TYRE2A567G35ML	6-1879305-4	67
TYRE2A685A11ML	4-1879305-3	67
TYRE2A686D20ML	5-1879305-2	67
TYRE2A826D25ML	5-1879305-3	67
TYRE2A827G40ML	6-1879305-5	67
TYRH0J107A11ML	1879301-3	60
TYRH0J108C11ML	1879301-7	60
TYRH0J108E25ML	1-1879301-1	60
TYRH0J109F25ML	1-1879301-2	60
TYRH0J227A11ML	1879301-4	60
TYRH0J228D20ML	1879301-8	60
TYRH0J229G40ML	1-1879301-3	60
TYRH0J336A11ML	1879301-1	60
TYRH0J337B11ML	1879301-5	60
TYRH0J338D20ML	1879301-9	60
TYRH0J476A11ML	1879301-2	60
TYRH0J477B11ML	1879301-6	60
TYRH0J477E20ML	1-1879301-0	60
TYRH1A107A11ML	1-1879301-7	60
TYRH1A108D12ML	2-1879301-1	60
TYRH1A108F25ML	2-1879301-5	60
TYRH1A109F35ML	2-1879301-6	60
TYRH1A226A11ML	1-1879301-4	60
TYRH1A227B11ML	1-1879301-8	60
TYRH1A228D20ML	2-1879301-2	60
TYRH1A336A11ML	1879302-1	60
TYRH1A338E20ML	2-1879301-3	60
TYRH1A476A11ML	1-1879301-6	60
TYRH1A477C11ML	2-1879301-7	60
TYRH1A477E25ML	2-1879301-4	60
TYRH1C106A11ML	2-1879301-7	60
TYRH1C107A11ML	3-1879301-1	60
TYRH1C108D16ML	3-1879301-5	60
TYRH1C108F31ML	3-1879301-9	60
TYRH1C109G35ML	4-1879301-0	60
TYRH1C226A11ML	2-1879301-8	60
TYRH1C227B11ML	3-1879301-2	60
TYRH1C228E20ML	3-1879301-6	60
TYRH1C336A11ML	2-1879301-9	60
TYRH1C337C11ML	3-1879301-3	60
TYRH1C338E25ML	3-1879301-7	60
TYRH1C476A11ML	3-1879301-0	60
TYRH1C477C11ML	3-1879301-4	60
TYRH1C477E20ML	3-1879301-8	60
TYRH1E106A11ML	4-1879301-2	60
TYRH1E107B11ML	4-1879301-6	60
TYRH1E108D20ML	5-1879301-1	60
TYRH1E108G35ML	5-1879301-5	60
TYRH1E226A11ML	4-1879301-3	60
TYRH1E227C11ML	4-1879301-7	60
TYRH1E228E25ML	5-1879301-2	60
TYRH1E336A11ML	4-1879301-4	60
TYRH1E338F25ML	5-1879301-3	60
TYRH1E475A11ML	4-1879301-1	60
TYRH1E476A11ML	4-1879301-5	60
TYRH1E477D12ML	5-1879301-0	60
TYRH1H105A11ML	7-1	

Brand Part No.	Tyco Part No.	Page No.
TYRH2A105A11ML	1879302-7	60
TYRH2A106B11ML	1-1879302-1	60
TYRH2A107D20ML	1-1879302-5	60
TYRH2A108G40ML	1-1879302-9	60
TYRH2A224A11ML	1879302-4	60
TYRH2A225A11ML	1879302-8	60
TYRH2A226B11ML	1-1879302-2	60
TYRH2A227E20ML	1-1879302-6	60
TYRH2A334A11ML	1879302-5	60
TYRH2A335A11ML	1879302-9	60
TYRH2A336C11ML	1-1879302-3	60
TYRH2A337F25ML	1-1879302-7	60
TYRH2A447A11ML	1879302-6	60
TYRH2A475A11ML	1-1879302-0	60
TYRH2A476D12ML	1-1879302-4	60
TYRH2A477F31ML	1-1879302-8	60
TYRH2C105B11ML	2-1879302-1	60
TYRH2C106D12ML	2-1879302-5	60
TYRH2C107E25ML	2-1879302-9	60
TYRH2C107F25ML	3-1879302-0	60
TYRH2C225B11ML	2-1879302-2	60
TYRH2C226D20ML	2-1879302-6	60
TYRH2C227F31ML	3-1879302-1	60
TYRH2C335B11ML	2-1879302-3	60
TYRH2C336D20ML	2-1879302-7	60
TYRH2C337G35ML	3-1879302-2	60
TYRH2C474B11ML	2-1879302-0	60
TYRH2C475B11ML	2-1879302-4	60
TYRH2C476E20ML	2-1879302-8	60
TYRH2D105B11ML	3-1879302-4	60
TYRH2D106D12ML	3-1879302-8	60
TYRH2D107F25ML	4-1879302-2	60
TYRH2D225B11ML	3-1879302-5	60
TYRH2D226D20ML	3-1879302-9	60
TYRH2D227G35ML	4-1879302-3	60
TYRH2D335B11ML	3-1879302-6	60
TYRH2D336E20ML	4-1879302-0	60
TYRH2D474B11ML	3-1879302-3	60
TYRH2D475C11ML	3-1879302-7	60
TYRH2D476E25ML	4-1879302-1	60
TYRH2E106D16ML	4-1879302-1	60
TYRH2E107F35ML	5-1879302-1	60
TYRH2E225B11ML	4-1879302-4	60
TYRH2E226E20ML	4-1879302-8	60
TYRH2E227H40ML	5-1879302-2	60
TYRH2E335C11ML	4-1879302-5	60
TYRH2E336E20ML	4-1879302-9	60
TYRH2E475C11ML	4-1879302-6	60
TYRH2E476E25ML	5-1879302-0	60
TYRH2G105C11ML	6-1879302-2	60
TYRH2G106E20ML	6-1879302-6	60
TYRH2G107H40ML	7-1879302-1	60
TYRH2G225D12ML	6-1879302-3	60
TYRH2G226E25ML	6-1879302-7	60
TYRH2G227F25ML	6-1879302-1	60
TYRH2G335D16ML	6-1879302-4	60
TYRH2G336F31ML	6-1879302-9	60
TYRH2G475D20ML	6-1879302-5	60
TYRH2G476F35ML	7-1879302-0	60
TYRH2V105B11ML	5-1879302-3	60
TYRH2V106D20ML	5-1879302-7	60
TYRH2V107G40ML	6-1879302-1	60
TYRH2V225C11ML	5-1879302-4	60
TYRH2V226E20ML	5-1879302-8	60
TYRH2V476F31ML	6-1879302-0	60
TYRH2V105C11ML	7-1879302-2	60
TYRH2W106E20ML	7-1879302-6	60
TYRH2W107H45ML	8-1879302-0	60
TYRH2W225D12ML	7-1879302-3	60
TYRH2W226F25ML	7-1879302-7	60
TYRH2W335D16ML	7-1879302-4	60
TYRH2W336F31ML	7-1879302-8	60
TYRH2W475D20ML	7-1879302-5	60
TYRH2W476G40ML	7-1879302-9	60
TYRL2D107F25ML	1879306-6	75
TYRL2D107G20ML	1879306-7	75
TYRL2D157F31ML	1879306-8	75
TYRL2D226D20ML	1879306-1	75

Brand Part No.	Tyco Part No.	Page No.
TYRL2D227G35ML	1879306-9	75
TYRL2D336E20ML	1879306-2	75
TYRL2D337G40ML	1-1879306-0	75
TYRL2D476E20ML	1879306-3	75
TYRL2D686E25ML	1879306-4	75
TYRL2D686F20ML	1879306-5	75
TYRL2E107F31ML	1-1879306-6	75
TYRL2E107G25ML	1-1879306-7	75
TYRL2E157G31ML	1-1879306-8	75
TYRL2E226E20ML	1-1879306-1	75
TYRL2E227G40ML	1-1879306-9	75
TYRL2E336E25ML	1-1879306-2	75
TYRL2E476E25ML	1-1879306-3	75
TYRL2E476F20ML	1-1879306-4	75
TYRL2E686F25ML	1-1879306-5	75
TYRL2G106D20ML	2-1879306-7	75
TYRL2G107G35ML	3-1879306-5	75
TYRL2G156E20ML	2-1879306-8	75
TYRL2G226E25ML	2-1879306-1	75
TYRL2G226F20ML	3-1879306-0	75
TYRL2G336F25ML	3-1879306-1	75
TYRL2G476F31ML	3-1879306-2	75
TYRL2G476G25ML	3-1879306-3	75
TYRL2G686G31ML	3-1879306-4	75
TYRL2V107G31ML	2-1879306-6	75
TYRL2V226E20ML	2-1879306-0	75
TYRL2V336F20ML	2-1879306-1	75
TYRL2V476F25ML	2-1879306-2	75
TYRL2V476G20ML	2-1879306-3	75
TYRL2V686F31ML	2-1879306-4	75
TYRL2V686G25ML	2-1879306-5	75
TYRL2W106E20ML	3-1879306-7	75
TYRL2W156E25ML	3-1879306-8	75
TYRL2W226F25ML	3-1879306-9	75
TYRL2W336F31ML	4-1879306-0	75
TYRL2W336G25ML	4-1879306-1	75
TYRL2W475D20ML	3-1879306-6	75
TYRL2W476G31ML	4-1879306-2	75
TYRL2W686G35ML	4-1879306-3	75
TYRVOJ107A11ML	1879299-3	53
TYRVOJ108C11ML	1879299-7	53
TYRVOJ109F25ML	1-1879299-2	53
TYRVOJ227A11ML	1879299-4	53
TYRVOJ228D20ML	1879299-8	53
TYRVOJ229G40ML	1-1879299-3	53
TYRVOJ229H40ML	1-1879299-4	53
TYRVOJ336A11ML	1879299-1	53
TYRVOJ337B11ML	1879299-5	53
TYRVOJ338D20ML	1879299-9	53
TYRVOJ476A11ML	1879299-2	53
TYRVOJ477B11ML	1879299-6	53
TYRVOJ478E20ML	1-1879299-0	53
TYRVOJ688E25ML	1-1879299-1	53
TYRVA107A11ML	1-1879299-8	53
TYRVA108D12ML	2-1879299-2	53
TYRVA109F35ML	2-1879299-7	53
TYRVA1A226A11ML	1-1879299-5	53
TYRVA1A227B11ML	1-1879299-9	53
TYRVA1A228D20ML	2-1879299-3	53
TYRVA1A229H40ML	2-1879299-8	53
TYRVA1A336A11ML	1-1879299-6	53
TYRVA1A337B11ML	2-1879299-0	53
TYRVA1A338E20ML	2-1879299-4	53
TYRVA1A476A11ML	1-1879299-7	53
TYRVA1A477B11ML	2-1879299-1	53
TYRVA1A478E25ML	2-1879299-5	53
TYRVA1A688F25ML	2-1879299-6	53
TYRVA1C106A11ML	2-1879299-9	53
TYRVA1C107A11ML	3-1879299-3	53
TYRVA1C108D16ML	3-1879299-7	53
TYRVA1C109G35ML	4-1879299-2	53
TYRVA1C226A11ML	3-1879299-0	53
TYRVA1C227B11ML	3-1879299-4	53
TYRVA1C228E20ML	3-1879299-8	53
TYRVA1C229H40ML	4-1879299-3	53
TYRVA1C336A11ML	3-1879299-1	53
TYRVA1C337C11ML	3-1879299-5	53
TYRVA1C338E25ML	3-1879299-9	53
TYRVA1C476A11ML	3-1879299-2	53
TYRVA1C477C11ML	3-1879299-6	53
TYRVA1C478F25ML	4-1879299-0	53

Brand Part No.	Tyco Part No.	Page No.
TYRV1C688F31ML	4-1879299-1	53
TYRV1E106A11ML	4-1879299-5	53
TYRV1E107B11ML	4-1879299-9	53
TYRV1E108D20ML	5-1879299-4	53
TYRV1E109H40ML	5-1879299-9	53
TYRV1E226A11ML	4-1879299-6	53
TYRV1E227C11ML	5-1879299-0	53
TYRV1E228E25ML	5-1879299-5	53
TYRV1E336A11ML	4-1879299-7	53
TYRV1E337C11ML	5-1879299-1	53
TYRV1E337D12ML	5-1879299-2	53
TYRV1E338F25ML	5-1879299-6	53
TYRV1E475A11ML	4-1879299-4	53
TYRV1E476A11ML	4-1879299-8	53
TYRV1E477D12ML	5-1879299-3	53
TYRV1E478F31ML	5-1879299-7	53
TYRV1E688G35ML	5-1879299-8	53
TYRV1H104A11ML	7-1879299-4	53
TYRV1H105A11ML	7-1879299-8	53
TYRV1H106A11ML	8-1879299-2	53
TYRV1H107C11ML	8-1879299-6	53
TYRV1H108E25ML	9-1879299-0	53
TYRV1H225A11ML	7-1879299-5	53
TYRV1H226A11ML	7-1879299-9	53
TYRV1H334A11ML	8-1879299-3	53
TYRV1H227D12ML	8-1879299-7	53
TYRV1H228F35ML	9-1879299-1	53
TYRV1H334A11ML	7-1879299-6	53
TYRV1H335A11ML	8-1879299-0	53
TYRV1H336A11ML	8-1879299-4	53
TYRV1H337D16ML	8-1879299-8	53
TYRV1H338G35ML	9-1879299-2	53
TYRV1H338H40ML	9-1879299-3	53
TYRV1H474A11ML	7-1879299-7	53
TYRV1H475A11ML	8-1879299-1	53
TYRV1H476B11ML	8-1879299-5	53
TYRV1H477D20ML	8-1879299-9	53
TYRV1H478H40ML	9-1879299-4	53
TYRV1H478J40ML	9-1879299-5	53
TYRV1J106A11ML	9-1879299-6	53
TYRV1J107D12ML	1879300-1	53
TYRV1J108F25ML	1879300-5	53
TYRV1J226B11ML	9-1879299-7	53
TYRV1J227D16ML	1879300-2	53
TYRV1J228G40ML	1879300-6	53
TYRV1J336B11ML	9-1879299-8	53
TYRV1J337D20ML	1879300-3	53
TYRV1J338H40ML	1879300-7	53
TYRV1J476B11ML	9-1879299-9	53
TYRV1J477E20ML	1879300-4	53
TYRV1J478J40ML	1879300-8	53
TYRV1V106A11ML	6-1879299-1	53
TYRV1V107B11ML	6-1879299-5	53
TYRV1V108E20ML	7-1879299-0	53
TYRV1V226A11ML	6-1879299-2	53
TYRV1V227C11ML	6-1879299-6	53
TYRV1V227D12ML	6-1879299-7	53
TYRV1V228F25ML	7-1879299-1	53
TYRV1V336A11ML	6-1879299-3	53
TYRV1V337D12ML	6-1879299-8	53
TYRV1V338F35ML	7-1879299-2	53
TYRV1V475A11ML	6-1879299-0	53
TYRV1V476A11ML	6-1879299-4	53
TYRV1V477D16ML	6-1879299-9	53
TYRV1V478G35ML	7-1879299-3	53
TYRV2A104A11ML	1879300-9	53
TYRV2A105A11ML	1-1879300-3	53
TYRV2A106B11ML	1-1879300-7	53
TYRV2A107D20ML	2-1879300-1	53
TYRV2A108G40ML	2-1879300-5	53
TYRV2A226A11ML	1-1879300-0	53
TYRV2A226B11ML	1-1879300-4	53
TYRV2A227E20ML	2-1879300-2	53
TYRV2A334A11ML	1-1879300-1	53
TYRV2A335A11ML	1-1879300-5	53
TYRV2A336C11ML	1-1879300-9	53
TYRV2A337F25ML	2-1879300-3	53
TYRV2A474A11ML	1-1879300-2	53
TYRV2A475A11ML	1-1879300-6	53
TYRV2A476D12ML	2-1879300-0	53

Brand Part No.	Tyco Part No.	Page No.
TYRV2A477F31ML	2-1879300-4	53
TYRV2C105B11ML	2-1879300-7	53
TYRV2C106D12ML	3-1879300-1	53
TYRV2C107E25ML	3-1879300-5	53
TYRV2C225B11ML	2-1879300-8	53
TYRV2C226D20ML	3-1879300-2	53
TYRV2C227F31ML	3-1879300-6	53
TYRV2C335B11ML	2-1879300-9	53
TYRV2C336D20ML	3-1879300-3	53
TYRV2C337G35ML	3-1879300-7	53
TYRV2C474B11ML	2-1879300-6	53
TYRV2C475B11ML	3-1879300-0	53
TYRV2C476E20ML	3-1879300-4	53
TYRV2D105B11ML	3-1879300-9	53
TYRV2D106D12ML	4-1879300-3	53
TYRV2D107E25ML	4-1879300-7	53
TYRV2D225B11ML	4-1879300-0	53
TYRV2D226D20ML	4-1879300-4	53
TYRV2D227F31ML	4-1879300-8	53
TYRV2D335B11ML	4-1879300-1	53
TYRV2D336E20ML	4-1879300-5	53
TYRV2D337G35ML	3-1879300-8	53
TYRV2D475C11ML	4-1879300-2	53
TYRV2D476B11ML	4-1879300-6	53
TYRV2E106D16ML	5-1879300-2	53
TYRV2E107F35ML	5-1879300-6	53
TYRV2E225B11ML	4-1879300-9	53
TYRV2E226E20ML	5-1879300-3	53
TYRV2E227H40ML	5-1879300-7	53
TYRV2E335C11ML	5-1879300-0	53
TYRV2E336E20ML	5-1879300-4	53
TYRV2E475C11ML	5-1879300-1	53
TYRV2E4		

Brand Part No.	Tyco Part No.	Page No.
TYSH1E129L25ML	2-1879311-8	103
TYSH1E159J45ML	2-1879311-9	103
TYSH1E159K35ML	3-1879311-0	103
TYSH1E159L30ML	3-1879311-1	103
TYSH1E189J50ML	3-1879311-2	103
TYSH1E189K40ML	3-1879311-3	103
TYSH1E229K45ML	3-1879311-4	103
TYSH1E229L35ML	3-1879311-5	103
TYSH1E478H25ML	1-1879311-6	103
TYSH1E568H25ML	1-1879311-7	103
TYSH1E688H30ML	1-1879311-8	103
TYSH1E688J25ML	1-1879311-9	103
TYSH1E828H35ML	2-1879311-0	103
TYSH1E828J30ML	2-1879311-1	103
TYSH1E828K25ML	2-1879311-2	103
TYSH1H109K50ML	7-1879311-5	103
TYSH1H109L40ML	7-1879311-6	103
TYSH1H129L45ML	7-1879311-7	103
TYSH1H188H25ML	5-1879311-5	103
TYSH1H228H25ML	5-1879311-6	103
TYSH1H278H30ML	5-1879311-7	103
TYSH1H278J25ML	5-1879311-8	103
TYSH1H338H35ML	5-1879311-9	103
TYSH1H338J35ML	6-1879311-0	103
TYSH1H398H40ML	6-1879311-1	103
TYSH1H398J35ML	6-1879311-2	103
TYSH1H398K25ML	6-1879311-3	103
TYSH1H478H45ML	6-1879311-4	103
TYSH1H478K30ML	6-1879311-5	103
TYSH1H478L25ML	6-1879311-6	103
TYSH1H568H50ML	6-1879311-7	103
TYSH1H568J40ML	6-1879311-8	103
TYSH1H568K35ML	6-1879311-9	103
TYSH1H688J50ML	7-1879311-0	103
TYSH1H688K40ML	7-1879311-1	103
TYSH1H688L30ML	7-1879311-2	103
TYSH1H828K45ML	7-1879311-3	103
TYSH1H828L35ML	7-1879311-4	103
TYSH1J109L50ML	1879312-1	103
TYSH1J128H25ML	7-1879311-8	103
TYSH1J188H30ML	7-1879311-9	103
TYSH1J188J25ML	8-1879311-0	103
TYSH1J228H35ML	8-1879311-1	103
TYSH1J228J30ML	8-1879311-2	103
TYSH1J278H40ML	8-1879311-3	103
TYSH1J278J35ML	8-1879311-4	103
TYSH1J278K25ML	8-1879311-5	103
TYSH1J338H50ML	8-1879311-6	103
TYSH1J338J40ML	8-1879311-7	103
TYSH1J338K30ML	8-1879311-8	103
TYSH1J338L25ML	8-1879311-9	103
TYSH1J398J45ML	9-1879311-0	103
TYSH1J398K35ML	9-1879311-1	103
TYSH1J478J50ML	9-1879311-2	103
TYSH1J478K40ML	9-1879311-3	103
TYSH1J478L30ML	9-1879311-4	103
TYSH1J568K45ML	9-1879311-5	103
TYSH1J568L35ML	9-1879311-6	103
TYSH1J688K50ML	9-1879311-7	103
TYSH1J688L40ML	9-1879311-8	103
TYSH1J828L45ML	9-1879311-9	103
TYSH1V109J45ML	4-1879311-6	103
TYSH1V109K35ML	4-1879311-7	103
TYSH1V129J50ML	4-1879311-8	103
TYSH1V129K40ML	4-1879311-9	103
TYSH1V129L30ML	5-1879311-0	103
TYSH1V159K45ML	5-1879311-1	103
TYSH1V159L35ML	5-1879311-2	103
TYSH1V189L40ML	5-1879311-3	103
TYSH1V229L50ML	5-1879311-4	103
TYSH1V478J25ML	3-1879311-6	103
TYSH1V568H35ML	3-1879311-7	103
TYSH1V568J30ML	3-1879311-8	103
TYSH1V568K25ML	3-1879311-9	103
TYSH1V688H40ML	4-1879311-0	103
TYSH1V688J35ML	4-1879311-1	103
TYSH1V828H50ML	4-1879311-2	103
TYSH1V828J40ML	4-1879311-3	103
TYSH1V828K30ML	4-1879311-4	103
TYSH1V828L25ML	4-1879311-5	103
TYSH2A128H40ML	1879312-2	103

Brand Part No.	Tyco Part No.	Page No.
TYSH2A128J35ML	1879312-3	103
TYSH2A128K25ML	1879312-4	103
TYSH2A158H45ML	1879312-5	103
TYSH2A158J40ML	1879312-6	103
TYSH2A158K30ML	1879312-7	103
TYSH2A158L25ML	1879312-8	103
TYSH2A188J45ML	1879312-9	103
TYSH2A188K35ML	1-1879312-0	103
TYSH2A228J50ML	1-1879312-1	103
TYSH2A228K40ML	1-1879312-2	103
TYSH2A228L30ML	1-1879312-3	103
TYSH2A278K45ML	1-1879312-4	103
TYSH2A278L35ML	1-1879312-5	103
TYSH2A282L30ML	1-1879312-6	103
TYSH2A282K45ML	1-1879312-7	103
TYSH2A282J45ML	1-1879312-8	103
TYSH2A338K50ML	1-1879312-9	103
TYSH2A338L40ML	1-1879312-0	103
TYSH2A398L45ML	1-1879312-8	103
TYSH2A478L50ML	1-1879312-9	103
TYSH2A568L50ML	2-1879312-0	103
TYSH2C108J45ML	3-1879312-9	103
TYSH2C108K35ML	4-1879312-0	103
TYSH2C108L30ML	4-1879312-1	103
TYSH2C128J50ML	4-1879312-2	103
TYSH2C128K40ML	4-1879312-3	103
TYSH2C128L35ML	4-1879312-4	103
TYSH2C158K45ML	4-1879312-5	103
TYSH2C158K50ML	4-1879312-7	103
TYSH2C158L40ML	4-1879312-6	103
TYSH2C188L50ML	4-1879312-8	103
TYSH2C277H25ML	2-1879312-1	103
TYSH2C337H30ML	2-1879312-2	103
TYSH2C397H30ML	2-1879312-3	103
TYSH2C397J25ML	2-1879312-4	103
TYSH2C477H35ML	2-1879312-5	103
TYSH2C477J30ML	2-1879312-7	103
TYSH2C567H40ML	2-1879312-8	103
TYSH2C567J30ML	2-1879312-9	103
TYSH2C567K25ML	3-1879312-0	103
TYSH2C687H45ML	3-1879312-1	103
TYSH2C687J35ML	3-1879312-2	103
TYSH2C687K25ML	3-1879312-3	103
TYSH2C687K30ML	3-1879312-4	103
TYSH2C827H50ML	3-1879312-5	103
TYSH2C827J40ML	3-1879312-6	103
TYSH2C827K30ML	3-1879312-7	103
TYSH2C827L25ML	3-1879312-8	103
TYSH2D108K45ML	7-1879312-0	103
TYSH2D108L35ML	7-1879312-1	103
TYSH2D128L40ML	7-1879312-3	103
TYSH2D158L50ML	7-1879312-4	103
TYSH2D188L50ML	7-1879312-5	103
TYSH2D227H25ML	4-1879312-9	103
TYSH2D277H25ML	5-1879312-0	103
TYSH2D337H30ML	5-1879312-2	103
TYSH2D337J25ML	5-1879312-3	103
TYSH2D397H35ML	5-1879312-4	103
TYSH2D397K25ML	5-1879312-5	103
TYSH2D477H40ML	5-1879312-6	103
TYSH2D477J30ML	5-1879312-7	103
TYSH2D477K35ML	5-1879312-8	103
TYSH2D477L25ML	5-1879312-9	103
TYSH2D567H45ML	6-1879312-0	103
TYSH2D567J35ML	6-1879312-1	103
TYSH2D567K30ML	6-1879312-2	103
TYSH2D687H50ML	6-1879312-3	103
TYSH2D687J40ML	6-1879312-4	103
TYSH2D687K35ML	6-1879312-5	103
TYSH2D687L25ML	6-1879312-6	103
TYSH2D827J50ML	6-1879312-7	103
TYSH2D827K40ML	6-1879312-8	103
TYSH2D827L35ML	6-1879312-9	103
TYSH2E108L45ML	1879313-5	103
TYSH2E128L45ML	1879313-6	103
TYSH2E187H30ML	7-1879312-6	103
TYSH2E187J25ML	7-1879312-7	103
TYSH2E227H35ML	7-1879312-8	103
TYSH2E227J30ML	7-1879312-9	103
TYSH2E277H35ML	8-1879312-0	103
TYSH2E337H40ML	8-1879312-1	103

Brand Part No.	Tyco Part No.	Page No.
TYSH2E337J30ML	8-1879312-2	103
TYSH2E337J35ML	8-1879312-3	103
TYSH2E397H45ML	8-1879312-4	103
TYSH2E397H50ML	8-1879312-5	103
TYSH2E397J35ML	8-1879312-6	103
TYSH2E397J40ML	8-1879312-7	103
TYSH2E477H50ML	8-1879312-8	103
TYSH2E477J40ML	8-1879312-9	103
TYSH2E477J45ML	9-1879312-0	103
TYSH2E477K30ML	9-1879312-1	103
TYSH2E477K35ML	9-1879312-2	103
TYSH2E477L30ML	9-1879312-3	103
TYSH2E477L45ML	9-1879312-4	103
TYSH2E567K35ML	9-1879312-5	103
TYSH2E567K40ML	9-1879312-6	103
TYSH2E567L30ML	9-1879312-7	103
TYSH2E687J50ML	9-1879312-8	103
TYSH2E687K40ML	9-1879312-9	103
TYSH2E687L35ML	1879313-1	103
TYSH2E827K45ML	1879313-2	103
TYSH2E827K50ML	1879313-3	103
TYSH2E827L40ML	1879313-4	103
TYSH2G107H35ML	2-1879313-9	103
TYSH2G107J30ML	3-1879313-0	103
TYSH2G127H35ML	3-1879313-1	103
TYSH2G127H40ML	3-1879313-2	103
TYSH2G127J30ML	3-1879313-3	103
TYSH2G127J35ML	3-1879313-4	103
TYSH2G127K25ML	3-1879313-5	103
TYSH2G157H40ML	3-1879313-6	103
TYSH2G157H50ML	3-1879313-7	103
TYSH2G157J35ML	3-1879313-8	103
TYSH2G157J40ML	3-1879313-9	103
TYSH2G157K30ML	4-1879313-0	103
TYSH2G187H50ML	4-1879313-1	103
TYSH2G187J40ML	4-1879313-2	103
TYSH2G187J45ML	4-1879313-3	103
TYSH2G187K30ML	4-1879313-4	103
TYSH2G187K35ML	4-1879313-5	103
TYSH2G187L25ML	4-1879313-6	103
TYSH2G227J50ML	4-1879313-7	103
TYSH2G227K35ML	4-1879313-8	103
TYSH2G227K40ML	4-1879313-9	103
TYSH2G227L30ML	5-1879313-0	103
TYSH2G277J50ML	5-1879313-1	103
TYSH2G277K40ML	5-1879313-2	103
TYSH2G277K45ML	5-1879313-3	103
TYSH2G277L35ML	5-1879313-4	103
TYSH2G337K45ML	5-1879313-5	103
TYSH2G337L40ML	5-1879313-6	103
TYSH2G397K50ML	5-1879313-7	103
TYSH2G397L45ML	5-1879313-8	103
TYSH2G826J25ML	5-1879313-9	103
TYSH2G826H30ML	2-1879313-6	103
TYSH2G826H30ML	2-1879313-7	103
TYSH2G826H30ML	2-1879313-8	103
TYSH2V107H30ML	1879313-9	103
TYSH2V107J25ML	1-1879313-0	103
TYSH2V127H35ML	1-1879313-1	103
TYSH2V157H40ML	1-1879313-2	103
TYSH2V157J30ML	1-1879313-3	103
TYSH2V157K25ML	1-1879313-4	103
TYSH2V187J35ML	1-1879313-5	103
TYSH2V187K30ML	1-1879313-6	103
TYSH2V227J40ML	1-1879313-7	103
TYSH2V227K30ML	1-1879313-8	103
TYSH2V227L25ML	1-1879313-9	103
TYSH2V277K35ML	2-1879313-0	103
TYSH2V277L30ML	2-1879313-1	103
TYSH2V337K45ML	2-1879313-2	103
TYSH2V397L40ML	2-1879313-3	103
TYSH2V477L45ML	2-1879313-4	103
TYSH2V567L50ML	2-1879313-5	103
TYSH2V686H25ML	1879313-7	103
TYSH2V826H25ML	1879313-8	103
TYSH2W107H40ML	6-1879313-4	103
TYSH2W107J30ML	6-1879313-5	103
TYSH2W107K25ML	6-1879313-6	103
TYSH2W127H45ML	6-1879313-7	103
TYSH2W127J35ML	6-1879313-8	103
TYSH2W157H50ML	6-1879313-9	103

Brand Part No.	Tyco Part No.	Page No.
TYSH2W157J40ML	7-1879313-0	103
TYSH2W157K30ML	7-1879313-1	103
TYSH2W157L25ML	7-1879313-2	103
TYSH2W187J45ML	7-1879313-3	103
TYSH2W187K35ML	7-1879313-4	103
TYSH2W227J50ML	7-1879313-5	103
TYSH2W227K40ML	7-1879313-6	103
TYSH2W227L30ML	7-1879313-7	103
TYSH2W277K45ML	7-1879313-8	103
TYSH2W277L35ML	7-1879313-9	103
TYSH2W337K50ML	8-1879313-0	103
TYSH2W337L45ML	8-1879313-1	103
TYSH2W397L50ML	8-1879313-2	103
TYSH2W477L50ML	8-1879313-3	103
TYSH2W566H25ML	6-1879313-0	103
TYSH2W686H30ML	6-1879313-1	103
TYSH2W686J25ML	6-1879313-2	103
TYSH2W826H35ML	6-1879313-3	103
TYSV1C109H30ML	1879307-2	92
TYSV1C109J30ML	1879307-3	92
TYSV1C129H25ML	1879307-5	92
TYSV1C129J25ML	1879307-6	92

Brand Part No.	Tyco Part No.	Page No.
TYSV1J338H35ML	8-1879307-2	92
TYSV1J338J30ML	8-1879307-3	92
TYSV1J338K25ML	8-1879307-4	92
TYSV1J398H45ML	8-1879307-5	92
TYSV1J398J35ML	8-1879307-6	92
TYSV1J398K30ML	8-1879307-7	92
TYSV1J478H50ML	8-1879307-8	92
TYSV1J478J40ML	8-1879307-9	92
TYSV1J478K30ML	9-1879307-0	92
TYSV1J478L25ML	9-1879307-1	92
TYSV1J568J45ML	9-1879307-2	92
TYSV1J568K35ML	9-1879307-3	92
TYSV1J688J50ML	9-1879307-4	92
TYSV1J688K40ML	9-1879307-5	92
TYSV1J688L35ML	9-1879307-6	92
TYSV1J828K45ML	9-1879307-7	92
TYSV1J828L35ML	9-1879307-8	92
TYSV1V109H50ML	4-1879307-2	92
TYSV1V109J40ML	4-1879307-3	92
TYSV1V109K30ML	4-1879307-4	92
TYSV1V109L25ML	4-1879307-5	92
TYSV1V129J45ML	4-1879307-6	92
TYSV1V129K35ML	4-1879307-7	92
TYSV1V129L30ML	4-1879307-8	92
TYSV1V159K40ML	4-1879307-9	92
TYSV1V159L35ML	5-1879307-0	92
TYSV1V189K45ML	5-1879307-1	92
TYSV1V189L40ML	5-1879307-2	92
TYSV1V229L45ML	5-1879307-3	92
TYSV1V478H30ML	3-1879307-3	92
TYSV1V478J25ML	3-1879307-4	92
TYSV1V568H35ML	3-1879307-5	92
TYSV1V688H40ML	3-1879307-6	92
TYSV1V688J30ML	3-1879307-7	92
TYSV1V688K25ML	3-1879307-8	92
TYSV1V828H45ML	3-1879307-9	92
TYSV1V828J35ML	4-1879307-0	92
TYSV1V828K30ML	4-1879307-1	92
TYSV2A128H30ML	1879308-3	92
TYSV2A128J25ML	1879308-4	92
TYSV2A158H35ML	1879308-5	92
TYSV2A158J30ML	1879308-6	92
TYSV2A158K25ML	1879308-7	92
TYSV2A188H40ML	1879308-8	92
TYSV2A188J35ML	1879308-9	92
TYSV2A188K25ML	1-1879308-0	92
TYSV2A228H45ML	1-1879308-1	92
TYSV2A228J40ML	1-1879308-2	92
TYSV2A228K30ML	1-1879308-3	92
TYSV2A228L25ML	1-1879308-4	92
TYSV2A278J45ML	1-1879308-5	92
TYSV2A278K35ML	1-1879308-6	92
TYSV2A278L30ML	1-1879308-7	92
TYSV2A338J50ML	1-1879308-8	92
TYSV2A338K40ML	1-1879308-9	92
TYSV2A338L35ML	2-1879308-0	92
TYSV2A398K45ML	2-1879308-1	92
TYSV2A398L35ML	2-1879308-2	92
TYSV2A478K50ML	2-1879308-3	92
TYSV2A478L40ML	2-1879308-4	92
TYSV2A568L45ML	2-1879308-5	92
TYSV2A688L50ML	2-1879308-6	92
TYSV2C108H50ML	4-1879308-6	92
TYSV2C108J40ML	4-1879308-7	92
TYSV2C108K35ML	4-1879308-8	92
TYSV2C128J45ML	5-1879308-2	92
TYSV2C128K35ML	5-1879308-3	92
TYSV2C128L30ML	5-1879308-4	92
TYSV2C158K40ML	5-1879308-5	92
TYSV2C158L35ML	5-1879308-6	92
TYSV2C188K45ML	6-1879308-0	92
TYSV2C188L50ML	6-1879308-1	92
TYSV2C228L45ML	6-1879308-2	92
TYSV2C277H25ML	2-1879308-7	92
TYSV2C337H25ML	2-1879308-8	92

Brand Part No.	Tyco Part No.	Page No.
TYSV2C397H30ML	2-1879308-9	92
TYSV2C477H30ML	3-1879308-0	92
TYSV2C477J25ML	3-1879308-1	92
TYSV2C567H30ML	3-1879308-2	92
TYSV2C567H35ML	3-1879308-3	92
TYSV2C567J25ML	3-1879308-4	92
TYSV2C567J30ML	3-1879308-5	92
TYSV2C687H35ML	3-1879308-6	92
TYSV2C687H40ML	3-1879308-7	92
TYSV2C687J30ML	3-1879308-8	92
TYSV2C687K25ML	3-1879308-9	92
TYSV2C827H40ML	4-1879308-0	92
TYSV2C827H45ML	4-1879308-1	92
TYSV2C827J30ML	4-1879308-2	92
TYSV2C827J35ML	4-1879308-3	92
TYSV2C827K25ML	4-1879308-4	92
TYSV2C827K30ML	4-1879308-5	92
TYSV2D108J45ML	8-1879308-5	92
TYSV2D108K35ML	8-1879308-6	92
TYSV2D108L40ML	8-1879308-7	92
TYSV2D108K40ML	8-1879308-8	92
TYSV2D108L30ML	8-1879308-9	92
TYSV2D128K40ML	9-1879308-0	92
TYSV2D128K45ML	9-1879308-1	92
TYSV2D128L35ML	9-1879308-2	92
TYSV2D157H25ML	6-1879308-3	92
TYSV2D158K50ML	9-1879308-3	92
TYSV2D158L40ML	9-1879308-4	92
TYSV2D188L45ML	9-1879308-5	92
TYSV2D227H25ML	6-1879308-4	92
TYSV2D228L50ML	9-1879308-6	92
TYSV2D277H25ML	6-1879308-5	92
TYSV2D337H30ML	6-1879308-6	92
TYSV2D337J25ML	6-1879308-7	92
TYSV2D397H30ML	6-1879308-8	92
TYSV2D397J25ML	6-1879308-9	92
TYSV2D477H35ML	7-1879308-0	92
TYSV2D477J30ML	7-1879308-1	92
TYSV2D477K25ML	7-1879308-2	92
TYSV2D567H40ML	7-1879308-3	92
TYSV2D567J30ML	7-1879308-4	92
TYSV2D567K25ML	7-1879308-5	92
TYSV2D687H45ML	7-1879308-6	92
TYSV2D687J35ML	7-1879308-7	92
TYSV2D687K30ML	7-1879308-8	92
TYSV2D827H50ML	7-1879308-9	92
TYSV2D827J40ML	8-1879308-0	92
TYSV2D827J45ML	8-1879308-1	92
TYSV2D827K30ML	8-1879308-2	92
TYSV2D827K35ML	8-1879308-3	92
TYSV2D827L30ML	8-1879308-4	92
TYSV2E108K50ML	3-1879309-1	92
TYSV2E108L40ML	3-1879309-2	92
TYSV2E128L45ML	3-1879309-3	92
TYSV2E157H25ML	9-1879309-7	92
TYSV2E187H25ML	9-1879309-8	92
TYSV2E227H25ML	9-1879309-9	92
TYSV2E227J25ML	1879309-1	92
TYSV2E277H30ML	1879309-2	92
TYSV2E277J25ML	1879309-3	92
TYSV2E337H30ML	1879309-4	92
TYSV2E337H35ML	1879309-5	92
TYSV2E337J25ML	1879309-6	92
TYSV2E337J30ML	1879309-7	92
TYSV2E397H35ML	1879309-8	92
TYSV2E397H40ML	1879309-9	92
TYSV2E397J30ML	1-1879309-0	92
TYSV2E397J35ML	1-1879309-1	92
TYSV2E397K25ML	1-1879309-2	92
TYSV2E477H40ML	1-1879309-3	92
TYSV2E477H45ML	1-1879309-4	92
TYSV2E477J35ML	1-1879309-5	92
TYSV2E477K30ML	1-1879309-6	92
TYSV2E567H50ML	1-1879309-7	92
TYSV2E567J40ML	1-1879309-8	92
TYSV2E567J45ML	1-1879309-9	92
TYSV2E567K30ML	2-1879309-0	92
TYSV2E567K35ML	2-1879309-1	92
TYSV2E567L25ML	2-1879309-2	92
TYSV2E687J45ML	2-1879309-3	92
TYSV2E687J50ML	2-1879309-4	92

Brand Part No.	Tyco Part No.	Page No.
TYSV2E687K35ML	2-1879309-5	92
TYSV2E687K40ML	2-1879309-6	92
TYSV2E687L30ML	2-1879309-7	92
TYSV2E827K40ML	2-1879309-8	92
TYSV2E827K45ML	2-1879309-9	92
TYSV2E827L35ML	3-1879309-0	92
TYSV2G107H30ML	8-1879309-1	92
TYSV2G107J25ML	8-1879309-2	92
TYSV2G127H30ML	8-1879309-3	92
TYSV2G127H35ML	8-1879309-4	92
TYSV2G127J25ML	8-1879309-5	92
TYSV2G157H35ML	8-1879309-6	92
TYSV2G157H40ML	8-1879309-7	92
TYSV2G157J30ML	8-1879309-8	92
TYSV2G157K25ML	8-1879309-9	92
TYSV2G187H40ML	9-1879309-0	92
TYSV2G187H45ML	9-1879309-1	92
TYSV2G187J35ML	9-1879309-2	92
TYSV2G187K30ML	9-1879309-3	92
TYSV2G227H45ML	9-1879309-4	92
TYSV2G227H50ML	9-1879309-5	92
TYSV2G227J35ML	9-1879309-6	92
TYSV2G227J40ML	9-1879309-7	92
TYSV2G227K30ML	9-1879309-8	92
TYSV2G277L30ML	9-1879309-9	92
TYSV2G277J45ML	1879310-1	92
TYSV2G277K35ML	1879310-2	92
TYSV2G277L30ML	1879310-3	92
TYSV2G337J50ML	1879310-4	92
TYSV2G337K40ML	1879310-5	92
TYSV2G337L30ML	1879310-6	92
TYSV2G337L35ML	1879310-7	92
TYSV2G397K40ML	1879310-8	92
TYSV2G397K45ML	1879310-9	92
TYSV2G397L35ML	1-1879310-0	92
TYSV2G397L40ML	1-1879310-1	92
TYSV2G477K50ML	1-1879310-2	92
TYSV2G477L40ML	1-1879310-3	92
TYSV2G477L45ML	1-1879310-4	92
TYSV2G567L45ML	1-1879310-5	92
TYSV2G567L50ML	1-1879310-6	92
TYSV2G686H25ML	7-1879309-9	92
TYSV2G687L50ML	1-1879310-7	92
TYSV2G826H25ML	8-1879309-0	92
TYSV2H107H40ML	5-1879310-7	92
TYSV2H107J35ML	5-1879310-8	92
TYSV2H127H45ML	5-1879310-9	92
TYSV2H127J35ML	6-1879310-0	92
TYSV2H127K30ML	6-1879310-1	92
TYSV2H157J40ML	6-1879310-2	92
TYSV2H157K35ML	6-1879310-3	92
TYSV2H157L30ML	6-1879310-4	92
TYSV2H187J50ML	6-1879310-5	92
TYSV2H187K40ML	6-1879310-6	92
TYSV2H187L30ML	6-1879310-7	92
TYSV2H227K45ML	6-1879310-8	92
TYSV2H227L35ML	6-1879310-9	92
TYSV2H277L40ML	7-1879310-0	92
TYSV2H337L45ML	7-1879310-1	92
TYSV2H566H25ML	5-1879310-3	92
TYSV2H686H30ML	5-1879310-4	92
TYSV2H826H35ML	5-1879310-5	92
TYSV2H826J30ML	5-1879310-6	92
TYSV2V107H25ML	3-1879309-5	92
TYSV2V127H25ML	3-1879309-6	92
TYSV2V127H30ML	3-1879309-7	92
TYSV2V127J25ML	3-1879309-8	92
TYSV2V157H30ML	3-1879309-9	92
TYSV2V157H35ML	4-1879309-0	92
TYSV2V157J25ML	4-1879309-1	92
TYSV2V157J30ML	4-1879309-2	92
TYSV2V157K25ML	4-1879309-3	92
TYSV2V187H40ML	4-1879309-4	92
TYSV2V187J30ML	4-1879309-5	92
TYSV2V187J35ML	4-1879309-6	92
TYSV2V187K25ML	4-1879309-7	92
TYSV2V227H40ML	4-1879309-8	92
TYSV2V227H45ML	4-1879309-9	92
TYSV2V227J35ML	5-1879309-0	92
TYSV2V227J40ML	5-1879309-1	92
TYSV2V227K25ML	5-1879309-2	92

Brand Part No.	Tyco Part No.	Page No.
TYSV2V227K30ML	5-1879309-3	92
TYSV2V277H45ML	5-1879309-4	92
TYSV2V277J35ML	5-1879309-5	92
TYSV2V277J40ML	5-1879309-6	92
TYSV2V277K30ML	5-1879309-7	92
TYSV2V277K35ML	5-1879309-8	92
TYSV2V277L25ML	5-1879309-9	92
TYSV2V337H50ML	6-1879309-0	92
TYSV2V337J40ML	6-1879309-1	92
TYSV2V337J45ML	6-1879309-2	92
TYSV2V337K35ML	6-1879309-3	92
TYSV2V337K40ML	6-1879309-4	92
TYSV2V337L30ML	6-1879309-5	92
TYSV2V397J45ML	6-1879309-6	92
TYSV2V397K35ML	6-1879309-7	92
TYSV2V397K40ML	6-1879309-8	92
TYSV2V397L30ML	6-1879309-9	92
TYSV2V397L35ML	7-1879309-0	92
TYSV2V477K40ML	7-1879309-1	92
TYSV2V477K45ML	7-1879309-2	92
TYSV2V477L30ML	7-1879309-3	92
TYSV2V567K45ML	7-1879309-5	92
TYSV2V567L35ML	7-1879309-6	92
TYSV2V567L40ML	7-1879309-7	92
TYSV2V687L45ML	7-1879309-8	92
TYSV2V826H25ML	3-1879309-4	92
TYSV2W107H35ML	2-1879310-2	92
TYSV2W107J25ML	2-1879310-3	92
TYSV2W127H35ML	2-1879310-4	92
TYSV2W127H40ML	2-1879310-5	92
TYSV2W127J30ML	2-1879310-6	92
TYSV2W127K25ML	2-1879310-7	92
TYSV2W157J40ML	3-1879310-0	92
TYSV2W157K30ML	3-1879310-1	92
TYSV2W157K35ML		

Brand Part No.	Tyco Part No.	Page No.
TYTMA0G335MTRF	9-1676903-0	9
TYTMA0G336KTRF	1-1879055-1	9
TYTMA0G336MTRF	2-1676903-8	9
TYTMA0G475KTRF	1-1879055-2	9
TYTMA0G475MTRF	2-1676903-1	9
TYTMA0G476KTRF	1-1879055-3	9
TYTMA0G476MTRF	3-1676903-0	9
TYTMA0G685KTRF	1-1879055-4	9
TYTMA0G685MTRF	2-1676903-2	9
TYTMA0J105KTRF	1-1879055-5	9
TYTMA0J105MTRF	9-1676903-1	9
TYTMA0J106KTRF	1-1879055-6	9
TYTMA0J106MTRF	4-1676903-7	9
TYTMA0J155KTRF	1-1879055-7	9
TYTMA0J155MTRF	9-1676903-2	9
TYTMA0J156KTRF	1-1879055-8	9
TYTMA0J156MTRF	4-1676903-9	9
TYTMA0J225KTRF	1-1879055-9	9
TYTMA0J225MTRF	9-1676903-3	9
TYTMA0J226KTRF	2-1879055-0	9
TYTMA0J226MTRF	5-1676903-1	9
TYTMA0J335KTRF	2-1879055-1	9
TYTMA0J335MTRF	4-1676903-4	9
TYTMA0J336KTRF	2-1879055-2	9
TYTMA0J336MTRF	5-1676903-3	9
TYTMA0J475KTRF	2-1879055-3	9
TYTMA0J475MTRF	4-1676903-5	9
TYTMA0J685KTRF	2-1879055-4	9
TYTMA0J685MTRF	4-1676903-6	9
TYTMA1A105KTRF	2-1879055-5	9
TYTMA1A105MTRF	9-1676903-4	9
TYTMA1A106KTRF	2-1879055-6	9
TYTMA1A106MTRF	7-1676903-3	9
TYTMA1A155KTRF	2-1879055-7	9
TYTMA1A155MTRF	9-1676903-5	9
TYTMA1A156KTRF	2-1879055-8	9
TYTMA1A156MTRF	7-1676903-5	9
TYTMA1A225KTRF	2-1879055-9	9
TYTMA1A225MTRF	6-1676903-8	9
TYTMA1A335KTRF	3-1879055-0	9
TYTMA1A335MTRF	6-1676903-9	9
TYTMA1A475KTRF	3-1879055-1	9
TYTMA1A475MTRF	7-1676903-0	9
TYTMA1A685KTRF	3-1879055-2	9
TYTMA1A685MTRF	7-1676903-1	9
TYTMA1C105KTRF	3-1879055-3	9
TYTMA1C105MTRF	6-1676904-7	9
TYTMA1C106KTRF	3-1879055-4	9
TYTMA1C106MTRF	1676904-8	9
TYTMA1C155KTRF	3-1879055-5	9
TYTMA1C155MTRF	1676904-1	9
TYTMA1C225KTRF	3-1879055-6	9
TYTMA1C225MTRF	1676904-2	9
TYTMA1C335KTRF	3-1879055-7	9
TYTMA1C335MTRF	1676904-3	9
TYTMA1C475KTRF	3-1879055-8	9
TYTMA1C475MTRF	1676904-4	9
TYTMA1C685KTRF	3-1879055-9	9
TYTMA1C685MTRF	1676904-5	9
TYTMA1D105KTRF	4-1879055-0	9
TYTMA1D105MTRF	2-1676904-0	9
TYTMA1D155KTRF	4-1879055-1	9
TYTMA1D155MTRF	2-1676904-1	9
TYTMA1D225KTRF	4-1879055-2	9
TYTMA1D225MTRF	2-1676904-2	9
TYTMA1D335KTRF	4-1879055-3	9
TYTMA1D335MTRF	2-1676904-3	9
TYTMA1D475KTRF	4-1879055-4	9
TYTMA1D475MTRF	2-1676904-4	9
TYTMA1D684KTRF	4-1879055-5	9
TYTMA1D684MTRF	6-1676904-8	9
TYTMA1E105KTRF	4-1879055-6	9
TYTMA1E105MTRF	3-1676904-6	9
TYTMA1E155KTRF	4-1879055-7	9
TYTMA1E155MTRF	3-1676904-7	9
TYTMA1E474KTRF	4-1879055-8	9
TYTMA1E474MTRF	6-1676904-9	9
TYTMA1E684KTRF	4-1879055-9	9
TYTMA1E684MTRF	3-1676904-5	9
TYTMA1H104KTRF	5-1879055-0	9
TYTMA1H104MTRF	7-1676904-1	9

Brand Part No.	Tyco Part No.	Page No.
TYTMA1H154KTRF	5-1879055-1	9
TYTMA1H154MTRF	5-1676904-9	9
TYTMA1H224KTRF	5-1879055-2	9
TYTMA1H224MTRF	6-1676904-0	9
TYTMA1V104KTRF	5-1879055-3	9
TYTMA1V104MTRF	7-1676904-4	9
TYTMA1V105KTRF	5-1879055-4	9
TYTMA1V105MTRF	4-1676904-9	9
TYTMA1V154KTRF	5-1879055-5	9
TYTMA1V154MTRF	7-1676904-5	9
TYTMA1V224KTRF	5-1879055-6	9
TYTMA1V224MTRF	7-1676904-6	9
TYTMA1V334KTRF	5-1879055-7	9
TYTMA1V334MTRF	7-1676904-7	9
TYTMA1V474KTRF	5-1879055-8	9
TYTMA1V474MTRF	4-1676904-7	9
TYTMA1V684KTRF	5-1879055-9	9
TYTMA1V684MTRF	4-1676904-8	9
TYTMB0E107KTRF	6-1879055-0	9
TYTMB0E107MTRF	1-1676903-2	9
TYTMB0E157KTRF	6-1879055-1	9
TYTMB0E157MTRF	1-1676903-4	9
TYTMB0E226KTRF	6-1879055-2	9
TYTMB0E226MTRF	1676903-5	9
TYTMB0E336KTRF	6-1879055-3	9
TYTMB0E336MTRF	1676903-7	9
TYTMB0E476KTRF	6-1879055-4	9
TYTMB0E476MTRF	1676903-9	9
TYTMB0E686KTRF	6-1879055-5	9
TYTMB0E686MTRF	1-1676903-0	9
TYTMB0G107KTRF	6-1879055-6	9
TYTMB0G107MTRF	3-1676903-5	9
TYTMB0G156KTRF	6-1879055-7	9
TYTMB0G156MTRF	2-1676903-5	9
TYTMB0G226KTRF	6-1879055-8	9
TYTMB0G226MTRF	2-1676903-7	9
TYTMB0G336KTRF	6-1879055-9	9
TYTMB0G336MTRF	2-1676903-9	9
TYTMB0G476KTRF	7-1879055-0	9
TYTMB0G476MTRF	3-1676903-1	9
TYTMB0G686KTRF	7-1879055-1	9
TYTMB0G686MTRF	3-1676903-3	9
TYTMB0J106KTRF	7-1879055-2	9
TYTMB0J106MTRF	4-1676903-8	9
TYTMB0J107KTRF	7-1879055-3	9
TYTMB0J107MTRF	6-1676903-1	9
TYTMB0J156KTRF	7-1879055-4	9
TYTMB0J156MTRF	5-1676903-0	9
TYTMB0J226KTRF	7-1879055-5	9
TYTMB0J226MTRF	5-1676903-2	9
TYTMB0J336KTRF	7-1879055-6	9
TYTMB0J336MTRF	5-1676903-4	9
TYTMB0J476KTRF	7-1879055-7	9
TYTMB0J476MTRF	5-1676903-6	9
TYTMB0J686KTRF	7-1879055-8	9
TYTMB0J686MTRF	5-1676903-8	9
TYTMB1A106KTRF	7-1879055-9	9
TYTMB1A106MTRF	7-1676903-4	9
TYTMB1A156KTRF	8-1879055-0	9
TYTMB1A156MTRF	7-1676903-6	9
TYTMB1A226KTRF	8-1879055-1	9
TYTMB1A226MTRF	7-167903-7	9
TYTMB1A336KTRF	8-1879055-2	9
TYTMB1A336MTRF	7-1676903-9	9
TYTMB1A476KTRF	8-1879055-3	9
TYTMB1A476MTRF	8-1676903-1	9
TYTMB1A685KTRF	8-1879055-4	9
TYTMB1A685MTRF	7-167903-2	9
TYTMB1C106KTRF	8-1879055-5	9
TYTMB1C106MTRF	1676904-9	9
TYTMB1C156KTRF	8-1879055-6	9
TYTMB1C156MTRF	1-1676904-0	9
TYTMB1C226KTRF	8-1879055-7	9
TYTMB1C226MTRF	1-1676904-2	9
TYTMB1C335KTRF	8-1879055-8	9
TYTMB1C335MTRF	7-1676904-8	9
TYTMB1C475KTRF	8-1879055-9	9
TYTMB1C475MTRF	1676904-5	9
TYTMB1C685KTRF	9-1879055-0	9
TYTMB1C685MTRF	1676904-7	9
TYTMB1D106KTRF	1879056-1	9

Brand Part No.	Tyco Part No.	Page No.
TYTMB1D106MTRF	2-1676904-8	9
TYTMB1D155KTRF	1879056-2	9
TYTMB1D155MTRF	7-1676904-9	9
TYTMB1D225KTRF	1879056-3	9
TYTMB1D225MTRF	8-1676904-0	9
TYTMB1D335KTRF	1879056-4	9
TYTMB1D335MTRF	2-1676904-4	9
TYTMB1D475KTRF	1879056-5	9
TYTMB1D475MTRF	2-1676904-6	9
TYTMB1E155KTRF	1879056-6	9
TYTMB1E155MTRF	8-1676904-1	9
TYTMB1E225KTRF	1879056-8	9
TYTMB1E225MTRF	3-1676904-8	9
TYTMB1E475KTRF	1879056-9	9
TYTMB1E475MTRF	2-1676904-7	9
TYTMB1E685KTRF	1-1879056-0	9
TYTMB1E685MTRF	4-1676904-9	9
TYTMB1H154KTRF	1-1879056-1	9
TYTMB1H154MTRF	8-1676904-2	9
TYTMB1H225KTRF	1-1879056-2	9
TYTMB1H224MTRF	8-1676904-3	9
TYTMB1H334KTRF	1-1879056-3	9
TYTMB1H334MTRF	8-1676904-4	9
TYTMB1H474KTRF	1-1879056-4	9
TYTMB1H474MTRF	6-1676904-1	9
TYTMB1H684KTRF	1-1879056-5	9
TYTMB1H684MTRF	6-1676904-2	9
TYTMB1V105KTRF	1-1879056-6	9
TYTMB1V105MTRF	8-1676904-5	9
TYTMB1V155KTRF	1-1879056-7	9
TYTMB1V155MTRF	5-1676904-0	9
TYTMB1V225KTRF	1-1879056-8	9
TYTMB1V225MTRF	5-1676904-1	9
TYTMB1V335KTRF	1-1879056-9	9
TYTMB1V335MTRF	5-1676904-2	9
TYTMB1V474KTRF	2-1879056-0	9
TYTMB1V474MTRF	8-1676904-6	9
TYTMC0E107KTRF	2-1879056-1	9
TYTMC0E107MTRF	1-1676903-3	9
TYTMC0E157KTRF	2-1879056-2	9
TYTMC0E157MTRF	1-1676903-5	9
TYTMC0E227KTRF	2-1879056-3	9
TYTMC0E227MTRF	1-1676903-7	9
TYTMC0E686KTRF	2-1879056-4	9
TYTMC0E686MTRF	1-1676903-1	9
TYTMC0G107KTRF	2-1879056-5	9
TYTMC0G107MTRF	3-1676903-6	9
TYTMC0G157KTRF	2-1879056-6	9
TYTMC0G157MTRF	3-1676903-8	9
TYTMC0G227KTRF	2-1879056-7	9
TYTMC0G227MTRF	4-1676903-0	9
TYTMC0G336KTRF	2-1879056-8	9
TYTMC0G336MTRF	9-1676903-7	9
TYTMC0G476KTRF	2-1879056-9	9
TYTMC0G476MTRF	3-1676903-2	9
TYTMC0G686KTRF	3-1879056-0	9
TYTMC0G686MTRF	3-1676903-4	9
TYTMC0J107KTRF	3-1879056-1	9
TYTMC0J107MTRF	6-1676903-2	9
TYTMC0J157KTRF	3-1879056-2	9
TYTMC0J157MTRF	6-1676903-4	9
TYTMC0J336KTRF	3-1879056-3	9
TYTMC0J336MTRF	5-1676903-5	9
TYTMC0J476KTRF	3-1879056-4	9
TYTMC0J476MTRF	5-1676903-7	9
TYTMC0J686KTRF	3-1879056-5	9
TYTMC0J686MTRF	5-1676903-9	9
TYTMC1A107KTRF	3-1879056-6	9
TYTMC1A107MTRF	8-1676903-6	9
TYTMC1A156KTRF	3-1879056-7	9
TYTMC1A156MTRF	9-1676903-8	9
TYTMC1A226KTRF	3-1879056-8	9
TYTMC1A226MTRF	7-1676903-8	9
TYTMC1A336KTRF	3-1879056-9	9
TYTMC1A336MTRF	8-1676903-0	9
TYTMC1A476KTRF	4-1879056-0	9
TYTMC1A476MTRF	8-1676903-2	9
TYTMC1A686KTRF	4-1879056-1	9
TYTMC1A686MTRF	8-1676903-4	9

Brand Part No.	Tyco Part No.	Page No.
TYTMC1C106KTRF	4-1879056-2	9
TYTMC1C106MTRF	8-1676904-7	9
TYTMC1C156KTRF	4-1879056-3	9
TYTMC1C156MTRF	1-1676904-1	9
TYTMC1C226KTRF	4-1879056-4	9
TYTMC1C226MTRF	1-1676904-3	9
TYTMC1C336KTRF	4-1879056-5	9
TYTMC1C336MTRF	1-1676904-4	9
TYTMC1C476KTRF	4-1879056-6	9
TYTMC1C476MTRF	1-1676904-6	9
TYTMC1D106KTRF	4-1879056-7	9
TYTMC1D106MTRF	2-1676904-9	9
TYTMC1D156KTRF	4-1879056-8	9
TYTMC1D156MTRF	3-1676904-0	9
TYTMC1D226KTRF	4-1879056-9	9
TYTMC1D226MTRF	3-1676904-1	9
TYTMC1D336KTRF	5-1879056-0	9
TYTMC1D336MTRF	8-1676904-8	9
TYTMC1D685KTRF	5-1879056-1	9
TYTMC1D685MTRF	8-1676904-9	9
TYTMC1E106KTRF	5-1879056-2	9
TYTMC1E106MTRF	4-1676904-2	9
TYTMC1E156KTRF	5-1879056-3	9
TYTMC1E156MTRF	4-1676904-3	9
TYTMC1E475KTRF	5-1879056-4	9
TYTMC1E475MTRF	9-1676904-0	9
TYTMC1E685KTRF	5-1879056-5	9
TYTMC1E685MTRF	4-1676904-1	9
TYTMC1H105KTRF	5-1879056-6	9
TYTMC1H105MTRF	9-1676904-1	9
TYTMC1H155KTRF	5-1879056-7	9
TYTMC1H155MTRF	6-1676904-3	9
TYTMC1H225KTRF	5-1879056-8	9
TYTMC1H225MTRF	6-1676904-4	9
TYTMC1H474KTRF	5-1879056-9	9
TYTMC1H474MTRF	9-1676904-3	9
TYTMC1H684KTRF		

Brand Part No.	Tyco Part No.	Page No.
TYTMD1A157MTRF	8-1676903-8	9
TYTMD1A227KTRF	8-1879056-3	9
TYTMD1A227MTRF	8-1676903-9	9
TYTMD1A336KTRF	8-1879056-4	9
TYTMD1A336MTRF	9-1676903-9	9
TYTMD1A476KTRF	8-1879056-5	9
TYTMD1A476MTRF	8-1676903-3	9
TYTMD1A686KTRF	8-1879056-6	9
TYTMD1A686MTRF	8-1676903-5	9
TYTMD1C107KTRF	1879057-1	9
TYTMD1C107MTRF	1-1676904-9	9
TYTMD1C226KTRF	1879057-2	9
TYTMD1C226MTRF	1879054-1	9
TYTMD1C336KTRF	1879057-3	9
TYTMD1C336MTRF	1-1676904-5	9
TYTMD1C476KTRF	1879057-4	9
TYTMD1C476MTRF	1-1676904-7	9
TYTMD1C686KTRF	1879057-5	9
TYTMD1C686MTRF	1-1676904-8	9
TYTMD1D226KTRF	1879057-6	9
TYTMD1D226MTRF	3-1676904-2	9
TYTMD1D336KTRF	1879057-7	9
TYTMD1D336MTRF	3-1676904-3	9
TYTMD1D476KTRF	1879057-8	9
TYTMD1D476MTRF	3-1676904-4	9
TYTMD1E106KTRF	1879057-9	9
TYTMD1E106MTRF	1879054-2	9
TYTMD1E156KTRF	1-1879057-0	9
TYTMD1E156MTRF	4-1676904-4	9
TYTMD1E226KTRF	1-1879057-1	9
TYTMD1E226MTRF	4-1676904-5	9
TYTMD1E336KTRF	1-1879057-2	9
TYTMD1E336MTRF	4-1676904-6	9
TYTMD1E476KTRF	1-1879057-3	9
TYTMD1E476MTRF	1879054-3	9
TYTMD1H155KTRF	1-1879057-4	9
TYTMD1H155MTRF	1879054-4	9
TYTMD1H225KTRF	1-1879057-5	9
TYTMD1H225MTRF	1879054-5	9
TYTMD1H335KTRF	1-1879057-6	9
TYTMD1H335MTRF	6-1676904-5	9
TYTMD1H475KTRF	1-1879057-7	9
TYTMD1H475MTRF	6-1676904-6	9
TYTMD1H685KTRF	1-1879057-8	9
TYTMD1H685MTRF	1879054-6	9
TYTMD1V106KTRF	1-1879057-9	9
TYTMD1V106MTRF	5-1676904-6	9
TYTMD1V156KTRF	2-1879057-0	9
TYTMD1V156MTRF	5-1676904-7	9
TYTMD1V226KTRF	2-1879057-1	9
TYTMD1V226MTRF	5-1676904-8	9
TYTMD1V335KTRF	2-1879057-2	9
TYTMD1V335MTRF	1879054-7	9
TYTMD1V475KTRF	2-1879057-3	9
TYTMD1V475MTRF	1879054-8	9
TYTMD1V685KTRF	2-1879057-4	9
TYTMD1V685MTRF	1879054-9	9
TYTME1A157KTRF	6-1879058-1	9
TYTME1A157MTRF	6-1879058-2	9
TYTME1C107KTRF	6-1879058-3	9
TYTME1C107MTRF	6-1879058-4	9
TYTME1C157KTRF	6-1879058-5	9
TYTME1C157MTRF	6-1879058-6	9
TYTME1D336KTRF	6-1879058-7	9
TYTME1D336MTRF	6-1879058-8	9
TYTME1D476KTRF	6-1879058-9	9
TYTME1D476MTRF	7-1879058-0	9
TYTME1E336KTRF	7-1879058-1	9
TYTME1E336MTRF	7-1879058-2	9
TYTME1E476KTRF	7-1879058-3	9
TYTME1E476MTRF	7-1879058-4	9
TYTME1H106KTRF	7-1879058-5	9
TYTME1H106MTRF	7-1879058-6	9
TYTME1H225KTRF	7-1879058-7	9
TYTME1H225MTRF	7-1879058-8	9
TYTME1H685KTRF	7-1879058-9	9
TYTME1H685MTRF	8-1879058-0	9
TYTME1V156KTRF	8-1879058-1	9
TYTME1V156MTRF	8-1879058-2	9
TYTME1V226KTRF	8-1879058-3	9
TYTME1V226MTRF	8-1879058-4	9

Brand Part No.	Tyco Part No.	Page No.
TYTPOE106KTRF	2-1879057-5	15
TYTPOE106MTRF	1676906-5	15
TYTPOE156KTRF	2-1879057-6	15
TYTPOE156MTRF	1676906-6	15
TYTPOE225KTRF	2-1879057-7	15
TYTPOE225MTRF	1676906-1	15
TYTPOE226KTRF	2-1879057-8	15
TYTPOE226MTRF	1676906-7	15
TYTPOE335KTRF	2-1879057-9	15
TYTPOE335MTRF	1676906-2	15
TYTPOE475KTRF	3-1879057-0	15
TYTPOE475MTRF	1676906-3	15
TYTPOE685KTRF	3-1879057-1	15
TYTPOE685MTRF	1676906-4	15
TYTPOG106KTRF	3-1879057-2	15
TYTPOG106MTRF	1-1676906-3	15
TYTPOG155KTRF	3-1879057-3	15
TYTPOG155MTRF	1676906-8	15
TYTPOG225KTRF	3-1879057-4	15
TYTPOG225MTRF	1676906-9	15
TYTPOG335KTRF	3-1879057-5	15
TYTPOG335MTRF	1-1676906-5	15
TYTPOG475KTRF	3-1879057-6	15
TYTPOG475MTRF	1-1676906-6	15
TYTPOG685KTRF	3-1879057-7	15
TYTPOG685MTRF	1-1676906-7	15
TYTPOJ105KTRF	4-1879057-0	15
TYTPOJ105MTRF	1-1676906-6	15
TYTPOJ106KTRF	4-1879057-1	15
TYTPOJ106MTRF	2-1676906-2	15
TYTPOJ155KTRF	4-1879057-2	15
TYTPOJ155MTRF	1-1676906-7	15
TYTPOJ225KTRF	4-1879057-3	15
TYTPOJ225MTRF	1-1676906-8	15
TYTPOJ335KTRF	4-1879057-4	15
TYTPOJ335MTRF	1-1676906-9	15
TYTPOJ475KTRF	4-1879057-5	15
TYTPOJ475MTRF	2-1676906-0	15
TYTPOJ685KTRF	4-1879057-6	15
TYTPOJ685MTRF	2-1676906-1	15
TYTPP1A105KTRF	4-1879057-7	15
TYTPP1A105MTRF	2-1676906-4	15
TYTPP1A155KTRF	4-1879057-8	15
TYTPP1A155MTRF	2-1676906-5	15
TYTPP1A225KTRF	4-1879057-9	15
TYTPP1A225MTRF	2-1676906-6	15
TYTPP1A335KTRF	5-1879057-0	15
TYTPP1A335MTRF	2-1676906-7	15
TYTPP1A475KTRF	5-1879057-1	15
TYTPP1A475MTRF	2-1676906-8	15
TYTPP1A684KTRF	5-1879057-2	15
TYTPP1A684MTRF	2-1676906-3	15
TYTPP1C105KTRF	3-1676906-1	15
TYTPP1C105MTRF	5-1879057-4	15
TYTPP1C474KTRF	5-1879057-5	15
TYTPP1C474MTRF	2-1676906-9	15
TYTPP1C684KTRF	5-1879057-6	15
TYTPP1C684MTRF	3-1676906-0	15
TYTPP1D104KTRF	5-1879057-7	15
TYTPP1D104MTRF	3-1676906-2	15
TYTPP1D154KTRF	5-1879057-8	15
TYTPP1D154MTRF	3-1676906-3	15
TYTPP1D224KTRF	5-1879057-9	15
TYTPP1D224MTRF	3-1676906-4	15
TYTPP1D334KTRF	5-1879057-0	15
TYTPP1D334MTRF	3-1676906-5	15
TYTPP1D474KTRF	6-1879057-0	15
TYTPP1D474MTRF	3-1676906-6	15
TYTPP1D684KTRF	6-1879057-1	15
TYTPP1D684MTRF	3-1676906-7	15
TYTPP1E473KTRF	6-1879057-2	15
TYTPP1E473MTRF	3-1676906-8	15
TYTPP1E683KTRF	6-1879057-3	15
TYTPP1E683MTRF	3-1676906-9	15
TYTRA0G106KTRF	8-1879058-5	18
TYTRA0G106MTRF	8-1879058-6	18
TYTRA0G156KTRF	8-1879058-7	18

Brand Part No.	Tyco Part No.	Page No.
TYTRA0G156MTRF	8-1879058-8	18
TYTRA0G226KTRF	8-1879058-9	18
TYTRA0G226MTRF	9-1879058-0	18
TYTRA0G335KTRF	9-1879058-1	18
TYTRA0G335MTRF	9-1879058-2	18
TYTRA0G475KTRF	9-1879058-3	18
TYTRA0G475MTRF	9-1879058-4	18
TYTRA0G685KTRF	9-1879058-5	18
TYTRA0G685MTRF	9-1879058-6	18
TYTRA0J106KTRF	1879062-1	18
TYTRA0J106MTRF	1879062-2	18
TYTRA0J156KTRF	1879062-3	18
TYTRA0J156MTRF	1879062-4	18
TYTRA0J225KTRF	1879062-5	18
TYTRA0J225MTRF	1879062-6	18
TYTRA0J226KTRF	1879062-7	18
TYTRA0J226MTRF	1879062-8	18
TYTRA0J335KTRF	1879062-9	18
TYTRA0J335MTRF	1-1879062-0	18
TYTRA0J475KTRF	1-1879062-1	18
TYTRA0J475MTRF	1-1879062-2	18
TYTRA0J685KTRF	1-1879062-3	18
TYTRA1A106MTRF	1-1879062-6	18
TYTRA1A155KTRF	1-1879062-7	18
TYTRA1A155MTRF	1-1879062-8	18
TYTRA1A156KTRF	1-1879062-9	18
TYTRA1A156MTRF	2-1879062-0	18
TYTRA1A225KTRF	2-1879062-1	18
TYTRA1A225MTRF	2-1879062-2	18
TYTRA1A335KTRF	2-1879062-3	18
TYTRA1A335MTRF	2-1879062-4	18
TYTRA1A475KTRF	2-1879062-5	18
TYTRA1A475MTRF	2-1879062-6	18
TYTRA1A685KTRF	2-1879062-7	18
TYTRA1A685MTRF	2-1879062-8	18
TYTRA1C105KTRF	2-1879062-9	18
TYTRA1C105MTRF	3-1879062-0	18
TYTRA1C106KTRF	3-1879062-1	18
TYTRA1C106MTRF	3-1879062-2	18
TYTRA1C155KTRF	3-1879062-3	18
TYTRA1C155MTRF	3-1879062-4	18
TYTRA1C225KTRF	3-1879062-5	18
TYTRA1C225MTRF	3-1879062-6	18
TYTRA1C335KTRF	3-1879062-7	18
TYTRA1C335MTRF	3-1879062-8	18
TYTRA1C475KTRF	3-1879062-9	18
TYTRA1C475MTRF	4-1879062-0	18
TYTRA1C685KTRF	4-1879062-1	18
TYTRA1C685MTRF	4-1879062-2	18
TYTRA1D105KTRF	4-1879062-3	18
TYTRA1D105MTRF	4-1879062-4	18
TYTRA1D155KTRF	4-1879062-5	18
TYTRA1D155MTRF	4-1879062-6	18
TYTRA1D225KTRF	4-1879062-7	18
TYTRA1D225MTRF	4-1879062-8	18
TYTRA1D335KTRF	4-1879062-9	18
TYTRA1D335MTRF	5-1879062-0	18
TYTRA1D475KTRF	5-1879062-1	18
TYTRA1D475MTRF	5-1879062-2	18
TYTRA1D684KTRF	5-1879062-3	18
TYTRA1D684MTRF	5-1879062-4	18
TYTRA1E105KTRF	5-1879062-5	18
TYTRA1E105MTRF	5-1879062-6	18
TYTRA1E155KTRF	5-1879062-7	18
TYTRA1E155MTRF	5-1879062-8	18
TYTRA1E474KTRF	5-1879062-9	18
TYTRA1E474MTRF	6-1879062-0	18
TYTRA1E684KTRF	6-1879062-1	18
TYTRA1E684MTRF	6-1879062-2	18
TYTRA1H104KTRF	6-1879062-3	18
TYTRA1H104MTRF	6-1879062-4	18
TYTRA1H154KTRF	6-1879062-5	18
TYTRA1H154MTRF	6-1879062-6	18
TYTRA1V104KTRF	6-1879062-7	18
TYTRA1V104MTRF	6-1879062-8	18
TYTRA1V105KTRF	6-1879062-9	18
TYTRA1V105MTRF	7-1879062-0	18
TYTRA1V154KTRF	7-1879062-1	18
TYTRA1V154MTRF	7-1879062-2	18

Brand Part No.	Tyco Part No.	Page No.
TYTRA1V224KTRF	7-1879062-3	18
TYTRA1V224MTRF	7-1879062-4	18
TYTRA1V334KTRF	7-1879062-5	18
TYTRA1V334MTRF	7-1879062-6	18
TYTRA1V474KTRF	7-1879062-7	18
TYTRA1V474MTRF	7-1879062-8	18
TYTRA1V684KTRF	7-1879062-9	18
TYTRA1V684MTRF	8-1879062-0	18
TYTRB0G106KTRF	1879063-1	18
TYTRB0G106MTRF	1879063-2	18
TYTRB0G107KTRF	1879063-3	18
TYTRB0G107MTRF	1879063-4	18
TYTRB0G156KTRF	1879063-5	18
TYTRB0G156MTRF	1879063-6	18
TYTRB0G226KTRF	1879063-7	18
TYTRB0G226MTRF	1879063-8	18
TYTRB0G336KTRF	1879063-9	18
TYTRB0G336MTRF	1-1879063-0	18
TYTRB0G476KTRF	1-1879063-1	18
TYTRB0G476MTRF	1-1879063-2	18
TYTRB0G686KTRF	1-1879063-3	18
TYTRB0G686MTRF	1-1879063-4	18
TYTRB0J106KTRF	6-1879057-4	18
TYTRB0J106MTRF	1676909-0	18
TYTRB0J156KTRF	6-1879057-5	18
TYTRB0J156MTRF	1676909-2	18
TYTRB0J226KTRF	6-1879057-6	18
TYTRB0J226MTRF	1676909-3	18
TYTRB0J336KTRF	1-1879063-5	18
TYTRB0J336MTRF	1-1879063-6	18
TYTRB0J476KTRF	1-1879063-7	18
TYTRB0J476MTRF	1-1879063-8	18
TYTRB0J685KTRF	1-1879063-9	18
TYTRB0J685MTRF	2-1879063-0	18
TYTRB1A106KTRF	6-1879057-7	18
TYTRB1A106MTRF	1-1676909-1	18
TYTRB1A156KTRF	6-1879057-8	18
TYTRB1A156MTRF	6-187909-2	18
TYTRB1A226KTRF	2-1879063-1	18
TYTRB1A226MTRF	2-1879063-2	18
TYTRB1A		

Brand Part No.	Tyco Part No.	Page No.
TYTRB1H334MTRF	6-1879063-2	18
TYTRB1H474KTRF	6-1879063-3	18
TYTRB1H474MTRF	6-1879063-4	18
TYTRB1H684KTRF	6-1879063-5	18
TYTRB1H684MTRF	6-1879063-6	18
TYTRB1V105KTRF	6-1879063-7	18
TYTRB1V105MTRF	6-1879063-8	18
TYTRB1V155KTRF	6-1879063-9	18
TYTRB1V155MTRF	7-1879063-0	18
TYTRB1V225KTRF	7-1879063-1	18
TYTRB1V225MTRF	7-1879063-2	18
TYTRB1V335KTRF	7-1879063-3	18
TYTRB1V335MTRF	7-1879063-4	18
TYTRB1V474KTRF	7-1879063-5	18
TYTRB1V474MTRF	7-1879063-6	18
TYTRB1V684KTRF	7-1879063-7	18
TYTRB1V684MTRF	7-1879063-8	18
TYTRCOG107KTRF	1879064-1	18
TYTRCOG107MTRF	1879064-2	18
TYTRCOG157KTRF	1879064-3	18
TYTRCOG157MTRF	1879064-4	18
TYTRCOG336KTRF	1879064-5	18
TYTRCOG336MTRF	1879064-6	18
TYTRCOG476KTRF	1879064-7	18
TYTRCOG476MTRF	1879064-8	18
TYTRCOG686KTRF	1879064-9	18
TYTRCOG686MTRF	1-1879064-0	18
TYTRCOJ107KTRF	1-1879064-1	18
TYTRCOJ107MTRF	1-1879064-2	18
TYTRCOJ157KTRF	1-1879064-3	18
TYTRCOJ157MTRF	1-1879064-4	18
TYTRCOJ226KTRF	1-1879064-5	18
TYTRCOJ226MTRF	1-1879064-6	18
TYTRCOJ336KTRF	7-1879057-0	18
TYTRCOJ336MTRF	1676909-4	18
TYTRCOJ476KTRF	7-1879057-1	18
TYTRCOJ476MTRF	1676909-5	18
TYTRCOJ686KTRF	1-1879064-7	18
TYTRCOJ686MTRF	1-1879064-8	18
TYTRC1A107KTRF	1-1879064-9	18
TYTRC1A107MTRF	2-1879064-0	18
TYTRC1A156KTRF	2-1879064-1	18
TYTRC1A156MTRF	2-1879064-2	18
TYTRC1A226KTRF	7-1879057-2	18
TYTRC1A226MTRF	1-1676909-3	18
TYTRC1A336KTRF	7-1879057-3	18
TYTRC1A336MTRF	1-1676909-4	18
TYTRC1A476KTRF	2-1879064-3	18
TYTRC1A476MTRF	2-1879064-4	18
TYTRC1A686KTRF	2-1879064-5	18
TYTRC1A686MTRF	2-1879064-6	18
TYTRC1C106KTRF	2-1879064-7	18
TYTRC1C106MTRF	2-1879064-8	18
TYTRC1C156KTRF	7-1879057-4	18
TYTRC1C156MTRF	2-1676909-1	18
TYTRC1C226KTRF	7-1879057-5	18
TYTRC1C226MTRF	2-1676909-2	18
TYTRC1C336KTRF	2-1879064-9	18
TYTRC1C336MTRF	3-1879064-0	18
TYTRC1C476KTRF	3-1879064-1	18
TYTRC1C476MTRF	3-1879064-2	18
TYTRC1D106KTRF	7-1879057-6	18
TYTRC1D106MTRF	2-1676909-7	18
TYTRC1D156KTRF	7-1879057-7	18
TYTRC1D156MTRF	2-1676909-8	18
TYTRC1D226KTRF	3-1879064-3	18
TYTRC1D226MTRF	3-1879064-4	18
TYTRC1D685KTRF	3-1879064-5	18
TYTRC1D685MTRF	3-1879064-6	18
TYTRC1E106KTRF	3-1879064-7	18
TYTRC1E106MTRF	3-1879064-8	18
TYTRC1E156KTRF	3-1879064-9	18
TYTRC1E156MTRF	4-1879064-0	18
TYTRC1E475KTRF	4-1879064-1	18
TYTRC1E475MTRF	4-1879064-2	18
TYTRC1E685KTRF	4-1879064-3	18
TYTRC1E685MTRF	4-1879064-4	18
TYTRC1H105KTRF	4-1879064-5	18
TYTRC1H105MTRF	4-1879064-6	18
TYTRC1H155KTRF	4-1879064-7	18
TYTRC1H155MTRF	4-1879064-8	18

Brand Part No.	Tyco Part No.	Page No.
TYTRC1H225KTRF	4-1879064-9	18
TYTRC1H225MTRF	5-1879064-0	18
TYTRC1H474KTRF	5-1879064-1	18
TYTRC1H474MTRF	5-1879064-2	18
TYTRC1H684KTRF	5-1879064-3	18
TYTRC1H684MTRF	5-1879064-4	18
TYTRC1V106KTRF	5-1879064-5	18
TYTRC1V106MTRF	5-1879064-6	18
TYTRC1V155KTRF	5-1879064-7	18
TYTRC1V155MTRF	5-1879064-8	18
TYTRC1V225KTRF	5-1879064-9	18
TYTRC1V225MTRF	6-1879064-0	18
TYTRC1V335KTRF	6-1879064-1	18
TYTRC1V335MTRF	6-1879064-2	18
TYTRC1V475KTRF	6-1879064-3	18
TYTRC1V475MTRF	6-1879064-4	18
TYTRC1V685KTRF	6-1879064-5	18
TYTRC1V685MTRF	6-1879064-6	18
TYTRD0G107KTRF	1879065-1	18
TYTRD0G107MTRF	1879065-2	18
TYTRD0G157KTRF	1879065-3	18
TYTRD0G157MTRF	1879065-4	18
TYTRD0G227KTRF	1879065-5	18
TYTRD0G227MTRF	1879065-6	18
TYTRD0G337KTRF	1879065-7	18
TYTRD0G337MTRF	1879065-8	18
TYTRD0G477KTRF	1879065-9	18
TYTRD0G477MTRF	1-1879065-0	18
TYTRD0G686KTRF	1-1879065-1	18
TYTRD0G686MTRF	1-1879065-2	18
TYTRD0J107KTRF	7-1879057-8	18
TYTRD0J107MTRF	1676909-7	18
TYTRD0J157KTRF	7-1879057-9	18
TYTRD0J157MTRF	1676909-8	18
TYTRD0J227KTRF	8-1879057-0	18
TYTRD0J227MTRF	1676909-9	18
TYTRD0J337KTRF	8-1879057-1	18
TYTRD0J337MTRF	1-1676909-0	18
TYTRD0J476KTRF	1-1879065-3	18
TYTRD0J476MTRF	1-1879065-4	18
TYTRD0J686KTRF	8-1879057-2	18
TYTRD0J686MTRF	1676909-6	18
TYTRD1A107KTRF	8-1879057-3	18
TYTRD1A107MTRF	1-1676909-7	18
TYTRD1A157KTRF	8-1879057-4	18
TYTRD1A157MTRF	1-1676909-8	18
TYTRD1A227KTRF	8-1879057-5	18
TYTRD1A227MTRF	1-1676909-9	18
TYTRD1A336KTRF	1-1879065-5	18
TYTRD1A336MTRF	1-1879065-6	18
TYTRD1A476KTRF	8-1879057-6	18
TYTRD1A476MTRF	1-1676909-5	18
TYTRD1A686KTRF	8-1879057-7	18
TYTRD1A686MTRF	1-1676909-6	18
TYTRD1C107KTRF	8-1879057-8	18
TYTRD1C107MTRF	2-1676909-6	18
TYTRD1C226KTRF	1-1879065-7	18
TYTRD1C226MTRF	1-1879065-8	18
TYTRD1C336KTRF	8-1879057-9	18
TYTRD1C336MTRF	2-1676909-3	18
TYTRD1C476KTRF	9-1879057-0	18
TYTRD1C476MTRF	2-1676909-4	18
TYTRD1C686KTRF	9-1879057-1	18
TYTRD1C686MTRF	2-1676909-5	18
TYTRD1D156KTRF	1-1879065-9	18
TYTRD1D156MTRF	2-1879065-0	18
TYTRD1D226KTRF	1879058-1	18
TYTRD1D226MTRF	2-1676909-9	18
TYTRD1D336KTRF	1879058-2	18
TYTRD1D336MTRF	3-1676909-0	18
TYTRD1D476KTRF	1879058-3	18
TYTRD1D476MTRF	3-1676909-1	18
TYTRD1E106KTRF	1879058-4	18
TYTRD1E106MTRF	3-1676909-2	18
TYTRD1E156KTRF	1879058-5	18
TYTRD1E156MTRF	3-1676909-3	18
TYTRD1E226KTRF	1879058-6	18
TYTRD1E226MTRF	3-1676909-4	18
TYTRD1E336KTRF	1879058-7	18
TYTRD1E336MTRF	3-1676909-5	18
TYTRD1H155KTRF	2-1879065-1	18

Brand Part No.	Tyco Part No.	Page No.
TYTRD1H155MTRF	2-1879065-2	18
TYTRD1H225KTRF	2-1879065-3	18
TYTRD1H225MTRF	2-1879065-4	18
TYTRD1H335KTRF	2-1879065-5	18
TYTRD1H335MTRF	2-1879065-6	18
TYTRD1H475KTRF	2-1879065-7	18
TYTRD1H475MTRF	2-1879065-8	18
TYTRD1V106KTRF	1879058-8	18
TYTRD1V106MTRF	3-1676909-6	18
TYTRD1V156KTRF	1879058-9	18
TYTRD1V156MTRF	3-1676909-7	18
TYTRD1V226KTRF	1-1879058-0	18
TYTRD1V226MTRF	3-1676909-8	18
TYTRD1V475KTRF	2-1879065-9	18
TYTRD1V475MTRF	3-1879065-0	18
TYTRD1V685KTRF	3-1879065-1	18
TYTRD1V685MTRF	3-1879065-2	18
TYTRE1A157KTRF	3-1879065-3	18
TYTRE1A157MTRF	1879058-9	18
TYTRE1C107KTRF	3-1879065-5	18
TYTRE1C107MTRF	3-1879065-6	18
TYTRE1C157KTRF	3-1879065-7	18
TYTRE1C157MTRF	3-1879065-8	18
TYTRE1E336KTRF	3-1879065-9	18
TYTRE1E336MTRF	4-1879065-0	18
TYTRE1E476KTRF	4-1879065-1	18
TYTRE1E476MTRF	4-1879065-2	18
TYTRE1H106KTRF	4-1879065-3	18
TYTRE1H106MTRF	4-1879065-4	18
TYTRE1H685KTRF	4-1879065-5	18
TYTRE1H685MTRF	4-1879065-6	18
TYTRE1V156KTRF	4-1879065-7	18
TYTRE1V156MTRF	4-1879065-8	18
TYTRE1V226KTRF	4-1879065-9	18
TYTRE1V226MTRF	5-1879065-0	18
TYTRPOG106KTRF	5-1879065-1	18
TYTRPOG106MTRF	5-1879065-2	18
TYTRPOJ106KTRF	5-1879065-3	18
TYTRPOJ106MTRF	5-1879065-4	18
TYTRPOJ685KTRF	5-1879065-8	18
TYTRPOJ685MTRF	5-1879065-9	18
TYTRP1A475KTRF	5-1879065-6	18
TYTRP1A475MTRF	5-1879065-7	18
TYTSA0G335KTRF	1-1879058-1	6
TYTSA0G335MTRF	1676902-1	6
TYTSA0J225KTRF	1-1879058-2	6
TYTSA0J225MTRF	1676902-5	6
TYTSA1A155KTRF	1-1879058-3	6
TYTSA1A155MTRF	1676902-9	6
TYTSA1C105KTRF	1-1879058-4	6
TYTSA1C105MTRF	1-1676902-3	6
TYTSA1D684KTRF	1-1879058-5	6
TYTSA1D684MTRF	1-1676902-7	6
TYTSA1E474KTRF	1-1879058-6	6
TYTSA1E474MTRF	2-1676902-1	6
TYTSA1H104KTRF	1-1879058-7	6
TYTSA1H104MTRF	3-1676902-7	6
TYTSA1V104KTRF	1-1879058-8	6
TYTSA1V104MTRF	2-1676902-5	6
TYTSA1V154KTRF	1-1879058-9	6
TYTSA1V154MTRF	2-1676902-6	6
TYTSA1V224KTRF	2-1879058-0	6
TYTSA1V224MTRF	2-1676902-7	6
TYTSA1V334KTRF	2-1879058-1	6
TYTSA1V334MTRF	2-1676902-8	6
TYTSB0G106KTRF	2-1879058-2	6
TYTSB0G106MTRF	1676902-2	6
TYTSB0J685KTRF	2-1879058-3	6
TYTSB0J685MTRF	1676902-6	6
TYTSB1A475KTRF	2-1879058-4	6
TYTSB1A475MTRF	1-1676902-0	6
TYTSB1C335KTRF	2-1879058-5	6
TYTSB1C335MTRF	1-1676902-4	6
TYTSB1D225KTRF	2-1879058-6	6
TYTSB1D225MTRF	1-1676902-8	6
TYTSB1E155KTRF	2-1879058-7	6
TYTSB1E155MTRF	2-1676902-2	6
TYTSB1H154KTRF	2-1879058-8	6
TYTSB1H154MTRF	3-1676902-8	6
TYTSB1H224KTRF	2-1879058-9	6
TYTSB1H224MTRF	3-1676902-9	6

Brand Part No.	Tyco Part No.	Page No.
TYTSB1H334KTRF	3-1879058-0	6
TYTSB1H334MTRF	4-1676902-0	6
TYTSB1V105KTRF	3-1879058-1	6
TYTSB1V105MTRF	3-1676902-1	6
TYTSB1V474KTRF	3-1879058-2	6
TYTSB1V474MTRF	2-1676902-9	6
TYTSB1V684KTRF	3-1879058-3	6
TYTSB1V684MTRF	3-1676902-0	6
TYTSC0G336KTRF	3-1879058-4	6
TYTSC0G336MTRF	1676902-3	6
TYTSC0J226KTRF	3-1879058-5	6
TYTSC0J226MTRF	1676902-7	6
TYTSC1A156KTRF	3-1676909-8	6
TYTSC1A156MTRF	1-1676902-1	6
TYTSC1C106KTRF	3-1879058-7	6
TYTSC1C106MTRF	1-1676902-5	6
TYTSC1D685KTRF	3-1879058-8	6
TYTSC1D685MTRF	1-1676902-9	6
TYTSC1E475KTRF	3-1879058-9	6
TYTSC1E475MTRF	2-1676902-3	6
TYTSC1H105KTRF	4-1879058-0	6
TYTSC1H105MTRF	4-1676902-3	6
TYTSC1H474KTRF	4-1879058-1	6
TYTSC1H474MTRF	4-1676902-4	6
TYTSC1H684KTRF	4-1879058-2	6
TYTSC1H684MTRF	4-1676902-2	6
TYTSC1V155KTRF	4-1879058-3	6
TYTSC1V155MTRF	3-1676902-2	6
TYTSC1V225KTRF	4-1879058-4	6
TYTSC1V225MTRF	3-1676902-3	6
TYTSC1V335KTRF	4-1879058-5	6
TYTSC1V335MTRF	3-1676902-	

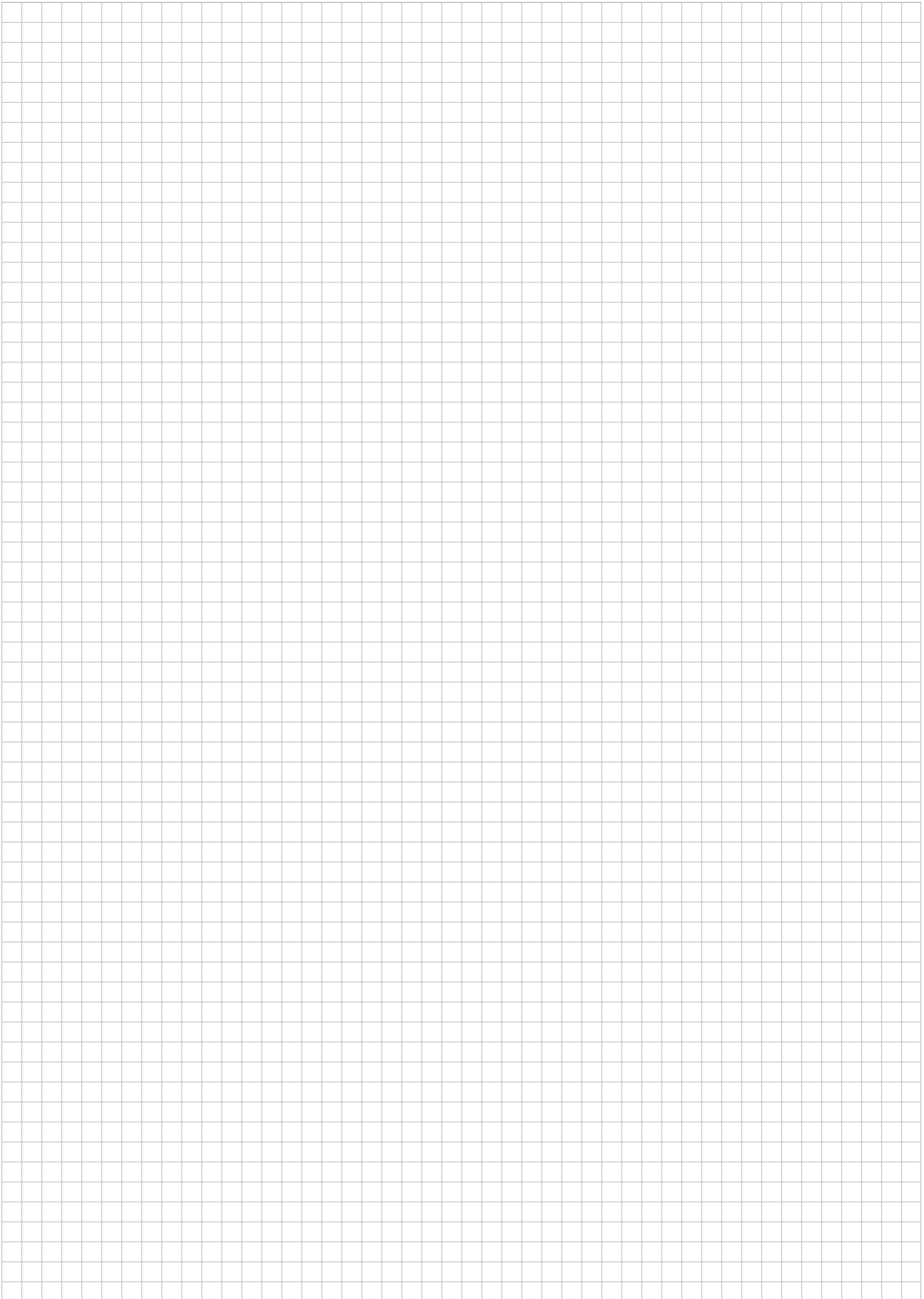

Contacts

Austria – Vienna

Phone: +43-1-905-60-0
Fax: +43-1-905-60-1333
Product Information Center:
Phone: +43-1-905-60-1249
Fax: +43-1-905-60-1251

Belgium – Kessel-Lo

Phone: +32-16-352-300
Fax: +32-16-352-352

Bulgaria – Sofia

Phone: +359-2-971-2152
Fax: +359-2-971-2153

Czech Republic and Slovakia

Czech Republic – Kurim
Phone: +420-541-162-111
Fax: +420-541-162-223
Product Information Center:
Phone: +420-541-162-113
Fax: +420-541-162-132

Denmark – Glostrup

Phone: +45-43-48-04-00
Fax: +45-43-44-14-14

Egypt – Cairo

Phone: +202-419-2334
Fax: +202-417-7647

Estonia – Tartu

Phone: +372-5138-274
Fax: +372-7400-779

Finland – Helsinki

Phone: +358-95-12-34-20
Fax: +358-95-12-34-250

France – Cergy-Pontoise Cedex

Phone: +33-1-3420-8888
Fax: +33-1-3420-8600

Product Information Center:

Phone: +33-1-3420-8686
Fax: +33-1-3420-8623

France Export Divisions –

Cergy-Pontoise Cedex
Phone: +33-1-3420-8804
Fax: +33-1-3420-8699

Germany – Bensheim

Phone: +49-6251-133-0
Fax: +49-6251-133-1600
Product Information Center:
Phone: +49-6251-133-1999
Fax: +49-6251-133-1988

Greece – Athens

Phone: +30-210-9370-396/397
Fax: +30-210-9370-655

Hungary – Budapest

Phone: +36-1-289-1000
Fax: +36-1-289-1010
Product Information Center:
Phone: +36-1-289-1016
Fax: +36-1-289-1017

Ireland – Dublin

Phone: +353-1-866-5612
Fax: +353-1-866-5714

Israel – Petach-Tikva

Phone: +972-3-929-0999
Fax: +972-3-919-1088

Italy – Collegno (Torino)

Phone: +39-011-4012-111
Fax: +39-011-4031-116
Product Information Center:
Phone: +39-011-4012-428
Fax: +39-011-4028-7428

Lithuania and Latvia

Lithuania – Vilnius
Phone: +370-5-213-1402
Fax: +370-5-213-1403
Product Information Center:
Phone: +370-5-211-3016
Fax: +370-5-213-1403

Netherlands – 's-Hertogenbosch

Phone: +31-73-6246-246
Fax: +31-73-6212-365
Product Information Center:
Phone: +31-73-6246-999
Fax: +31-73-6246-998

Norway – Nesbru

Phone: +47-66-77-88-50
Fax: +47-66-77-88-55

Poland – Warsaw

Phone: +48-22-4576-700
Fax: +48-22-4576-720
Product Information Center:
Phone: +48-22-4576-704
Fax: +48-22-4576-720

Romania – Bucharest

Phone: +40-21-311-3479/3596
Fax: +40-21-312-0574

Russia – Moscow

Phone: +7-495-790-7902
Fax: +7-495-721-1893
Product Information Center:
Phone: +7-495-790-7902-404
Fax: +7-495-790-7902-401

Russia – St.Petersburg

Phone: +7-812-718-8192
Fax: +7-812-718-8193

Slovenia – Ljubljana

Phone: +386-1561-3270
Fax: +386-1561-3240

South Africa – Port Elizabeth

Phone: +27-41-503-4500
Fax: +27-41-581-0440

Spain – Barcelona

Phone: +34-93-291-0330
Fax: +34-93-201-7879

Sweden – Upplands Väsby

Phone: +46-8-50-72-50-00
Fax: +46-8-50-72-50-01

Switzerland – Steinach

Phone: +41-71-447-0447
Fax: +41-71-447-0444

Turkey – Istanbul

Phone: +90-212-281-8181/2/3
+90-212-282-5130/5430
Fax: +90-212-281-8184

Ukraine – Kiev

Phone: +380-44-206-2265
Fax: +380-44-206-2264
Product Information Center:
Phone: +380-44-206-2265
Fax: +380-44-206-2264

United Kingdom –

Stanmore, Middlesex
Phone: +44-8706-080208
Fax: +44-208-954-6234
Product Information Center:
Freephone (UK only):
0800-267-666
Phone: +44-8706-080208
Fax: +44-208-420-8095

X-ON Electronics

Largest Supplier of Electrical and Electronic Components

Click to view similar products for [Aluminum Electrolytic Capacitors - SMD category](#):

Click to view products by [TE Connectivity manufacturer](#):

Other Similar products are found below :

[EEV-FK1E332W](#) [ULV2H4R7MNL1GS](#) [ULV2H1R8MNL1GS](#) [22927](#) [NRWA331M63V12.5X20TBF](#) [HUB1800-S](#) [UCX1V471MNQ1MS](#)
[RJ4-400V100MI5#-T4](#) [UCX1V681MNQ1MS](#) [RYK-50V101MG5TT-FL](#) [UCX1V681MNS1MS](#) [UCX1V221MCS1GS](#) [UCX1V101MCS1GS](#)
[107AXZ016MQ5](#) [EXV107M025A9HAA](#) [UCD1V100MCQ1GS](#) [UCX1H471MNQ1MS](#) [107SML016M](#) [EDK226M035A9DAA](#)
[EDT476M050S9MAA](#) [EEV-HA0J152P](#) [EEV-HA1A471UP](#) [EEV-HA1C220WR](#) [EEV-HA1C471P](#) [EEV-HA1E331UP](#) [EEV-HA1H3R3R](#)
[EEV-HA1H470UP](#) [EEV-HA1HR47R](#) [EEV-HA1V470UP](#) [EEV-HB0G221P](#) [EEV-HB0J330R](#) [EEV-HB1E220P](#) [UCX1H821MNQ1MS](#)
[UCX1H561MNS1MS](#) [UCX1H471MNS1MS](#) [UCX1H102MNQ1MS](#) [UCX1E332MNS1MS](#) [HZA277M035G24T-F](#) [TYEH1V337H10MTR](#)
[EDT107M035S9MAA](#) [BMVK100ADA330MF60G](#) [BMVK160ADA4R7MD60G](#) [NACK222M10V12.5X14TR13F](#) [NRLF332M25V22X20F](#)
[NRSZ102M16V10X22TBF](#) [EEV-HA1H330UP](#) [MAL215097513E3](#) [UCZ1V681MNQ1MS](#) [EEE-FT1C122UP](#) [EEE-FT1C821UP](#)