



MDM connectors are used in applications requiring highly reliable, extremely small, lightweight connectors with higher density contact configurations than available in traditional rectangular connectors. They are available in 8 shell sizes accommodating from 9 to 100 contacts, and special arrangements of power and coaxial contacts.

These connectors are designed to meet the rapidly increasing demands for an environmental, high performance, rugged, moisture-sealed microminiature connector. This connector

employs size 24 MICROPIN™/MICROSOCKET™ contacts on .050 (1.27) centers in a contact density identical to the standard MICRO-D connector series, but with these additional features:

- Aluminum shells to provide greater strength, prevent chipping, cracking or breaking, offer electromagnetic (EMI) and RFI shielding.
- Silicone elastomer compression interfacial seal to provide a moisture and humidity seal between each contact and between contacts and shell.

## Specifications

STANDARD MATERIALS AND FINISHES		MECHANICAL FEATURES	
Shell	- 6061-T6 Aluminum alloy per QQ-A-200/8, yellow chromate/cadmium, Type II, Class 3 over electroless nickel per SAE AMS-C-26074, Class 4.	Coupling	- Friction/jackscrews
Insulator	- Liquid Crystal Polymer per MIL-M-24519, Type GLCP-30F (9-100) - Glass filled diallyl phthalate per MIL-M-14, Type SDGF (7*2 and 24*4) - Polyphenylene sulfide per MIL-M-24519, Type GST-40F (16*5) - Polyester per MIL-M-24519, Type GPT-30F (10*10)	Polarization	- Keystone-shaped shells
Contacts	- Copper alloy, gold plate	Contact Spacing Centers	- .050 (1.27)
Mounting Hardware Kit, Jackpost (3) items	- 300 Series stainless steel, passivate	Shell Styles	- Plug and receptacle
Washer	- 400 Series stainless steel, passivate	No. of Contacts	- 9 thru 100 signal; 5 signal/2 coaxial; 5 signal/2 power; 11 signal/5 coaxial; 11 signal/5 power; 0 signal/10 coaxial; 0 signal/10 power; 20 signal/4 coaxial; 20 signal/4 power
Standard Epoxy	- Hysol EE4215/HD3561, color black or Hysol EE4198/HD3561, color green	Coaxial Cable	- RG - 178/U
		Wire Size	- #24 thru #32 AWG
		Contact Termination	- Multiple indent crimp

## Performance Data

The table below summarizes the results of key tests performed in accordance with MIL-STD-1344, where applicable. Data is applicable to standard connectors with standard termination. Variations may affect this data, so please consult customer service for further information on your requirements.

Test	Method	Criteria of Acceptance
Dielectric Withstanding Voltage	Method 3001: 600 VAC at sea level 150 VAC at 70,00' altitude	No breakdown No breakdown
Insulation Resistance	Method 3003	5,000 megohms minimum
Thermal Shock	Method 1003, Condition A: - 55°C to +125°C	No physical damage
Physical Shock	Method 2004, Condition E: 50 G's, 3 axes, 6 millisecond duration sawtooth pulse	No physical damage No loss of continuity > 1 µsec
Vibration	Method 2005, Condition IV: 20 G's, 10-2,000 Hz. 12 hrs	No physical damage No loss of continuity > 1 µsec
Durability	500 cycles of mating and unmating, 500 CPH max.	No mechanical or electrical defects
Moisture Resistance	Method 1002, Type II, omit steps 7a & 7b	Insulation resistance > 100 megohms
Salt Spray	Method 1001, Condition B: 48 hours	Shall be capable of mating and unmating, and meet contact resistance requirements
Contact Resistance (MIL-STD-202)	Method 1001, Condition B: At 3 amps At 1 milliamp	8 milliohms maximum 10 milliohms maximum
Contact Retention	Per MIL-DTL-83513	5 lb. minimum axial load

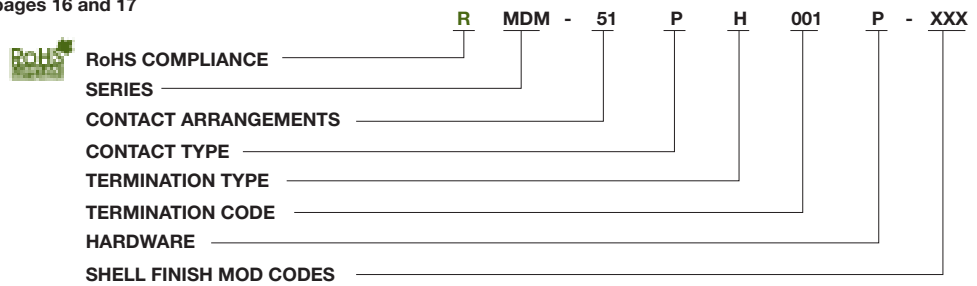
Dimensions shown in inch (mm)  
Specifications and dimensions subject to change

www.ittcannon.com



## How to Order

For MIL-DTL-83513 ordering information see pages 16 and 17



### SERIES

MDM: (Size 9-100) Liquid Crystal Polymer (LCP)  
MDM: (Combo Layout) Diallyl Phthalate (DAP)

### CONTACT ARRANGEMENTS

9-15-21-25-31-37-51-100 (standard)  
16C5, 10C10, 7C2, 24C4 (coaxial) } or combination of  
16P5, 10P10, 7P2, 24P4 (power) } coax and power

### CONTACT TYPE

P - Pin S - Socket

### TERMINATION TYPE

H - Harness-insulated wire.  
L - Solid-uninsulated wire.  
S - Solder pot to accept #26 AWG MAX.  
harness wire. (Not available with power  
contact arrangements.)

### HARDWARE

M - Military specification hardware, see  
page 11 for military hardware codes.  
P - Jackpost  
K - Jackscrew-standard profile  
L - Jackscrew-low profile  
F - Float mount  
B - No hardware standard  
.091 (2.31) dia. hole for sizes 9-51;  
.120 (3.05) dia. hole for size 100.  
A - .125 (3.18) dia. mounting holes for sizes 9-51;  
.166 (4.22) dia. hole for size 100.  
B1 - .1475 (3.75) dia. hole for size 100  
(Per MIL-DTL-83513)

### TERMINATION CODE\*

(H) 001 - 18", 7/34 strand, #26 AWG,  
MIL-W-16878/4, Type E Teflon, yellow.  
(H) 003 - 18", 7/34 strand, #26 AWG,  
MIL-W-16878/4, Type E Teflon,  
color coded to MIL-STD-681 System I.  
(L) 1 - 1/2" uninsulated solid #25  
AWG gold plated copper.  
(L) 2 - 1" uninsulated solid #25 AWG  
gold plated copper.

### SHELL FINISH MOD CODES

No Number - (Standard cadmium/yellow  
chromate over nickel  
A174 - Electroless nickel  
A172 - Gold over nickel  
A141 - Irridite/alodine  
A30 - Black anodize

\*See page 79 and 81 for additional Termination codes.



COTS or Non Mil-Spec or Commercial or Industrial Standard Wire Termination Codes

Cannon Modification Code (Not MS)

The following termination codes are listed for your information. For additional codes please refer to Appendix on page 79 and 81. **All wire lengths are minimum.**

### Harness Type (H)

#26 AWG per MIL-W-16878/4, 7/34 strand, type E Teflon, stranded.

Length	All Yellow	Color Coded*
3 (76.2)	H020	H027
6 (152.4)	H019	H016
8 (203.2)	H026	H034
10 (254.0)	H029	H025
12 (304.8)	H028	H002
18 (457.2)	H001	H003
20 (508.0)	H038	H023
24 (609.6)	H009	H004
30 (762.0)	H010	H005
36 (914.4)	H011	H006
48 (1219.2)	H013	H048
72 (1828.8)	H017	H046
120 (3048.0)	H042	H041

\* Cavity #1 black

### Solid Uninsulated Type (L)

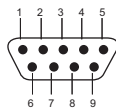
#25 AWG gold plated copper

Termination Code	Length
L61	.125 (3.18)
L56	.150 (3.81)
L57	.190 (4.83)
L39	.250 (6.35)
L58	.375 (9.52)
L1	.500 (12.70)
L14	.750 (19.05)
L2	1.000 (25.40)
L7	1.500 (38.10)
L6	2.000 (50.80)
L16	2.500 (63.50)
L10	3.000 (76.20)

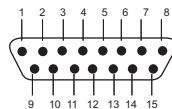
## Contact Arrangements

(Face View of Pin insert - Use Reverse Order for Socket Side)

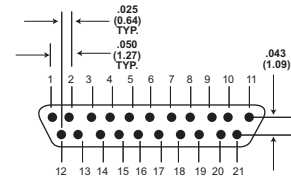
### Standard



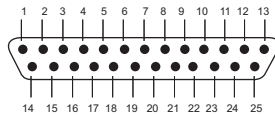
9 Contacts



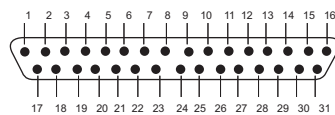
15 Contacts



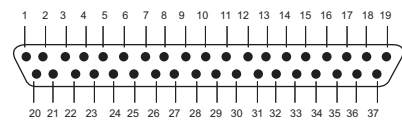
21 Contacts



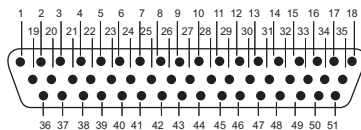
25 Contacts



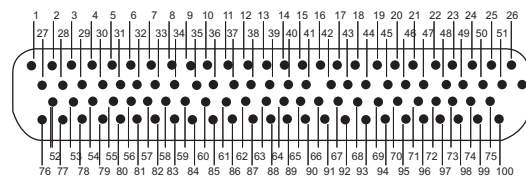
31 Contacts



37 Contacts

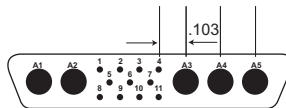


51 Contacts

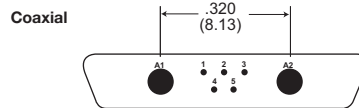


100 Contacts

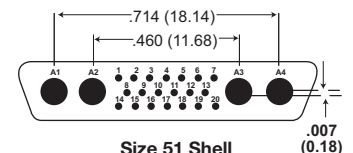
Contact identification numbers are for reference only and do not appear on insulator or connector body.



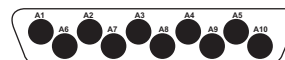
Size 51 Shell  
11 Micro contact  
5 Coax or 5 Power



Size 25 Shell  
5 Micro contact  
2 Coax or 2 Power



Size 51 Shell  
20 Micro contacts  
4 Coax or 4 Power  
(Not MS)



Size 100 Shell  
0 Micro contact  
10 Coax or 10 Power

Dimensions shown in inch (mm)

Specifications and dimensions subject to change

www.ittcannon.com

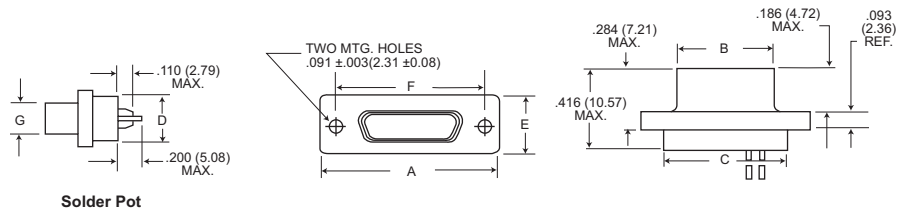


# Micro-D Metal Shell - .050" Contact Spacing

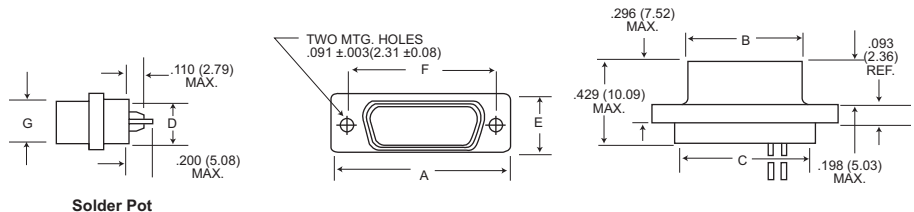
MDM

COTS or Non Mil-Spec or Commercial or Industrial Shell Dimensions (Conforms to MIL-DTL-83513)

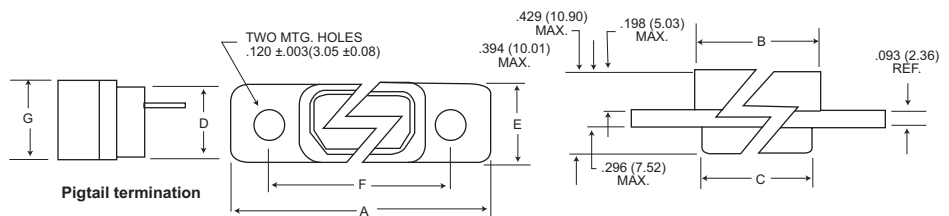
## Plug



## Receptacle



## Receptacle (MDM-100 only)

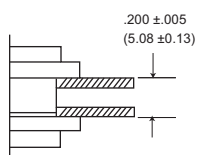


Part Number By Shell Size	A Max.	B Max.	C Max.	D Max.	E Max.	F + .005 (0.13)	G Max.	Average Weights** oz. (gm.) $\pm 5\%$
MDM-9P*	.785 (19.94)	.334 (8.48)	.400 (10.16)	.270 (6.86)	.308 (7.82)	.565 (14.35)	.185 (4.70)	.063 (1.79)
MDM-9S*	.785 (19.94)	.402 (10.21)	.400 (10.16)	.270 (6.86)	.308 (7.82)	.565 (14.35)	.253 (6.43)	.063 (1.79)
MDM-15P*	.935 (23.75)	.484 (12.29)	.550 (13.97)	.270 (6.86)	.308 (7.82)	.715 (18.16)	.185 (4.70)	.084 (2.39)
MDM-15S*	.935 (23.75)	.552 (13.97)	.550 (13.97)	.270 (6.86)	.308 (7.82)	.715 (18.16)	.253 (6.43)	.083 (2.37)
MDM-21P*	1.085 (27.56)	.634 (16.10)	.700 (17.78)	.270 (6.86)	.308 (7.82)	.865 (21.97)	.185 (4.70)	.105 (2.99)
MDM-21S*	1.085 (27.56)	.702 (17.83)	.700 (17.78)	.270 (6.86)	.308 (7.82)	.865 (21.97)	.253 (6.43)	.104 (2.97)
MDM-25P*	1.185 (30.10)	.734 (18.64)	.800 (20.32)	.270 (6.86)	.308 (7.82)	.965 (24.51)	.185 (4.70)	.119 (3.39)
MDM-25S*	1.185 (30.10)	.802 (20.37)	.800 (20.32)	.270 (6.86)	.308 (7.82)	.965 (24.51)	.253 (6.43)	.118 (3.36)
MDM-31P*	1.335 (33.91)	.884 (22.45)	.950 (24.13)	.270 (6.86)	.308 (7.82)	1.115 (28.32)	.185 (4.70)	.140 (3.99)
MDM-31S*	1.335 (33.91)	.952 (24.18)	.950 (24.13)	.270 (6.86)	.308 (7.82)	1.115 (28.32)	.253 (6.43)	.139 (3.96)
MDM-37P*	1.485 (37.72)	1.034 (26.26)	1.100 (27.94)	.270 (6.86)	.308 (7.82)	1.265 (32.13)	.185 (4.70)	.161 (4.59)
MDM-37S*	1.485 (37.72)	1.102 (27.99)	1.100 (27.94)	.270 (6.86)	.308 (7.82)	1.265 (32.13)	.253 (6.43)	.160 (4.56)
MDM-51P*	1.435 (36.45)	.984 (24.99)	1.050 (26.67)	.310 (7.87)	.351 (8.92)	1.215 (30.86)	.228 (5.79)	.193 (5.50)
MDM-51S*	1.435 (36.45)	1.052 (26.72)	1.050 (26.67)	.310 (7.87)	.351 (8.92)	1.215 (30.86)	.296 (7.52)	.188 (5.35)
MDM-100P*	2.170 (55.12)	1.384 (35.15)	1.442 (36.63)	.360 (9.14)	.394 (10.01)	1.800 (45.72)	.271 (6.88)	.500 (14.3)
MDM-100S*	2.170 (55.12)	1.508 (38.10)	1.442 (36.63)	.360 (9.14)	.394 (10.01)	1.800 (45.72)	.394 (10.01)	1.040 (29.5)

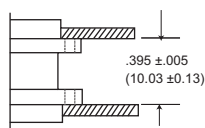
\*Add lead type and length; see How To Order.

\*\*\*Weight given is 1/2", insulated, solid, #25 AWG gold plated copper pigtails.

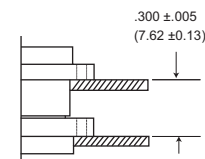
## Panel Mounting Dimensions (Sizes 9 - 100)



Plug and Receptacle  
Rear Mounted



Plug and Receptacle  
Front Mounted



Plug Front Mounted  
Receptacle Rear Mounted



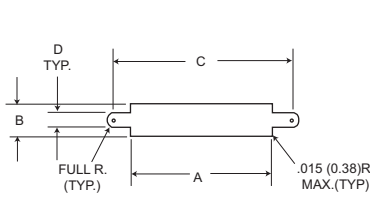
Dimensions shown in inch (mm)  
Specifications and dimensions subject to change

www.ittcannon.com

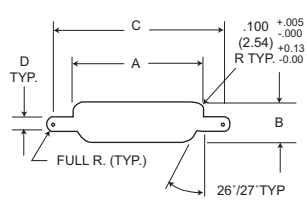
## Panel Cutouts

NOTE: See page 13 for rear panel mounting configuration.

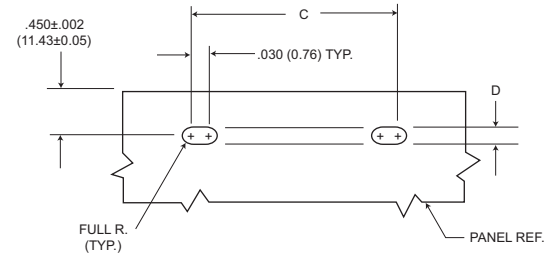
### Shell Sizes 9 thru 51



**Figure 1**  
Front Mounting

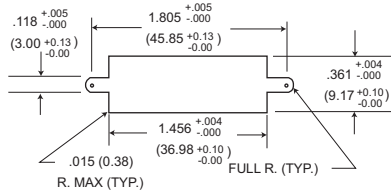


**Figure 2**  
Rear Mounting

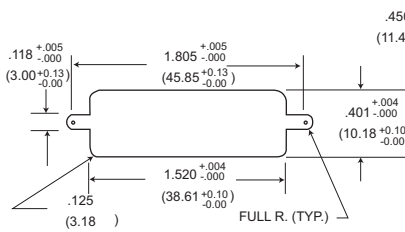


**Figure 3**  
Edgeboard Mounting

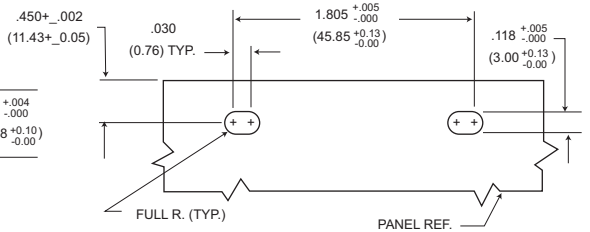
### Shell Size 100



**Figure 1**  
Front Mounting



**Figure 2**  
Rear Mounting



**Figure 3**  
Edgeboard Mounting

### For 9-51 Shell Sizes

#### NOTES:

1. Front panel mounting is the preferred mounting method. Front panel mounting dimensions (figure 1) will accommodate either #2-56 screws or jackpost hardware.
2. Rear panel mount dimensions (figure 2) will accommodate #2-56 screw hardware only. When mounting the connector with rear panel mount jackpost see the panel cut-out dimensions.
3. Edgeboard mounting bracket (figure 3) uses #2-56 screws. Dimension .450+/-0.002 (11.43+/-0.05) locates the MDM receptacle flush with the end of the board.

### For 100 Shell Size

#### NOTES:

1. Front mounting is the preferred mounting method. Front panel mounting dimensions (figure 1) will accommodate either #4-40 screws or jackpost hardware.
2. Rear panel mount dimensions (figure 2) will accommodate #4-40 screw hardware only see the panel cut-out dimensions.
3. Edgeboard mounting bracket (figure 3) uses #4-40 screws. Dimension .450+/-0.002 (11.43+/-0.05) locates the MDM receptacle flush with the end of the board.

Shell Size	Cutout Figure	A +.004 -.000	B +.004 -.000	C +.005 -.000	D +.005 -.000
9	1	.408	.271	.570	.089
	2	.401	.252	.570	.089
	3	-	-	.570	.089
15	1	.558	.271	.720	.089
	2	.551	.252	.720	.089
	3	-	-	.720	.089
21	1	.708	.271	.870	.089
	2	.701	.252	.870	.089
	3	-	-	.870	.089
25	1	.808	.271	.970	.089
	2	.801	.252	.970	.089
	3	-	-	.970	.089
31	1	.958	.271	1.120	.089
	2	.951	.252	1.120	.089
	3	-	-	1.120	.089
37	1	1.108	.271	1.270	.089
	2	1.101	.252	1.270	.089
	3	-	-	1.270	.089
51	1	1.058	.315	1.220	.089
	2	1.051	.295	1.220	.089
	3	-	-	1.220	.089

Dimensions shown in inch (mm)

Specifications and dimensions subject to change

www.ittcannon.com



## Mounting Hardware Views (for sizes 9-51)

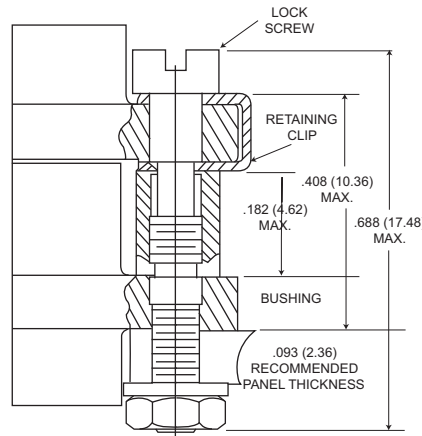
This hardware supplied unassembled.



**Screw Lock Assembly**

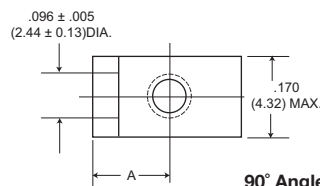


**90° Angle Mounting Bracket**

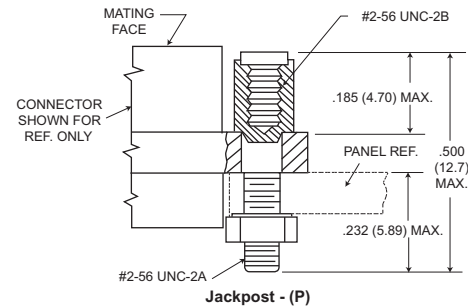


**Screw Lock Assembly\***

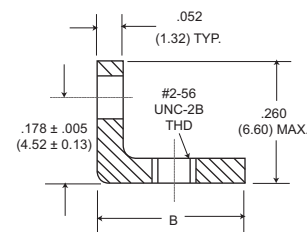
\*NOTE Torque value is 2.5 in/lbs max.



**90° Angle Mounting Bracket**



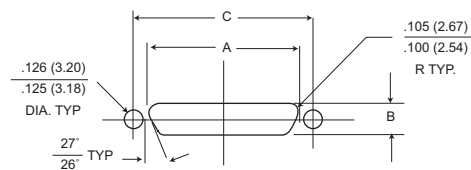
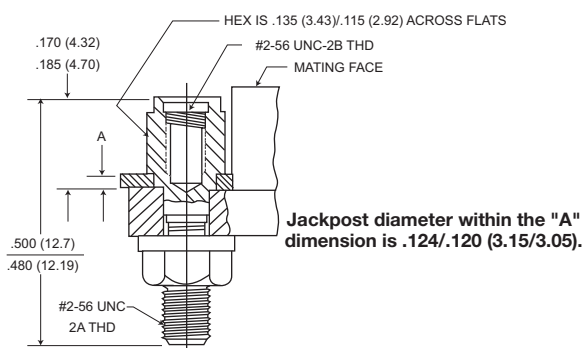
**Jackpost - (P)**



Description	Part Number	A	
		+/- .005 (±0.13)	B Max.
Screw Lock Assembly	322-9500-000		N/A
Jackpost kit	320-9505-000		N/A
Mounting Bracket 90° MDM for 9 thru 37 Shell Sizes	015-9516-002	.147 (3.73)	.308 (7.82)
Mounting Bracket 90° MDM for 51 Shell Size	015-9516-003	.169 (4.29)	.350 (8.89)

NOTES: Screw lock assembly (322-9500-000) can be used for front mounting only. Jackpost kit (320-9505-000) consists of two assemblies, shipped unassembled.

## Jackpost Bushing (for rear panel mounting-for sizes 9-51)



### Plug and Receptacle Dimensions

Shell Size	A		B		C
	+ .004 (0.10)	- .000 (0.00)	+ .004 (0.10)	- .000 (0.00)	
9	.401 (10.19)	.252 (6.40)	.565 (14.35)		
15	.551 (14.00)	.252 (6.40)	.715 (18.16)		
21	.701 (17.81)	.252 (6.40)	.865 (21.97)		
25	.801 (20.34)	.252 (6.40)	.965 (24.51)		
31	.951 (24.16)	.252 (6.40)	1.115 (28.34)		
37	1.101 (27.97)	.252 (6.40)	1.265 (32.13)		
51	1.051 (26.70)	.295 (7.49)	1.215 (30.86)		

Panel A Thickness	A		Jackpost Kit Number*
	+ .005 (0.13)	- .000 (0.00)	
3/32 (2.4)	.087 (2.21)		320-9505-007
1/16 (1.6)	.056 (1.42)		320-9505-006
3/64 (1.2)	.042 (1.07)		320-9505-005
1/32 (0.8)	.025 (0.64)		320-9505-004

\*A kit consists of 2 jackpost, 2 nuts, 2 washers.

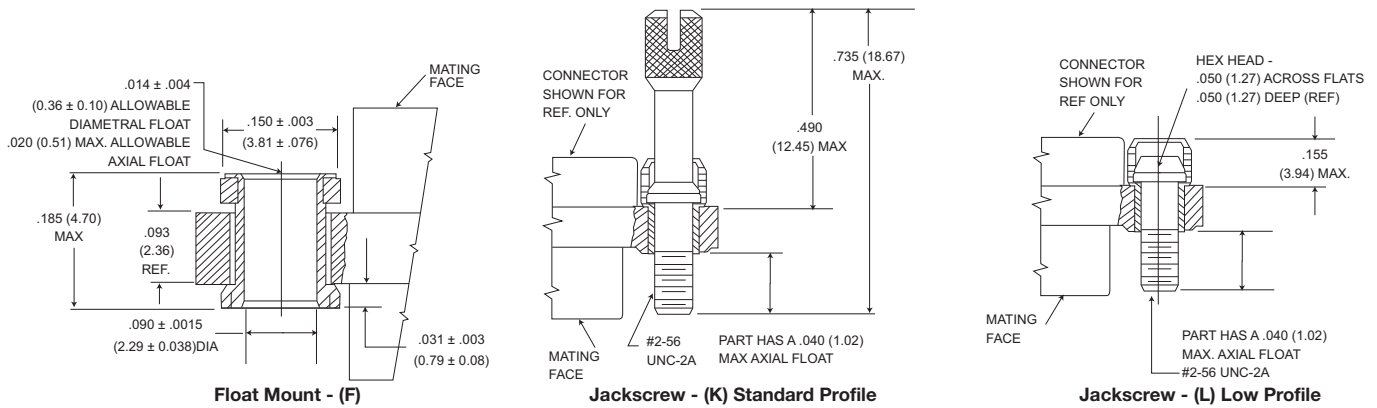


Dimensions shown in inch (mm)  
Specifications and dimensions subject to change

www.ittcannon.com

## Mounting Hardware Views (sizes 9-51)

This hardware is factory installed.

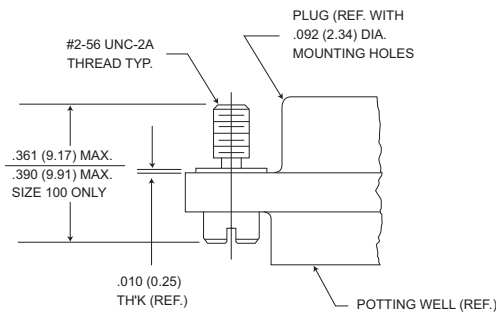


Shown here is a cutaway view of the float mount for the MDM connector. The basic shell dimensions are the same for the float mount and the screw mounting hole configurations. View shown is for standard float mount front panel mounting. Reverse mounting is available on request.

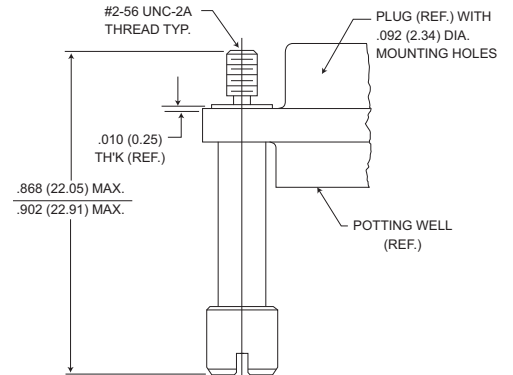
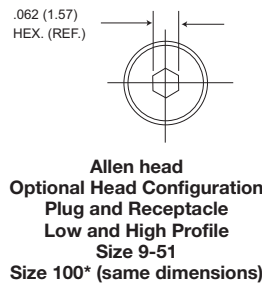
\* NOTE: Torque values are as follows:  
 Low Profile Jackscrew (L)-2.5 in-lbs  
 Standard Jackscrew (K)-2.5 in-lbs

## Mounting Hardware to Military Specification (for sizes 9 - 100) per MIL-DTL-83513/5

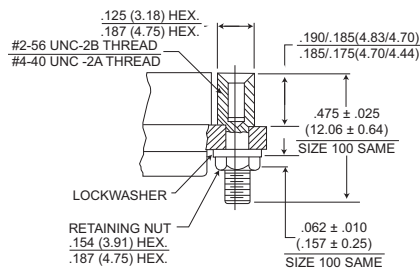
This hardware supplied in kits unassembled (2 pieces of each item).



**Figure 1. Jackscrew - Low profile Slotted Head Size 9-51 Size 100\***



**Figure 2. Jackscrew - High Profile Slotted Head Size 9-51 Size 100\***



**Figure 3. Jackpost Assembly Size 9-51 Size 100\***

To order hardware kits separately, order either by M83513/5-\*\* or by 320-950X-XXX.

Description	Size 9-51		Size 100*	
	Mod Code	Part Number	Mod Code	Part Number
Slotted Head Jackscrew Assy Low Profile (Figure 1)	M5	320-9508-025	05	M15 320-9508-021
Slotted Head Jackscrew Assy Low Profile (Figure 2)	M6	320-9508-027	06	M16 320-9508-023
Allen Head Jackscrew Assy Low Profile (Figure 1)	M2	320-9508-026	02	M12 320-9508-022
Allen Head Jackscrew Assy High Profile (Figure 2)	M3	320-9508-028	03	M13 320-9508-024
Jackpost Assy (Figure 3)	M7	320-9505-033	07	M17 320-9505-030

\*Size 100 requires B1 size mounting holes for Mil-Spec hardware

Note: Torque values as follows:

Size 9-51 4.0 in-lbs

Size 100 6.0 in-lbs

Dimensions shown in inch (mm)

Specifications and dimensions subject to change

www.ittcannon.com



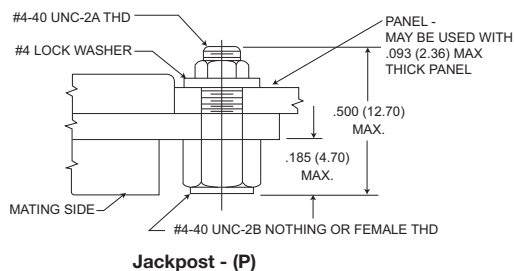
## Mounting Hardware Views (for size 100)

This hardware supplied unassembled.

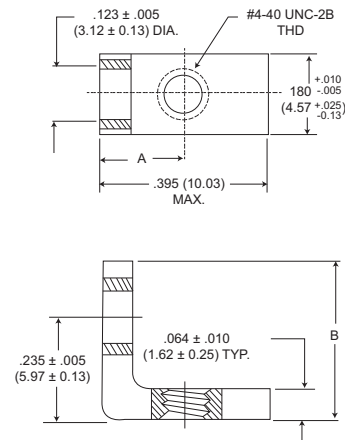


**90° Angle Mounting Bracket**

Note: Size 100 requires .120 dia (B) mounting hole when using Commercial (P) jackpost kits.



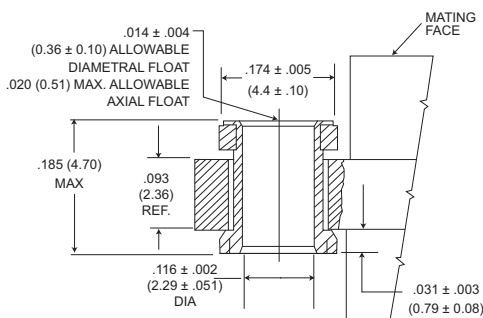
**Jackpost - (P)**



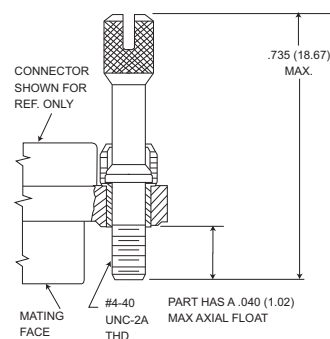
**90° Angle Mounting Bracket**

Description	Part Number	A ± .005 (0.13)	B Max.
Jackpost kit	320-9505-015	N/A	
Mounting Bracket 90° MDM	015-9528-000	.191 (4.85)	.370 (9.40)

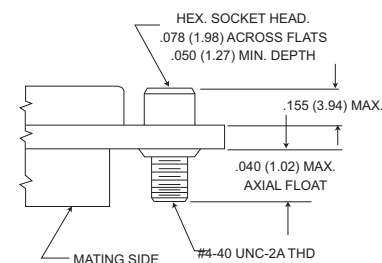
This hardware is factory installed.



**Float Mount - (F) Std.**



**Jackscrew - (K) Standard**



**Jackscrew - (L) (Low Profile)**

\*NOTE: Torque values are as follows:  
Low Profile Jackscrew (L)-4.0 in-lbs  
Standard Profile Jackscrew (K)-4.0 in-lbs

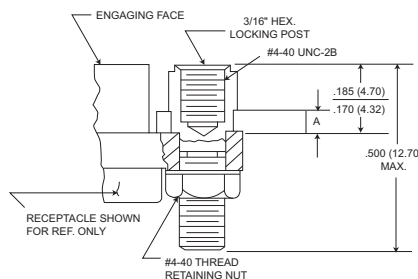
## Jackpost Bushing (for Rear Panel Mounting)

Panel Thickness	A + .005 (0.13) - .000 (0.00)	Jackpost Kit Number*
3/32 (2.4)	.087 (2.21)	320-9505-013
1/16 (1.6)	.058 (1.42)	320-9505-012
1/32 (0.8)	.025 (0.64)	320-9505-010
3/64 (1.2)	.042 (1.07)	320-9505-011

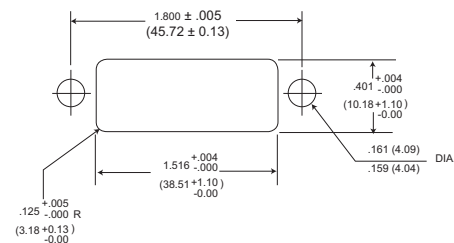
\*2 jackposts, 2 nuts, 2 washers

Torque value for size 100

Note: Size 100 requires B mounting hole shell size when using rear panel mount jackposts



### Dimensions for Rear Panel Mounting



Dimensions shown in inch (mm)  
Specifications and dimensions subject to change

www.ittcannon.com



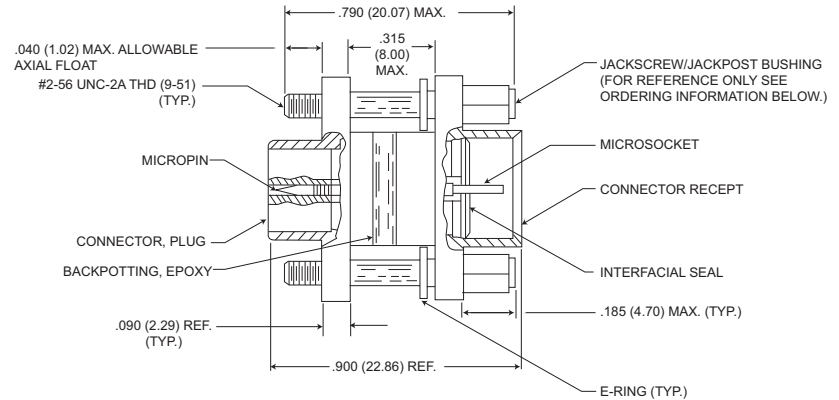
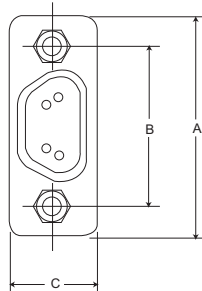
## Connector Saver



Save wear and tear on your equipment and systems connectors by using the "Connector Saver".

The multi-matings and unmatings experienced by most connectors during testing and final check out can be eliminated.

Simply mate the "Connectors Saver" to your unit and use the opposite side for your testing interface...less wear, less tear, less chance of damage. It is available in all eight standard MDM layouts. Mating hardware is available and can be ordered either separately or included with the connector saver.



MDM Size 9 Shown

Size	Electroless Nickel (A174) Plated		Cadmium over Nickel (A101) Plated		*Hardware Kits	A Max.	B ± .005 (0.13)	C Max.
	With Hardware	W/O Hardware	With Hardware	W/O Hardware				
9	MDM98479-86	MDM98479-18	MDM98479-78	MDM-97294-371	320-9505-014**	.785 (19.94)	.565 (14.35)	.308 (7.82)
15	MDM98479-87	MDM98479-19	MDM98479-79	MDM-97294-372	320-9505-014**	.935 (23.75)	.715 (18.16)	.308 (7.82)
21	MDM98479-88	MDM98479-20	MDM98479-80	MDM-97294-373	320-9505-014**	1.085 (27.56)	.865 (21.97)	.308 (7.82)
25	MDM98479-89	MDM98479-21	MDM98479-81	MDM-97294-374	320-9505-014**	1.185 (30.10)	.965 (24.51)	.308 (7.82)
31	MDM98479-90	MDM98479-14	MDM98479-82	MDM-97294-375	320-9505-014**	1.335 (33.91)	1.115 (28.32)	.308 (7.82)
37	MDM98479-91	MDM98479-15	MDM98479-83	MDM-97294-376	320-9505-014**	1.485 (37.72)	1.265 (32.13)	.308 (7.82)
51	MDM98479-92	MDM98479-16	MDM98479-84	MDM-97294-377	320-9505-014**	1.435 (36.45)	1.215 (30.86)	.351 (8.91)
100	MDM98479-93	MDM98479-17	MDM98479-85	MDM-97294-717	320-9508-014***	2.170 (55.12)	1.800 (45.72)	.394 (10.01)

\* Kit contains 2 jackpost/jackscrew bushings and 2 E-Rings.  
 \*\* Size 9-51-#2-56 UNC-2B Thread  
 \*\*\* Size 100-#4-40 UNC-2B Thread

M83513/ 01 - H100 - \*\* \*\*\*\*

**SERIES**

- MDM - Metal Shell, Liquid Crystal Polymer (LCP)
- MDB - Diallyl Phthalate Insulator
- MDVB - Polyester Insulator
- 

**MIL-C-83513 SLASH SHEET**

- 01 - Plug, Connector, Solderpot
  - 02 - Receptacle, Connector, Solderpot
  - 03 - Plug, Connector, Crimp Type
  - 04 - Receptacle, Connector, Crimp Type
  - 05 - Hardware Only <sup>△</sup>
  - 06 - Plug, Connector, Solderpot
  - 07 - Receptacle, Connector, Solderpot
  - 08 - Plug, Connector, Crimp Type
  - 09 - Receptacle, Connector, Crimp Type
- } Metal Shell
- } Plastic <sup>△</sup>

**INSERT ARRANGEMENT**

	<u>METAL SHELL</u>	<u>PLASTIC</u>
A -	9 Contact	9 Contact
B -	15 Contact	15 Contact
C -	21 Contact	21 Contact
D -	25 Contact	25 Contact
E -	31 Contact	31 Contact
F -	37 Contact	37 Contact
G -	51 Contact	51 Contact
H -	100 Contact	<sup>△</sup>

**WIRE TYPE**

- No Number - For Solderpot
- 01 - 18" long, #26 AWG per MIL-W-22759/11-26-9 (all white)
- 02 - 36" long, #26 AWG per MIL-W-22759/11-26-9 (all white)
- 03 - 18" long, #26 AWG per MIL-W-22759/11-26-9  
Color Coded per MIL-STD-681, System 1, 10 colors repeating <sup>△</sup>
- 04 - 36" long, #26 AWG per MIL-W-22759/11-26-9  
Color Coded per MIL-STD-681, System 1, 10 colors repeating <sup>△</sup>
- 05 - .5" long, #25 AWG, type S per QQ-W-343, Gold Plated
- 06 - 1.0" long, #25 AWG, type S per QQ-W-343, Gold Plated
- 07 - .5" long, #25 AWG, type S per QQ-W-343, Tin Plated
- 08 - 1.0" long, #25 AWG, type S per QQ-W-343, Tin Plated
- 09 - 18" long, #26 AWG per MIL-W-22759/33-26-9 (all white) <sup>△</sup>
- 10 - 36" long, #26 AWG per MIL-W-22759/33-26-9 (all white) <sup>△</sup>
- 11 - 18" long, #26 AWG per MIL-W-22759/33-26-9  
Color Coded per MIL-STD-681, System 1, 10 colors repeating <sup>△</sup> <sup>△</sup>
- 12 - 36" long, #26 AWG per MIL-W-22759/33-26-9  
Color Coded per MIL-STD-681, System 1, 10 colors repeating <sup>△</sup> <sup>△</sup>
- 13 - 72" long, #26 AWG per MIL-W-22759/11-26-9 (all white)
- 14 - 72" long, #26 AWG per MIL-W-22759/11-26-9  
Color Coded per MIL-STD-681, System 1, 10 colors repeating <sup>△</sup>
- 15 - 72" long, #26 AWG per MIL-W-22759/33-26-9 (all white) <sup>△</sup>
- 16 - 72" long, #26 AWG per MIL-W-22759/33-26-9  
Color Coded per MIL-STD-681, System 1, 10 colors repeating <sup>△</sup> <sup>△</sup>

**NOTES:**

- <sup>1</sup> - For every Mil Spec Part Number, ITT has one corresponding part number shown an example
- <sup>△</sup> - Tolerance on wire lengths: 18", 36" and 72" long – +1.00"/-0.00" .5" and 1.00" – +.200"/-.000"
- <sup>△</sup> - For space application, connector shell finish must be "A174" and wire must be per MIL-W-22759/33-26.
- 4 - Any deviations to these P/N's will result in assignment of a special P/N, consult factory.
- <sup>△</sup> - Size 100 not available in / 06 through / 09. (Plastic shell)
- <sup>△</sup> - Color coding in accordance with MIL-STD-681, System 1, no parenthesis. See page 83 for color code chart.
- <sup>△</sup> - For mounting hardware to Military Specification (sizes 9 to 100) see page 13.

**SHELL FINISH**

- No number - for plastic type connector
- C – for Cadmium/Yellow chromate over nickel
- N – A174 - Electroless Nickel A174 <sup>△</sup>



M83513/ 10 - A \*\* C \*

### SERIES

Connector, Electrical, Rectangular  
 Microminiature, Polarized Shell  
 PC Board Mounting

### MIL-C-83513 SLASH SHEET

- 10 - Connector, Plug, Condensed Board Right Angle (CBR), Sizes 9 – 37
- 11 - Connector, Plug, CBR, Size 51
- 12 - Connector, Plug, CBR, Size 100
- 13 - Connector, Receptacle, CBR, Sizes 9 – 37
- 14 - Connector, Receptacle, CBR Size 51
- 15 - Connector, Receptacle, CBR, Size 100
- 16 - Connector, Plug, Board Right Angle (BR), Sizes 9 – 37
- 17 - Connector, Plug, BR, Size 51
- 18 - Connector, Plug, BR, Size 100
- 19 - Connector, Receptacle, BR, Sizes 9 – 37
- 20 - Connector, Receptacle, BR Size 51
- 21 - Connector, Receptacle, BR Size 100
- 22 - Connector, Plug, Board Straight (BS), Sizes 9 – 37
- 23 - Connector, Plug, BS, Size 51
- 24 - Connector, Plug, BS, Size 100
- 25 - Connector, Receptacle, BS, Sizes 9 – 37
- 26 - Connector, Receptacle, BS, Size 51
- 27 - Connector, Receptacle, BS Size 100

### INSERT ARRANGEMENT

#### METAL SHELL

- A - 9 Contact
- B - 15 Contact
- C - 21 Contact
- D - 25 Contact
- E - 31 Contact
- F - 37 Contact
- G - 51 Contact
- H - 100 Contact

### WIRE TYPE

- No Number - For Solderpot
- 01 - .109" long, #24 AWG solid copper wire per QQ-W-343, Type "S", solder dipped
- 02 - .140" long, #24 AWG solid copper wire per QQ-W-343, Type "S", solder dipped  $\triangle$
- 03 - .172" long, #24 AWG solid copper wire per QQ-W-343, Type "S", solder dipped

### NOTES:

- 1 - For every Mil Spec Part Number, ITT has one corresponding part number
- $\triangle$  - Tolerance on wire lengths  $\pm$ .015
- $\triangle$  - For space application, connector shell finish must be "N".
- 4 - Any deviations to these P/N's will result in assignment of a special P/N, consult customer service.

### SHELL FINISH

- No letter - for plastic type connector
- C - Cadmium / Yellow chromate over nickel
- N - Electroless Nickel  $\triangle$   $\triangle$

### HARDWARE

- N - No jackpost
- P - Jackpost (permanently attached)
- T - Threaded insert

## X-ON Electronics

Largest Supplier of Electrical and Electronic Components

*Click to view similar products for [D-Sub Standard Connectors](#) category:*

*Click to view products by [ITT](#) manufacturer:*

Other Similar products are found below :

[DCM37S732N](#) [DAM15P500](#) [DEV09S364GTLF](#) [DEM09P032N](#) [DDM50P732N](#) [DAM15S332N](#) [173109-2218](#) [173109-2466](#) [173109-2436](#)  
[173109-2435](#) [56F706-005-LI](#) [56F711-015](#) [015-0341-000](#) [015-0372-008](#) [015-8544-011](#) [017041-0005](#) [020419-0104](#) [012-0515-000](#) [012-9507-](#)  
[034](#) [012-9507-114](#) [012-9534-001](#) [020745-0008](#) [609-25P](#) [M24308/2-23Z](#) [M243082310F](#) [M243082410F](#) [M243082411F](#) [M24308/4-21](#)  
[CT1A18-11PSA206](#) [CT1N36-5SC](#) [CT2-16S-17PS](#) [CT2-20-15PCAU](#) [CT2-24-12PS](#) [CT2-24-28PSF127A206](#) [CT2-32-9PC](#) [CT6F9767-14-4-](#)  
[14S-5PC](#) [CT6FA10SL-4PS](#) [CT7-18-10SC](#) [CT7-18-10SCAU](#) [CT7-18-12SCAU](#) [CT7-18-1PC](#) [CT7-18-1PCAU](#) [CT7-18-21SCAU](#) [M83513/01-](#)  
[FC](#) [M83723/76W24619 L/C](#) [M85049/48-3-2F](#) [69001-865](#) [6STD09PCM99B70X](#) [6STD09SCM99B30X](#) [6STD09SCT99S40X](#)