

Cree® Screen Master® 4-mm Oval LED C4SMB-RGF/GGF/BGF



PRODUCT DESCRIPTION

These oval LEDs are specifically designed for full-color video screens, digital billboards and passenger-information signs. The oval-shaped radiation pattern and high luminous intensity ensure that these devices are excellent for bright sunlight or low power consumption outdoor applications.

These lamps are made with an advanced optical-grade epoxy that offers superior high-temperature and high-moisture-resistance performance in outdoor signal and sign applications. The encapsulation resin contains anti-UV material in order to reduce the effects of long-term exposure to direct sunlight.

FEATURES

- Size (mm): 4
- Color and Typical Dominant Wavelength:
Red (621nm)
Green(524nm)
Blue(470nm)
- Luminous Intensity (mcd)
C4SMB-RGF: (1976-4600)
C4SMB-GGF: (5020-12000)
C4SMB-BGF: (934-2130)
- Lead - Free
- RoHS Compliant

APPLICATIONS

- Electronic Signs & Signals (ESS)
- Full Color Video Screen
- Digital Billboards
- Motorway Signs
- Variable Message Sign (VMS)
- Advertising Signs
- Petrol Signs

ABSOLUTE MAXIMUM RATINGS ($T_A = 25^\circ\text{C}$)

Items	Symbol	Absolute Maximum Rating		Unit
		Red	Blue and Green	
Forward Current	I_F	50 ^{Note1}	35	mA
Peak Forward Current ^{Note2}	I_{FP}	200	100	mA
Reverse Voltage	V_R	5	5	V
Power Dissipation	P_D	130	140	mW
Operation Temperature	T_{opr}	-40 ~ +95		$^\circ\text{C}$
Storage Temperature	T_{stg}	-40 ~ +100		$^\circ\text{C}$
Lead Soldering Temperature	T_{sol}	Max. 260 $^\circ\text{C}$ for 3 sec. max. (3 mm from the base of the epoxy bulb)		
Electrostatic Discharge Classification (MIL-STD-883E)	ESD	Class 2		

Note:

1. For long term performance the drive currents between 10mA and 30mA are recommended. Please contact CREE sales representative for more information on recommended drive conditions.
2. Pulse width ≤ 0.1 msec, duty $\leq 1/10$.

TYPICAL ELECTRICAL & OPTICAL CHARACTERISTICS ($T_A = 25^\circ\text{C}$)

Characteristics	Color	Symbol	Condition	Unit	Minimum	Typical	Maximum
Forward Voltage	Red	V_F	$I_F = 20$ mA	V		2.0	2.6
	Green	V_F	$I_F = 20$ mA	V		3.0	3.8
	Blue	V_F	$I_F = 20$ mA	V		3.2	3.8
Reverse Current	Red	I_R	$V_R = 5$ V	μA			100
	Blue/Green	I_R	$V_R = 5$ V	μA			100
Dominant Wavelength	Red	λ_D	$I_F = 20$ mA	nm	619	621	624
	Green	λ_D	$I_F = 20$ mA	nm	520	524	535
	Blue	λ_D	$I_F = 20$ mA	nm	460	470	475
Luminous Intensity	Red	I_V	$I_F = 20$ mA	mcd	1976	2800	
	Green	I_V	$I_F = 20$ mA	mcd	5020	7500	
	Blue	I_V	$I_F = 20$ mA	mcd	934	1400	

INTENSITY BIN LIMIT ($I_F = 20 \text{ mA}$)

Red: C4SMB-RGF

Bin Code	Min.(mcd)	Max.(mcd)
U4	1976	2130
V1	2130	2347
V2	2347	2564
V3	2564	2781
V4	2781	3000
W1	3000	3295
W2	3295	3590
W3	3590	3885
W4	3885	4180
X1	4180	4600

Green: C4SMB-GGF

Bin Code	Min.(mcd)	Max.(mcd)
X3	5020	5440
X4	5440	5860
Y1	5860	6445
Y2	6445	7030
Y3	7030	7615
Y4	7615	8200
Z1	8200	9150
Z2	9150	10100
Z3	10100	11050
Z4	11050	12000

Blue: C4SMB-BGF

Bin Code	Min.(mcd)	Max.(mcd)
S3	934	1017
S4	1017	1100
T1	1100	1205
T2	1205	1310
T3	1310	1415
T4	1415	1520
U1	1520	1672
U2	1672	1824
U3	1824	1976
U4	1976	2130

- Tolerance of measurement of luminous intensity is $\pm 15\%$

COLOR BIN LIMIT ($I_F = 20 \text{ mA}$)

Red

Bin Code	Min.(nm)	Max.(nm)
RB	619	624

Green

Bin Code	Min.(nm)	Max.(nm)
G7	520	525
G23	522.5	527.5
G8	525	530
G45	527.5	532.5
G9	530	535

Blue

Bin Code	Min.(nm)	Max.(nm)
B3	460	465
B23	462.5	467.5
B4	465	470
B45	467.5	472.5
B5	470	475

- Tolerance of measurement of dominant wavelength is $\pm 1 \text{ nm}$

ORDER CODE TABLE*

C4SMB-RGF

Color	Kit Number	Luminous Intensity (mcd)		Dominant Wavelength				Pack- age
		Min.	Max.	Color Bin	Min. (nm)	Color Bin	Max. (nm)	
Red	C4SMB-RGF-CU4X1BB1	1976	4600	RB	619	RB	624	Bulk
Red	C4SMB-RGF-CV14QBB1	Any 4 consecutive sub-bins: V1(2130) - W2(3590)		RB	619	RB	624	Bulk
Red	C4SMB-RGF-CV24QBB1	Any 4 consecutive sub-bins: V2(2347) - W3(3885)		RB	619	RB	624	Bulk
Red	C4SMB-RGF-CU4X1BB2	1976	4600	RB	619	RB	624	Ammo
Red	C4SMB-RGF-CV14QBB2	Any 4 consecutive sub-bins: V1(2130) - W2(3590)		RB	619	RB	624	Ammo
Red	C4SMB-RGF-CV24QBB2	Any 4 consecutive sub-bins: V2(2347) - W3(3885)		RB	619	RB	624	Ammo

C4SMB-GGF

Color	Kit Number	Luminous Intensity (mcd)		Dominant Wavelength				Pack- age
		Min.	Max.	Color Bin	Min. (nm)	Color Bin	Max. (nm)	
Green	C4SMB-GGF-CX3Z4791	5020	12000	G7	520	G9	535	Bulk
Green	C4SMB-GGF-CX44Q7C1	Any 4 consecutive sub-bins: X4(5440) - Z1(9150)		Any 1 color bin from G7 (520) to G9 (535)				Bulk
Green	C4SMB-GGF-CX44Q7S1	Any 4 consecutive sub-bins: X4(5440) - Z1(9150)		Any 1 color bin from G7 (520) to G8 (530)				Bulk
Green	C4SMB-GGF-CX44Q8S1	Any 4 consecutive sub-bins: X4(5440) - Z1(9150)		Any 1 color bin from G8 (525) to G9 (535)				Bulk
Green	C4SMB-GGF-CY14Q7C1	Any 4 consecutive sub-bins: Y1(5860) - Z2(10100)		Any 1 color bin from G7 (520) to G9 (535)				Bulk
Green	C4SMB-GGF-CY14Q7S1	Any 4 consecutive sub-bins: Y1(5860) - Z2(10100)		Any 1 color bin from G7 (520) to G8 (530)				Bulk
Green	C4SMB-GGF-CY14Q8S1	Any 4 consecutive sub-bins: Y1(5860) - Z2(10100)		Any 1 color bin from G8 (525) to G9 (535)				Bulk
Green	C4SMB-GGF-CX3Z4792	5020	12000	G7	520	G9	535	Ammo
Green	C4SMB-GGF-CX44Q7C2	Any 4 consecutive sub-bins: X4(5440) - Z1(9150)		Any 1 color bin from G7 (520) to G9 (535)				Ammo
Green	C4SMB-GGF-CX44Q7S2	Any 4 consecutive sub-bins: X4(5440) - Z1(9150)		Any 1 color bin from G7 (520) to G8 (530)				Ammo
Green	C4SMB-GGF-CX44Q8S2	Any 4 consecutive sub-bins: X4(5440) - Z1(9150)		Any 1 color bin from G8 (525) to G9 (535)				Ammo
Green	C4SMB-GGF-CY14Q7C2	Any 4 consecutive sub-bins: Y1(5860) - Z2(10100)		Any 1 color bin from G7 (520) to G9 (535)				Ammo
Green	C4SMB-GGF-CY14Q7S2	Any 4 consecutive sub-bins: Y1(5860) - Z2(10100)		Any 1 color bin from G7 (520) to G8 (530)				Ammo
Green	C4SMB-GGF-CY14Q8S2	Any 4 consecutive sub-bins: Y1(5860) - Z2(10100)		Any 1 color bin from G8 (525) to G9 (535)				Ammo

ORDER CODE TABLE*

Color	Kit Number	Luminous Intensity (mcd)		Dominant Wavelength				Pack- age
		Min.	Max.	Color Bin	Min. (nm)	Color Bin	Max. (nm)	
Blue	C4SMB-BGF-CS3U4351	934	2130	B3	460	B5	475	Bulk
Blue	C4SMB-BGF-CS44Q3C1	Any 4 consecutive sub-bins: S4(1017) - U1(1672)		Any 1 color bin from B3 (460) to B5 (475)				Bulk
Blue	C4SMB-BGF-CS44Q3S1	Any 4 consecutive sub-bins: S4(1017) - U1(1672)		Any 1 color bin from B3 (460) to B4 (470)				Bulk
Blue	C4SMB-BGF-CS44Q4S1	Any 4 consecutive sub-bins: S4(1017) - U1(1672)		Any 1 color bin from B4 (465) to B5 (475)				Bulk
Blue	C4SMB-BGF-CT24Q3C1	Any 4 consecutive sub-bins: T2(1205) - U3(1976)		Any 1 color bin from B3 (460) to B5 (475)				Bulk
Blue	C4SMB-BGF-CT24Q3S1	Any 4 consecutive sub-bins: T2(1205) - U3(1976)		Any 1 color bin from B3 (460) to B4 (470)				Bulk
Blue	C4SMB-BGF-CT24Q4S1	Any 4 consecutive sub-bins: T2(1205) - U3(1976)		Any 1 color bin from B4 (465) to B5 (475)				Bulk
Blue	C4SMB-BGF-CS3U4352	934	2130	B3	460	B5	475	Ammo
Blue	C4SMB-BGF-CS44Q3C2	Any 4 consecutive sub-bins: S4(1017) - U1(1672)		Any 1 color bin from B3 (460) to B5 (475)				Ammo
Blue	C4SMB-BGF-CS44Q3S2	Any 4 consecutive sub-bins: S4(1017) - U1(1672)		Any 1 color bin from B3 (460) to B4 (470)				Ammo
Blue	C4SMB-BGF-CS44Q4S2	Any 4 consecutive sub-bins: S4(1017) - U1(1672)		Any 1 color bin from B4 (465) to B5 (475)				Ammo
Blue	C4SMB-BGF-CT24Q3C2	Any 4 consecutive sub-bins: T2(1205) - U3(1976)		Any 1 color bin from B3 (460) to B5 (475)				Ammo
Blue	C4SMB-BGF-CT24Q3S2	Any 4 consecutive sub-bins: T2(1205) - U3(1976)		Any 1 color bin from B3 (460) to B4 (470)				Ammo
Blue	C4SMB-BGF-CT24Q4S2	Any 4 consecutive sub-bins: T2(1205) - U3(1976)		Any 1 color bin from B4 (465) to B5 (475)				Ammo

Notes:

1. The above kit numbers represent order codes that include multiple intensity-bin and color-bin codes. Only one intensity-sub-bin code and one color-bin code will be shipped on each reel. Selected single intensity-bin, single color-bin codes will be orderable in certain quantities. For example, any four consecutive sub-bins from V1 to W2 mean only one intensity bin with four sub-bins of the following brightness ranges (X3-Y2, X4-Y3, Y1-Y4) will be shipped by Cree. For example, any one-color bin from G7 to G9 means only one color bin (G7 or G23 or G8 or G45 or G9) will be shipped by Cree.
2. Please refer to the "Cree LED Lamp Reliability Test Standards" document #1 for reliability test conditions.
3. Please refer to the "Cree LED Lamp Soldering & Handling" document #2 for information about how to use this LED product safely.

#1: Refer to http://www.cree.com/led-components/media/documents/LED_Lamp_Reliability_Test_Standard.pdf

#2: Refer to <http://www.cree.com/led-components/media/documents/sh-HB.pdf>

GRAPHS

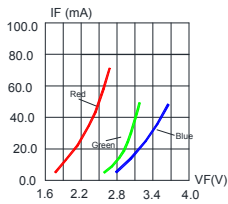

FIG.1 FORWARD CURRENT VS. FORWARD VOLTAGE.

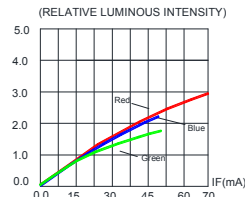

FIG.2 RELATIVE LUMINOUS INTENSITY VS. FORWARD CURRENT

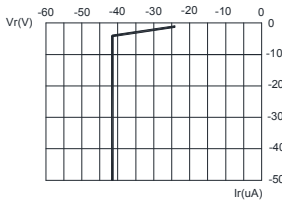

FIG.3a RED REVERSE CURRENT VS. REVERSE VOLTAGE.

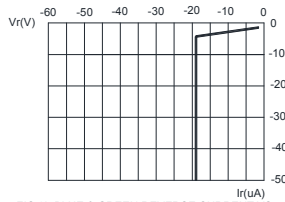

FIG.3b BLUE & GREEN REVERSE CURRENT VS. REVERSE VOLTAGE.

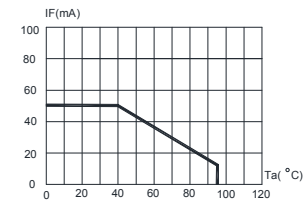

FIG.4a RED MAXIMUM FORWARD DC CURRENT VS AMBIENT TEMPERATURE (Tjmax=105°C)

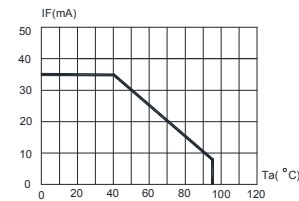

FIG.4b BLUE & GREEN MAXIMUM FORWARD DC CURRENT VS AMBIENT TEMPERATURE (Tjmax=105°C)

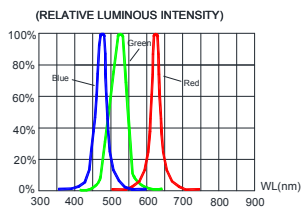

FIG.5 RELATIVE LUMINOUS INTENSITY VS. WAVELENGTH.

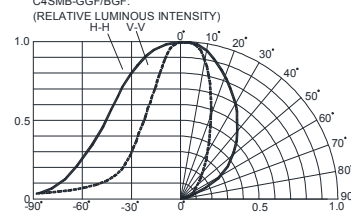

FIG.6a BLUE&GREEN FAR FIELD PATTERN

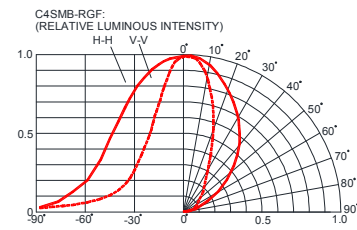

FIG.6b RED FAR FIELD PATTERN

The above data are collected from statistical figures that do not necessarily correspond to the actual parameters of each single LED. Hence, these data will be changed without further notice.

MECHANICAL DIMENSIONS

All dimensions are in mm. Tolerance is ± 0.25 mm unless otherwise noted.

An epoxy meniscus may extend about 1.5 mm down the leads.

Burr around bottom of epoxy may be 0.5 mm max.

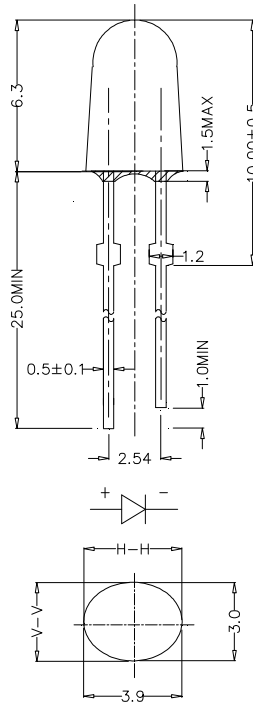

NOTES

Lead Frame Materials

Ag-plated and Lead-free Solder-plated iron.

RoHS Compliance

The levels of environmentally sensitive, persistent biologically toxic (PBT), persistent organic pollutants (POP), or otherwise restricted materials in this product are below the maximum concentration values (also referred to as the threshold limits) permitted for such substances, or are used in an exempted application, in accordance with EU Directive 2002/95/EC on the restriction of the use of certain hazardous substances in electrical and electronic equipment (RoHS), as amended through April 21, 2006.

Vision Advisory Claim

Users should be cautioned not to stare at the light of this LED product. The bright light can damage the eye.

KIT NUMBER SYSTEM

All dimensions in mm. Cree LED lamps are tested and sorted into performance bins. A bin is specified by ranges of color, forward voltage, and brightness. Sorted LEDs are packaged for shipping in various convenient options. Please refer to the "Cree LED Lamp Packaging Standard" document for more information about shipping and packaging options.

Cree LEDs are sold by order codes in combinations of bins called kits. Order codes are configured in the following manner:

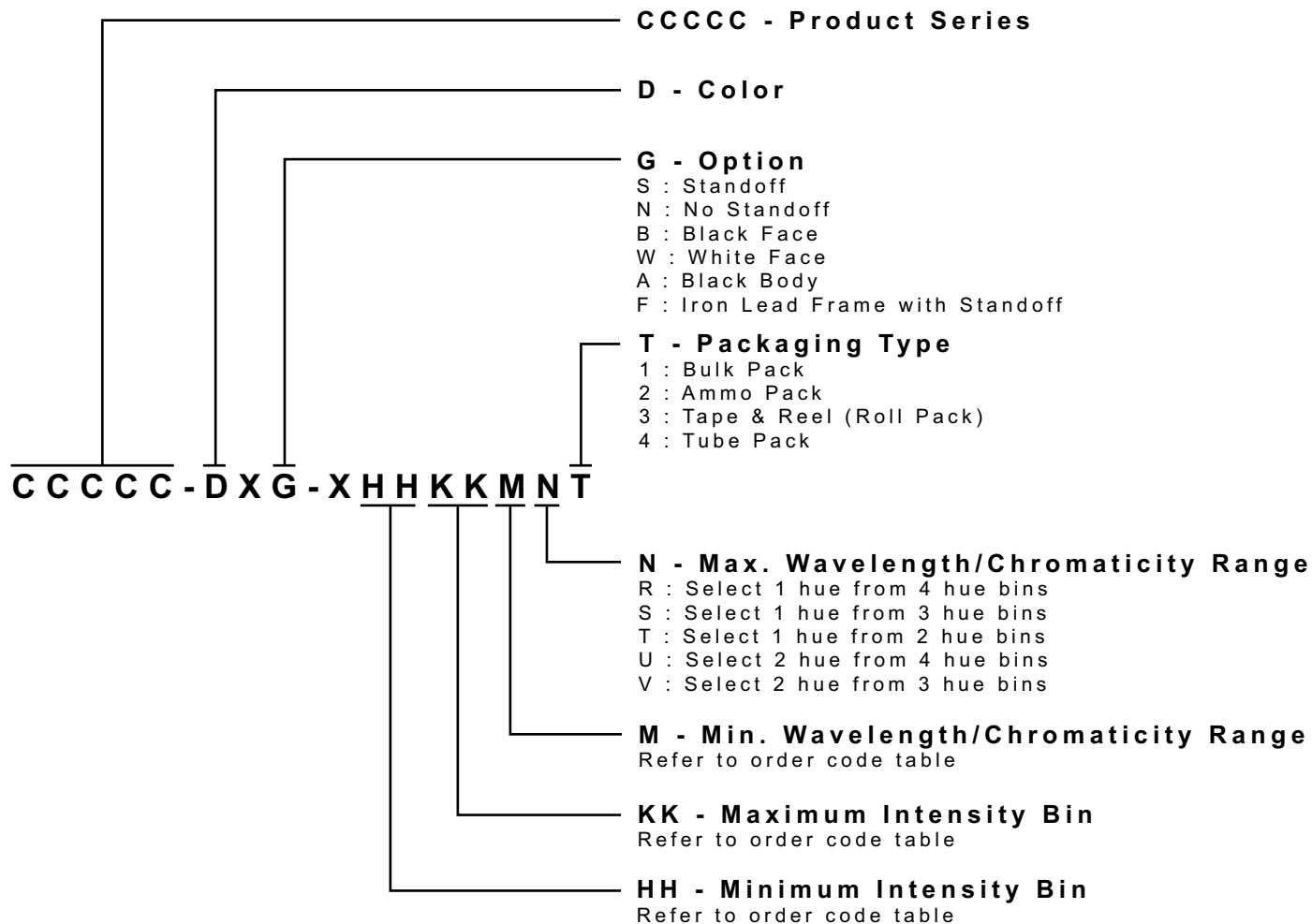

* Please contact our sales representative for ordering information.

REFLOW SOLDERING

The LED soldering specification is shown below (suitable for both leaded solder & lead-free solder):

Manual Soldering		Solder Dipping	
Soldering iron	35 W max	Preheat	110 °C max
Temperature	300 °C max	Preheat time	60 seconds max
		Solder-bath temperature	260 °C Max
Soldering time	3 seconds max	Dipping time	5 seconds max
Position	Not less than 3 mm from the base of the package.	Position	Not less than 3 mm from the base of the package.

- Manual soldering onto the PCB is not recommended because soldering time is uncontrollable.
- The recommended wave soldering is as below:

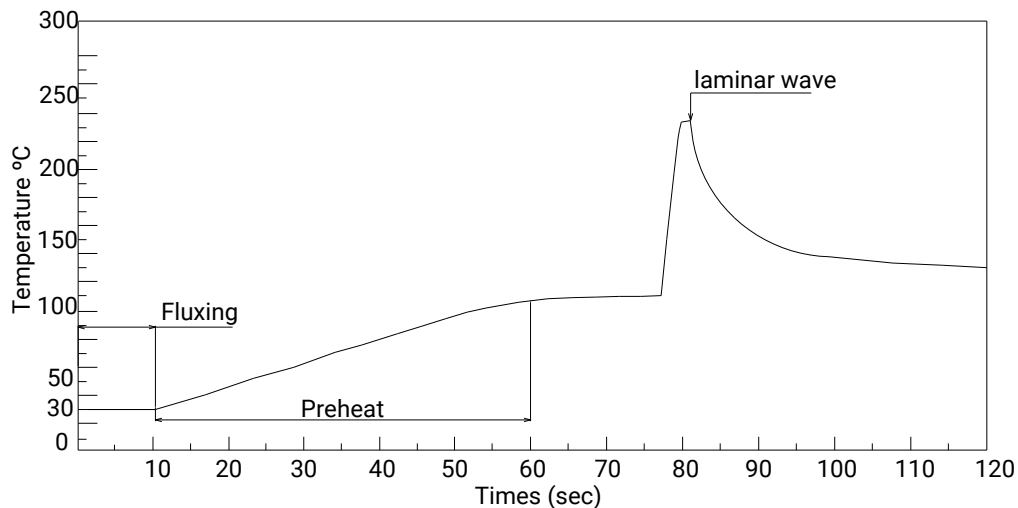

- Do not apply any stress to the LED package, particularly when heated.
- Only bottom preheat is suggested & should not preheat on top in order to reduce thermal stress experienced by the LEDs.
- The LEDs must not be re used once they have been extracted from PCB.
- After soldering the LEDs, the package should be protected from mechanical shock or vibration until the LEDs have reached 40 °C or below.
- Precautions must be taken as mechanical stress on the LEDs may be caused by PCB warpage or from the clinching and cutting of the LED leads.
- When it is necessary to clamp the LEDs during soldering, it is important to ensure no mechanical stress is exerted on the LEDs.
- Cut the LED lead at normal room temperature. Lead cutting at high temperature may cause failure of the LEDs.

Refer to "<http://www.cree.com/led-components/media/documents/sh-HB.pdf>" for soldering & handling details.

PACKAGING

Features:

- The LEDs are packed in cardboard boxes after packaging in normal or anti-electrostatic bags.
- Cardboard boxes will be used to protect the LEDs from mechanical shock during transportation.
- The boxes are not water resistant, and they must be kept away from water and moisture.
- The Bulk Pack types of packaging.
- Max 1000 pcs per bulk and Max 3000 pcs per ammo.

Bulk Pack Packaging Type:

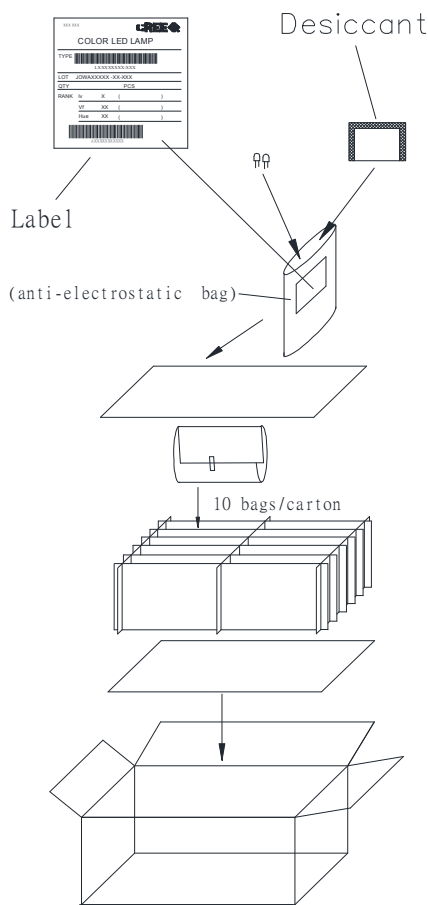

Ammo Pack Packaging Type:

