

# ENGINEERING DATA SHEET

# SERIES JA

RELAY - NONLATCH - AC COIL  
2 PDT, 10 AMP

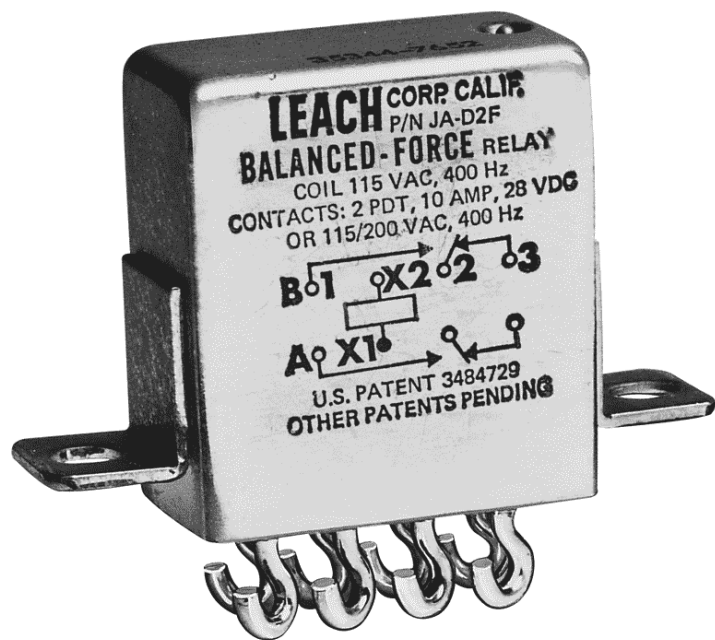

**APPLICATION NOTES:**

- [102](#)
- [007](#)
- [023](#)

**APPLICABLE SOCKET:**

- [SO-1049-8772/8774](#)
- [SO-SSL](#)

115 Vac and 28 Vac, 400 Hz and 50/400 Hz Coil Voltages  
All welded construction

Contact arrangement **2 PDT**  
Qualified to **MIL-PRF-83536**

**PRINCIPLE TECHNICAL CHARACTERISTICS**

Contacts rated at **28 Vdc; 115 Vac, 400 Hz, 1Ø and 115/200 Vac, 400 Hz, 3Ø**

Weight **0.088lb max**  
Dimensions **1.01in x .51in x 1.12in**  
Special models available upon request.

Hermetically sealed, corrosion resistant metal can.

**CONTACT ELECTRICAL CHARACTERISTICS**

Contact rating per pole and load type [1]	Load current in Amps				
	@28 Vdc	@115 Vac 400 Hz	@115/200 Vac 400 Hz, 3Ø	@115/200 Vac 60 Hz, 3Ø [6]	@230/400 Vac 400 Hz, 3Ø [8]
Resistive	10	10	10	2.5	5
Inductive [5]	8	8	8	2.5	5
Motor	4	4	4	2	2
Lamp	2	2	-	-	-
Overload	40	60	60	N/A	N/A
Rupture	50	80	80	N/A	N/A



Featuring **LEACH**® power and control solutions  
[www.esterline.com](http://www.esterline.com)

**AMERICAS**  
6900 Orangethorpe Ave.  
P.O. Box 5032  
Buena Park, CA 90622

Tel: (01) 714-736-7599  
Fax: (01) 714-670-1145

**EUROPE**  
2 Rue Goethe  
57430 Sarralbe  
France

Tel: (33) 3 87 97 31 01  
Fax: (33) 3 87 97 96 86

**ASIA**  
Units 602-603 6/F Lakeside 1  
No.8 Science Park West Avenue  
Phase Two, Hong Kong Science Park  
Pak Shek Kok, Tai Po, N.T.  
Hong Kong

Tel: (852) 2 191 3830  
Fax: (852) 2 389 5803

Data sheets are for initial product selection and comparison. Contact Esterline Power Systems prior to choosing a component.

**COIL CHARACTERISTICS (Vac)****SERIES JA**

	Vac 400 Hz		Vac 50 thru 400 Hz		Vac 400 Hz [6]
	E	F	J	K	T
Nominal operating voltage	28	115	28	115	230
Maximum operating voltage	30	122	30	122	248
Maximum pickup voltage					
- Cold coil at +125° C	22	90	23	95	180
- During high temp test at +125° C	24.4	95.4	24.6	100	185
- During continuous current test at +125° C	25.6	103.5	25.9	105	195
Maximum drop-out voltage	10	30	10	30	60
Coil current max milliAmperes at +25° C	240	40	100	24	22

**GENERAL CHARACTERISTICS**

Temperature range	-70°C to +125°C
Minimum operating cycles (life) at rated load	100,000
Minimum operating cycles (life) at 25% rated load	400,000
Dielectric strength at sea level	
- All circuits to ground and circuit to circuit	1250 Vrms
- Coil to ground	1000 Vrms
Dielectric strength at altitude 80,000 ft	500 Vrms [2]
Insulation resistance	
- Initial (500 Vdc)	100 M Ω min
- After environmental tests (500 Vdc)	50 M Ω min
Sinusoidal vibration (A, D and J mounting)	0.12DA / 10 to 70 Hz 30G / 70 to 3000 Hz
Sinusoidal vibration (G mounting)	0.12DA / 10 to 57 Hz 20G / 57 to 3000 Hz
Random vibration	
- Applicable specification	MIL-STD-202
- Method	214
- Test condition - A, D and J mounting	1G (0.4G <sup>2</sup> /Hz, 50 to 2000 Hz)
- Test condition - G mounting (E in track)	1E (0.2G <sup>2</sup> /Hz, 50 to 2000 Hz)
- Duration	15 minutes each plane
Shock (A, D and J mounting)	200G / 6 ms
Shock (G mounting)	100G / 6 ms
Maximum contact opening time under vibration and shock	10 μs
Operate time at nominal voltage@25°C	15 ms max
Release time at nominal voltage@25°C	50 ms max
Contact make bounce at nominal voltage@25°C	1 ms max
Contact release break bounce at nominal voltage@25°C	0.1 ms max
Weight maximum	0.088lb

Unless otherwise noted, the specified temperature range applies to all relay characteristics.

- [1] Standard Intermediate current test applicable.
- [2] 500 Vrms with silicone gasket compressed, 350 Vrms all other conditions.
- 3. Applicable military specification: MIL-PRF-83536/11.
- 4. Special models available: Dry circuit, established reliability testing, etc.
- 5. Inductive load life, 20,000 cycles for AC and 10,000 cycles for DC.
- [6] 60 Hz load life, 10,000 cycles.
- 7. Time current relay characteristics per MIL-R-83536.
- [8] Temperature range:
  - Non-operating -62° C to +95° C
  - Operating -54° C to +71° C

NUMBERING SYSTEM

	JA	-	A	1	F
Basic series designation _____					
1-Mounting Style (A,D,G,J) _____					
2-Terminal Types (1,2,4) _____					
3-Coil Voltage see coil characteristics (E,F,J,K, or T) _____					

MOUNTING STYLES

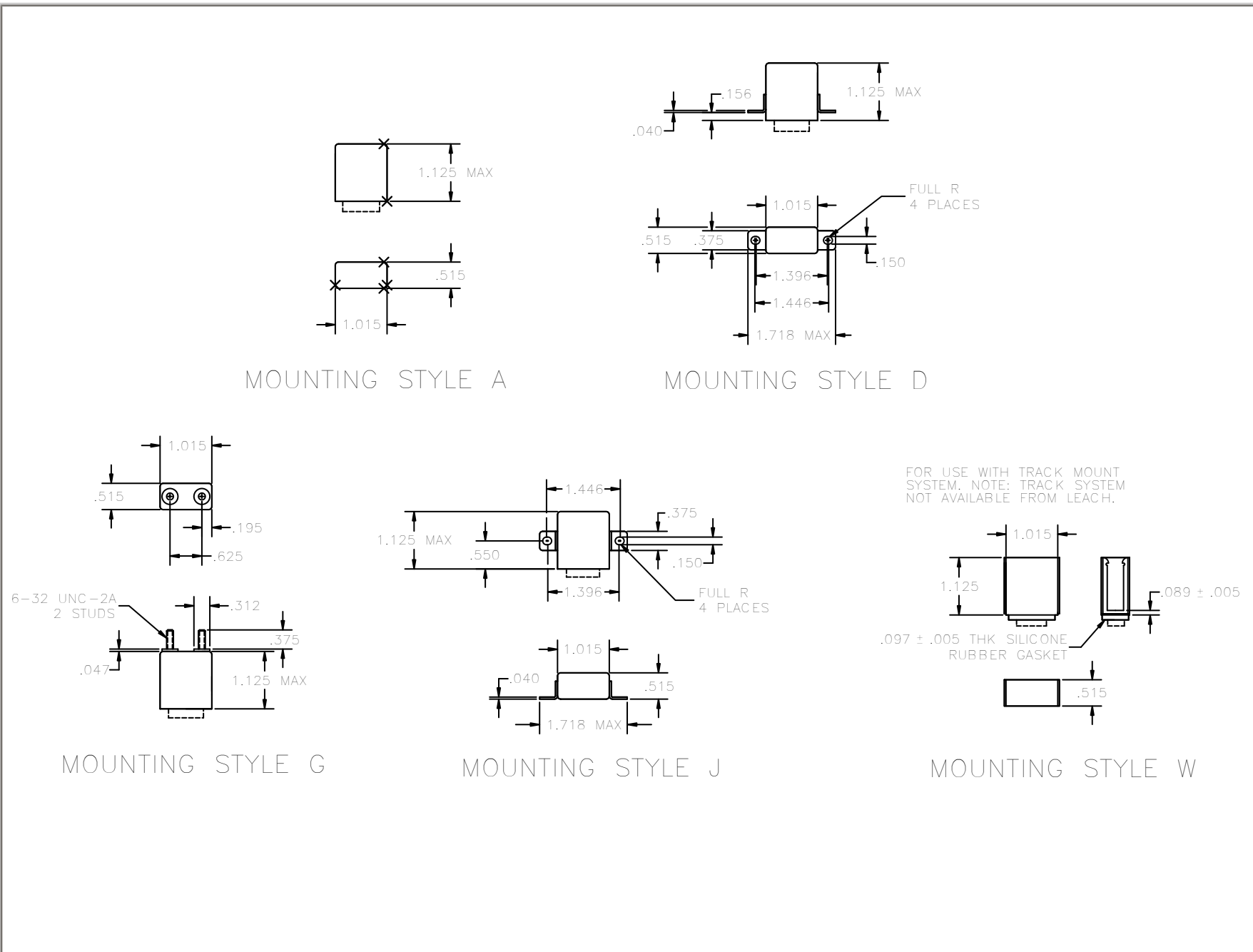

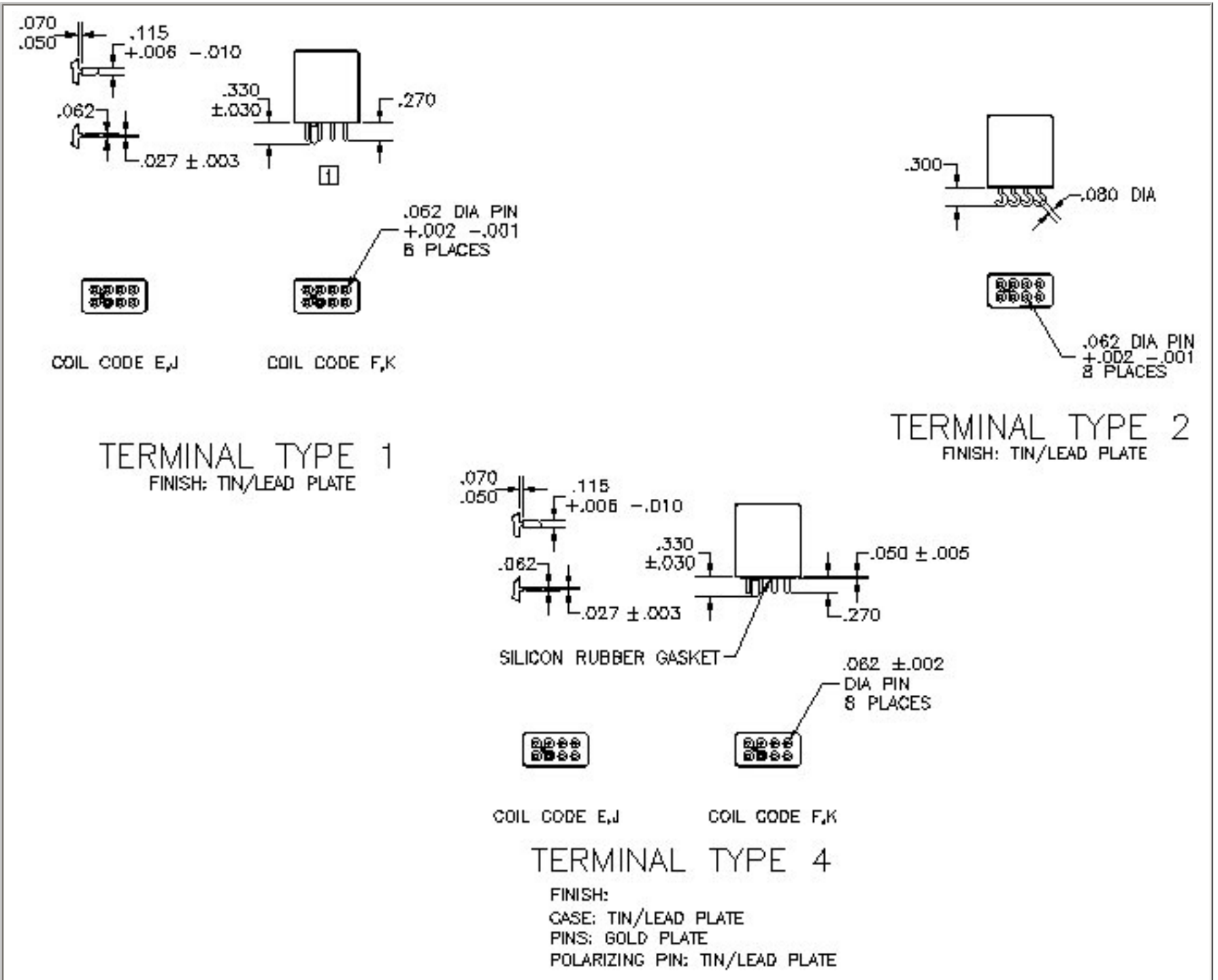

Standard Tolerance: ± .010

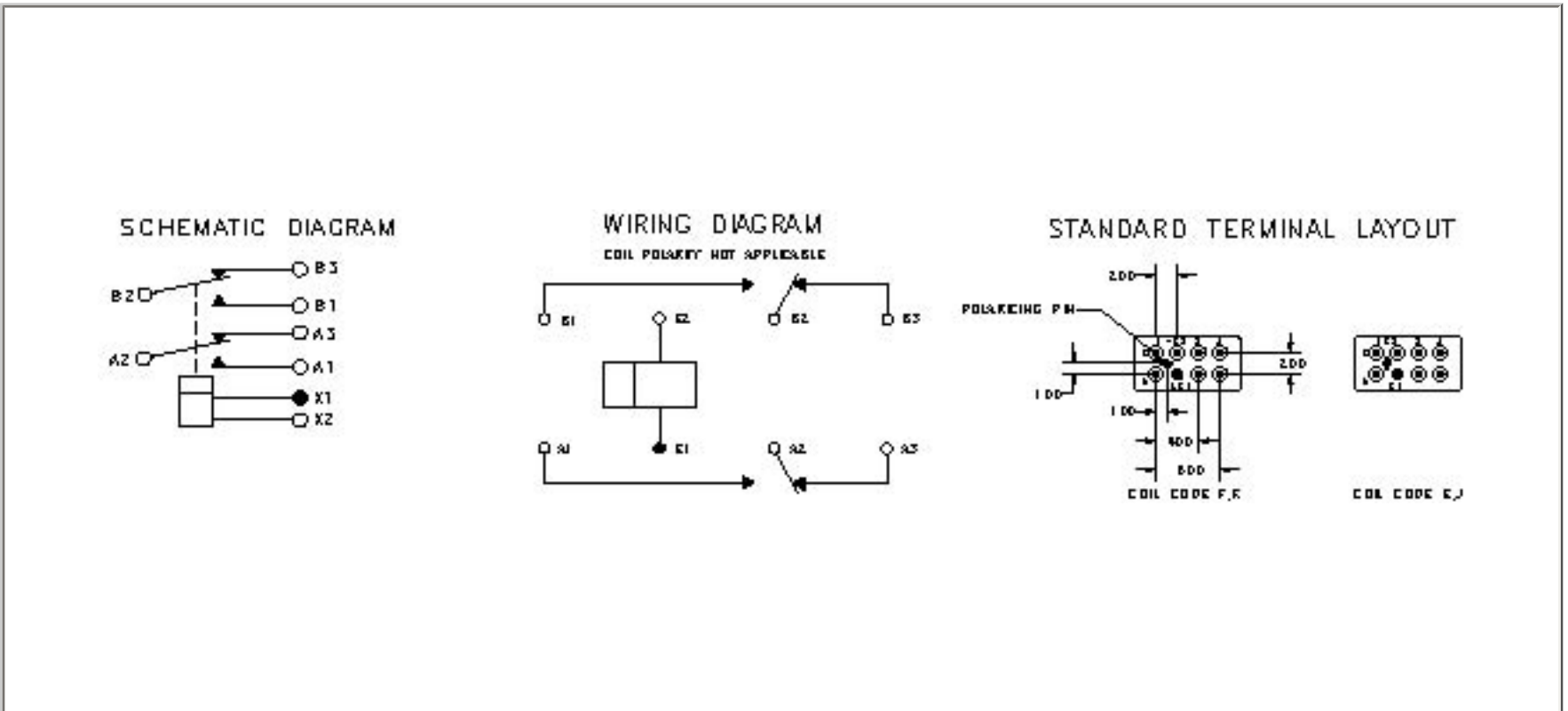

[1] COIL POLARITY NOT APPLICABLE

## RELAYS AND TEMPERATURE VARIATIONS

Most relay parameters are specified as maximum values over the rated temperature range of the specific relay. Users often find that key parameters differ significantly at ambient temperature (20-25°C) and sometimes fall into the trap of specifying their system around these ambient parameters. Additionally the actual temperature experienced by the relay can be far in excess of existing ambient temperatures due to the heat generated by the coil current and the contact load. Figure 1 is the summary of temperature effects on relay electrical characteristics.

Temperature	Resistance	Current	Operating Voltage	Release Voltage	Operate Time	Release Time
Increase	UP	DOWN	UP	UP	UP	UP
Decrease	DOWN	UP	DOWN	DOWN	DOWN	DOWN

**Fig. 1**

The following formulas are sometimes useful in calculating the effects shown above.

1. Change in coil resistance due to change of ambient temperature can be calculated by the following formula.

$$R = R_{20} [1 + .0039 (T-20)]$$

Where: R = Coil resistance at given temperature  
 $R_{20}$  = Coil resistance at 20°C  
 T = °C Ambient temperature

"Rule of Thumb" : For each 10°C change of temperature, coil resistance will change approximately 4%.

2. High and low temperature pick up voltage:

$$E_2 = E_1 K_2,$$

Where:  $E_2$  = Pick Up Voltage at  $T_2$  temperature  
 $E_1$  = Pick Up Voltage at 20°C  
 $K_2$  = Coefficient of correction found on the graph in Fig. 2 at  $T_2$

3. Calculation of coil temperature rise when R initial and R final are known:

$$\Delta T = (234.5 + T_1) (R_2/R_1 - 1)$$

$\Delta T$  = Temperature rise (°C)

$T_1$  = Initial temperature (°C)

$R_1$  = Initial resistance (Ohms)

$R_2$  = Final resistance (Ohms)

$$R_2 = K_2 R_1$$

Temperature can also be found by making the  $R_2/R_1$  ratio = the coefficient of correction graph in Fig. 2, and then finding the corresponding temperature.

### TEMPERATURE CORRECTION CHART FOR RESISTANCE

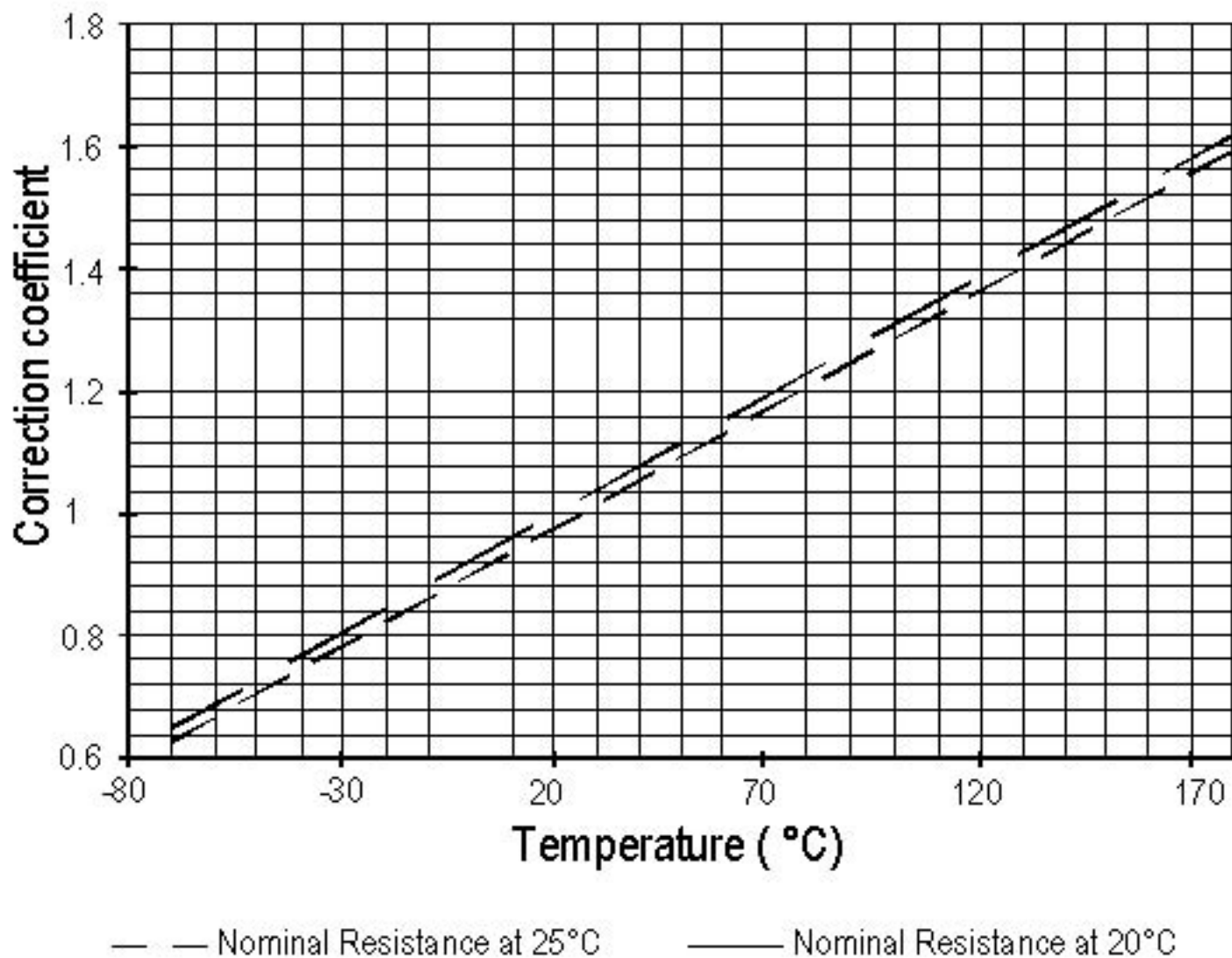

Fig. 2

EXAMPLE:

Catalog indicates coil resistance of 290 ohm at 25°C. What is the value at 125°C?

From the chart:  $290 \times 1.39 = 403.31$  Ohms.

### SUPPRESSOR DEVICES FOR RELAY COILS

The inductive nature of relay coils allows them to create magnetic forces which are converted to mechanical movements to operate contact systems. When voltage is applied to a coil, the resulting current generates a magnetic flux, creating mechanical work. Upon deenergizing the coil, the collapsing magnetic field induces a reverse voltage (also known as back EMF) which tends to maintain current flow in the coil. The induced voltage level mainly depends on the duration of the deenergization. The faster the switch-off, the higher the induced voltage.

All coil suppression networks are based on a reduction of speed of current decay. This reduction may also slow down the opening of contacts, adversely effecting contact life and reliability. Therefore, it is very important to have a clear understanding of these phenomena when designing a coil suppression circuitry.

#### Typical coil characteristics

On the graph below, the upper record shows the contacts state. (High level NO contacts closed, low level NC contacts closed, intermediate state contact transfer). The lower record shows the voltage across the coil when the current is switched off by another relay contact.

The surge voltage is limited to -300V by the arc generated across contact poles. Discharge duration is about 200 microseconds after which the current change does not generate sufficient voltage. The voltage decreases to the point where the contacts start to move, at this time, the voltage increases due to the energy contained in the NO contact springs. The voltage decreases again during transfer, and increases once more when the magnetic circuit is closed on permanent magnet.

Operating times are as follows:  
 Time to start the movement 1.5ms  
 Total motion time 2.3ms  
 Transfer time 1.4ms

Contact State

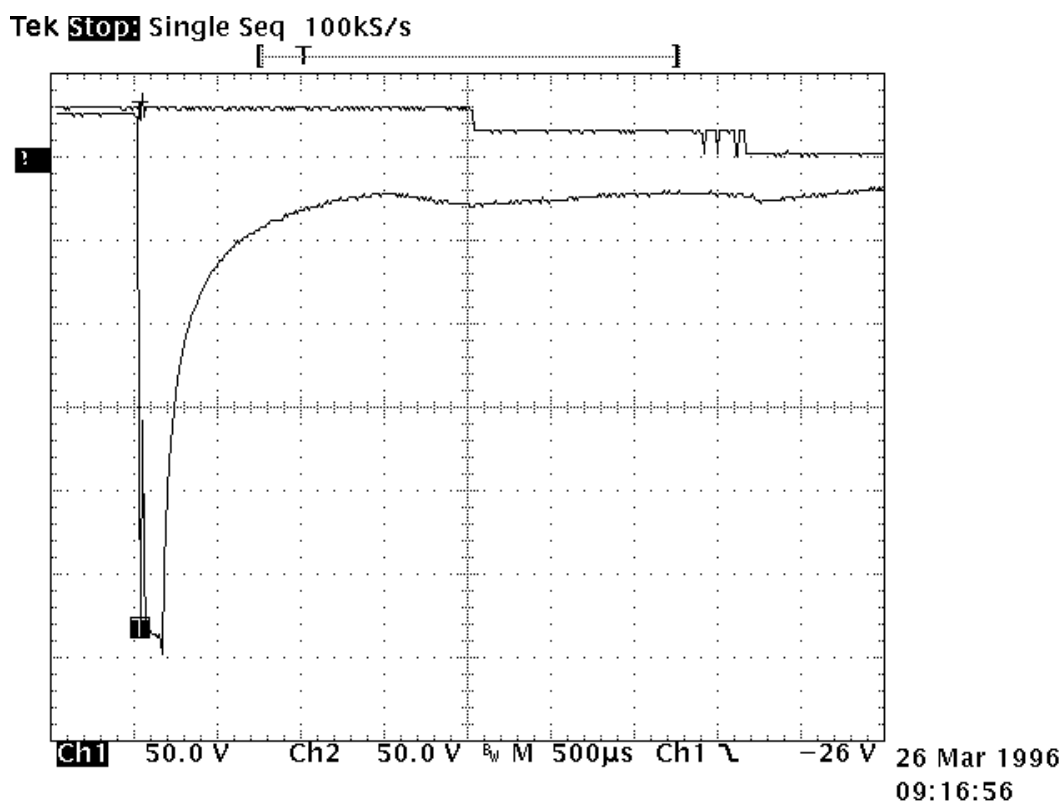

## Types of suppressors:

### Passive devices.

#### The resistor capacitor circuit

It eliminates the power dissipation problem, as well as fast voltage rises. With a proper match between coil and resistor, approximate capacitance value can be calculated from:

$C = 0.02 \times T/R$ , where

T = operating time in milliseconds

R = coil resistance in kiloOhms

C = capacitance in microFarads

The series resistor must be between 0.5 and 1 times the coil resistance. Special consideration must be taken for the capacitor inrush current in the case of a low resistance coil.

The record shown opposite is performed on the same relay as above. The operation time becomes:

- time to start the movement 2.3ms

- transfer time 1.2ms

The major difficulty comes from the capacitor volume. In our example of a relay with a  $290 \Omega$  coil and time delay of 8 ms, a capacitance value of  $C=0.5 \mu\text{F}$  is found. This non polarized capacitor, with a voltage of 63V minimum, has a volume of about  $1\text{cm}^3$ . For 150V, this volume becomes  $1.5 \text{cm}^3$ .

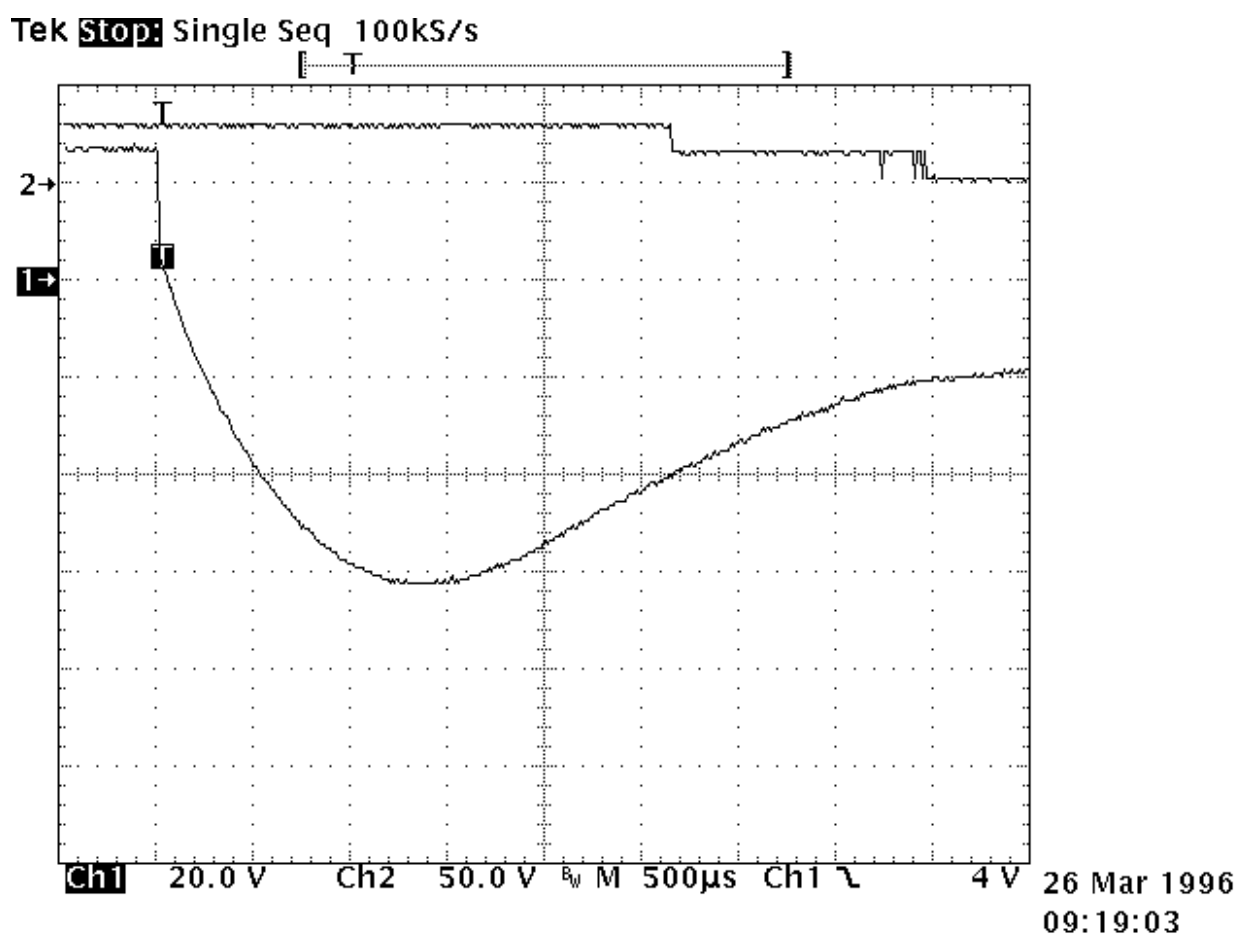



### The bifilar coil

The principle is to wind on the magnetic circuit of the main coil a second coil shorted on itself. By a proper adaptation of the internal resistance of this second coil it is possible to find an acceptable equilibrium between surge voltage and reduction of the opening speed. To be efficient at fast voltage changes, the coupling of two coils must be perfect. This implies embedded windings. The volume occupied by the second coil reduces the efficiency of the main coil and results in higher coil power consumption. This method cannot be applied efficiently to products not specifically designed for this purpose.

### The resistor (parallel with the coil)

For efficient action, the resistor must be of the same order of magnitude as the coil resistance. A resistor 1.5 times the coil resistance will limit the surge to 1.5 times the supply voltage. Release time and opening speed are moderately affected. The major problem is the extra power dissipated.

### **Semi-conductor devices**

#### The diode

It is the most simple method to totally suppress the surge voltage. It has the major disadvantage of the higher reduction of contact opening speed. This is due to the total recycling, through the diode, of the energy contained in the coil itself. The following measurement is performed once again on the same relay. Operation times are given by the upper curve:

- time to start the movement 14ms
- transfer time 5ms

These times are multiplied by a coefficient from 4 to 8.

The lower curve shows the coil current. The increase prior to NO contact opening indicates that the contact spring dissipates its energy. At the opening time the current becomes constant as a result of practically zero opening speed.

Due to this kind of behavior, this type of suppression must be avoided for power relays. For small relays which have to switch low currents of less than 0.2 A, degradation of life is not that significant and the method may be acceptable.

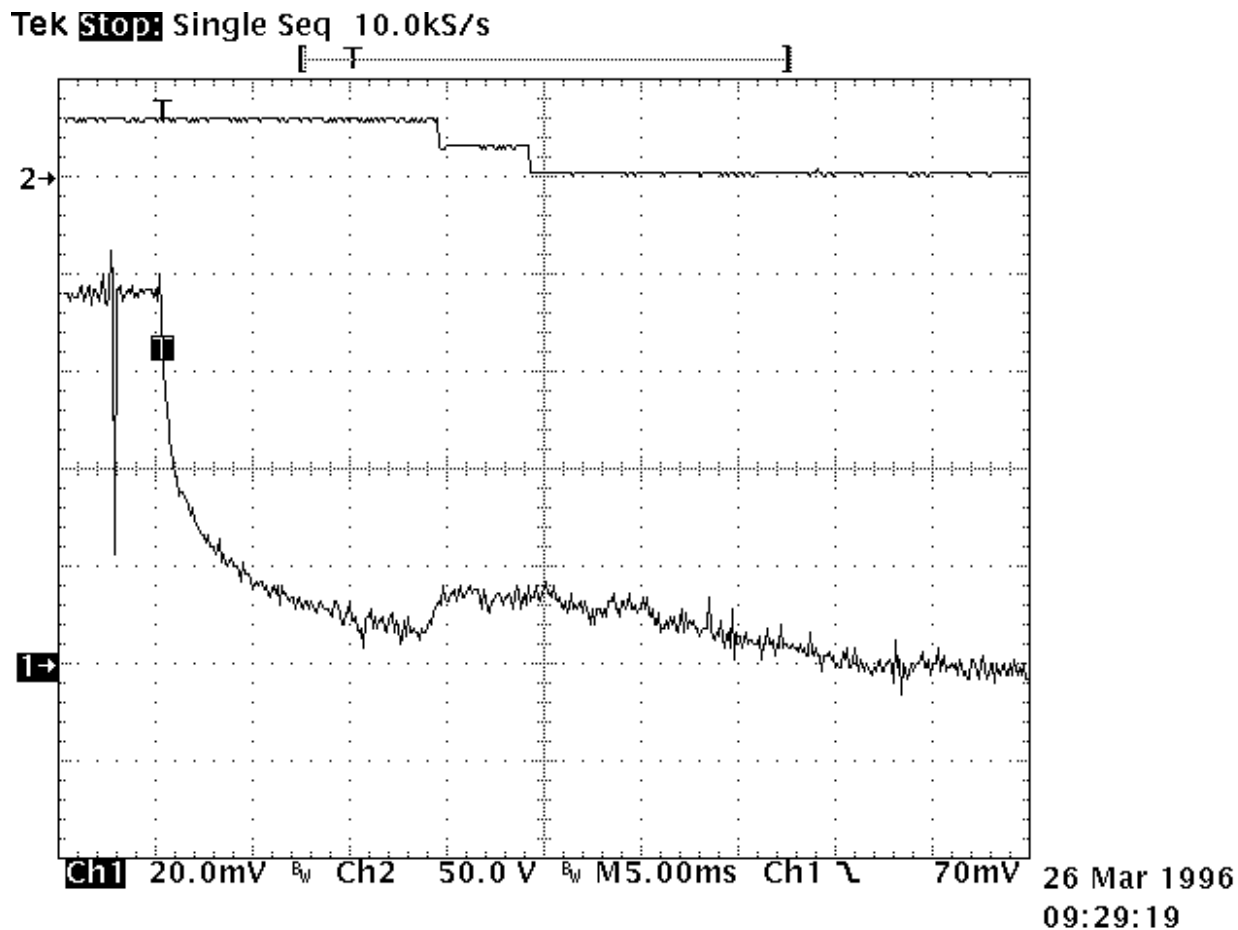

The diode + resistor network

It eliminates the inconvenience of the resistor alone, explained above, and it limits the action of a single diode. It is now preferred to use the diode + zener network.

The diode + zener network

Like the resistor, the zener allows a faster decurrent decay. In addition it introduces a threshold level for current conduction which avoids the recycling of energy released during contact movement.

The lower curve on the opposite record demonstrates those characteristics. Voltage limitation occurs at 42V. The two voltage spikes generated by internal movement are at lower levels than zener conduction. As a result, no current is recycled in the coil.

The opening time phases are as follows:

- time to start the movement 2.6ms
- total motion time 2.4ms
- transfer time 1.4ms

The release time is slightly increased. The contacts' opening speed remains unchanged.

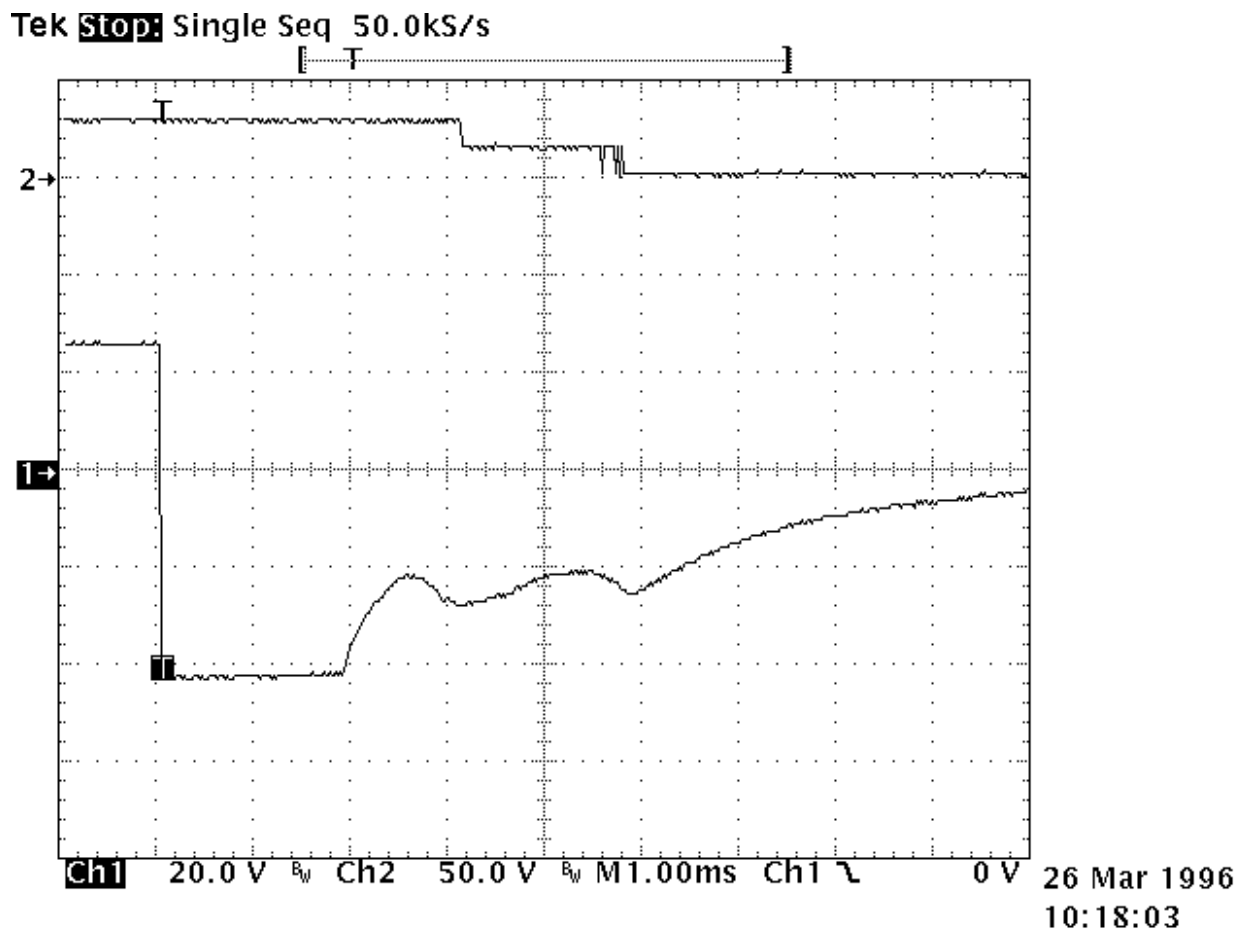

**MOUNTING DISTANCE BETWEEN RELAYS**

Applicable to XL, X, XA, XCL, XC,  
YL, Y, YA, YCL, YC, YCA,  
JS/JSA, JA, JL, J,  
KA, KL, K

**Definition and applicability**

This application note defines the minimum distance between relays to insure relay performance as specified in our data sheets.

**Phenomenon analysis**

Each relay generates a magnetic field either when the relay is de-energized because of the permanent magnet or in the energized position because of permanent magnet and coil. The magnetic field generated by one relay could affect the performance of another relay when the below minimum distance between relays is not respected. If the relays are mounted adjacent to each other, it is advisable to alternate direction of magnetic path on every other unit and to keep a 1/16-inch space between relays (figure "A"). Or when mounted in the same direction, separate each relay from the other by 1/8 inch (figure "B"). If two or more rows of relays are installed, allow clearance of 1/8 inch between rows, (figures "C" and "D"). Provide 3/16-inch space between relays if used in opposition (figure "E").

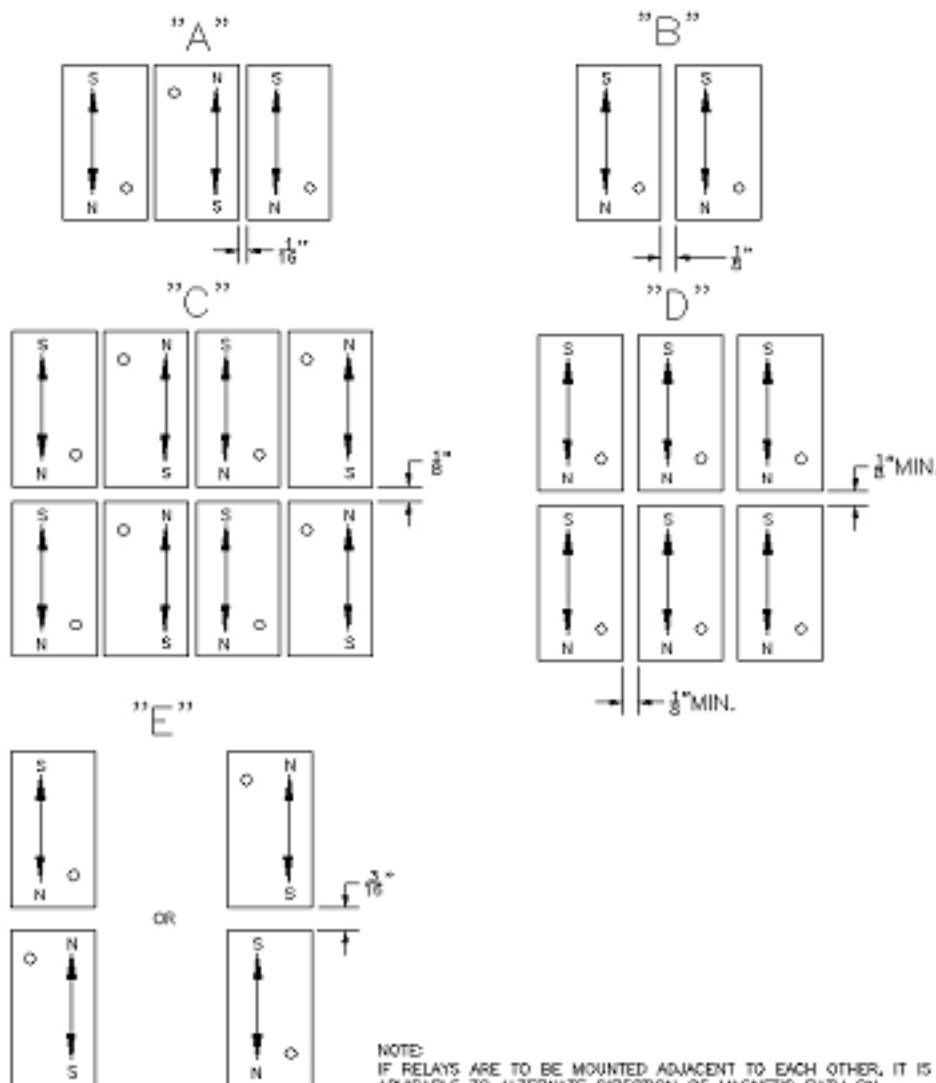

NOTE:  
IF RELAYS ARE TO BE MOUNTED ADJACENT TO EACH OTHER, IT IS ADVISABLE TO ALTERNATE DIRECTION OF MAGNETIC PATH ON EVERY OTHER UNIT AND TO KEEP A 1/16" SPACE BETWEEN RELAYS, FIGURE "A". OR, WHEN MOUNTED IN SAME DIRECTION SEPARATE EACH RELAY FROM THE OTHER BY 1/8 INCH MINIMUM, "B". IF TWO OR MORE ROWS OF RELAYS ARE TO BE INSTALLED, ALLOW CLEARANCE OF 1/8 INCH MINIMUM BETWEEN ROWS, "C" AND "D". PROVIDE FOR 3/16" SPACE BETWEEN RELAYS IF USED IN OPPOSING MAGNETIC DIRECTION, "E". REASONABLE CHANGE IN OPERATE VALUES MAY OCCUR IF INSTRUCTIONS ARE NOT FOLLOWED.

# SO-1049-8772/8774

## ENGINEERING DATA SHEET

RELAY SOCKET  
10 AMP



BASIC SOCKET SERIES DESIGNATION FOR:

**Series JA**

MEETS THE REQUIREMENTS OF:

**MIL-DTL-12883**

### SOCKET DRAWING

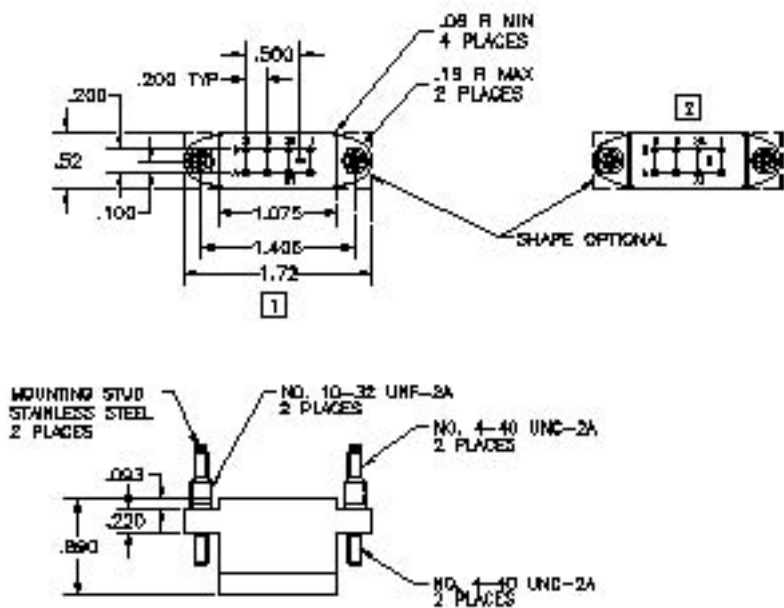

### HARDWARE MOUNTING

#### MOUNTING DETAIL

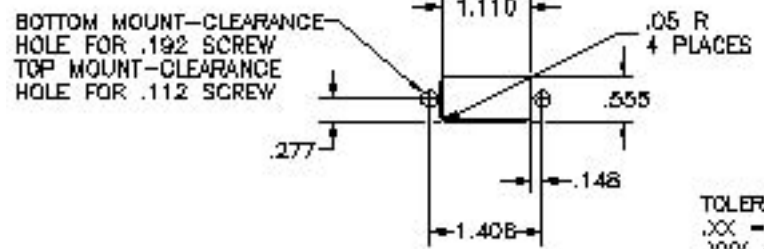
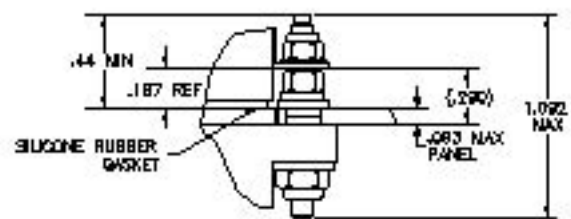

TOLERANCE:  
.XX = .03  
.XXX = .010

### MOUNTING DIMENSIONS

## GENERAL CHARACTERISTICS

[1] Supplied with mounting hardware and No. 16 contacts, No. 16 crimp for coil 115 Vac, rear release (SO-1049-8772)

[2] Supplied with mounting hardware and No. 16 contacts, No. 16 crimp for coil 28 Vac, rear release (SO-1049-8774)

3. Standard tolerances .xx ±.01; xxx ±.005

4. Weight .073 lb. max

[5] Temperature range -70° C to +125° C



Featuring **LEACH**® power and control solutions  
www.esterline.com

**AMERICAS**  
6900 Orangethorpe Ave.  
P.O. Box 5032  
Buena Park, CA 90622

**EUROPE**  
2 Rue Goethe  
57430 Sarralbe  
France

**ASIA**  
Units 602-603 6/F Lakeside 1  
No.8 Science Park West Avenue  
Phase Two, Hong Kong Science Park  
Pak Shek Kok, Tai Po, N.T.  
Hong Kong

Tel: (01) 714-736-7599  
Fax: (01) 714-670-1145

Tel: (33) 3 87 97 31 01  
Fax: (33) 3 87 97 96 86

Tel: (852) 2 191 3830  
Fax: (852) 2 389 5803

Data sheets are for initial product selection and comparison. Contact Esterline Power Systems prior to choosing a component.



2 POLE



4

POLE

SNAP AND LOCK SOCKET SERIES DESIGNATION FOR:

**SERIES J, JA, K, KA, KL, TDX**

MEETS THE REQUIREMENTS OF:

2-pole, 10A relays **MIL-PRF-12883/41**

Mates with **M83536, M83726 and MS27709**

4-pole, 10A relays **MIL-PRF-12883/40**

Mates with **M83536**

**FEATURES**

Low profile

Bottom panel mount

Snaps into panel

Other models available

**MATERIALS**

Socket body **Polyetherimide per MIL-P-46184**

Grommet **Silicone rubber per ZZ-R-765**

Hardware **Stainless Steel**

Contacts **Copper alloy, hard gold plated per MIL-G-45204**

Contact retainers **Beryllium copper**

**GENERAL CHARACTERISTICS**

Insulation resistance	1000 M $\Omega$ min.
Dielectric withstanding voltage	1500 VRMS sea level; 500 VRMS at 80,000 ft
Weight	15.3g max.
Temperature range	-65°C to +125°C
Vibration	MIL-STD-202, Method 204, Test Condition G
Shock	MIL-STD-202, Method 213, Test Condition C

This socket is designed to snap and lock into a panel to reduce hardware requirement and mounting time. Contacts and hardware are provided disassembled in a plastic bag. Standard tolerances are .xx= $\pm$ .01; .xxx= $\pm$ .005 unless otherwise noted.



Featuring **LEACH**® power and control solutions  
www.esterline.com

**AMERICAS**  
6900 Orangethorpe Ave.  
P.O. Box 5032  
Buena Park, CA 90622

Tel: (01) 714-736-7599  
Fax: (01) 714-670-1145

**EUROPE**  
2 Rue Goethe  
57430 Sarralbe  
France

Tel: (33) 3 87 97 31 01  
Fax: (33) 3 87 97 96 86

**ASIA**  
Units 602-603 6/F Lakeside 1  
No.8 Science Park West Avenue  
Phase Two, Hong Kong Science Park  
Pak Shek Kok, Tai Po, N.T.  
Hong Kong  
Tel: (852) 2 191 3830  
Fax: (852) 2 389 5803

Data sheets are for initial product selection and comparison. Contact Esterline Power Systems prior to choosing a component.

# SOCKET DIMENSIONS

# SO-SSL (2 POLE)

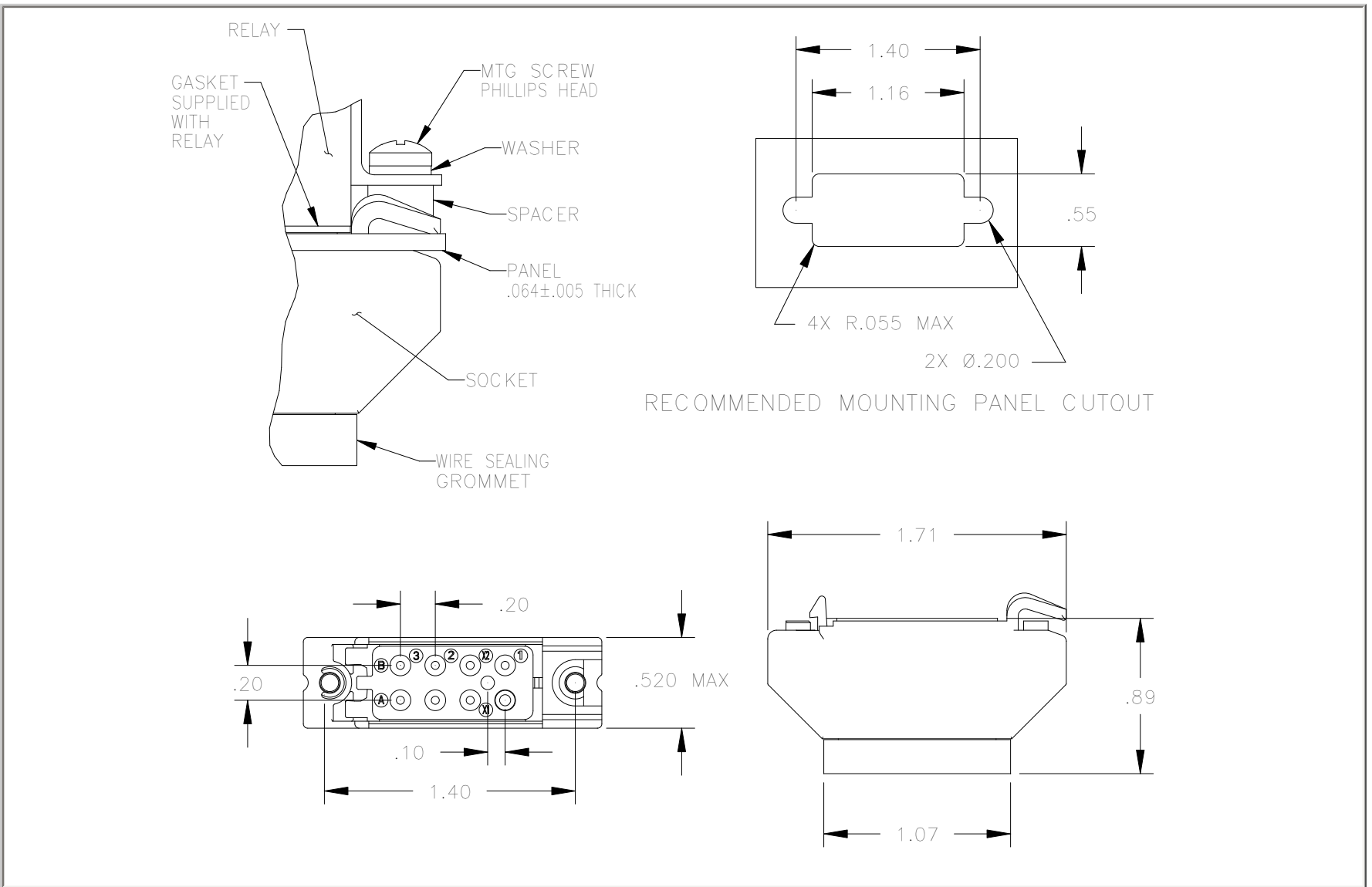

# TERMINAL LAYOUT

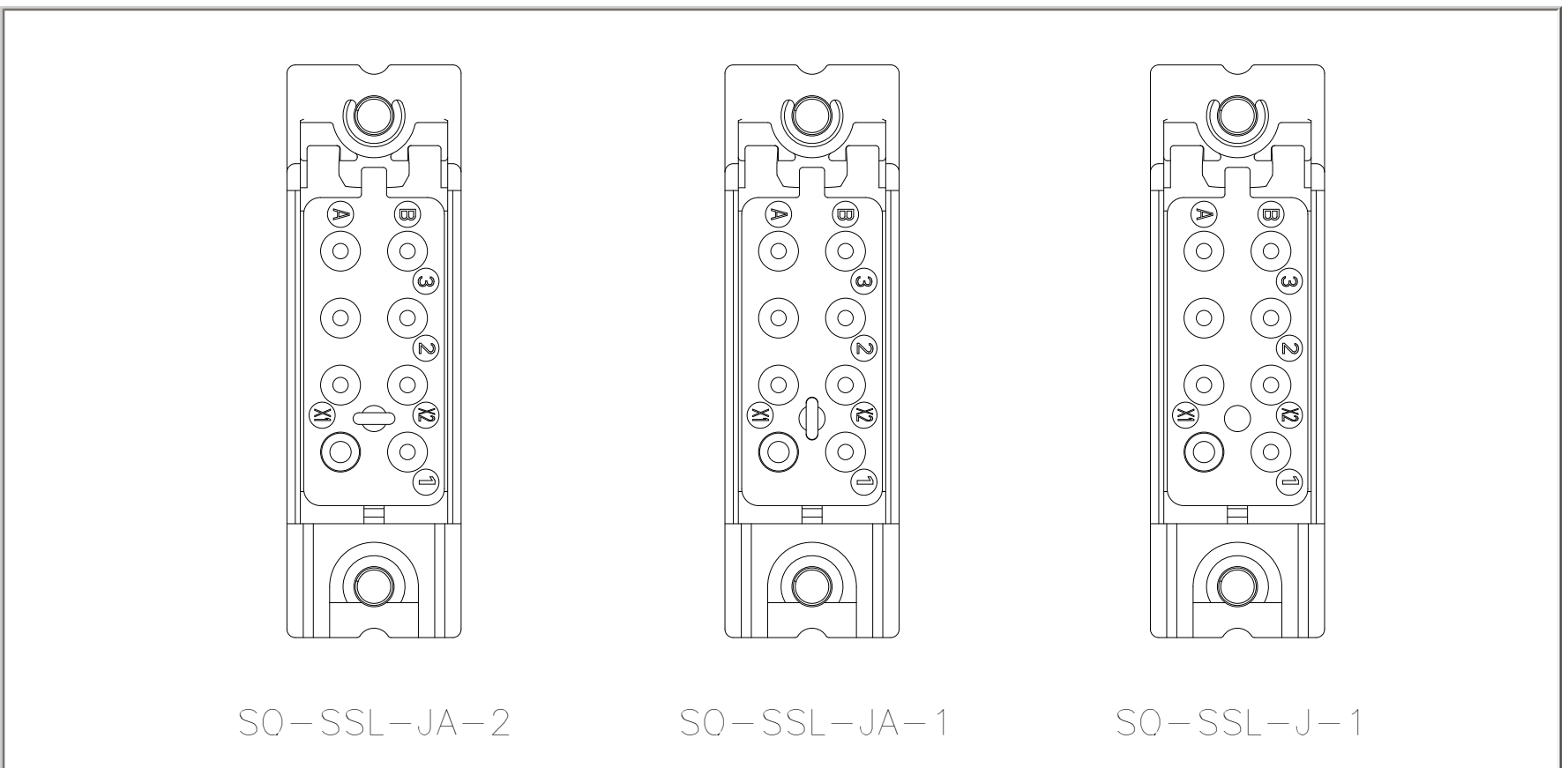

# SOCKET DIMENSIONS

# SO-SSL (4 POLE)

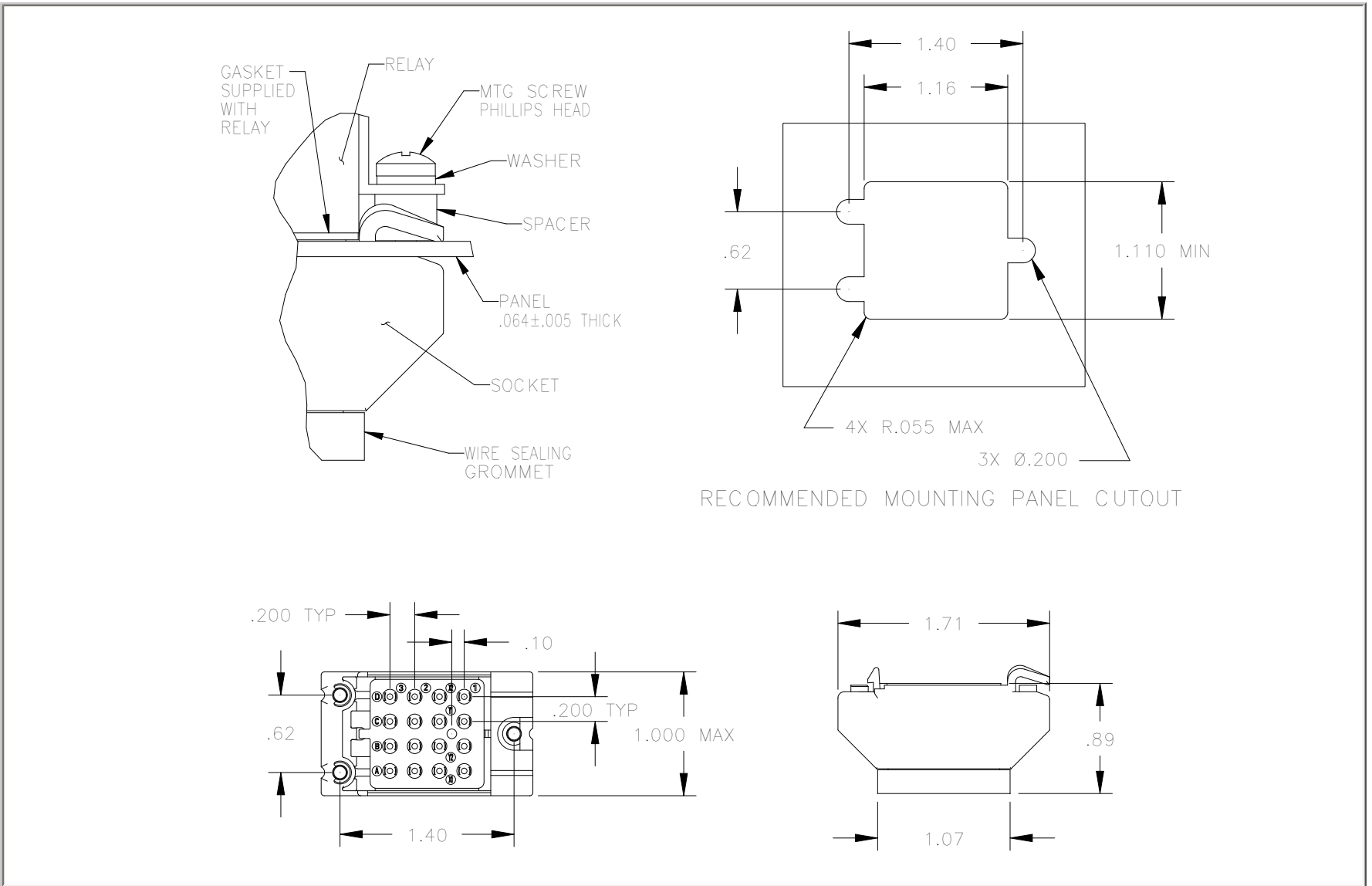

# TERMINAL LAYOUT

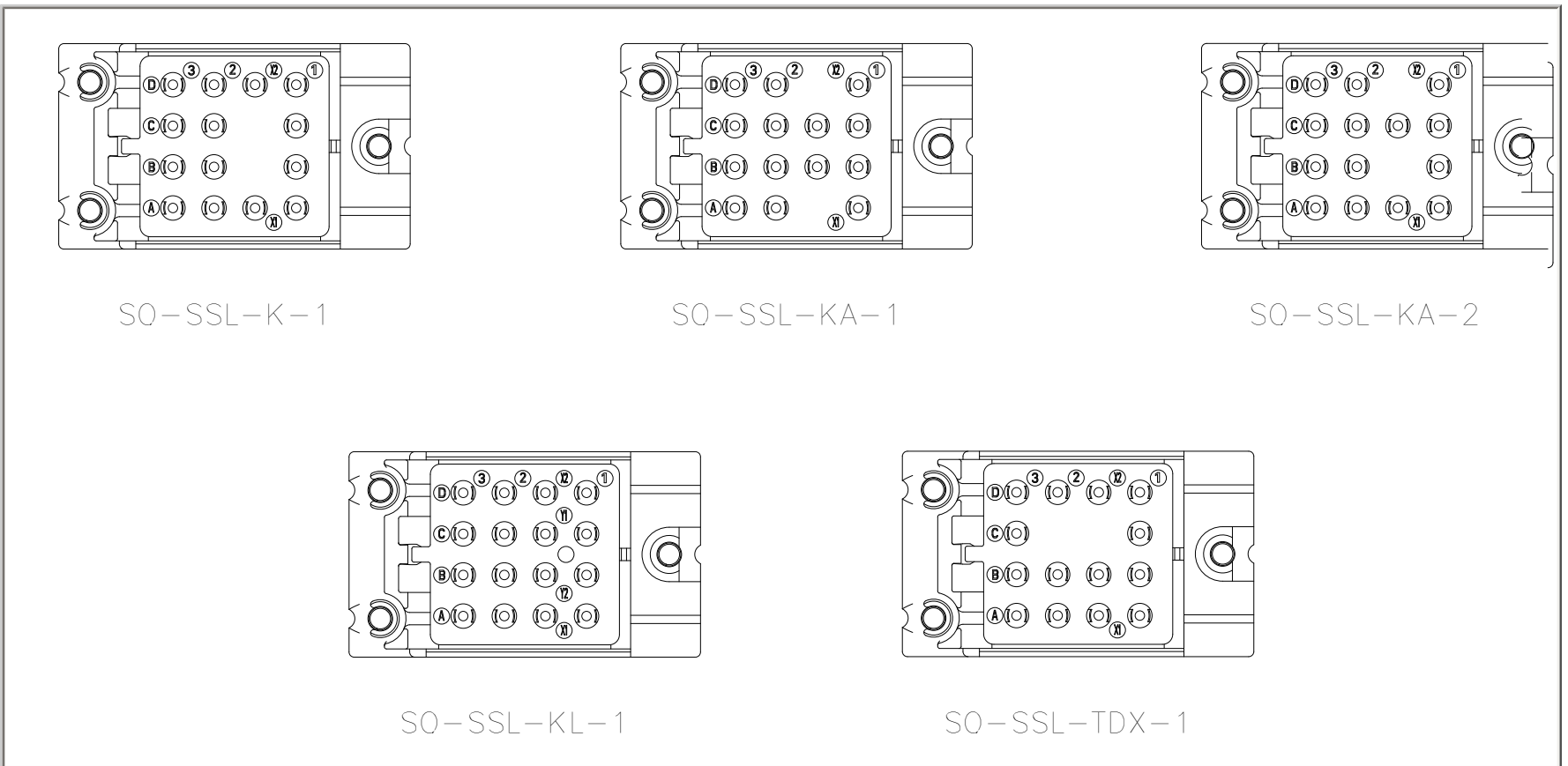

	SO	SSL	KA	001
1-Basic socket designation_____				
2-Body style (short snap lock)_____				
3-Mating relay (J, JA, K, KA, KL, TDX)_____				
4-Polarization (see terminal layout)_____				
5-Hardware (0=less hardware, 1=with hardware)_____				
6-Contacts (0=less contacts, 1=with contacts)_____				



## **X-ON Electronics**

Largest Supplier of Electrical and Electronic Components

*Click to view similar products for [esterline](#) manufacturer:*

Other Similar products are found below :

[KC-A1N](#) [M83536/32-003L](#) [SO-1056-8691](#) [9123-8070](#) [K-D4A](#) [X-J7B](#) [S320-A1A10](#) [J-J7A-012](#) [VS-455-1](#) [TDH-2016-1002](#) [M83536/5-024M](#)  
[S283A004-7](#) [9130G-10677](#) [9524-6507](#) [X-A2N](#) [X-A1N](#) [KL-D4L-029](#) [TDH-7101-2002](#) [JC-D1N](#) [Y-D4N-300L](#) [002-5089-000](#) [JA-D4E](#)  
[M83726/30-1001P](#) [002-3261-000](#) [M83726/24-1001](#) [M6106/19-017](#)