

Kingbright®

3.0x1.0mm RIGHT ANGLE SMD CHIP LED LAMPS

KPA-3010

Features

- 3.0mmx1.0mm SMT LED. 2.0mm THICKNESS.
- LOW POWER CONSUMPTION.
- WIDE VIEWING ANGLE.
- IDEAL FOR BACKLIGHT AND INDICATOR.
- VARIOUS COLORS AND LENS TYPES AVAILABLE.

Description

The Bright Red source color devices are made with Gallium Phosphide Red Light Emitting Diode.

The Super Bright Green source color devices are made with Gallium Phosphide Green Light Emitting Diode.

The High Efficiency Red source color devices are made with Gallium Arsenide Phosphide on Gallium Phosphide Orange Light Emitting Diode.

The Yellow source color devices are made with Gallium Arsenide Phosphide on Gallium Phosphide Yellow Light Emitting Diode.

The Super Bright Red source color devices are made with Gallium Aluminum Arsenide Red Light Emitting Diodes.

The Super Bright Yellow source color devices are made with DH InGaAlP on GaAs substrate Light Emitting Diode.

Package Dimensions

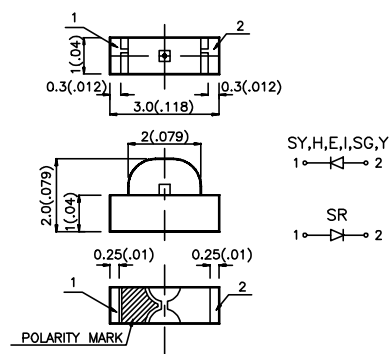

- Notes:
1. All dimensions are in millimeters (inches).
 2. Tolerance is ± 0.1 (0.004") unless otherwise noted.
 3. Lead spacing is measured where the lead emerge package.
 4. Specifications are subjected to change without notice.

Selection Guide

Part No.	Dice	Lens Type	Iv (mcd) @ 20 mA		Viewing Angle
			Min.	Typ.	
KPA-3010HD	BRIGHT RED (GaP)	RED DIFFUSED	0.8	1.25	120°
KPA-3010HC	BRIGHT RED (GaP)	WATER CLEAR	0.8	1.25	120°
KPA-3010HT	BRIGHT RED (GaP)	RED TRAS.	0.8	1.25	120°
KPA-3010ID	HIGH EFFICIENCY RED (GaAsP/GaP)	RED DIFFUSED	5	12.5	120°
KPA-3010EC	HIGH EFFICIENCY RED (GaAsP/GaP)	WATER CLEAR	5	12.5	120°
KPA-3010IT	HIGH EFFICIENCY RED (GaAsP/GaP)	RED TRNS.	5	12.5	120°
KPA-3010YD	YELLOW (GaAsP/GaP)	YELLOW DIFFUSED	3.2	8	120°
KPA-3010YC	YELLOW (GaAsP/GaP)	WATER CLEAR	3.2	8	120°
KPA-3010YT	YELLOW (GaAsP/GaP)	YELLOW TRNS.	3.2	8	120°
KPA-3010SRD	SUPER BRIGHT RED (GaAlAs)	RED DIFFUSED	40	70	120°
KPA-3010SRC	SUPER BRIGHT RED (GaAlAs)	WATER CLEAR	40	70	120°
KPA-3010SRT	SUPER BRIGHT RED (GaAlAs)	RED TRNS.	40	70	120°
KPA-3010SGD	SUPER BRIGHT GREEN (GaP)	GREEN DIFFUSED	3.2	12.5	120°
KPA-3010SGC	SUPER BRIGHT GREEN (GaP)	WATER CLEAR	3.2	12.5	120°
KPA-3010SGT	SUPER BRIGHT GREEN (GaP)	GREEN TRNS.	3.2	12.5	120°
KPA-30102SYD	SUPER BRIGHT YELLOW (InGaAlP)	YELLOW DIFFUSED	40	60	120°
KPA-3010SYC	SUPER BRIGHT YELLOW (InGaAlP)	WATER CLEAR	40	60	120°
KPA-3010SYT	SUPER BRIGHT YELLOW (InGaAlP)	YELLOW TRNS.	40	60	120°

Note:
1. $\theta_{1/2}$ is the angle from optical centerline where the luminous intensity is 1/2 the optical centerline value.

Electrical / Optical Characteristics at T_A=25°C

Symbol	Parameter	Device	Typ.	Max.	Units	Test Conditions
λ_{peak}	Peak Wavelength	Bright Red High Efficiency Red Yellow Super Bright Red Super Bright Green Super Bright Yellow	700 625 590 660 565 595		nm	IF=20mA
$\Delta\lambda_{1/2}$	Spectral Line Halfwidth	Bright Red High Efficiency Red Yellow Super Bright Red Super Bright Green Super Bright Yellow	45 45 35 20 30 20		nm	IF=20mA
C	Capacitance	Bright Red High Efficiency Red Yellow Super Bright Red Super Bright Green Super Bright Yellow	40 12 10 95 45 33		pF	VF=0V;f=1MHz
V _F	Forward Voltage	Bright Red High Efficiency Red Yellow Super Bright Red Super Bright Green Super Bright Yellow	2.0 2.0 2.1 1.85 2.2 2.0	2.5 2.5 2.5 2.5 2.5 2.4	V	IF=20mA
I _R	Reverse Current	All	10		uA	VR = 5V

Absolute Maximum Ratings at T_A=25°C

Parameter	Bright Red	High Efficiency Red	Yellow	Super Bright Red	Super Bright Green	Super Bright Yellow	Units
Power dissipation	105	105	105	100	105	125	mW
DC Forward Current	25	30	30	30	25	30	mA
Peak Forward Current [1]	150	150	150	150	150	150	mA
Reverse Voltage	5	5	5	5	5	5	V
Operating/Storage Temperature	-40°C To +85°C						

Note:
1. 1/10 Duty Cycle, 0.1ms Pulse Width.

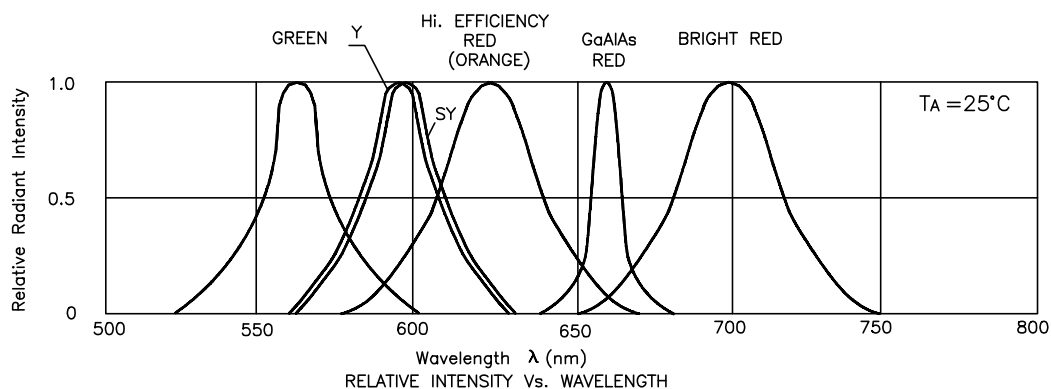

Bright Red KPA-3010HD, KPA-3010HC, KPA-3010HT

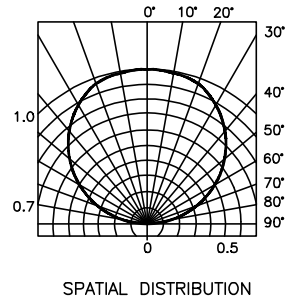
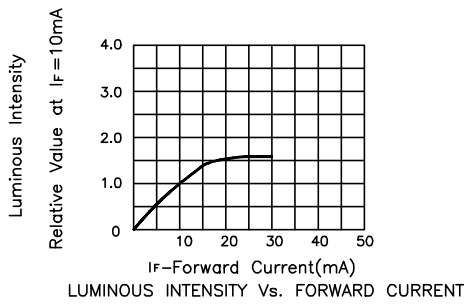
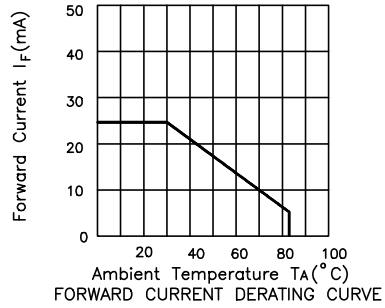
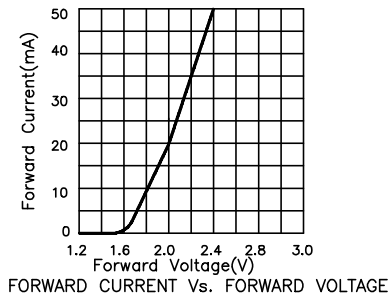

High Efficiency Red KPA-3010ID, KPA-3010EC, KPA-3010IT

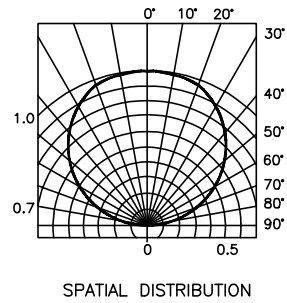
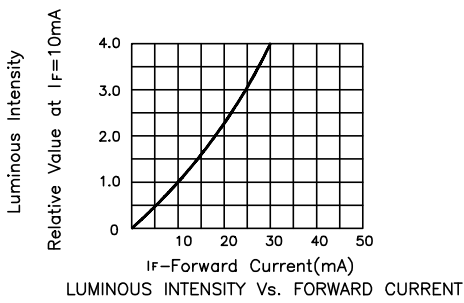
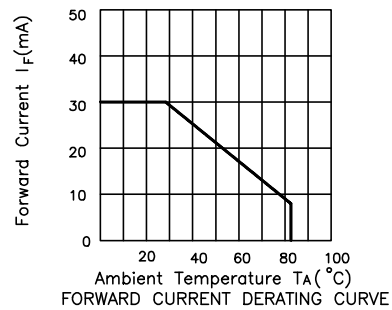
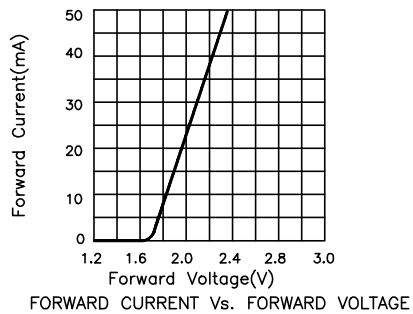

Yellow KPA-3010YD, KPA-3010YC, KPA-3010YT

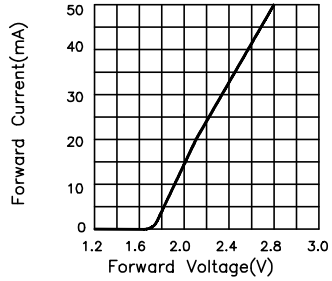

FORWARD CURRENT vs. FORWARD VOLTAGE

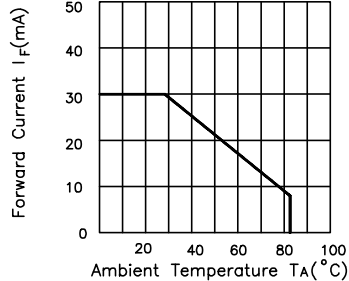

FORWARD CURRENT DERATING CURVE

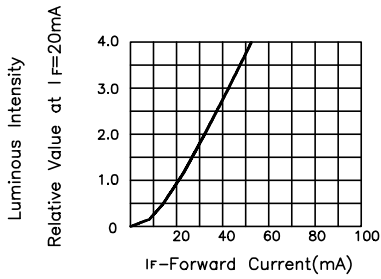

I_F -Forward Current(mA)

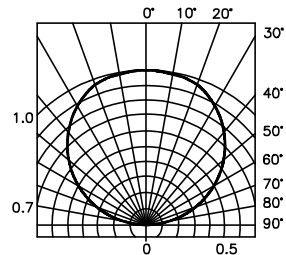

SPATIAL DISTRIBUTION

Super Bright Red KPA-3010SRD, KPA-3010SRC, KPA-3010SRT

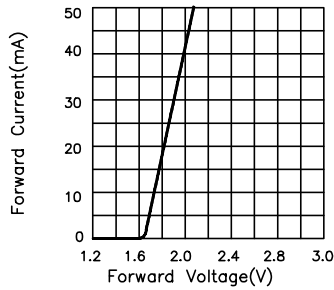

FORWARD CURRENT vs. FORWARD VOLTAGE

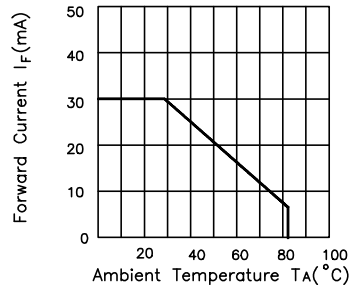

FORWARD CURRENT DERATING CURVE

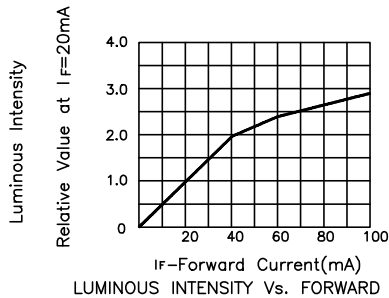

LUMINOUS INTENSITY vs. FORWARD CURRENT

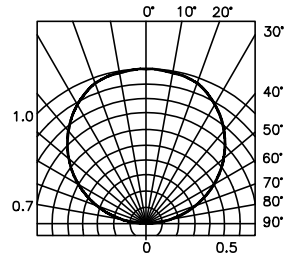

SPATIAL DISTRIBUTION

Super Bright Green KPA-3010SGD, KPA-3010SGC, KPA-3010SGT

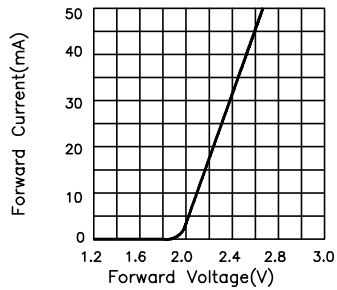

FORWARD CURRENT Vs. FORWARD VOLTAGE

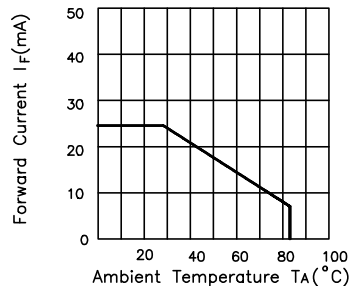

FORWARD CURRENT DERATING CURVE

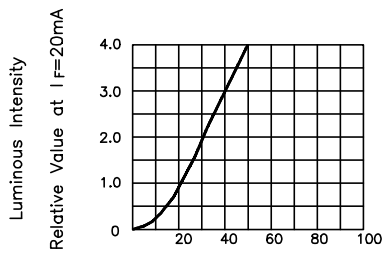

LUMINOUS INTENSITY Vs. FORWARD CURRENT

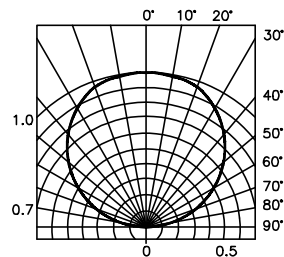

SPATIAL DISTRIBUTION

Super Bright Yellow KPA-3010SYD, KPA-3010SYC, KPA-3010SYT

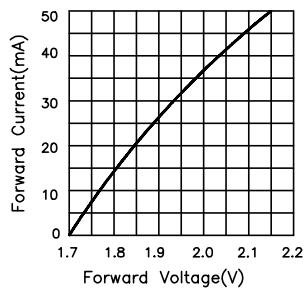

FORWARD CURRENT Vs. FORWARD VOLTAGE

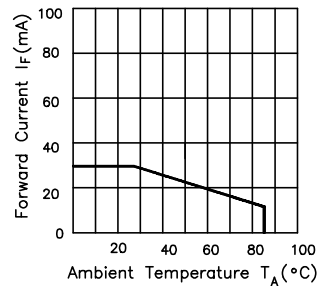

FORWARD CURRENT DERATING CURVE

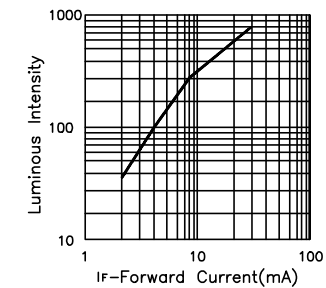

LUMINOUS INTENSITY Vs. FORWARD CURRENT

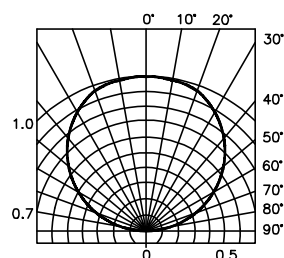

SPATIAL DISTRIBUTION

KPA-3010 Series SMT Reflow Soldering Instructions

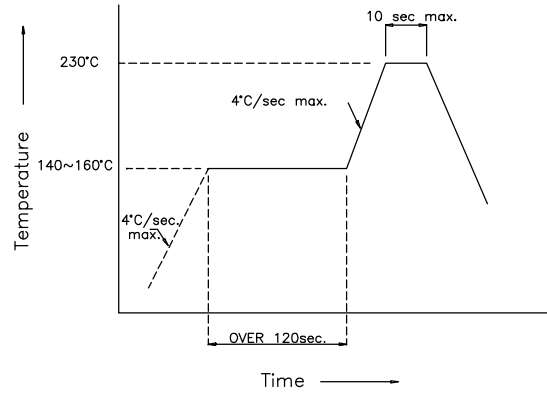

KPA-3010 Series Recommended Soldering Pattern

FOR REFLOW SOLDERING

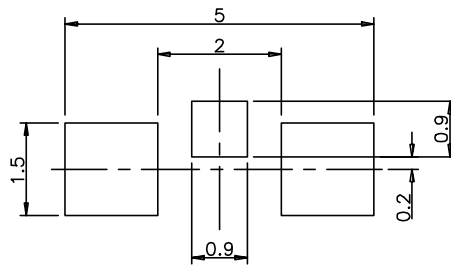

(Units : mm)

KPA-3010 Series Tape Specifications

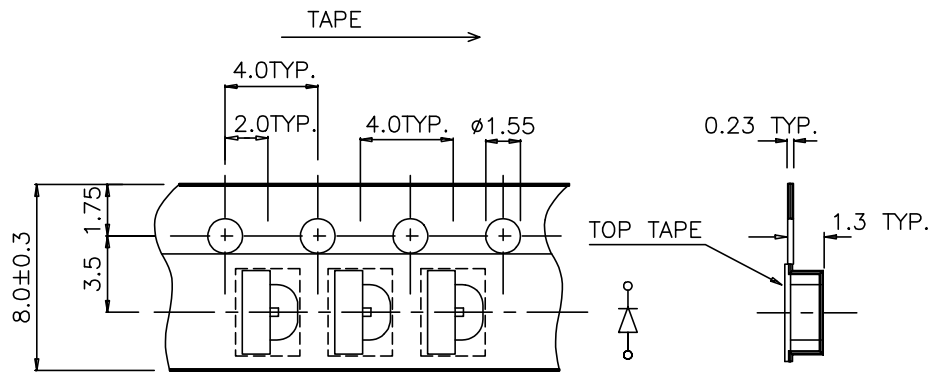

* SR type polarity is opposite

This datasheet has been downloaded from:

www.DatasheetCatalog.com

Datasheets for electronic components.

X-ON Electronics

Largest Supplier of Electrical and Electronic Components

Click to view similar products for [Standard LEDs - SMD category](#):

Click to view products by [Kingbright manufacturer](#):

Other Similar products are found below :

[LTST-C19GD2WT](#) [LTST-N683GBEW](#) [597-3006-607F](#) [597-3403-607F](#) [LTW-K140SZR40](#) [LTW-M140ZVS](#) [598-8110-100F](#) [598-8170-100F](#)
[598-8610-202F](#) [7012X7](#) [AAAF5060QBFSEEZGS](#) [12-22SURSYGC/S530-A3/E2/TR8](#) [1383SURT/S530-A3/TR1\(R\)](#) [APT1608QGW](#)
[EASV1803BA0](#) [HT-F104TW-5860](#) [SML310BATT86](#) [SML-512VWT86A](#) [SML-LX0606SISUGC/A](#) [SML-LXL1307SRC-TR](#) [SML-](#)
[LXR851SIUPGUBC](#) [LT1ED53A](#) [17-21/G6C-FM1N2B/3T](#) [FAT801-S](#) [SSL-LXA227IC-TR31A](#) [AM27ZGC03](#) [APB3025SGNC](#)
[APHK1608VGCA](#) [APT2012QGW](#) [CLMVC-FKA-CA1E1L81BB7C3C3](#) [CLYBA-FKA-CFHHL9BBB7A363](#) [CMD11504UR](#) [LTW-](#)
[020ZDCG](#) [LTW-21TS5](#) [LTW-K140SZR30](#) [HSMY-C177](#) [HT-121UYG-4739](#) [UYGT801-S](#) [KVH1C100MF6R](#) [42-21SYGC/S530-E1/TR8](#)
[YGFR411-H](#) [597-2311-402F](#) [5973212407NF](#) [597-3302-607F](#) [597-5202-407F](#) [598-8330-117F](#) [SAW8WA2A-L35M40-CA](#) [SML013WBDW1](#)
[SML522BUWT86](#) [SML-LX0402IC-TR](#)