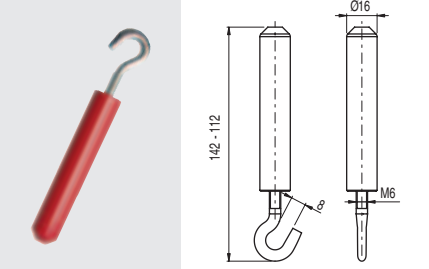
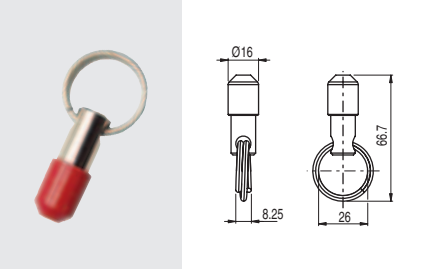
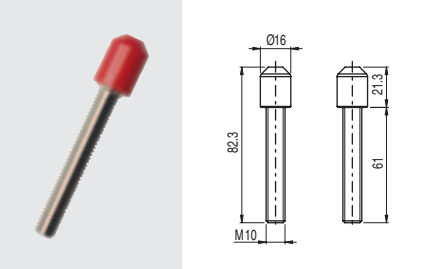

Rope installation accessories, FAST line

Article	Description	Article	Description	Article	Description
VF AF-TR5	Adjustable stay bolt	VF AF-MR5	End clamp	VF AF-TR8	Stay bolt

Pulleys

Article	Description	Article	Description
VF AF-CA5	Pulley	VF AF-CA10	Angular pulley

Safety spring

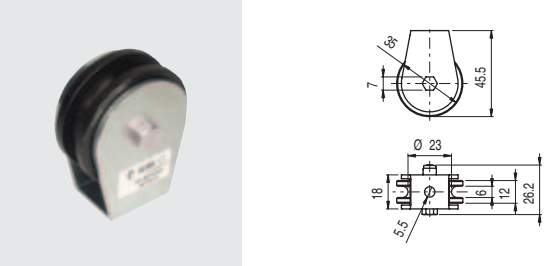
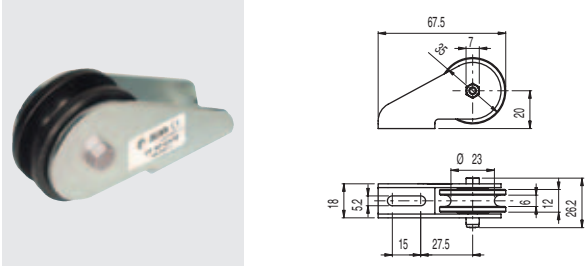
Article	Description	Article	Description
VF AF-ME78	Safety spring	VF AF-ME80	Safety spring



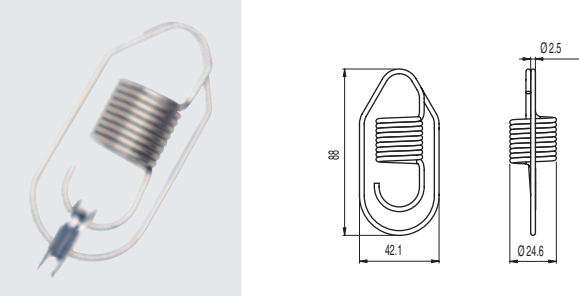
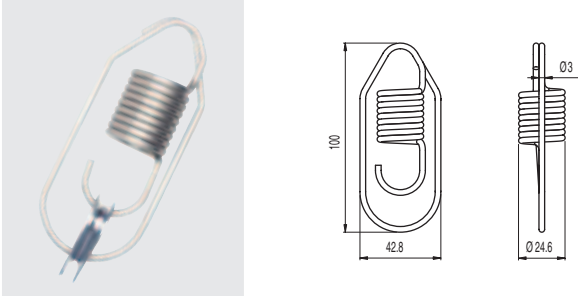

For longitudinal heads only. Example FD 1878

For transversal heads only. Example FD 1883

Light indicator

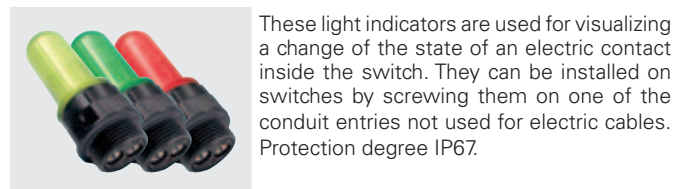
Article	Description
VF ILI024GP	Yellow, 24 VAC/dc
VF ILI024RP	Red, 24 VAC/dc
VF ILI024VP	Green, 24 VAC/dc
VF ILI024TP	White, 24 VAC/dc
VF ILX000GP	Yellow, without lamp
VF ILX000RP	Red, without lamp
VF ILX000VP	Green, without lamp
VF ILX000TP	Transparent, without lamp



Function indicator

Article	Description
VF AF-IF1GR01	text "ARRESTO EMERGENZA"
VF AF-IF1GR02	text "EMERGENCY STOP"
VF AF-IF1GR03	text "STOP"
VF AF-IF1GR04	text "NOT - AUS"
VF AF-IF1GR05	text "ARRET D'URGENCE"
VF AF-IF1GR06	text "PARADA DE EMERGENCIA"
VF AF-IF1GR07	text "NODSTOP"
VF AF-IF1GR08	text "ⓈSTOPⓈ"

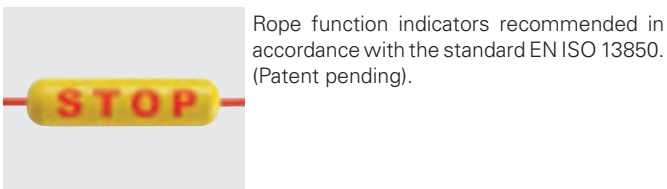



Rope and other accessories

Article	Description	Weight(Kg)
VF F05-100	100 m rope	5,1
VF F05-035	35 m rope	1,8
VF F05-020	20 m rope	1,0
VF F05-010	10 m rope	0,5



Ø 5 mm zinc-plated steel rope roll, coated with red plastic material.

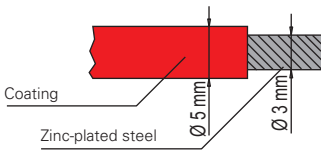

The rope has been selected for long-term resistance against negligence and atmospheric agents.

Article	Description
VF F05-400	Rope



400 m board roll, zinc-plated steel rope Ø 5 mm, coated with red plastic material.

Weight 20,5 Kg.

Article	Description
VF F05-500B	Rope



500 m board roll, zinc-plated steel rope Ø 5 mm, coated with white plastic material.

Weight 25,6 Kg.

Article	Description
VF SB400	Rope dispenser



Support stand for board roll, it makes the uncoiling easy and practical without kinking the rope. Provided with a handle, it allows an easy transport of the coil without damage.

Article	Description
VF SFP2	Ceiling fixing plate



Metal fixing plate, designed to fix rope switches on ceiling. The plate is provided with many fixing holes suitable for all switches series. It is supplied without screws.

Rope installation accessories kits, FAST line

Practical installation kits containing stay bolts and rope in the same package.



Article	Kit content
VF AF-KT10M0	1x VF AF-TR5 1x VF AF-MR5 1x VF F05-010
VF AF-KT20M0	1x VF AF-TR5 1x VF AF-MR5 1x VF F05-020
VF AF-KT35M0	1x VF AF-TR5 1x VF AF-MR5 1x VF F05-035

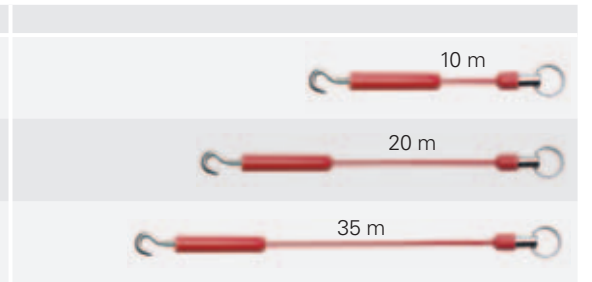

Article	Kit content
VF AF-KM10R0	1x VF AF-MR5 1x VF AF-TR8 1x VF F05-010
VF AF-KM20R0	1x VF AF-MR5 1x VF AF-TR8 1x VF F05-020
VF AF-KM35R0	1x VF AF-MR5 1x VF AF-TR8 1x VF F05-035

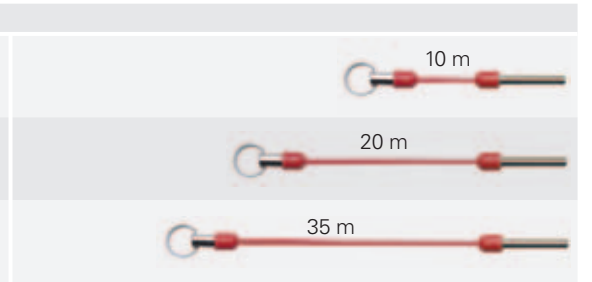

Article	Kit content
VF AF-KT10M7	1x VF AF-TR5 1x VF AF-MR5 1x VF F05-010 1x VF AF-ME78
VF AF-KT20M8	1x VF AF-TR5 1x VF AF-MR5 1x VF F05-020 1x VF AF-ME80
VF AF-KT35M8	1x VF AF-TR5 1x VF AF-MR5 1x VF F05-035 1x VF AF-ME80

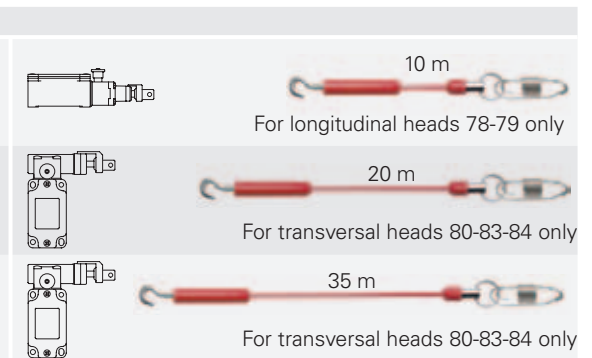

Items with code on the green background are available in stock

Combinations examples

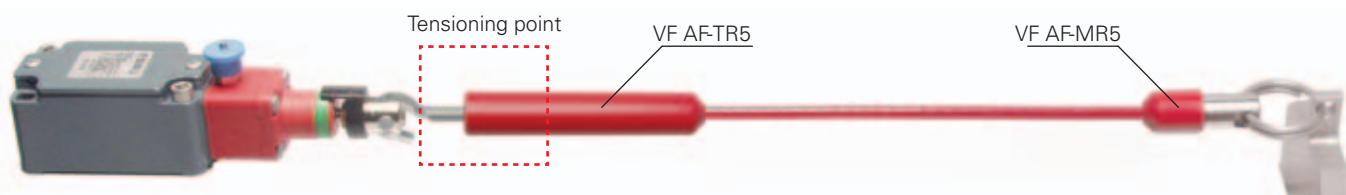

This combination of accessories is suitable for medium rope lengths, where the two rope ends are far away from each other.

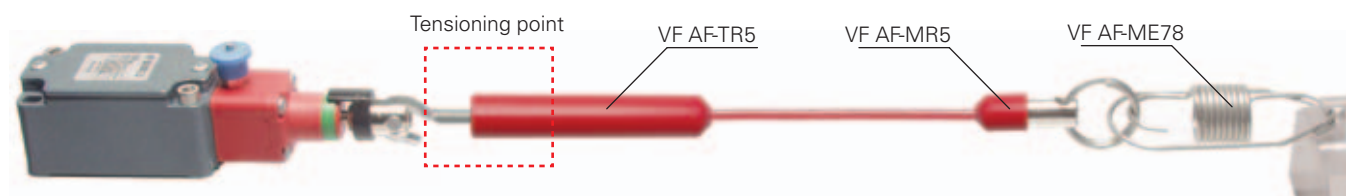

This combination of accessories is suitable for medium-high rope lengths (thanks to VF AF-ME78 safety spring) and where the two rope ends are far away from each other.



This combination of accessories is suitable for medium rope lengths or where the two rope ends are close to each other.

A Adjustable stay bolt VF AF-TR5 installation

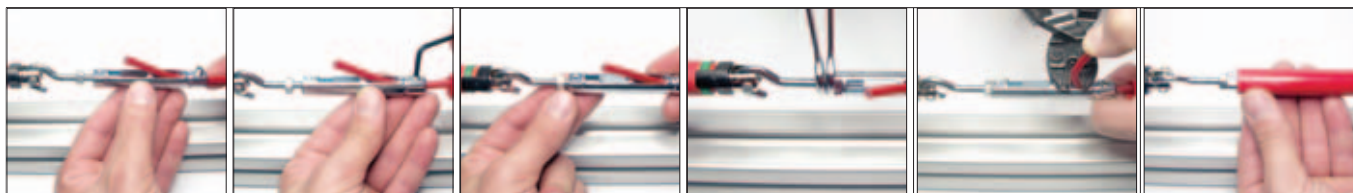

Rope insertion

Rope fixing

Rope tightening

Stay bolt blocking

Cutting of the rope in excess

Stay bolt covering

B Stay bolt VF AF-TR8 installation

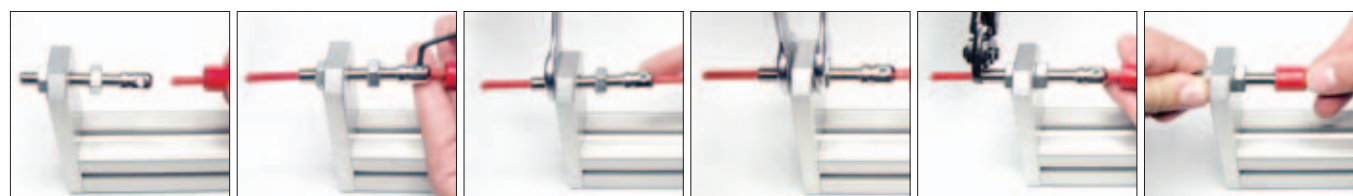

Rope insertion

Rope fixing

Rope tightening

Stay bolt blocking

Cutting of the rope in excess

Stay bolt covering

C End clamp VF AF-MR5 installation



Rope insertion

Rope fixing

Stay bolt covering



Application example: possibility of emergency stop along the whole perimeter of the machine.
Rope supported by angular pulleys.



Angular pulley
 Article: VF AF-CA10

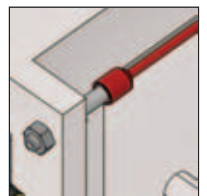

Stay bolt
 Article: VF AF-TR8

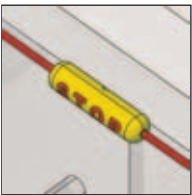

Function indicator
 Article: VF AF -IF1GR03

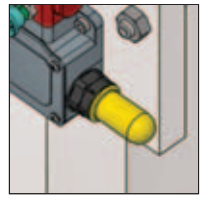

Light indicator
 Article: VF ILI024GP

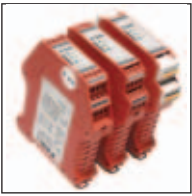

Safety module
 Example: CS AR-20V024

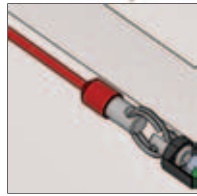

End clamp
 Article: VF AF-MR5

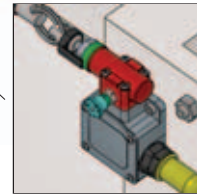

Rope safety switches
 Article: FL 1883

Application example: possibility of emergency stop along the frontal section of the machine.

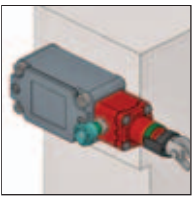
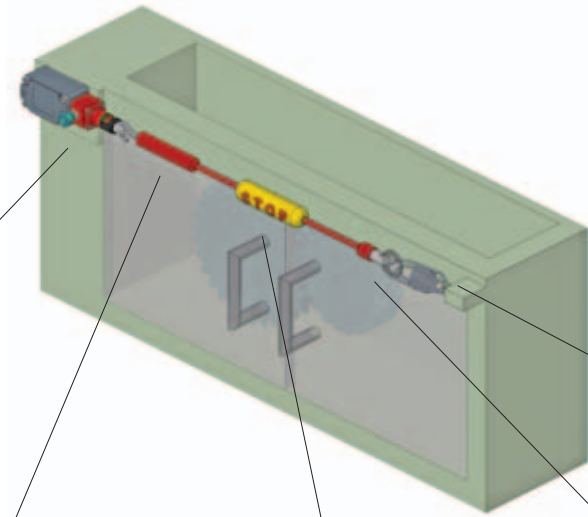

Rope safety switches
 Article: FD 1878



Adjustable stay bolt
 Article: VF AF-TR5

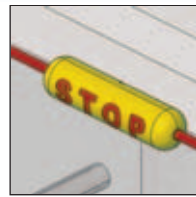

Function indicator
 Article: VF AF -IF1GR03

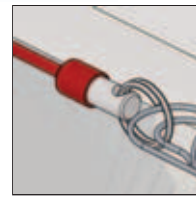

End clamp
 Article: VF AF-MR5

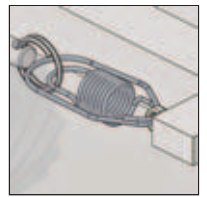

Safety spring
 Article: VF AF-ME78

Any information or application example, included the connection diagrams, described in this document are to be intended as purely descriptive. The choice and application of the products in conformity with the Standards, in order to avoid damages to persons or goods, is under the responsibility of the user.

- 1
- 1A
- 1B
- 2
- 2A
- 2B
- 2C
- 2D
- 2E
- 3
- 3A
- 3B
- 3C
- 4
- 4A
- 4B
- 4C
- 4D
- 4E
- 4F
- 4G
- 4H
- 5
- 6

X-ON Electronics

Largest Supplier of Electrical and Electronic Components

Click to view similar products for [Emergency Stop Switches / E-Stop Switches](#) category:

Click to view products by [Pizzato](#) manufacturer:

Other Similar products are found below :

[84-5021.2B40](#) [84-6830.0020](#) [A01ESSP8](#) [A22EL-M-24A-11B](#) [AVN302N-R](#) [A165E-S-01\(STOP\)](#) [AYLD2212602SN-R-TK962](#)
[AVLD39911N-R-24V](#) [A22Z-EG22](#) [A165E-SY](#) [3100.0110Y](#) [3050.1302Y](#) [3SE2243-0XX40](#) [3SK1111-2AB30](#) [3SK1211-1BB40](#) [44-710](#) [84-](#)
[6841.2B20](#) [84-6830.0040](#) [H3141AAKAA](#) [A165E-R-24D-01](#) [E3102AAAAB](#) [A22E-M-03](#) [ZA2BV05](#) [A22EL-M-T2-01](#) [951FY000-WO](#)
[ER6022-022N](#) [952+2000-00](#) [ES3S51653](#) [601+0000-OP](#) [E3101AAAAB](#) [84-5130.0040](#) [CS AR-05V024](#) [CS AR-22V024](#) [DS AE1VA](#) [DS](#)
[KB2A](#) [DS KB3A](#) [HE2G-21SHE-L-K](#) [HE6B-M211Y](#) [774191](#) [774316](#) [777760](#) [R1.100.0129.0 SMA0129- NO/NO](#) [R1.188.0640.0 SNV](#)
[4063KL-A](#) [R1.188.1810.0 SNA 4043K-A](#) [R1.188.1840.0 SNA 4043K-A](#) [SR BD40ALK-B02F](#) [AVLW39911D-R-120V](#) [AYD311NUG](#)
[AVLD32211DNUR](#) [84-5040.0020.0049](#)