

Rope installation accessories, FAST line

Article	Description
VF AF-TR5	Adjustable stay bolt

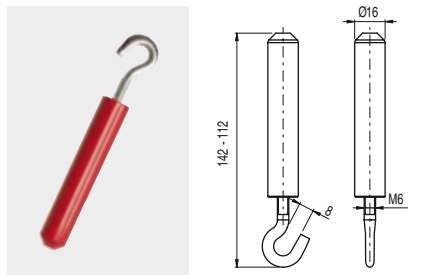

Article	Description
VF AF-MR5	End clamp

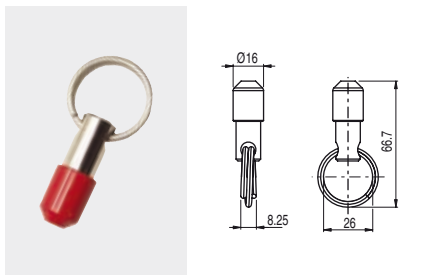

Article	Description
VF AF-TR8	Stay bolt

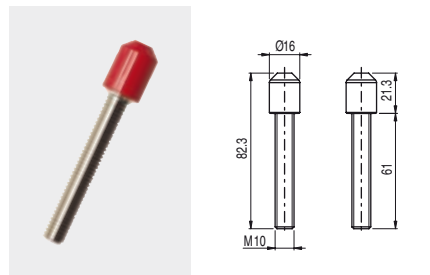

Pulleys

Article	Description
VF AF-CA5	Pulley

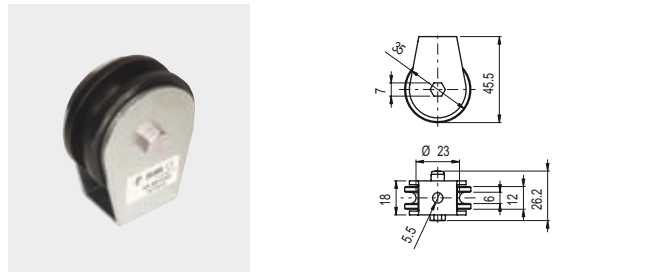

Article	Description
VF AF-CA10	Angular pulley

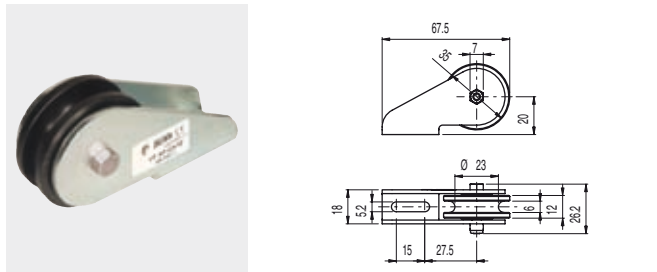

Safety spring

Article	Description
VF AF-ME78	Safety spring

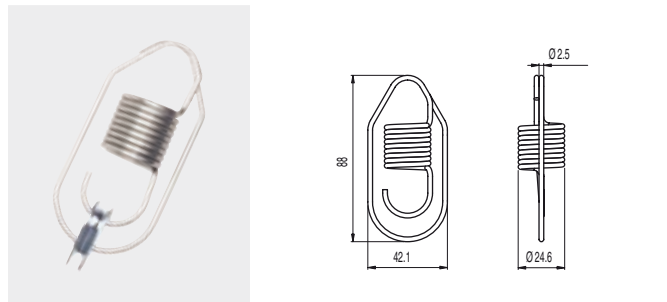

For longitudinal heads only. Example FD 1878

Article	Description
VF AF-ME80	Safety spring

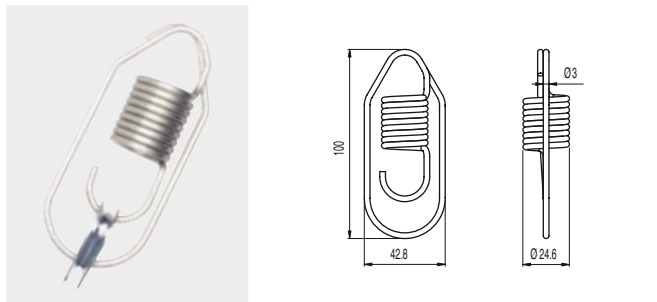

For transversal heads only. Example FD 1883

Light indicator

Article	Description
VF ILI024GP	Yellow, 24 VAC/DC
VF ILI024RP	Red, 24 VAC/DC
VF ILI024VP	Green, 24 VAC/DC
VF ILI024TP	White, 24 VAC/DC
VF ILX000GP	Yellow, without lamp
VF ILX000RP	Red, without lamp
VF ILX000VP	Green, without lamp
VF ILX000TP	Transparent, without lamp



These light indicators are used for visualizing a change of the state of an electric contact inside the switch. They can be installed on switches by screwing them on one of the conduit entries not used for electric cables. Protection degree IP67

Function indicator

Article	Description
VF AF-IF1GR01	text "ARRESTO EMERGENZA"
VF AF-IF1GR02	text "EMERGENCY STOP"
VF AF-IF1GR03	text "STOP"
VF AF-IF1GR04	text "NOT - AUS"
VF AF-IF1GR05	text "ARRET D'URGENCE"
VF AF-IF1GR06	text "PARADA DE EMERGENCIA"



Rope function indicators recommended in accordance with the standard EN ISO 13850. (Patent pending).

Items with code on the green background are available in stock

Rope and other accessories

Article	Description	Weight(Kg)
VF F05-100	100 m rope	5,1
VF F05-035	35 m rope	1,8
VF F05-020	20 m rope	1,0
VF F05-010	10 m rope	0,5



Ø 5 mm zinc-plated steel rope roll, coated with red plastic material.

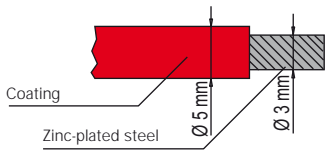

The rope has been selected for long-term resistance against negligence and atmospheric agents.

Article	Description
VF F05-400	Rope



400 m board roll, zinc-plated steel rope Ø 5 mm, coated with red plastic material.

Weight 20,5 Kg.

Article	Description
VF F05-500B	Rope



500 m board roll, zinc-plated steel rope Ø 5 mm, coated with white plastic material.

Weight 25,6 Kg.

Article	Description
VF SB400	Rope dispenser



Support stand for board roll, it makes the uncoiling easy and practical without kinking the rope. Provided with a handle, it allows an easy transport of the coil without damage.

Article	Description
VF SFP2	Ceiling fixing plate





Metal fixing plate, designed to fix rope switches on ceiling. The plate is provided with many fixing holes suitable for all switches series. It is supplied without screws.

Rope installation accessories kits, FAST line

Practical installation kits containing stay bolts and rope in the same package.



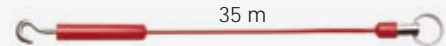

Article	Kit content	
VF AF-KT10M0	1x VF AF-TR5 1x VF AF-MR5 1x VF F05-010	 10 m
VF AF-KT20M0	1x VF AF-TR5 1x VF AF-MR5 1x VF F05-020	 20 m
VF AF-KT35M0	1x VF AF-TR5 1x VF AF-MR5 1x VF F05-035	 35 m

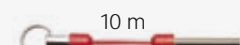
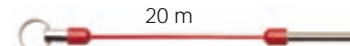
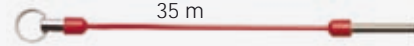

Article	Kit content	
VF AF-KM10R0	1x VF AF-MR5 1x VF AF-TR8 1x VF F05-010	 10 m
VF AF-KM20R0	1x VF AF-MR5 1x VF AF-TR8 1x VF F05-020	 20 m
VF AF-KM35R0	1x VF AF-MR5 1x VF AF-TR8 1x VF F05-035	 35 m

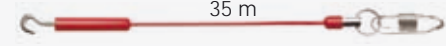

Article	Kit content	
VF AF-KT10M7	1x VF AF-TR5 1x VF AF-MR5 1x VF F05-010 1x VF AF-ME78	 10 m For longitudinal heads 78-79 only
VF AF-KT20M8	1x VF AF-TR5 1x VF AF-MR5 1x VF F05-020 1x VF AF-ME80	 20 m For transversal heads 80-83-84 only
VF AF-KT35M8	1x VF AF-TR5 1x VF AF-MR5 1x VF F05-035 1x VF AF-ME80	 35 m For transversal heads 80-83-84 only

Items with code on the green background are available in stock

Combinations examples

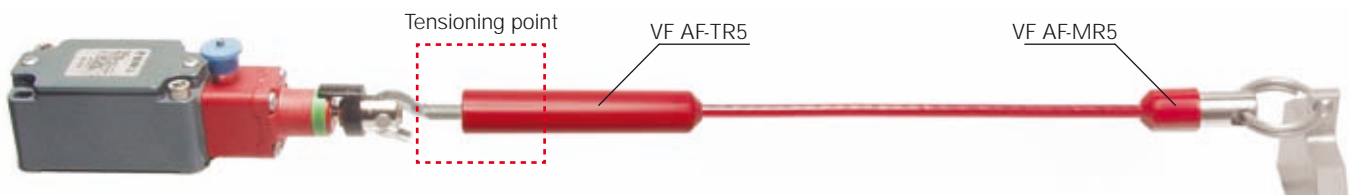

This combination of accessories is suitable for medium rope lengths, where the two rope ends are far away from each other.

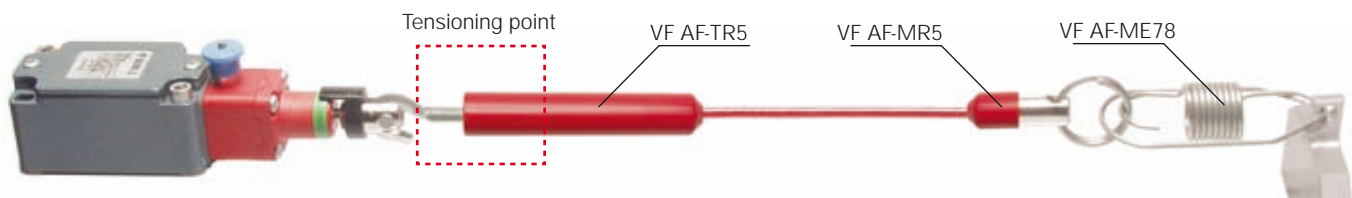

This combination of accessories is suitable for medium-high rope lengths (thanks to VF AF-ME78 safety spring) and where the two rope ends are far away from each other.



This combination of accessories is suitable for medium rope lengths or where the two rope ends are close to each other.

A Adjustable stay bolt VF AF-TR5 installation

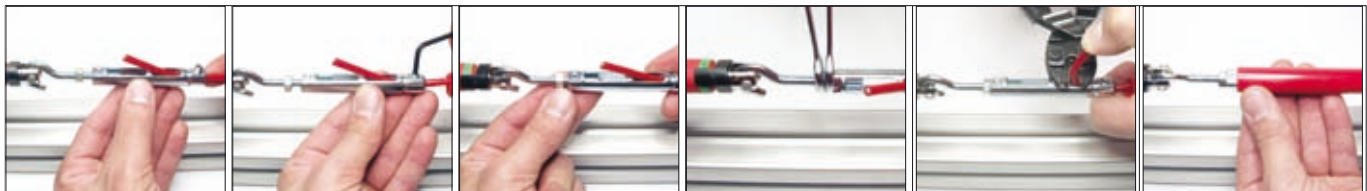

Rope insertion

Rope fixing

Rope tightening

Stay bolt blocking

Cutting of the rope in excess

Stay bolt covering

B Stay bolt VF AF-TR8 installation

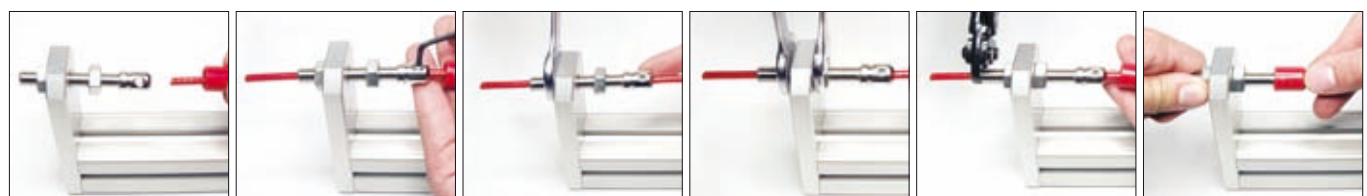

Rope insertion

Rope fixing

Rope tightening

Stay bolt blocking

Cutting of the rope in excess

Stay bolt covering

C End clamp VF AF-MR5 installation



Rope insertion

Rope fixing

Stay bolt covering

**Application example: possibility of emergency stop along the whole perimeter of the machine.
Rope supported by angular pulleys.**

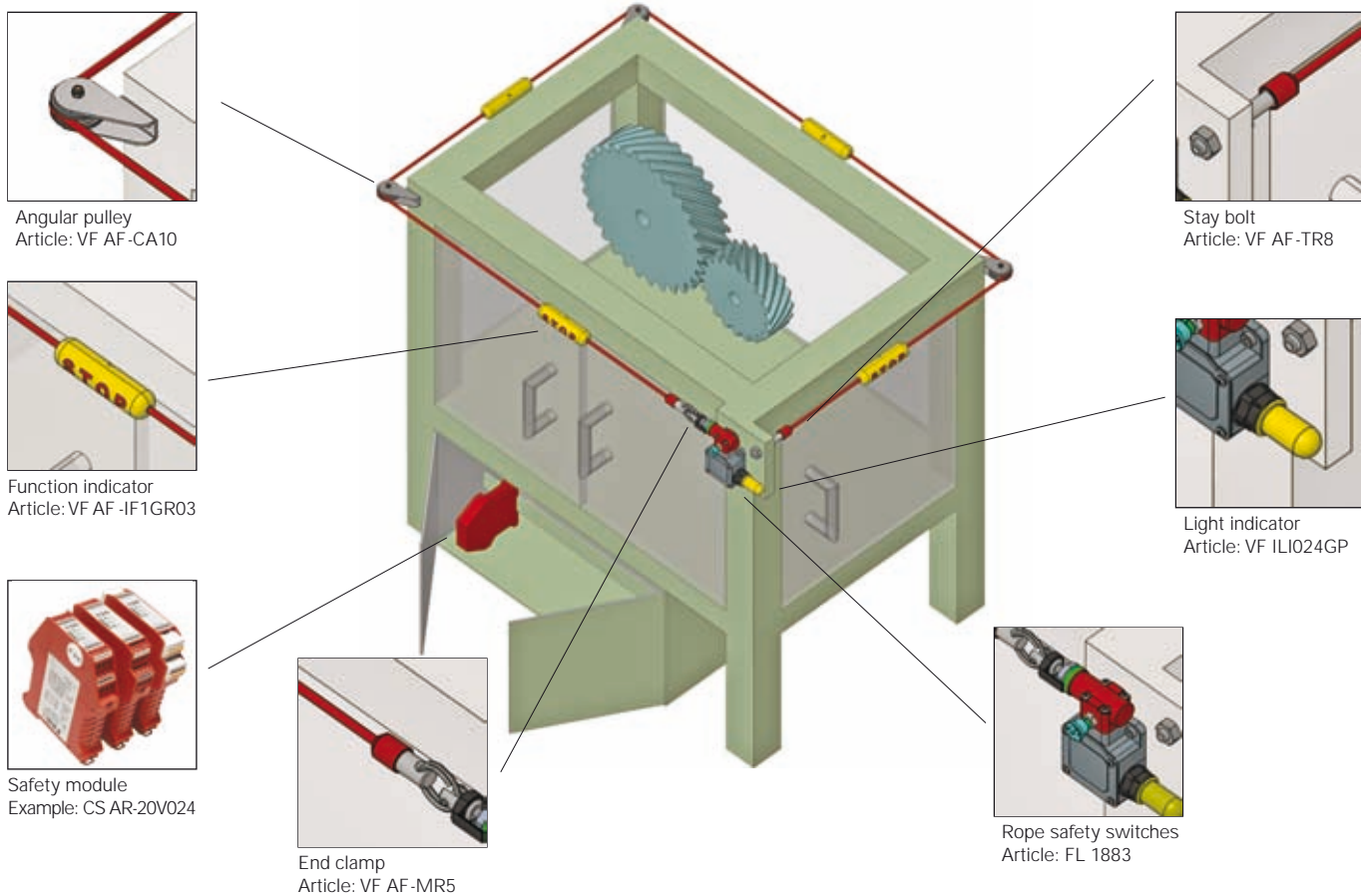

Application example: possibility of emergency stop along the frontal section of the machine.

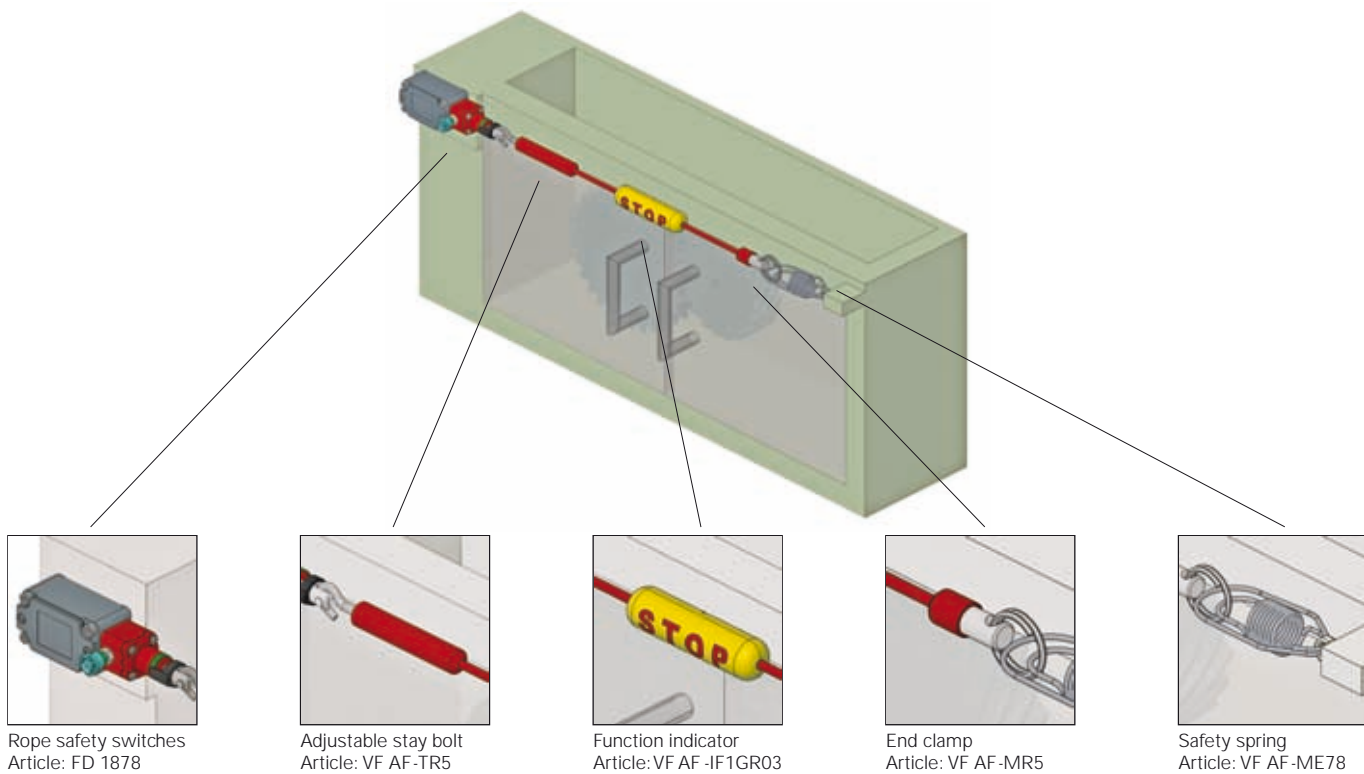

Any information or application example, included the connection diagrams, described in this document are to be intended as purely descriptive. The choice and application of the products in conformity with the Standards, in order to avoid damages to persons or goods, is under the responsibility of the user.

X-ON Electronics

Largest Supplier of Electrical and Electronic Components

Click to view similar products for [Emergency Stop Switches / E-Stop Switches](#) category:

Click to view products by [Pizzato](#) manufacturer:

Other Similar products are found below :

[84-5021.2B40](#) [84-6830.0020](#) [A01ESSP8](#) [A22EL-M-24A-11B](#) [AVN302N-R](#) [A165E-S-01\(STOP\)](#) [AYLD2212602SN-R-TK962](#)
[AVLD39911N-R-24V](#) [A22Z-EG22](#) [A165E-SY](#) [3100.0110Y](#) [3050.1302Y](#) [3SE2243-0XX40](#) [3SK1111-2AB30](#) [3SK1211-1BB40](#) [44-710](#) [84-](#)
[6841.2B20](#) [84-6830.0040](#) [H3141AAKAA](#) [A165E-R-24D-01](#) [E3102AAAAB](#) [A22E-M-03](#) [ZA2BV05](#) [A22EL-M-T2-01](#) [951FY000-WO](#)
[ER6022-022N](#) [952+2000-00](#) [ES3S51653](#) [601+0000-OP](#) [E3101AAAAB](#) [84-5130.0040](#) [CS AR-05V024](#) [CS AR-22V024](#) [DS AE1VA](#) [DS](#)
[KB2A](#) [DS KB3A](#) [HE2G-21SHE-L-K](#) [HE6B-M211Y](#) [774191](#) [774316](#) [777760](#) [R1.100.0129.0 SMA0129- NO/NO](#) [R1.188.0640.0 SNV](#)
[4063KL-A](#) [R1.188.1810.0 SNA 4043K-A](#) [R1.188.1840.0 SNA 4043K-A](#) [SR BD40ALK-B02F](#) [AVLW39911D-R-120V](#) [AYD311NUG](#)
[AVLD32211DNUR](#) [84-5040.0020.0049](#)