



Up to Category 4, EN 954-1 PNOZ X2



Safety relay for monitoring E-STOP pushbuttons and safety gates.

Approvals

	PNOZ X2
	◆
	◆
	◆

Unit features

- ▶ Positive-guided relay outputs:
 - 2 safety contacts (N/O), instantaneous
- ▶ Connection options for:
 - E-STOP pushbutton
 - Safety gate limit switch
 - Reset button
- ▶ LED indicator for:
 - Switch status channel 1/2
 - Supply voltage
- ▶ See order reference for unit types

- ▶ The safety function remains effective in the case of a component failure.
- ▶ The correct opening and closing of the safety function relays is tested automatically in each on-off cycle.
- ▶ The unit has an electronic fuse.

Unit description

The safety relay meets the requirements of EN 60204-1 and IEC 60204-1 and may be used in applications with

- ▶ E-STOP pushbuttons
- ▶ Safety gates

Safety features

The relay conforms to the following safety criteria:

- ▶ The circuit is redundant with built-in self-monitoring.

Block diagram

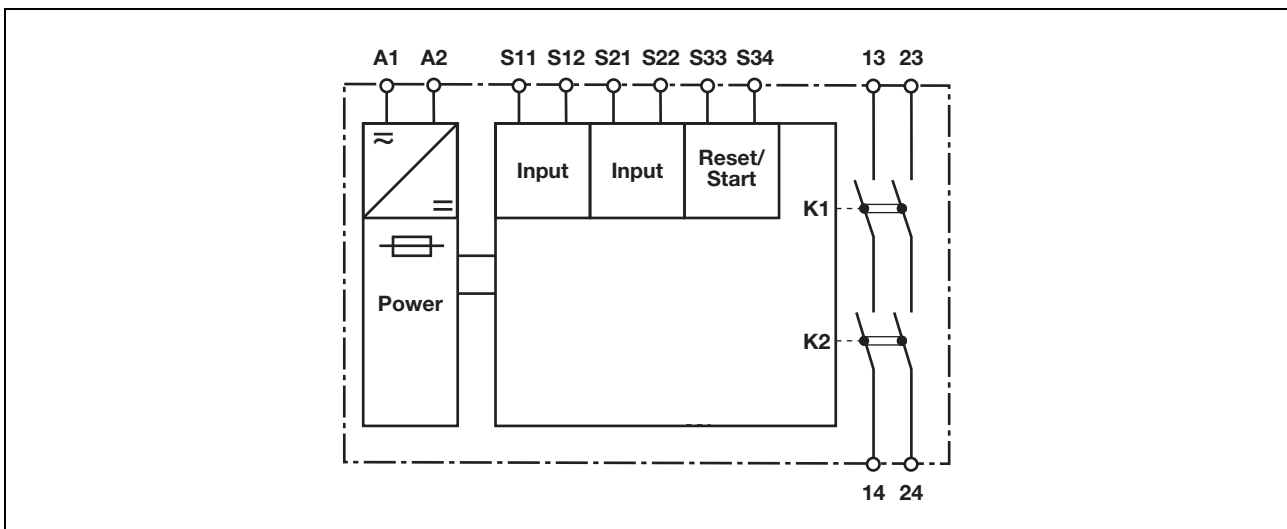

Up to Category 4, EN 954-1 PNOZ X2

Function description

- ▶ Single-channel operation: no redundancy in the input circuit, earth faults in the reset circuit are detected.
- ▶ Dual-channel operation with detection of shorts across contacts: redundant input circuit, detects
 - earth faults in the reset and input circuit,
 - short circuits in the input circuit and, with a monitored reset, in the reset circuit too,
 - shorts between contacts in the input circuit.
- ▶ Monitored reset: Unit is active once the input circuit is closed and once the reset circuit is closed after the waiting period has elapsed (see technical details).
- ▶ Increase in the number of available contacts by connecting contact expander modules or external contactors/relays.

Timing diagram

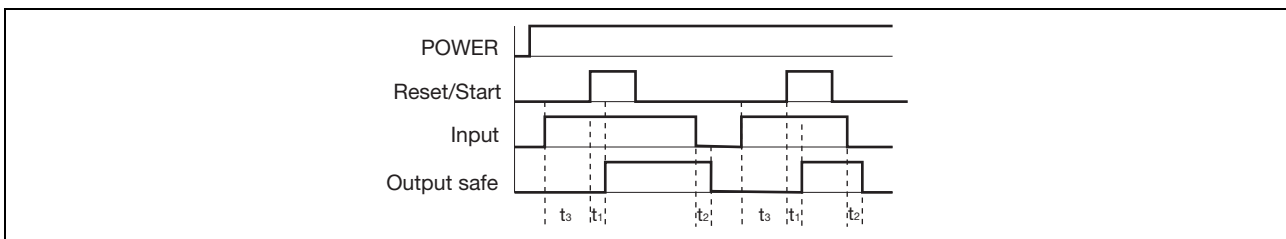

Key

- ▶ Power: Supply voltage
- ▶ Reset/start: Reset circuit S33-S34
- ▶ Input: Input circuits S11-S12, S21-S22
- ▶ Output safe: Safety contacts 13-14, 23-24
- ▶ t_3 : Waiting period
- ▶ t_1 : Switch-on delay
- ▶ t_2 : Delay-on de-energisation

Wiring

Please note:

- ▶ Information given in the “Technical details” must be followed.
- ▶ Outputs 13-14, 23-24 are safety contacts.
- ▶ To prevent contact welding, a fuse should be connected before the output contacts (see technical details).
- ▶ Calculation of the max. cable runs I_{max} in the input circuit:

$$I_{max} = \frac{R_{lmax}}{R_l / km}$$

R_{lmax} = max. overall cable resistance (see technical details)

R_l / km = cable resistance/km

- ▶ Use copper wire that can withstand 60/75 °C.
- ▶ Sufficient fuse protection must be provided on all output contacts with capacitive and inductive loads.

Up to Category 4, EN 954-1 PNOZ X2

Preparing for operation

► Supply voltage

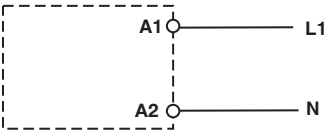
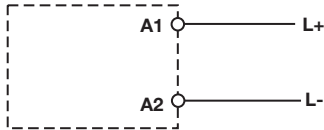
Supply voltage	AC	DC
		

► Input circuit

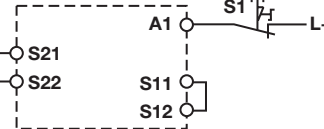
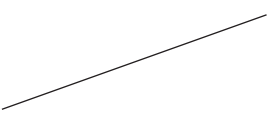
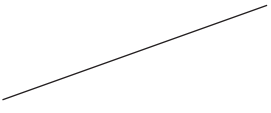
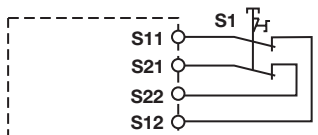
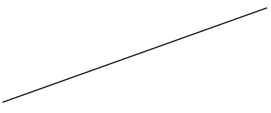
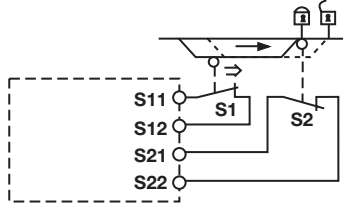
Input circuit	Single-channel	Dual-channel
E-STOP without detection of shorts across contacts		
E-STOP with detection of shorts across contacts		
Safety gate with detection of shorts across contacts		

► Reset circuit

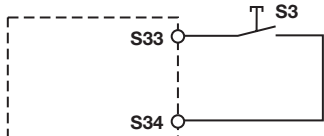
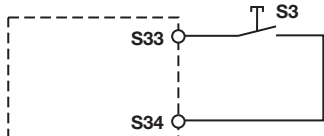

Reset circuit	E-STOP wiring (single-channel) Safety gate (single-channel)	E-STOP wiring (dual-channel) Safety gate (dual-channel)
Monitored reset		

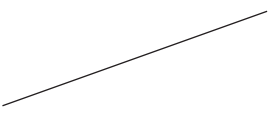
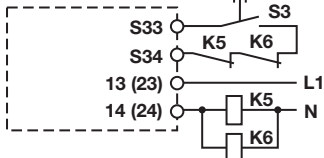
► Feedback loop

Feedback loop	Automatic reset	Monitored reset
Contacts from external contactors		

Up to Category 4, EN 954-1 PNOZ X2

► Key

S1/S2	E-STOP pushbutton/ safety gate switch
S3	Reset button
	Switch operated
	Gate open
	Gate closed

Up to Category 4, EN 954-1 PNOZ X2

Terminal configuration

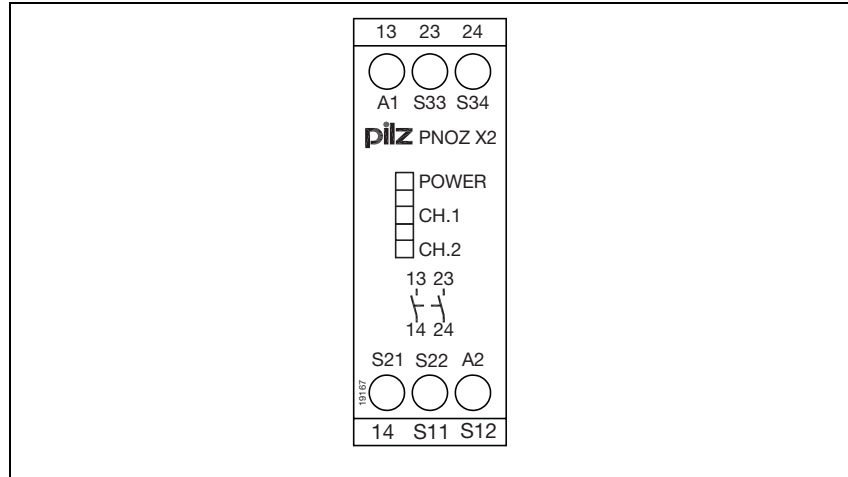

Installation

- ▶ The safety relay should be installed in a control cabinet with a protection type of at least IP54.
- ▶ Use the notch on the rear of the unit to attach it to a DIN rail.
- ▶ Ensure the unit is mounted securely on a vertical DIN rail (35 mm) by using a fixing element (e.g. retaining bracket or an end angle).

Dimensions

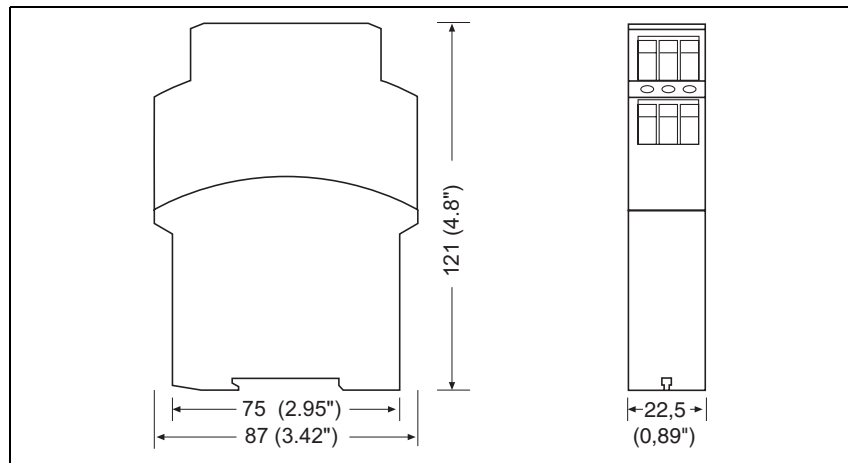

Up to Category 4, EN 954-1 PNOZ X2

Notice

This data sheet is only intended for use during configuration. For installation and operation, please refer to the operating instructions supplied with the unit.

Service life graph

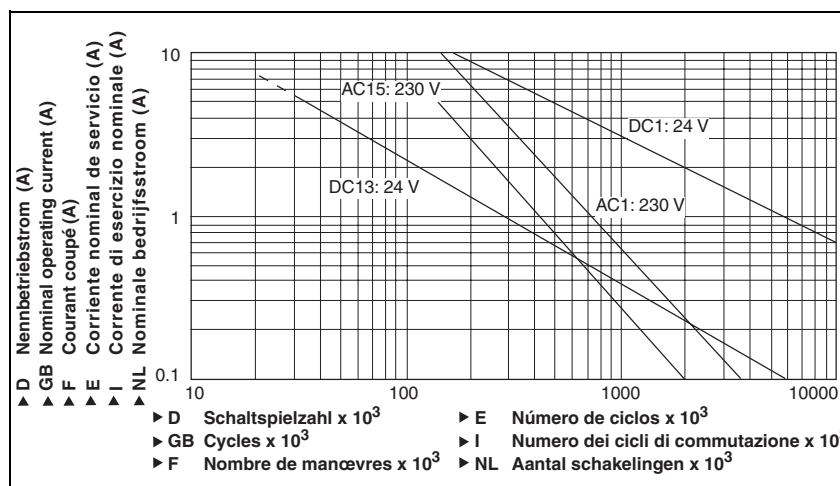

Technical details

Electrical data

Supply voltage	
Supply voltage U _B AC	24 V
Supply voltage U _B DC	24 V
Voltage tolerance	-15% / +10%
Power consumption at U _B AC	4.5 VA
Power consumption at U _B DC	2.0 W
Frequency range AC	50 - 60 Hz
Residual ripple DC	160 %
Voltage and current at input circuit DC: 24.0 V	25 mA
reset circuit DC: 24.0 V	50 mA
feedback loop DC: 24.0 V	50 mA
Output contacts in accordance with EN 954-1 , Category 4	Safety contacts (N/O): 2
Utilisation category in accordance with EN 60947-4-1	
AC1: 240 V	I _{min} : 0.01 A , I _{max} : 6.0 A P: 1500 VA
DC1: 24 V	I _{min} : 0.01 A , I _{max} : 6.0 A P: 150 W
Utilisation category in accordance with EN 60947-5-1	
AC15: 230 V	I _{max} : 5.0 A
DC13: 24 V	I _{max} : 4.0 A
(DC13: 6 cycles/min)	
Contact material	AgSnO2 + 0.2 µm Au
External contact fuse protection in accordance with EN 60947-5-1	
Blow-out fuse, quick	6 A
Blow-out fuse, slow	4 A
Circuit breaker	24 VAC/DC, 4 A , characteristic B/C
Max. overall cable resistance R _{lmax} input circuits, reset circuits	
Single-channel at U _B AC	150 Ohm
Single-channel at U _B DC	150 Ohm
Dual-channel with detect. of shorts across contacts at U _B AC	30 Ohm
Dual-channel with detect. of shorts across contacts at U _B DC	15 Ohm

Up to Category 4, EN 954-1 PNOZ X2

Times	
Switch-on delay	
with monitored reset typ.	38 ms
with monitored reset max.	50 ms
Delay-on de-energisation	
with E-STOP typ.	17 ms
with E-STOP max.	30 ms
after power failure typ.	70 ms
after power failure max.	110 ms
Recovery time at max. switching frequency 1/s	
after E-STOP	50 ms
after power failure	150 ms
Waiting period with a monitored reset	180 ms
Simultaneity, channel 1 and 2	∞
Supply interruption before de-energisation	20 ms
Environmental data	
EMC	EN 60947-5-1, EN 61000-6-2
Vibration in accordance with EN 60068-2-6	
Frequency:	10 - 55 Hz
Amplitude:	0.35 mm
Climatic suitability	EN 60068-2-78
Airgap creepage	EN 60947-1
Ambient temperature	-10 - 55 °C
Storage temperature	-40 - 85 °C
Protection type	
Mounting (e.g. cabinet)	IP54
Housing	IP40
Terminals	IP20
Mechanical data	
Housing material	
Housing	PPO UL 94 V0
Front	ABS UL 94 V0
Max. cross section of external conductors with screw terminals:	
1 core flexible	0.20 - 4.00 mm²
2 core, same cross section, flexible	
with crimp connectors, without insulating sleeve	0.20 - 2.50 mm²
without crimp connectors or with TWIN crimp connectors	0.20 - 2.50 mm²
Torque setting with screw terminals	0.60 Nm
Dimensions (H x W x D)	87.0 x 22.5 x 121.0 mm
Weight	200 g

The standards current on **06/04** apply.

Order reference			
Type	Features	Terminals	Order no.
PNOZ X2	24 VAC 24 VDC	Screw terminals	774 303

X-ON Electronics

Largest Supplier of Electrical and Electronic Components

Click to view similar products for [Emergency Stop Switches / E-Stop Switches](#) category:

Click to view products by [Pilz](#) manufacturer:

Other Similar products are found below :

[84-5021.2B40](#) [84-6830.0020](#) [A01ESSP8](#) [A22EL-M-24A-11B](#) [AVN302N-R](#) [A165E-S-01\(STOP\)](#) [AYLD2212602SN-R-TK962](#)
[AVLD39911N-R-24V](#) [A22Z-EG22](#) [A165E-SY](#) [3100.0110Y](#) [3050.1302Y](#) [3SE2243-0XX40](#) [3SK1111-2AB30](#) [3SK1211-1BB40](#) [44-710](#) [84-](#)
[6841.2B20](#) [84-6830.0040](#) [H3141AAKAA](#) [A165E-R-24D-01](#) [E3102AAAAB](#) [A22E-M-03](#) [ZA2BV05](#) [A22EL-M-T2-01](#) [951FY000-WO](#)
[ER6022-022N](#) [952+2000-00](#) [ES3S51653](#) [601+0000-OP](#) [E3101AAAAB](#) [84-5130.0040](#) [CS AR-05V024](#) [CS AR-20V024](#) [CS AR-22V024](#) [DS](#)
[AE1VA](#) [DS KB2A](#) [DS KB3A](#) [HE2G-21SHE-L-K](#) [HE6B-M211Y](#) [774191](#) [774316](#) [777760](#) [R1.100.0129.0 SMA0129- NO/NO](#)
[R1.188.0640.0 SNV 4063KL-A](#) [R1.188.1810.0 SNA 4043K-A](#) [R1.188.1840.0 SNA 4043K-A](#) [SR BD40ALK-B02F](#) [AVLW39911D-R-120V](#)
[AYD311NUG](#) [AVLD32211DNUR](#)