



Up to Category 4, EN 954-1 PNOZ X3



Safety relay for monitoring E-STOP pushbuttons and safety gates.

Approvals

	PNOZ X3
	◆
	◆
	◆

Unit features

- ▶ Positive-guided relay outputs:
 - 3 safety contacts (N/O), instantaneous
 - 1 auxiliary contact (N/C), instantaneous
- ▶ 1 semiconductor output
- ▶ Connection options for:
 - E-STOP pushbutton
 - Safety gate limit switch
 - Reset button
- ▶ LED indicator for:
 - Switch status channel 1/2
 - Supply voltage
- ▶ Semiconductor output signals:
 - Switch status channel 1/2
- ▶ See order reference for unit types

Safety features

- The relay meets the following safety requirements:
- ▶ The circuit is redundant with built-in self-monitoring.
 - ▶ The safety function remains effective in the case of a component failure.
 - ▶ The correct opening and closing of the safety function relays is tested automatically in each on-off cycle.
 - ▶ The transformer is short circuit-proof. An electronic fuse is used on a DC supply.

Unit description

The safety relay meets the requirements of EN 60947-5-1, EN 60204-1 and VDE 0113-1 and may be used in applications with

- ▶ E-STOP pushbuttons
- ▶ Safety gates

Block diagram

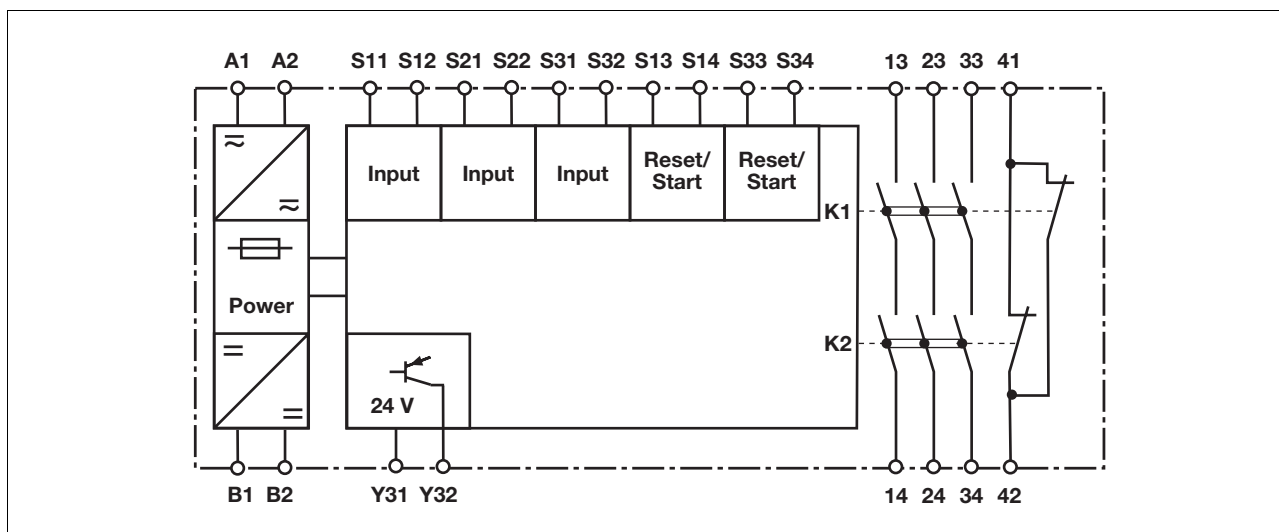

Up to Category 4, EN 954-1 PNOZ X3

Function description

- ▶ Single-channel operation: no redundancy in the input circuit, earth faults in the reset and input circuit are detected.
- ▶ Dual-channel operation with detection of shorts across contacts: redundant input circuit, detects
 - earth faults in the reset and input circuit,
 - short circuits in the input circuit and, with a monitored reset, in the reset circuit too,
 - shorts between contacts in the input circuit.
- ▶ Automatic start: Unit is active once the input circuit has been closed.
- ▶ Monitored reset: Unit is active once the input circuit is closed and once the reset circuit is closed after the waiting period has elapsed (see technical details).
- ▶ Increase in the number of available contacts by connecting contact expander modules or external contactors/relays.

Timing diagram

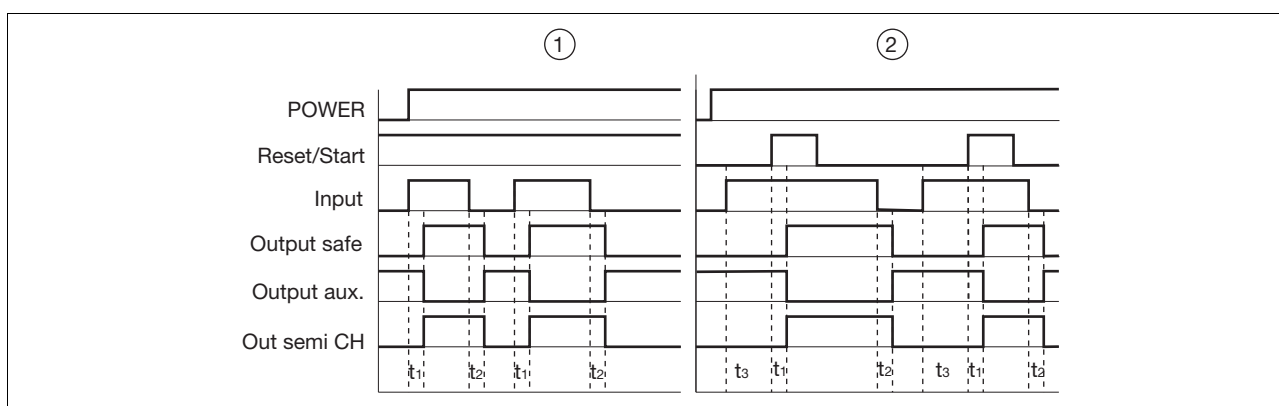

Key

- ▶ Power: Supply voltage
- ▶ Reset/start: Reset circuit S13-S14, S33-S34
- ▶ Input: Input circuits S11-S12, S21-S22, S31-S32
- ▶ Output safe: Safety contacts 13-14, 23-24, 33-34
- ▶ Output aux.: Auxiliary contacts 41-42
- ▶ Out semi CH: Semiconductor output switch status channel 1/2
- ▶ ①: Automatic reset
- ▶ ②: Monitored reset
- ▶ t_1 : Switch-on delay
- ▶ t_2 : Delay-on de-energisation
- ▶ t_3 : Waiting period

Wiring

Please note:

- ▶ Information given in the “Technical details” must be followed.
- ▶ Outputs 13-14, 23-24, 33-34 are safety contacts, output 41-42 is an auxiliary contact (e.g. for display).
- ▶ To prevent contact welding, a fuse should be connected before the output contacts (see technical details).
- ▶ Calculation of the max. cable runs l_{max} in the input circuit:

$$l_{max} = \frac{R_{lmax}}{R_l / km}$$

R_{lmax} = max. overall cable resistance (see technical details)

R_l / km = cable resistance/km

- ▶ Use copper wire that can withstand 60/75 °C.

- ▶ Sufficient fuse protection must be provided on all output contacts with capacitive and inductive loads.

Up to Category 4, EN 954-1 PNOZ X3

Preparing for operation

► Supply voltage

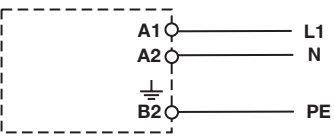
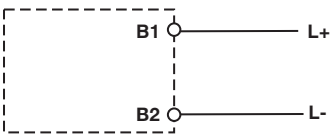
Supply voltage	AC	DC
		

► Input circuit

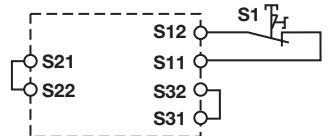
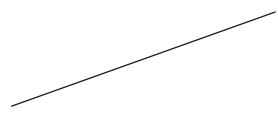
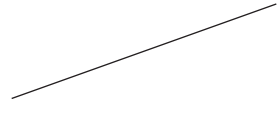
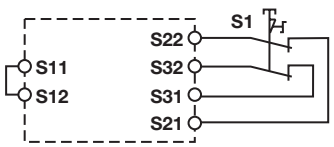
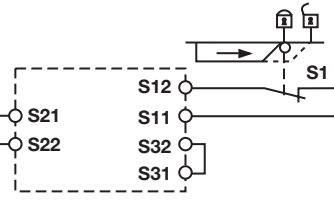
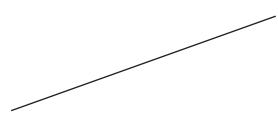
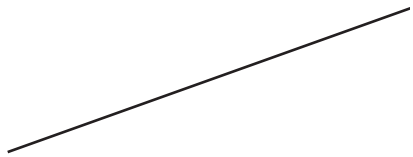
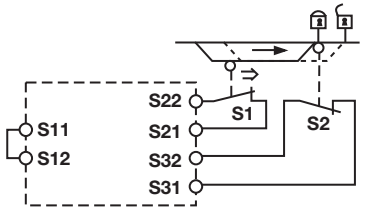
Input circuit	Single-channel	Dual-channel
E-STOP without detection of shorts across contacts		
E-STOP with detection of shorts across contacts		
Safety gate without detection of shorts across contacts		
Safety gate with detection of shorts across contacts		

Up to Category 4, EN 954-1 PNOZ X3

▶ Reset circuit

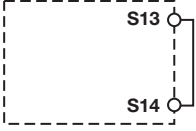
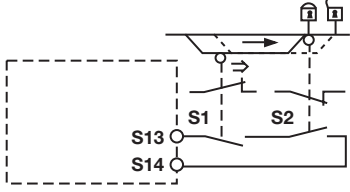
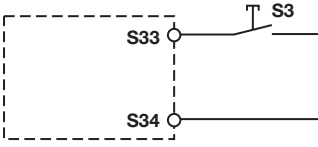
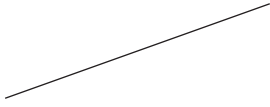
Reset circuit	E-STOP wiring, safety gate	Safety gate (dual-channel)
Automatic reset		
Monitored reset		

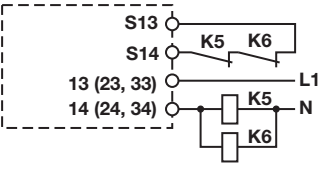
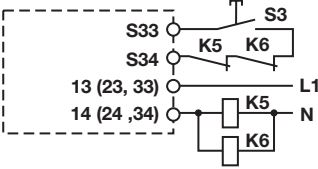

▶ Feedback loop

Feedback loop	Automatic reset	Monitored reset
Contacts from external contactors		

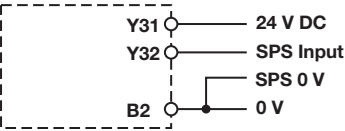
▶ Semiconductor output



▶ Key

S1/S2	E-STOP/safety gate switch
S3	Reset button
	Switch operated
	Gate open
	Gate closed

Up to Category 4, EN 954-1 PNOZ X3

Terminal configuration

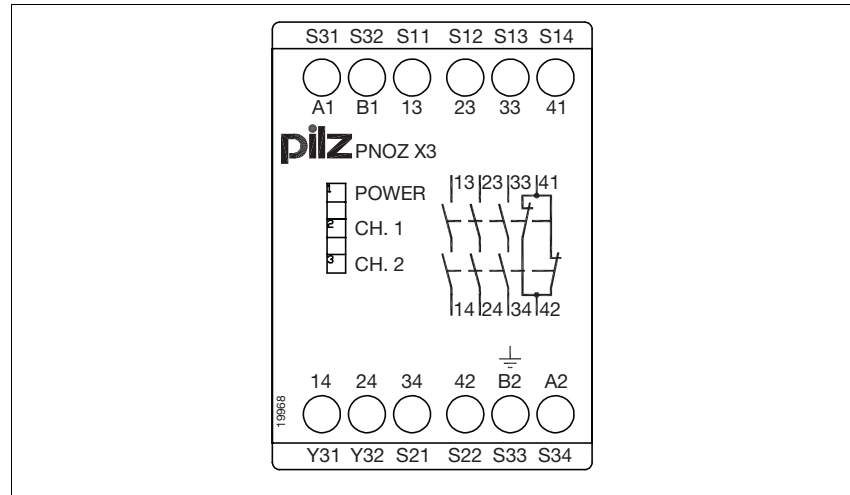

Installation

- ▶ The safety relay should be installed in a control cabinet with a protection type of at least IP54.
- ▶ Use the notch on the rear of the unit to attach it to a DIN rail.
- ▶ Ensure the unit is mounted securely on a vertical DIN rail (35 mm) by using a fixing element (e.g. retaining bracket or an end angle).

Dimensions

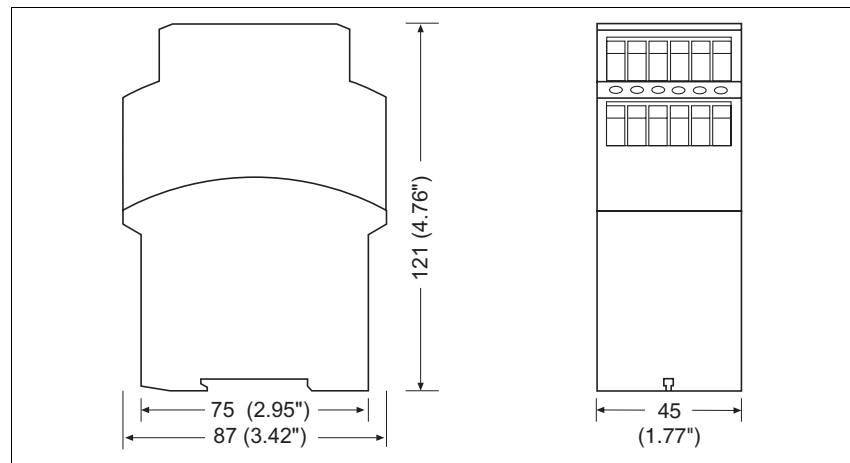

Up to Category 4, EN 954-1 PNOZ X3

Notice

This data sheet is only intended for use during configuration. For installation and operation, please refer to the operating instructions supplied with the unit.

Service life graph

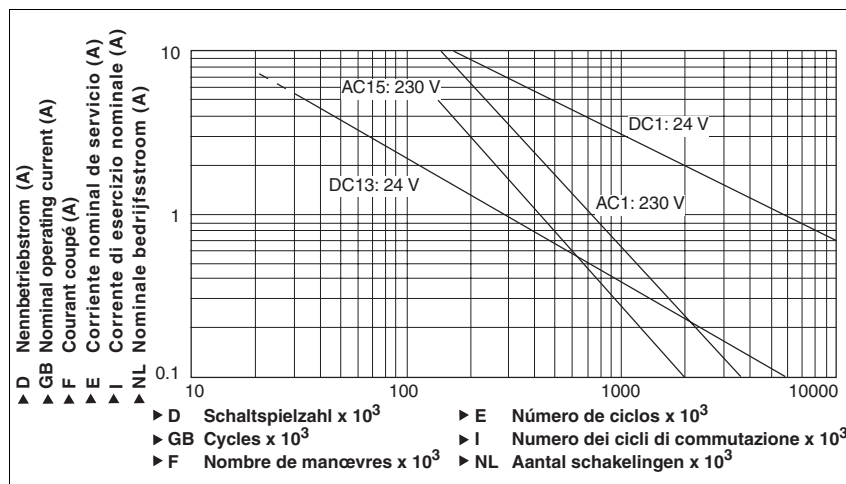

Technical details

Electrical data

Supply voltage	
Supply voltage U _B AC	24 V, 42 V, 48 V, 110 V, 115 V, 120 V, 230 V, 240 V
Supply voltage U _B DC	24 V
Voltage tolerance	-15 %/+10 %
Power consumption at U _B AC	5.0 VA
Power consumption at U _B DC	2.5 W
Frequency range AC	50 - 60 Hz
Residual ripple DC	160 %
Voltage and current at	
Input circuit DC: 24.0 V	50.0 mA
Reset circuit DC: 24.0 V	35.0 mA
Feedback loop DC: 24.0 V	20.0 mA
Number of output contacts	
Safety contacts (S) instantaneous:	3
Auxiliary contacts (N/C):	1
Category of output contacts in accordance with EN 954-1	
Safety contacts (S) instantaneous:	4
Utilisation category in accordance with EN 60947-4-1	
Safety contacts: AC1 at 240 V	I _{min} : 0.01 A , I _{max} : 8.0 A P _{max} : 2000 VA
Safety contacts: DC1 at 24 V	I _{min} : 0.01 A , I _{max} : 8.0 A P _{max} : 200 W
Auxiliary contacts: AC1 at 240 V	I _{min} : 0.01 A , I _{max} : 8.0 A P _{max} : 2000 VA
Auxiliary contacts: DC1 at 24 V	I _{min} : 0.01 A , I _{max} : 8.0 A P _{max} : 200 W
Utilisation category in accordance with EN 60947-5-1	
Safety contacts: AC15 at 230 V	I _{max} : 5.0 A
Safety contacts: DC13 at 24 V (6 cycles/min)	I _{max} : 6.0 A
Auxiliary contacts: AC15 at 230 V	I _{max} : 5.0 A
Auxiliary contacts: DC13 at 24 V (6 cycles/min)	I _{max} : 6.0 A
Contact material	AgSnO₂ + 0.2 µm Au

Up to Category 4, EN 954-1 PNOZ X3

Electrical data	
External contact fuse protection ($I_K = 1 \text{ kA}$) to EN 60947-5-1	
Blow-out fuse, quick	
Safety contacts:	10 A
Auxiliary contacts:	10 A
Blow-out fuse, slow	
Safety contacts:	6 A
Auxiliary contacts:	6 A
Circuit breaker 24 VAC/DC, characteristic B/C	
Safety contacts:	6 A
Auxiliary contacts:	6 A
Semiconductor outputs (short circuit proof)	24.0 V DC, 20 mA
External supply voltage	24.0 V DC
Voltage tolerance	-20 %/+20 %
Max. overall cable resistance R_{lmax} input circuits, reset circuits	
single-channel at U_B DC	150 Ohm
single-channel at U_B AC	180 Ohm
dual-channel with detect. of shorts across contacts at U_B DC	15 Ohm
dual-channel with detect. of shorts across contacts at U_B AC	30 Ohm
Times	
Switch-on delay	
with automatic reset typ.	250 ms
with automatic reset max.	500 ms
with automatic reset after power on typ.	280 ms
with automatic reset after power on max.	550 ms
on monitored reset with rising edge typ.	35 ms
on monitored reset with rising edge max.	50 ms
Delay-on de-energisation	
with E-STOP typ.	15 ms
with E-STOP max.	30 ms
with power failure typ.	50 ms
with power failure max.	70 ms
Recovery time at max. switching frequency 1/s	
after E-STOP	50 ms
after power failure	100 ms
Waiting period with a monitored reset	
with rising edge	300 ms
Min. start pulse duration with a monitored reset	
with rising edge	30 ms
Simultaneity, channel 1 and 2	∞
Supply interruption before de-energisation	20 ms
Environmental data	
EMC	EN 12015, EN 12016, EN 60947-5-1, EN 61000-6-2
Vibration to EN 60068-2-6	
Frequency	10 - 55 Hz
Amplitude	0.35 mm
Climatic suitability	EN 60068-2-78
Airgap creepage	EN 60947-1
Rated insulation voltage	250 V
Rated impulse withstand voltage	4.0 kV
Ambient temperature	-20 - 55 °C
Storage temperature	-40 - 85 °C
Protection type	
Mounting (e.g. cabinet)	IP54
Housing	IP40
Terminals	IP20

Up to Category 4, EN 954-1 PNOZ X3

Mechanical data

Housing material	
Housing	PPO UL 94 V0
Front	ABS UL 94 V0
Max. cross section of external conductors with screw terminals	
1 core flexible	0.20 - 4.00 mm² , 24 - 10 AWG
2 core, same cross section, flexible:	
with crimp connectors, without insulating sleeve	0.20 - 2.50 mm² , 24 - 14 AWG
without crimp connectors or with TWIN crimp connectors	0.20 - 2.50 mm² , 24 - 14 AWG
Torque setting with screw terminals	0.60 Nm
Dimensions	
Height	87.0 mm
Width	45.0 mm
Depth	121.0 mm
Weight	375 g

The standards current on **08/02** apply.

Conventional thermal current

Number of contacts	I_{th} (A) at U_B DC	I_{th} (A) at U_B AC
1	8.00 A	8.00 A
2	8.00 A	7.50 A
3	7.00 A	6.50 A

Order reference

Type	Features	Terminals	Order no.
PNOZ X3	24 VAC/DC 24 VDC	Screw terminals	774 310
PNOZ X3	42 VAC 24 VDC	Screw terminals	774 311
PNOZ X3	48 VAC 24 VDC	Screw terminals	774 312
PNOZ X3	110 VAC 24 VDC	Screw terminals	774 314
PNOZ X3	115 VAC 24 VDC	Screw terminals	774 315
PNOZ X3	120 VAC 24 VDC	Screw terminals	774 316
PNOZ X3	230 VAC 24 VDC	Screw terminals	774 318
PNOZ X3	240 VAC 24 VDC	Screw terminals	774 319

X-ON Electronics

Largest Supplier of Electrical and Electronic Components

Click to view similar products for [Emergency Stop Switches / E-Stop Switches](#) category:

Click to view products by [Pilz](#) manufacturer:

Other Similar products are found below :

[84-5021.2B40](#) [84-6830.0020](#) [A01ESSP8](#) [A22EL-M-24A-11B](#) [AVN302N-R](#) [A165E-S-01\(STOP\)](#) [AYLD2212602SN-R-TK962](#)
[AVLD39911N-R-24V](#) [A22Z-EG22](#) [A165E-SY](#) [3100.0110Y](#) [3050.1302Y](#) [3SE2243-0XX40](#) [3SK1111-2AB30](#) [3SK1211-1BB40](#) [44-710](#) [84-](#)
[6841.2B20](#) [84-6830.0040](#) [H3141AAKAA](#) [A165E-R-24D-01](#) [E3102AAAAB](#) [A22E-M-03](#) [ZA2BV05](#) [A22EL-M-T2-01](#) [951FY000-WO](#)
[ER6022-022N](#) [952+2000-00](#) [ES3S51653](#) [601+0000-OP](#) [E3101AAAAB](#) [84-5130.0040](#) [CS AR-05V024](#) [CS AR-22V024](#) [DS AE1VA](#) [DS](#)
[KB2A](#) [DS KB3A](#) [HE2G-21SHE-L-K](#) [HE6B-M211Y](#) [774191](#) [774316](#) [777760](#) [R1.100.0129.0 SMA0129- NO/NO](#) [R1.188.0640.0 SNV](#)
[4063KL-A](#) [R1.188.1810.0 SNA 4043K-A](#) [R1.188.1840.0 SNA 4043K-A](#) [SR BD40ALK-B02F](#) [AVLW39911D-R-120V](#) [AYD311NUG](#)
[AVLD32211DNUR](#) [84-5040.0020.0049](#)