

**RKT**

Aktor-/Sensor-Anschlussleitung, M12-Kupplung mit selbstsicherndem Schraubverschluss und angespritztem Kabel  
 8-6-polig: zum Anschluss an steckbaren Miniatur-Sensor-Verteiler Typ SBS  
 12-polig: zum Anschluss an steckbaren Aktor-Sensor-Verteiler Typ ASBSM

Actuator/sensor cordset, single-ended, M12 female connector with self-locking threaded joint and molded cable  
 8-6-poles: to connect at plug-gable miniature sensor distribution box type SBS  
 12 poles: to connect at plug-gable miniature actuator/sensor distribution box type ASBSM

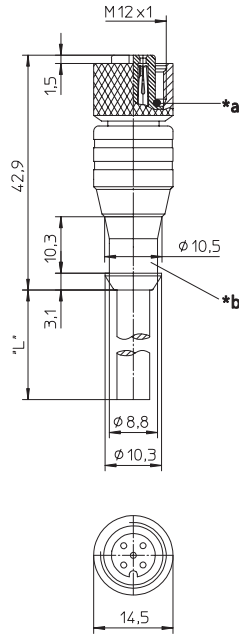

\*a O-Ring  
 O-ring  
 \*b Schutzschlauchmontage  
 hose mounting

**RKWT**

Aktor-/Sensor-Anschlussleitung, M12-Winkelkupplung mit selbstsicherndem Schraubverschluss und angespritztem Kabel  
 8-6-polig: zum Anschluss an steckbaren Miniatur-Sensor-Verteiler Typ SBS

Actuator/sensor cordset, single-ended, M12 female right angle connector with self-locking threaded joint and molded cable  
 8-6-poles: to connect at plug-gable miniature sensor distribution box type SBS

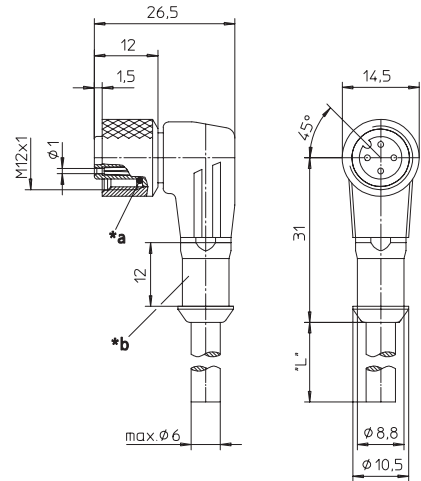

\*a O-Ring  
 O-ring  
 \*b Schutzschlauchmontage  
 hose mounting

**Pinbelegung**  
 Pin assignment

**3-polig**  
 3 poles

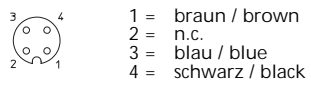

**4-polig**  
 4 poles

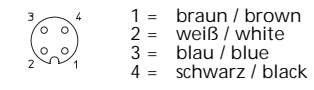

**5-polig**  
 5 poles

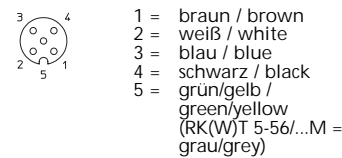

**6-polig**  
 6 poles

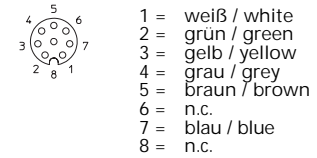

**8-polig**  
 8 poles

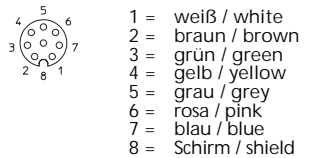



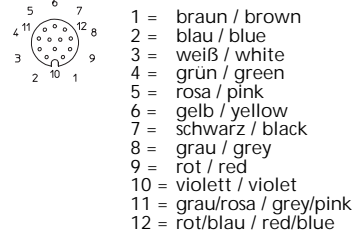



















































**12-polig**  
 12 poles



## Anschlussleitungen für Aktoren, Sensoren und Verteiler Cordsets, single-ended, for actuators, sensors and distribution boxes

<b>Technische Daten</b>		<b>Technical data</b>	
<b>Umgebungstemperatur</b>	-25°C / +80°C	<b>Operating temperature range</b>	-25°C / +80°C
<b>Werkstoffe</b>		<b>Materials</b>	
Gehäuse / Griffkörper	TPU	Housing / Molded body	TPU
Kontaktträger	TPU	Insert	TPU
Kontakt	CuSn (12-polig: CuZn), unternickelt und 0,3 µm vergoldet	Contact	CuSn (12 poles: CuZn), pre-nickelated and 0.3 microns gold-plated
Gewindebuchse / Rändelschraube/-mutter / Sechskantschraube/-mutter / Hülse O-Ring	CuZn, vernickelt FKM	Receptacle shell / knurled screw/nut / hexagon screw/nut / sleeve O-ring	CuZn, nickel-plated FKM
<b>Mechanische Daten</b>		<b>Mechanical data</b>	
Schutzart	IP 67 Nur im verschraubten Zustand mit den dazugehörigen Gegenstücken.	Degree of protection	IP 67 Only in locked position with its proper counterparts.
<b>Elektrische Daten</b>		<b>Electrical data</b>	
Durchgangswiderstand	≤ 5 mΩ	Contact resistance	≤ 5 mΩ
Nennstrom bei 40°C	3- bis 5-polig 4 A, 6- bis 12-polig 2 A	Nominal current at 40°C	3-5 poles 4 A, 6-12 poles 2 A
Nennspannung	3- bis 4-polig 240 V, 5-polig 60 V, 6- bis 12-polig 30 V	Nominal voltage	3-4 poles 240 V, 5 poles 60 V, 6-12 poles 30 V
Bemessungsspannung	3- bis 4-polig 250 V, 5-polig 63 V, 6- bis 12-polig 36 V	Rated voltage	3-4 poles 250 V, 5 poles 63 V, 6-12 poles 36 V
Prüfspannung	3- bis 4-polig 2,0 kV eff. / 60 s 5- bis 8-polig 1,5 kV eff. / 60 s 12-polig 0,5 kV eff. / 60 s	Test voltage	3-4 poles 2.0 kV eff. / 60 s 5-8 poles 1.5 kV eff. / 60 s 12 poles 0.5 kV eff. / 60 s
Isolationswiderstand	> 10 <sup>9</sup> Ω	Insulation resistance	> 10 <sup>9</sup> Ω
Verschmutzungsgrad	3	Pollution degree	3

Bestellbezeichnung Designation		Polzahl Poles	Mantel Outer jacket	
RKT 4-3-06/... M	RKWT 4-3-06/... M		PVC	 
RKT 4-3-224/... M	RKWT 4-3-224/... M	3	PUR halogenfrei / halogen free	   
RKT 4-3-260/... M	RKWT 4-3-260/... M		PUR halogenfrei / halogen free schweißfunkenfest / welding spark proof	    
RKT 4-07/... M	RKWT 4-07/... M		PVC	 
RKT 4-225/... M	RKWT 4-225/... M	4	PUR halogenfrei / halogen free	   
RKT 4-251/... M	RKWT 4-251/... M		PUR halogenfrei / halogen free schweißfunkenfest / welding spark proof	    
RKT 5-56/... M	RKWT 5-56/... M		PVC	 
RKT 5-226/... P89 <small>(Pin 2 und 4 nicht belegt / Pin 2 and 4 not connected)</small>	RKWT 5-226/... M	5	PUR halogenfrei / halogen free	   
RKT 5-228/... M	RKWT 5-228/... M		PUR halogenfrei / halogen free	   
RKT 5-259/... M	RKWT 5-259/... M		PUR halogenfrei / halogen free schweißfunkenfest / welding spark proof	    
RKT 8-6-268/... M	RKWT 8-6-268/... M	6	PUR halogenfrei / halogen free schweißfunkenfest / welding spark proof	     
RKT 8-6-337/... M	RKWT 8-6-337/... M		PUR halogenfrei / halogen free	   
RKT 8-282/... M	RKWT 8-282/... M	8	PUR	   
RKT 12-348/... M	RKWT 12-348/... M	12	PUR halogenfrei / halogen free	  

Standardlängen: 2 M / 5 M / 10 M  
Andere Kabellängen oder Leitungsaufbauten auf Anfrage.

Standard lengths: 2 M / 5 M / 10 M  
Other cable lengths or cable specifications on request.

## X-ON Electronics

Largest Supplier of Electrical and Electronic Components

*Click to view similar products for [Specialised Cables](#) category:*

*Click to view products by [Lumberg](#) manufacturer:*

Other Similar products are found below :

[GP-IE515546DS-002](#) [96CB-L2020PIB2](#) [1200740161](#) [R88ACAKA0015SRE](#) [R88ACAWL005SDE](#) [R88ACRGD0R3C](#) [1300660042](#)  
[1300660201](#) [1971465-2](#) [22733-8](#) [2R7004A20F060](#) [SSL009PC2DC012N](#) [FC2A-KC6C](#) [CCSFCBF2](#) [R7ACAB005S](#) [XS2WM12PUR4SA10M](#)  
[XS2WM12PVC4SA10M](#) [05AU05](#) [UCABLE](#) [10114734-2010LF](#) [XW2Z010H3](#) [XW2Z010H1](#) [5-1589827-8](#) [5-1589827-4](#) [861084-1](#)  
[XW2Z200JB24](#) [5-1589956-8](#) [CR4000A76M020](#) [1201140211](#) [1300140039](#) [CR4000A76M005](#) [CR4006A76M005](#) [10077488-N0550FDLF](#)  
[XW2ZRY150C](#) [I4JPBJLUXX100](#) [I4JPBJLUXX50](#) [CM06](#) [CM06W](#) [POE004](#) [0243 009 05](#) [0243 009 20](#) [0243 009 36](#) [0243 009 26](#) [0243 009](#)  
[23](#) [0243 009 01](#) [0243 009 30](#) [0243 008 05](#) [0243 008 20](#) [0243 008 36](#) [0243 008 23](#)