

Features

- 1 & 2 Pole - Low profile (15.7 mm height)
- 41.31 - 1 Pole 12 A (3.5 mm pin pitch)
- 41.52 - 2 Pole 8 A (5 mm pin pitch)
- 41.61 - 1 Pole 16 A (5 mm pin pitch)

PCB mount

- direct or via PCB socket
- 35 mm rail mount
- via screw and screwless sockets

- DC coils - 400 mW
- 8 mm, 6 kV (1.2/50 μ s) isolation, coil-contacts
- Cadmium Free contact materials
- Flux proof: RT II standard, (RT III option)

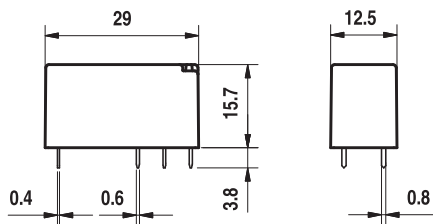

FOR UL HORSEPOWER AND PILOT DUTY RATINGS
SEE "General technical information" page V

41.31



- 3.5 mm contact pin pitch
- 1 Pole 12 A
- PCB direct or via socket

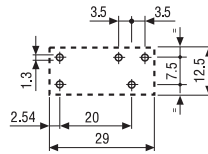
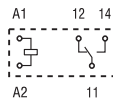

Copper side view

41.52



- 5 mm contact pin pitch
- 2 Pole 8 A
- PCB direct or via socket

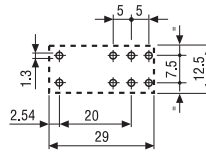
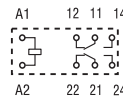

Copper side view

41.61



- 5 mm contact pin pitch
- 1 Pole 16 A
- PCB direct or via socket

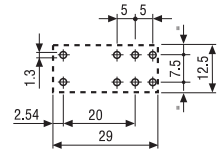
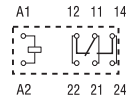

Copper side view

Contact specification

Contact configuration	1 CO (SPDT)	2 CO (DPDT)	1 CO (SPDT)
Rated current/Maximum peak current A	12/25	8/15	16/30
Rated voltage/Maximum switching voltage V AC	250/400	250/400	250/400
Rated load AC1 VA	3,000	2,000	4,000
Rated load AC15 (230 V AC) VA	600	400	750
Single phase motor rating (230 V AC) kW	0.5	0.3	0.5
Breaking capacity DC1: 30/110/220 V A	12/0.3/0.12	8/0.3/0.12	16/0.3/0.12
Minimum switching load mW (V/mA)	300 (5/5)	300 (5/5)	300 (5/5)
Standard contact material	AgNi	AgNi	AgNi

Coil specification

Nominal voltage (U _N)	V AC (50/60 Hz)	—	—	—
	V DC	12 - 24 - 48 - 60 - 110	12 - 24 - 48 - 60 - 110	12 - 24 - 48 - 60 - 110
Rated power AC/DC	VA (50 Hz)/W	—/0.4	—/0.4	—/0.4
Operating range	AC	—	—	—
	DC	(0.7...1.5)U _N	(0.7...1.5)U _N	(0.7...1.5)U _N
Holding voltage	AC/DC	—/0.4U _N	—/0.4 U _N	—/0.4 U _N
Must drop-out voltage	AC/DC	—/0.1U _N	—/0.1 U _N	—/0.1 U _N

Technical data

Mechanical life AC/DC	cycles	—/30·10 ⁶	—/30·10 ⁶	—/30·10 ⁶
Electrical life at rated load AC1	cycles	150 · 10 ³	80 · 10 ³	70 · 10 ³
Operate/release time	ms	5/4	5/4	5/4
Insulation between coil and contacts (1.2/50 μ s)	kV	6 (8 mm)	6 (8 mm)	6 (8 mm)
Dielectric strength between open contacts	V AC	1,000	1,000	1,000
Ambient temperature range	°C	—40...+85	—40...+85	—40...+85
Environmental protection		RT II	RT II	RT II

Approvals (according to type)

Features

Solid State Relays

Printed circuit mount:

- direct or via PCB socket

35 mm rail mount:

- via screw or screwless sockets

- Single circuit output switching options
 - 5 A 24 V DC
 - 3 A 240 V AC
- Silent, high speed switching with long electrical life
- Low profile (15.7 mm)
- Wash tight: RT III
- 2,500 V insulation, input-output

41.81 - 9024



- 5 A, 24 V DC output switching
- PCB or 93 Series sockets

41.81 - 8240



- 3 A, 240 V AC output switching
- Zero crossing switching
- PCB or 93 Series sockets

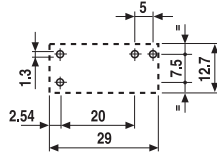
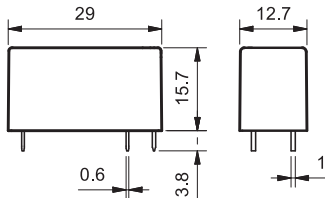
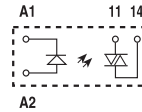
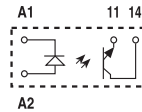

Copper side view

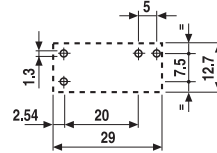

Copper side view

Output circuit					
Contact configuration		1 NO (SPST-NO)		1 NO (SPST-NO)	
Rated current/Maximum peak current (100 µs)A		5/40		3/40	
Rated voltage/Maximum blocking voltage	V	(24/35)DC		(240/275)AC	
Switching voltage range	V	(1.5...35)DC		(12...275)AC	
Minimum switching current	mA	1		50	
Max. "OFF-state" leakage current	mA	0.01		1	
Max. "ON-state" voltage drop	V	0.3		1.1	
Input circuit					
Nominal voltage	V DC	12	24	12	24
Operating range	V DC	8...17	14...32	8...17	14...32
Control current	mA	5.5	9	8.8	9
Release voltage	V DC	4	9	4	9
Impedance	Ω	1,550	2,600	1,030	2,600
Technical data					
Operate/release time	ms	0.05/0.25		10/10	
Dielectric strength between input/output	V	2,500		2,500	
Ambient temperature range	°C	-20...+60		-20...+60	
Environmental protection		RT III		RT III	
Approvals (according to type)					

Ordering information

Electromechanical relay (EMR)

Example: 41 series low-profile PCB relay, 2 CO (DPDT), 24 V DC coil.

4 1 . 5 2 . 9 . 0 2 4 . 0 0 1 0

A B C D

Series ————

Type ————
 3 = PCB - 3.5 mm pinning
 5 = PCB - 5 mm pinning
 6 = PCB - 5 mm pinning

No. of poles ————
 1 = 1 pole for
 41.31, 12 A
 41.61, 16 A
 2 = 2 pole for
 41.52, 8 A

Coil version ————
 9 = DC

Coil voltage ————
 See coil specifications

A: Contact material
 0 = Standard AgNi
 4 = AgSnO₂
 5 = AgNi + Au (5 µm)

B: Contact circuit
 0 = CO (nPDT)
 3 = NO (nPST)

C: Options
 1 = None

D: Special versions
 0 = Flux proof (RT II)
 1 = Wash tight (RT III)

Selecting features and options: only combinations in the same row are possible.
 Preferred selections for best availability are shown in **bold**.

Type	Coil version	A	B	C	D
41.31	DC	0 - 4 - 5	0 - 3	1	0 - 1
41.52	DC	0 - 5	0 - 3	1	0 - 1
41.61	DC	0 - 4	0 - 3	1	0 - 1

Solid state relay (SSR)

Example: 41 series SSR relay, 5 A output, 24 V DC supply.

4 1 . 8 1 . 7 . 0 2 4 . 9 0 2 4

Series ————

Type ————
 8 = SSR type

Output ————
 1 = 1 NO (SPST-NO)

Input circuit ————
 See input specifications

Output circuit
 9024 = 5 A - 24 V DC
 8240 = 3 A - 240 V AC

Electromechanical relay

Technical data

Insulation according to EN 61810-1					
		1 pole		2 pole	
Nominal voltage of supply system	V AC	230/400		230/400	
Rated insulation voltage	V AC	250	400	250	400
Pollution degree		3	2	3	2
Insulation between coil and contact set					
Type of insulation		Reinforced (8 mm)		Reinforced (8 mm)	
Overvoltage category		III		III	
Rated impulse voltage	kV (1.2/50 µs)	6		6	
Dielectric strength	V AC	4,000		4,000	
Insulation between adjacent contacts					
Type of insulation		—		Basic	
Overvoltage category		—		III	
Rated impulse voltage	kV (1.2/50 µs)	—		4	
Dielectric strength	V AC	—		2,000	
Insulation between open contacts					
Type of disconnection		Micro-disconnection		Micro-disconnection	
Dielectric strength	V AC/kV (1.2/50 µs)	1,000/1.5		1,000/1.5	
Conducted disturbance immunity					
Burst (5...50)ns, 5 kHz, on A1 - A2		EN 61000-4-4		level 4 (4 kV)	
Surge (1.2/50 µs) on A1 - A2 (differential mode)		EN 61000-4-5		level 3 (2 kV)	
Other data					
Bounce time: NO/NC	ms	2/5			
Vibration resistance (5...55)Hz: NO/NC	g	15/2			
Shock resistance	g	16			
Power lost to the environment	without contact current	W	0.4		
	with rated current	W	1.7 (41.31)	1.2 (41.52)	1.8 (41.61)
Recommended distance between relays mounted on PCB	mm	≥ 5			

Contact specification

F 41 - Electrical life (AC) v contact current
Types 41.31/61

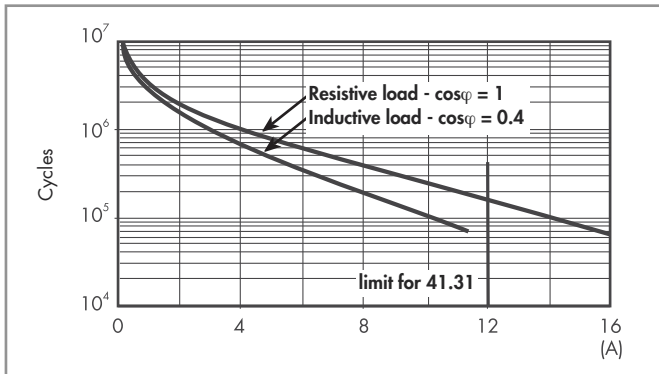

F 41 - Electrical life (AC) v contact current
Type 41.52

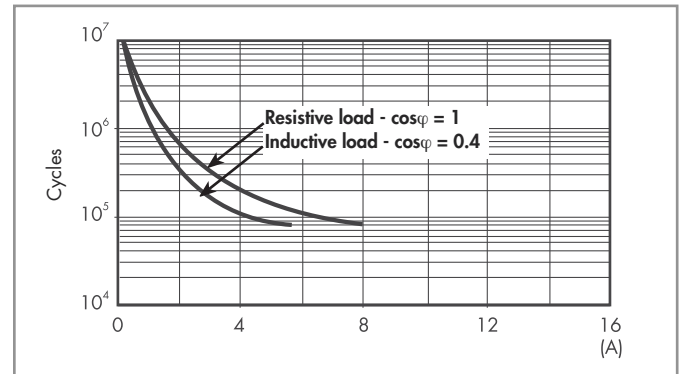

H 41- Maximum DC1 breaking capacity

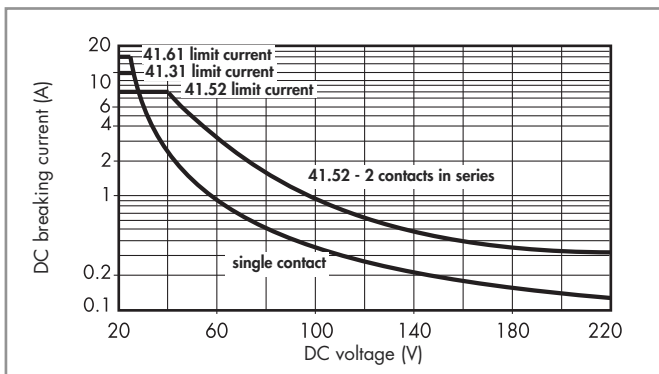

- When switching a resistive load (DC1) having voltage and current values under the curve, an electrical life of $\geq 100 \cdot 10^3$ can be expected.
- In the case of DC13 loads, the connection of a diode in parallel with the load will permit a similar electrical life as for a DC1 load.
Note: the release time for the load will be increased.

Coil specifications

DC coil data

Nominal voltage U_N V	Coil code	Operating range		Resistance R Ω	Rated coil consumption I at U_N mA
		U_{min} V	U_{max} V		
12	9.012	8.4	18	360	33.3
24	9.024	16.8	36	1,440	16.7
48	9.048	33.6	72	5,760	8.3
60	9.060	42	90	9,000	6.6
110	9.110	77	165	24,200	4.5

R 41 - DC coil operating range v ambient temperature

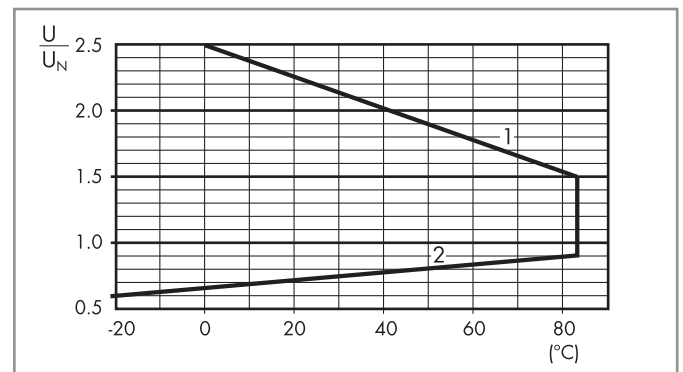

- 1 - Max. permitted coil voltage.
- 2 - Min. pick-up voltage with coil at ambient temperature.

Solid state relay

Technical data

Other data		41.81 - 9024	41.81 - 8240
Power lost to the environment	without current	W	0.25
	with maximum current	W	1.75

Input specification

Input data - DC types

Nominal voltage U_N	Input code	Operating range		Release voltage	Impedance	Control current I at U_N
		U_{min}	U_{max}			
V		V	V	V	Ω	mA
12	7.012	8	17	4	1,550	5.5
24	7.024	14	32	9	2,600	9

Output specification

L 41 - Output current v ambient temperature
SSR - 5 A DC output types

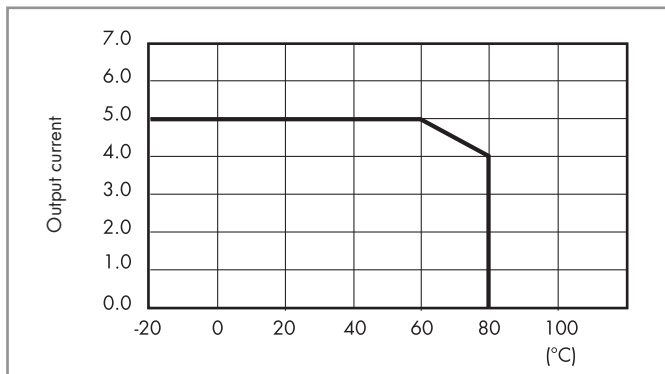

L 41 - Output current v ambient temperature
SSR - 3 A AC output types

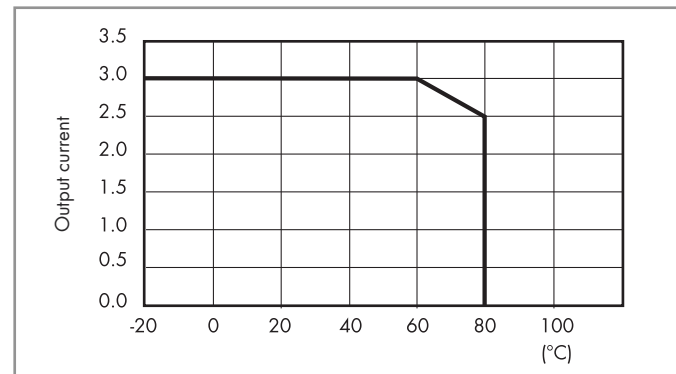



93.02

Approvals
(according to type):



Screw terminal socket 35 mm (EN 60715) mounting

Supply voltage	Relay type	Socket type
6 V AC/DC	41.52.9.005.0010	93.02.0.024
12 V AC/DC	41.52.9.012.0010	93.02.0.024
24 V AC/DC	41.52.9.024.0010 or 41.81.7.024.xxxx	93.02.0.024
60 V AC/DC	41.52.9.060.0010	93.02.0.060
(110...125)V AC/DC	41.52.9.110.0010	93.02.0.125
(220...240)V AC/DC	41.52.9.110.0010	93.02.0.240
(230...240)V AC	41.52.9.110.0010	93.02.8.230
6 V DC	41.52.9.005.0010	93.02.7.024
12 V DC	41.52.9.012.0010 or 41.81.7.012.xxxx	93.02.7.024
24 V DC	41.52.9.024.0010 or 41.81.7.024.xxxx	93.02.7.024
48 V DC	41.52.9.048.0010	93.02.7.060
60 V DC	41.52.9.060.0010	93.02.7.060

Accessories

8-way jumper link	093.08 (see specification next page)
Plastic separator	093.01 (see specification next page)
Sheet of marker tags, 72 tags	090.72 (see specification next page)

Technical data

Rated values	10 A - 250 V		
Dielectric strength	6 kV (1.2/50 μ s) between coil and contacts		
Protection category	IP 20		
Ambient temperature	°C (-40...+70)°C - ($U_N \leq 60$ V DC), (-40...+55)°C - ($U_N > 60$ V DC)		
⊕ Screw torque	Nm	0.5	
Wire strip length	mm	8	
Max. wire size for 93.02 socket	solid wire	stranded wire	
	mm ²	1x6 / 2x2.5	1x4 / 2x2.5
	AWG	1x10 / 2x14	1x12 / 2x14

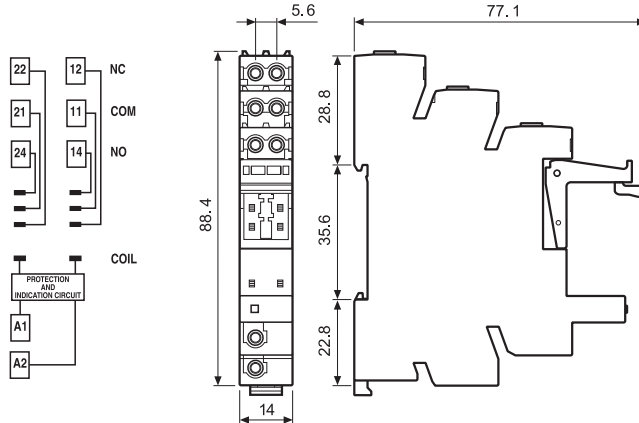



93.52

Approvals
(according to type):

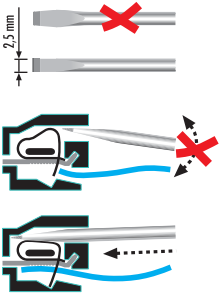

Screwless terminal socket 35 mm (EN 60715) mounting

Supply voltage	Relay type	Socket type
6 V AC/DC	41.52.9.005.0010	93.52.0.024
12 V AC/DC	41.52.9.012.0010	93.52.0.024
24 V AC/DC	41.52.9.024.0010 or 41.81.7.024.xxxx	93.52.0.024
60 V AC/DC	41.52.9.060.0010	93.52.0.060
(110...125)V AC/DC	41.52.9.110.0010	93.52.0.125
(220...240)V AC/DC	41.52.9.110.0010	93.52.0.240
(230...240)V AC	41.52.9.110.0010	93.52.8.230
6 V DC	41.52.9.005.0010	93.52.7.024
12 V DC	41.52.9.012.0010 or 41.81.7.012.xxxx	93.52.7.024
24 V DC	41.52.9.024.0010 or 41.81.7.024.xxxx	93.52.7.024
48 V DC	41.52.9.048.0010	93.52.7.060
60 V DC	41.52.9.060.0010	93.52.7.060

Accessories

8-way jumper link	093.08 (see table below)
Plastic separator	093.01 (see table below)
Sheet of marker tags, 72 tags	090.72 (see table below)

Technical data

Rated values	10 A - 250 V	
Dielectric strength	6 kV (1.2/50 μs) between coil and contacts	
Protection category	IP 20	
Ambient temperature	°C (-40...+70)°C - (U _N ≤ 60 V DC), (-40...+55)°C - (U _N > 60 V DC)	
Wire strip length	mm	8
Max. wire size for 93.52 socket	solid wire	stranded wire
	mm ²	1x2.5
	AWG	1x14

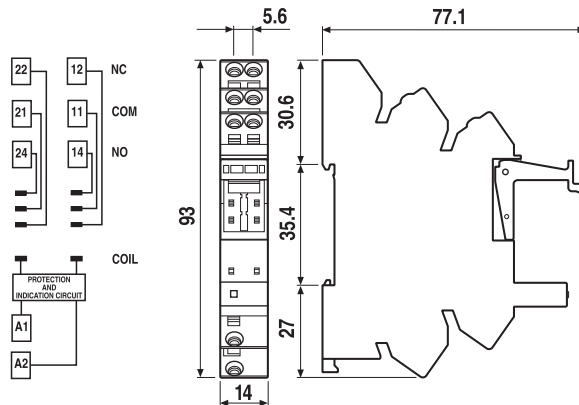

Accessories

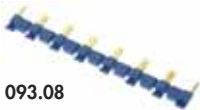

093.08

Approvals
(according to type):



8-way jumper link for 93.02 and 93.52 sockets	093.08 (blue)	093.08.0 (black)
Rated values	10 A - 250 V	

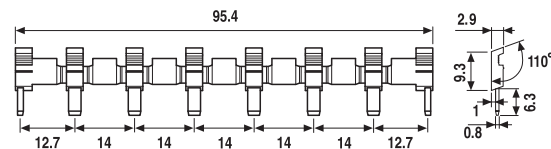

093.01

Plastic separator for 93.02 and 93.52 sockets	093.01
------------------------------------------------------	--------

Thickness 2 mm, required at the start and the end of a group of interfaces.

Can be used for visual separation group, must be used for:

- protective separation of different voltages of neighbouring PLC interfaces according to VDE 0106-101
- protection of cut jumper links

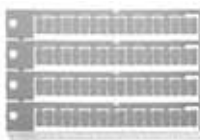

060.72

Sheet of marker tags for 38.x2, plastic, 72 tags, 6x12 mm	060.72
------------------------------------------------------------------	--------



95.13.2



95.15.2

Approvals
(according to type):



PCB socket	95.13.2 (blue)	95.13.20 (black)	95.15.2 (blue)	95.15.20 (black)
For relay type	41.31		41.52, 41.61, 41.81 ⁽¹⁾	
Accessories				
Plastic retaining clip				095.42
Technical data				
Rated values	10 A - 250 V *			
Dielectric strength	6 kV (1.2/50 μs) between coil and contacts			
Protection category	IP 20			
Ambient temperature	°C -40...+70			

* For currents >10 A, contact terminals must be connected in parallel (21 with 11, 24 with 14, 22 with 12).

⁽¹⁾ With the relay 41.81 the NO change-over contact will be 11-14.

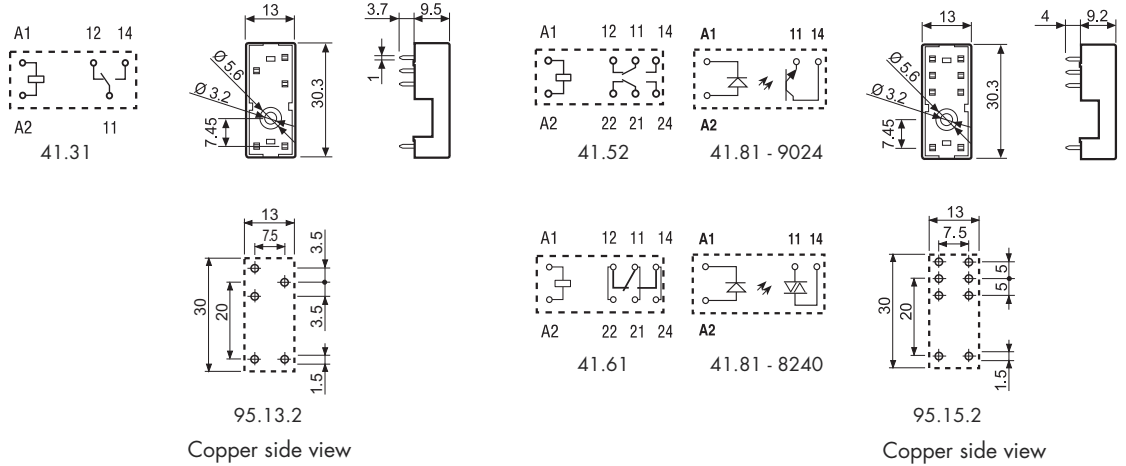

Packaging codes

How to code and identify retaining clip and packaging options for sockets.

Example:



A Standard packaging

SL Plastic retaining clip



Without retaining clip

X-ON Electronics

Largest Supplier of Electrical and Electronic Components

Click to view similar products for [Solid State Relays - Industrial Mount](#) category:

Click to view products by [Finder](#) manufacturer:

Other Similar products are found below :

[6225XXASRS-DC3](#) [D2440-C](#) [H10CA4890](#) [D4875C](#) [D53TP50DH-10](#) [1395831-1](#) [1616010-6](#) [BR312BY](#) [A-1326](#) [AQY210SXE01](#)
[AQY221N2SYD01](#) [AQY414SXE01](#) [26532764](#) [H10CA4850](#) [H12CA4890VL](#) [RA2410-D06](#) [D1202F](#) [D53TP50-10](#) [W230E-1-12](#) [W230T-3-](#)
[12](#) [W6125ASX-1](#) [W6225DSX-2](#) [W6240DSX-4](#) [W6240DTX-2](#) [1-1617030-3](#) [1-1617033-9](#) [1-1617033-7](#) [MS2-D2420](#) [MS2-D2430](#) [A-1440](#)
[4-1617080-0](#) [RJ1P60V50E](#) [RN1F48I50](#) [70.362.1028.0](#) [7-1393030-8](#) [Z5.509.0828.0](#) [W230E-2-5](#) [G3RV-SR700-D](#) [AC110](#) [G3RV-SR500-AL](#)
[AC100](#) [G3RV-SR500-D](#) [ACDC24](#) [G3RV-SR500-AL](#) [ACDC24](#) [G3RV-SR700-D](#) [ACDC24](#) [G3RV-SR700-AL](#) [ACDC24](#) [G3RV-SR500-D](#)
[DC12](#) [G3RV-SR700-A](#) [ACDC24](#) [G3RV-SR500-A](#) [ACDC24](#) [2912138](#) [2912141](#) [SSRDAC10](#) [1613353](#)