

## RMQ Titan Description



### Aesthetics and functionality

Attractive looks and practical operation – this combination is exemplified by industrial design from Moeller. The new RMQ Titan Control Circuit Devices program underscores this claim. The titanium-coloured front ring lends the program its name – and offers the devices and systems in a modern package with numerous application advantages. Naturally, RMQ Titan Control Circuit Devices are designed for worldwide application. They comply with all relevant international standards such as IEC/EN 60 947 as well as certification requirements and guidelines such as UL and CE. The high IP 66 degree of protection permits use in rugged industrial applications. The program is therefore extremely flexible.

### Practical orientation that pays off

The ergonomic design of the new control circuit devices pays dividends in daily use. Button elements, for instance, are correctly shaped for the fingertips. Indicator lights are fitted with specially developed lenses which guarantee perfect illumination.

### Colours speak louder than words

A clear colour signal replaces long explanations. Specified colours are assigned commands and meanings which are internationally understood. The illuminated operating elements and Indicator lights clearly display these colours even in darkness or distraction from other lights. To prevent yellow light from filament bulbs interfering with the lens colours, RMQ Titan Control Circuit Devices are provided with LEDs in red, green, white and also blue, when required.

### LEDs – dependable, economical lighting elements

LEDs require less current and thus produce less heat than filament bulbs. They also have no thin little wires that often burn through after a time or break due to shock or vibration. In fact, LEDs are completely vibration-proof and they function 100,000 hours non-stop with no loss of signal data. With no chance of sudden outages, device monitoring is best ensured.



### 11.5 years non-stop – a far-sighted decision

100,000 operating hours corresponds to 11.5 years in constant operation. After this length of time, RMQ Titan LED elements do not simply go out – their illumination intensity has simply dropped by half. Replacing a lamp is just as superfluous as planning and wiring a new lamp circuit. Even ordering is simplified since the LED and holder are delivered as a complete unit. With two voltage ranges from 18 – 30 VAC/DC and 85 – 264 V AC, all common applications are covered. Storage requirements are thus reduced considerably as well.



LED – illuminating the future for control circuit devices

## RMQ Titan Description



### RMQ Titan sheds light on all processes

Whether in the control panel or, for example, in suspension panels, signals are securely transmitted with RMQ Titan. The new illuminated emergency stop button has an integrated indicator light. This safety component is thus highly visible even in darkened rooms, eliminating the need for a separate indicator light. Important alarms can now be further reinforced by a warning tone: the buzzer in the RMQ Titan program ensures that a danger will be more quickly recognized by sounding a piercing, continuous tone.

### Special buttons for special demands

Especially dangerous production processes require not only the full concentration of service personnel but also special operating elements. Control devices – mushroom actuators with large button surfaces, for example – provide more security because their shape contrasts with other operating elements and they can also be easily pressed when wearing gloves. Key-operated actuators ensure that certain functions can only be controlled by specialist personnel. These actuators are especially space-saving with RMQ Titan whereby assembled height has been reduced by 50 %.

The double push-button actuators combine up to three functions in one mounting location. An integrated indicator light, for example, is thus optional. For especially rugged industrial applications, individual actuators can be protected from dust, flour, cement, etc. with diaphragms. The special form of actuator diaphragm and the high IP 67 degree of protection also permits application in food industries, in which machines must be frequently cleaned.

### Flexibility for individual mounting

RMQ Titan fits into the 22.3 mm standard bore. Up to six contact elements can be snapped on in two levels behind the front. The actuators have become more flush and mounting depth optimized overall. Therefore, a simple switch can now fit into standard commercial wall outlets.

As customary, three mounting styles are possible: flush, surface, and rear. On surface mounting enclosures, the fixing adapter is already integrated into the bottom of the enclosure. Telescopic clips are provided for use in control panels to adjust varying panel depths.

### Made-to-measure symbols and text

All button plates, indicator lights and additional button plates from the RMQ Titan Control Circuit Devices program can be supplied with any text and symbols. The information is etched by laser and will remain permanently – in contrast to printed elements. Additional button plates can also be engraved, in addition to laser printing.

### Stay-put or spring-return – simple to convert



All RMQ Titan stay-put push-button actuators can be set to stay-put or spring-return functions from the side. This pays off, for example, when a jog function is needed during set-up but the actuator is to later remain stay-put. A metal ring is visible from the side when the button is pressed halfway - a simple push converts the function.

And what applies to the push-button actuators also applies to all selector switches. The switching behaviour (spring-return/stay-put) and the withdrawal option for the key can be modified at any time and adapted to the application at hand. Ordering and storage are thus considerably reduced.



















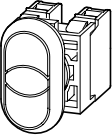

# RMQ Titan

## System Overview

<b>Emergency-Stop actuators</b>	1	<b>Enclosures</b>	5	<b>Selector switch actuators</b>	11
Tamper-proof to ISO 13 850/EN 418		IP 66 surface mounting enclosure up to 6 locations		Two or three positions	
Can be secured by means of sealable shroud		IP 54 flush mounting panel up to 6 locations		With rotary head, thumb-grip handle	
Additional plates with and without text		IP 40 shrouds for flush mounting plates		Programmable spring-return/stay-put function	
  		→ Page 27		Illuminated selector switch actuators with transparent thumb-grip	
BG classification applied for				Colours: white, green, red, yellow, blue	
→ Page 9		<b>Telescopic clips</b>	6	→ Page 15	
		For adjusting the depth of rear mounting devices in CI enclosures, CI-K4 enclosures and panels		<b>Button plates/button lenses</b>	12
<b>Label mounts</b>	2	→ Page 29		Laser-engraved text for push-button actuators and mushroom actuators	
For insert plates				Button lenses for illuminated push-button actuators and indicator lights, flush	
Colour: black		<b>Centring adapter</b>	7	With standard text and symbols or individual text	
Insert plates aluminium-coloured, with and without text, can be engraved		For centring of actuators and indicators when using telescopic clips		→ Page 26	
→ Page 25		→ Page 29		<b>Push-button actuators</b>	13
<b>Fixing adapter</b>	3	<b>IVS top-hat rail adapter</b>	8	Spring-return and stay-put	
For front fixing		For direct mounting to top-hat rail to EN 50 022		Flush and extended	
For contact and LED elements		→ Page 29		With and without guard ring	
→ Page 22		<b>Indicator lights</b>	9	Mushroom actuators	
<b>Contact elements</b>	4	Flush and conical versions		Double actuators	
Break and make		Colours: white, green, red, yellow, blue		Colour: white, green, red, yellow, blue, black	
Universal contacts suitable for use with electronic devices		→ Page 18		Illuminated push-button actuators	
Positive opening safety function to IEC/EN 60 947-5 -1		<b>Key-operated actuators</b>	10	Colour: white, green, red, yellow, blue	
→ Page 22		Two or three positions		→ Page 11	
<b>LED elements</b>	4	Programmable spring-return/stay-put function and key withdrawal		<b>Product features</b>	
Voltage range:		Suitable for master key systems		• Snap-fitting modular system	
18 – 30 V DC		→ Page 16		• Front ring in titanium or black	
85 – 264 V AC				• Mounting diameter: 22.3 mm	
→ Page 23				• Minimum grid spacing 30 ×40 mm	
				• IP 66 degree of protection	
				• Up to 6 contacts per location	
				• Switching of different potentials	
				• Approved throughout the world	

## RMQ Titan

### Complete Units for Front Mounting, Front IP 66

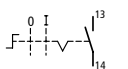
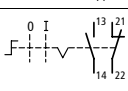
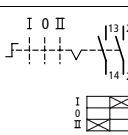
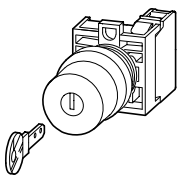
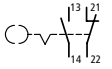















				Front ring titanium		
Button plate	Contacts <sup>1)</sup> M = Make, B = Break, ⊕ = Positive opening safety function to IEC/EN 60 947-5-1			Type Article no.	Price See Price List	Std. pack
<b>Push-button actuators</b>						
Flush 		1 M –		<b>M22-D-G-X1/K10</b> 216512		5 off
		– 1 B ⊕		<b>M22-D-R-X0/K01</b> 216510		
		1 M 1 B ⊕		<b>M22-D-G-X1/K11</b> 216513		
		1 M 1 B ⊕		<b>M22-D-R-X0/K11</b> 216511		
<b>Double push-buttons</b>						
Cover plate, black 		1 M –		<b>M22-DD-GR-X1/X0/K11</b> 216506		5 off
		– 1 B ⊕				
With LED element Lens assembly, white 85 – 264 V AC		1 M –		<b>M22-DDL-GR-X1/X0/K11/230-W</b> 216509		5 off
		– 1 B ⊕				
<b>Selector switch actuator, black thumb-grip handle</b>						
Stay-put/spring-return function can be changed using M22-XC-. coding adapters						
Two positions, stay-put 		1 M –		<b>M22-WRK/K10</b> 216518		5 off
		1 M 1 B ⊕		<b>M22-WRK/K11</b> 216519		
		2 M –		<b>M22-WRK3/K20</b> 216520		
<b>Key-operated actuator, with 1 key</b>						
Stay-put/spring-return function and key withdrawal can be changed with M22-XC-. coding adapter						
Two positions, stay-put MS 1 lock mechanism 		1 M 1 B ⊕		<b>M22-WRS/K11</b> 216517		5 off

**Notes**

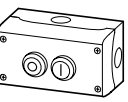
<sup>1)</sup> Special versions can be supplied as complete units for orders of 50 or more.  
Switch positions 0, I, II correspond to the position of the actuating element viewed from the front.

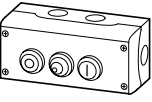
# RMQ Titan

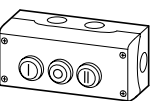

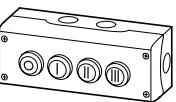
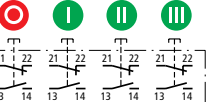































## Complete Units for Surface Mounting, IP 66

						Front ring titanium	
	Number of locations	Contacts <sup>1)</sup> M = Make, B = Break, ⊕ = Positive opening safety function to IEC/EN 60 947-5-1		Colour <sup>2)</sup> Enclosure top	Type Article no.	Price See Price List	Std. pack
<b>Push-button actuators</b>							
Flush 	1	1 M 1 B ⊕		Grey	M22-D-G-X1/KC11/I 216522		2 off
	1	1 M 1 B ⊕		Grey	M22-D-G-X0/KC11/I 216521		2 off
<b>Key-release mushroom buttons<sup>2)</sup></b>							
With 1 key MS 1 lock mechanism 	1	1 M 1 B ⊕		Yellow	M22-PVS/KC11/IY 216523		2 off
With 1 key, Two positions, stay-put MS 1 lock mechanism 	1	1 M 1 B ⊕		Grey	M22-WRS/KC11/I 216526		2 off
<b>Enclosures</b>							
With contact elements Without actuator 	1	1 M 1 B ⊕		Grey	M22-I1-M1 216527		2 off
	1	1 M 1 B ⊕		Yellow	M22-I1Y-M1 216528		2 off
Two-way push-button station 	2	2 M 2 B ⊕		Grey	M22-I2-M1 216529		2 off
Two-way push-button station With indicator light LED element 85 – 264 V AC 	2	2 M 2 B ⊕		Grey	M22-I3-M2 216533		1 off
Three-way push-button station 	3	3 M 3 B ⊕		Grey	M22-I3-M1 216532		1 off
Four-way push-button station 	4	4 M 4 B ⊕		Grey	M22-I4-M1 216534		1 off

















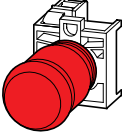

### Notes

- Special versions can be supplied as complete units for orders of 50 or more.  
Switch positions 0, I, II correspond to the position of the actuating element viewed from the front.
- grey = RAL 7035  
yellow = RAL 1004

## RMQ Titan Double Actuators

	Button plate version	Front ring titanium	Front ring black	Price See Price List	Std. pack
		Type Article no.	Type Article no.		
<b>Double actuators, IP 65</b>					
Without indicator light, Cover plate, black  		M22-DD-GR-X1/X0 216685	M22S-DD-GR-X1/X0 216686		5 off
					
		M22-DD-WS-X1/X0 216691	M22S-DD-WS-X1/X0 216692		
					
		M22-DD-GR-GB1/GB0 216687	M22S-DD-GR-GB1/GB0 216688		
					
		M22-DD-WS-GB1/GB0 216693	M22S-DD-WS-GB1/GB0 216694		
					
		M22-DD-S-X7/X7 216695	M22S-DD-S-X7/X7 216696		
					
		M22-DD-S-X4/X5 218143	M22S-DD-S-X4/X5 218144		
					
		M22-DD-GR 216683	M22S-DD-GR 216684		
					
	M22-DD-WS 216689	M22S-DD-WS 216690			
					
With indicator light, Lens assembly, white  		M22-DDL-GR-X1/X0 216700	M22S-DDL-GR-X1/X0 216701		5 off
					
		M22-DDL-WS-X1/X0 216706	M22S-DDL-WS-X1/X0 216707		
					
		M22-DDL-GR-GB1/GB0 216702	M22S-DDL-GR-GB1/GB0 216703		
					
		M22-DDL-WS-GB1/GB0 216708	M22S-DDL-WS-GB1/GB0 216709		
					
		M22-DDL-S-X7/X7 216710	M22S-DDL-S-X7/X7 216711		
					
		M22-DDL-S-X4/X5 218145	M22S-DDL-S-X4/X5 218146		
					
		M22-DDL-GR 216698	M22S-DDL-GR 216699		
					
	M22-DDL-WS 216704	M22S-DDL-WS 216705			
					

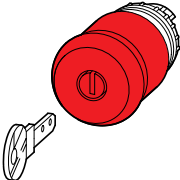
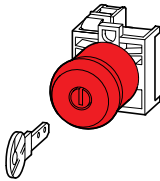
## RMQ Titan Emergency-Stop Actuators

		Contacts M = Make, B = Break, ⊕ = Positive opening safety function to IEC/EN 60 947-5-1	Colour: Enclosure top, yellow  Plunger <sup>1)</sup>	Type Article no.	Price See Price List	Std. pack
<b>Complete units for surface mounting, IP 66</b>						
Emergency-Stop actuator, tamper-proof to ISO 13 850/EN 418 Pull to release Max. configuration: 3 × M22-(C)K...						
   	1 M 1 B		●	M22-PV/KC11/I 216525		2 off
	- 2 B		●	M22-PV/KC02/I 216524		2 off
<b>Complete units for front mounting, IP 66</b>						
Emergency-Stop actuator, tamper-proof to ISO 13 850/EN 418 Pull to release Max. configuration: 4 × M22-(C)K...						
  	- 1 B ⊕		●	M22-PV/K01 216515		5 off
	1 M 1 B ⊕		●	M22-PV/K11 216516		5 off
Emergency-stop actuator Non-illuminated						
  	- -	-	●	M22-PV 216876		10 off
	- -	-	●	M22-PV-GVP 216877		50 off
Emergency-stop actuator Illuminated						
  	- -	-	●	M22-PVL 216878		5 off
<b>Emergency-Stop key-operated actuators IP 66</b>						
With 1 key						
	Individual lock mechanism MS 1	- -	-	●	M22-PVS 216879	5 off
	Individual lock mechanism MS 2 – 20	- -	-	●	M22-PVS-MS* 216880	1 off
<b>Emergency-stop key-operated mushroom actuator to ISO 13 850/EN 418</b>						
With 1 key, Individual lock mechanism MS 1						
	- 1 B ⊕		●	M22-PVS/K01 216514		5 off



Notes

<sup>1)</sup> Red = RAL 3000



## RMQ Titan

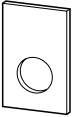
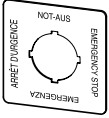





















### Emergency-Stop Labels, Sealable Shroud

	Text	Country code Explanation	Colour	Type Article no.	Price See Price List	Std. pack
<b>Emergency-stop labels, IP 66</b>						
Text black, 33 × 50 mm						
	Emergency-stop	D	●	M22-XZK-D99 216471		10 off
	Emergency Stop	GB		M22-XZK-GB99 216472		
	Arrêt d'urgence	F		M22-XZK-F99 216473		
	EMERGENZA	I		M22-XZK-I99 216474		
	NOODSTOP	NL		M22-XZK-NL99 216475		
	NÖDSTOPP	S		M22-XZK-S99 216476		
	HÄTÄ-SEIS	SF		M22-XZK-SF99 216477		
	NØDSTOP	DK		M22-XZK-DK99 216478		
	Blank	–		M22-XZK 216470		
	With individual text <sup>1)</sup>			M22-XZK- 216479		10 off
50 × 50 mm						
	Four-language	D, GB, F, I	●	M22-XYK1 216484		10 off
	Blank			M22-XAK 216464		10 off
Ø = 90 mm	Four-language	D, GB, F, I	●	M22-XAK1 216465		
	Four-language	D, GB, E, POR		M22-XAK2 216466		
	Four-language	D, GB, NL, F		M22-XAK3 216467		
	Four-language	GB, S, SF, DK		M22-XAK4 216468		
	With individual text			M22-XAK- 216469		
Ø = 60 mm						
	Four-language	D, GB, F, I		M22-XBK1 216483		
<b>Sealable shroud<sup>2)</sup></b>						
				M22-PL-PV 216397		2 off























**Notes**

- Height of letters: 5 mm  
Number of lines: Maximum 2  
characters per line: Maximum 7
- Transparent with collapse point, can be reused after an emergency stop.  
For use with M22-PV, M22-PVL, M22-PVS  
Adjacent holes should be sealed with M22(S)-B blanking plugs at 30 × 50 mm intervals.

























## RMQ Titan Push-Button Actuators

		Front ring titanium	Front ring black			
	Button plate	Type Article no.	Type Article no.	Price See Price List		
<b>Push-button actuators, IP 66</b>						
Flush, spring-return  		M22-D-S 216590	M22S-D-S 216591	10 off		
		M22-D-W 216592	M22S-D-W 216593			
		M22-D-R 216594	M22S-D-R 216595			
		M22-D-G 216596	M22S-D-G 216597			
		M22-D-Y 216598	M22S-D-Y 216599			
		M22-D-B 216600	M22S-D-B 216601			
	Without	M22-D-X 216602	M22S-D-X 216604			
	Without	M22-D-X-GVP 216603	–			
		M22-D-R-X0 216605	M22S-D-R-X0 216606			
		M22-D-G-X1 216607	M22S-D-G-X1 216608			
		M22-D-S-X0 216609	M22S-D-S-X0 216610			
		M22-D-W-X1 216611	M22S-D-W-X1 216612			
	Flush, stay-put   Programmable stay-put/spring-return function		M22-DR-S 216613		M22S-DR-S 216614	5 off
			M22-DR-W 216615		M22S-DR-W 216616	
		M22-DR-R 216617	M22S-DR-R 216618			
		M22-DR-G 216619	M22S-DR-G 216620			
		M22-DR-Y 216621	M22S-DR-Y 216622			
		M22-DR-B 216623	M22S-DR-B 216624			
Without		M22-DR-X 216625	M22S-DR-X 216627			
Without		M22-DR-X-GVP 216626	–			
		M22-DR-R-X0 216628	M22S-DR-R-X0 216629			
		M22-DR-G-X1 216630	M22S-DR-G-X1 216631			
		M22-DR-S-X0 216632	M22S-DR-S-X0 216633			
		M22-DR-W-X1 216634	M22S-DR-W-X1 216635			















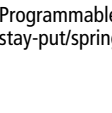









## RMQ Titan Push-Button Actuators

		Front ring titanium	Front ring black			
	Button plate	Type Article no.	Type Article no.	Price See Price List	Std. pack	
<b>Push-button actuators, IP 66</b>						
Extended, spring-return 		M22-DH-S 216636	M22S-DH-S 216637		5 off	
		M22-DH-W 216638	M22S-DH-W 216639			
		M22-DH-R 216640	M22S-DH-R 216642			
		M22-DH-G 216643	M22S-DH-G 216644			
		M22-DH-Y 216646	M22S-DH-Y 216647			
		M22-DH-B 216649	M22S-DH-B 216650			
		M22-DH-R-X0 216655	M22S-DH-R-X0 216656			5 off
		M22-DH-G-X1 216657	M22S-DH-G-X1 216658			
		M22-DH-S-X0 216659	M22S-DH-S-X0 216660			
		M22-DH-W-X1 216661	M22S-DH-W-X1 216662			
Extended, stay-put 		M22-DRH-S 216663	M22S-DRH-S 216664		5 off	
		M22-DRH-W 216665	M22S-DRH-W 216666			
		M22-DRH-R 216667	M22S-DRH-R 216668			
		M22-DRH-G 216669	M22S-DRH-G 216670			
		M22-DRH-Y 216671	M22S-DRH-Y 216672			
		M22-DRH-B 216673	M22S-DRH-B 216674			
		M22-DRH-R-X0 216675	M22S-DRH-R-X0 216676			5 off
		M22-DRH-G-X1 216677	M22S-DRH-G-X1 216678			
		M22-DRH-S-X0 216679	M22S-DRH-S-X0 216680			
		M22-DRH-W-X1 216681	M22S-DRH-W-X1 216682			
With guard ring, spring-return 	Without	M22-DG-X 220921	-			













## RMQ Titan Push-Button Actuators

	Button plate	Colour Mushroom	Front ring titanium	Front ring black	Price See Price List	Std. pack
			Type Article no.	Type Article no.		
<b>Mushroom actuators, IP 66</b>						
Spring-return 			M22-DP-S 216712	M22S-DP-S 216713		5 off
			M22-DP-R 216714	M22S-DP-R 216715		
			M22-DP-G 216716	M22S-DP-G 216717		
			M22-DP-Y 216718	M22S-DP-Y 216719		
			M22-DP-R-X0 216720	M22S-DP-R-X0 216721		5 off
			M22-DP-G-X1 216722	M22S-DP-G-X1 216723		
			M22-DP-S-X0 216724	M22S-DP-S-X0 216725		
			M22-DP-W-X1 216726	M22S-DP-W-X1 216727		
	Without		M22-DP-S-X 216728	M22S-DP-S-X 216730		5 off
	Without		M22-DP-R-X 216731	M22S-DP-R-X 216733		
	Without		M22-DP-G-X 216734	M22S-DP-G-X 216736		
	Without		M22-DP-Y-X 216737	M22S-DP-Y-X 216739		
	Without		M22-DP-S-X-GVP 216729	–		25 off
	Without		M22-DP-R-X-GVP 216732	–		
	Without		M22-DP-G-X-GVP 216735	–		
	Without		M22-DP-Y-X-GVP 216738	–		

## RMQ Titan Push-Button Actuators

				Front ring titanium	Front ring black	
Button plate	Colour Mushroom	Type Article no.	Type Article no.	Price See Price List	Std. pack	
<b>Mushroom actuators, IP 66</b>						
Stay-put 			M22-DRP-S 216743	M22S-DRP-S 216744		5 off
			M22-DRP-R 216745	M22S-DRP-R 216746		
Programmable stay-put/spring-return function 			M22-DRP-G 216747	M22S-DRP-G 216748		
			M22-DRP-Y 216749	M22S-DRP-Y 216750		
			M22-DRP-R-X0 216751	M22S-DRP-R-X0 216752		5 off
			M22-DRP-G-X1 216753	M22S-DRP-G-X1 216754		
			M22-DRP-S-X0 216755	M22S-DRP-S-X0 216756		
			M22-DRP-W-X1 216757	M22S-DRP-W-X1 216758		
Without		M22-DRP-S-X 216759	M22S-DRP-S-X 216761		5 off	
Without		M22-DRP-R-X 216762	M22S-DRP-R-X 216764			
Without		M22-DRP-G-X 216765	M22S-DRP-G-X 216767			
Without		M22-DRP-Y-X 216768	M22S-DRP-Y-X 216770			
Without		M22-DRP-S-X-GVP 216760	–		25 off	
Without		M22-DRP-R-X-GVP 216763	–			
Without		M22-DRP-G-X-GVP 216766	–			
Without		M22-DRP-Y-X-GVP 216769	–			

## RMQ Titan Selector Switches

			Front ring titanium		Front ring black		
Function			Type	Type	Price		
↳ = stay-put ▷ = spring-return			Article no.	Article no.	See Price		Std.
<b>Selector switch actuators, Two positions IP 66</b>							
Rotary head 	↳	40°		M22-W 216853	M22S-W 216854		5 off
	↳	60°		M22-WR 216855	M22S-WR 216856		
	↳	60°		M22-WR-X92 216857	M22S-WR-X92 216858		
	↳	60°	HAND AUTO 	M22-WR-X91 216859	M22S-WR-X91 216860		
Thumb-grip handle 	↳	40°	—	M22-WK 216865	M22S-WK 216866		
	↳	60°	—	M22-WRK 216867	M22S-WRK 216869		10 off
	↳	60°	—	M22-WRK-GVP 216868	—		50 off
Thumb-grip handle, V position	∨	60°	—	M22-WKV 216874	M22S-WKV 216875		5 off
<b>Selector switch actuators, Three positions IP 66</b>							
Rotary head 	40°	↔ 40°		M22-W3 216861	M22S-W3 216862		5 off
	60°	↔ 60°		M22-WR3 216863	M22S-WR3 216864		
Thumb-grip handle 	40°	↔ 40°	—	M22-WK3 216870	M22S-WK3 216871		
	60°	↔ 60°	—	M22-WRK3 216872	M22S-WRK3 216873		
	1)		—	M22-WRK3-* 217436	M22S-WRK3-* 217437		
<b>Coding adapters, for all selector switch actuators</b>							
For converting between stay-put and spring-return functions							
				M22-XC-Y 216407	M22S-XC-Y 216407		10 off

### Notes

1) Example: M22-WRK3-\*

└ 1 = 60° ↔ 40°  
 2 = 40° ↔ 60°

# RMQ Titan

## Key-Operated Actuators, Individual Lock Mechanisms

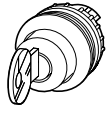
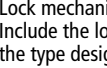
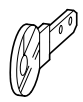
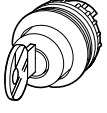
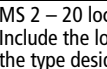
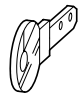
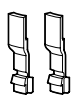
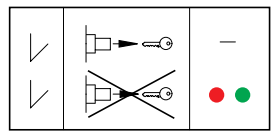
				Front ring titanium	Front ring black	
		Function	Key can be withdrawn in position	Type Article no.	Type Article no.	Price See Price List
		↳ = stay-put				
		↳ = spring-return				
<b>Key-operated actuators, IP 66</b>						
Two positions Individual lock mechanisms not suitable for master key systems, with 1 key Stay-put/spring-return function and withdrawable key facility can be changed with M22-XC coding adapters						
	MS 1 lock mechanism	↳ 40°	0	<b>M22-WS</b> 216881	<b>M22S-WS</b> 216882	1 off
		↳ 60°	0 I	<b>M22-WRS</b> 216887	<b>M22S-WRS</b> 216889	5 off
		↳ 60°	0 I	<b>M22-WRS-GVP</b> 216888	–	25 off
	Lock mechanism MS 2 – 20 <sup>1)</sup> Include the lock mechanism number in the type designation	↳ 40°	0	<b>M22-WS-MS*</b> 216883	<b>M22S-WS-MS*</b> 216884	1 off
		↳ 60°	0 I	<b>M22-WRS-MS*</b> 216890	<b>M22S-WRS-MS*</b> 216891	1 off
	Lock mechanism MS 1 – 20	↳ 50°	0	<b>M22-WRS-MS*-A1</b> 217440	<b>M22S-WRS-MS*-A1</b> 217441	5 off
	Key for MS 1 individual lock mechanism			<b>M22-ES-MS1</b> 216416	<b>M22-ES-MS1</b> 216416	5 off
	Key for MS 2 – 20 individual lock mechanisms			<b>M22-ES-MS*</b> 216417	<b>M22-ES-MS*</b> 216417	1 off
Three positions Individual lock mechanisms not suitable for master key systems, with 1 key Stay-put/spring-return function and withdrawable key facility can be changed with M22-XC coding adapters						
	MS 1 lock mechanism	40° ↕ 40°	0	<b>M22-WS3</b> 216894	<b>M22S-WS3</b> 216895	1 off
		60° ↕ 60°	I 0 II	<b>M22-WRS3</b> 216900	<b>M22S-WRS3</b> 216901	5 off
		60° ↕ 60°	I 0 II	<b>M22-WRS3-GVP</b> 216902	–	25 off
		2)	I 0	<b>M22-WRS3-MS*-A*</b> 217442	<b>M22S-WRS3-MS*-A*</b> 217443	5 off
	MS 2 – 20 lock mechanism Include the lock mechanism number in the type designation	40° ↕ 40°	0	<b>M22-WS3-MS*</b> 216896	<b>M22S-WS3-MS*</b> 216897	1 off
		60° ↕ 60°	I 0 II	<b>M22-WRS3-MS*</b> 216903	<b>M22S-WRS3-MS*</b> 216904	
	Key for MS 1 individual lock mechanism			<b>M22-ES-MS1</b> 216416	<b>M22-ES-MS1</b> 216416	
	Key for MS 2 – 20 individual lock mechanisms			<b>M22-ES-MS*</b> 216417	<b>M22-ES-MS*</b> 216417	
<b>Set of coding adapters</b>						
For converting between the stay-put/spring-return function and withdrawable key facility						
				<b>M22-XC-R</b> 216406	<b>M22-XC-R</b> 216406	10 off
				<b>M22-XC-Y</b> 216407	<b>M22-XC-Y</b> 216407	10 off

**Notes**

- 1) MS 2 – 20: 4 weeks delivery time
- 2) Example: M22(S)-WRS3-MS\*-A\*

	Function	can be withdrawn in switching position
A1	↕	0
A2	↳	I 0
A3	↕	0 II
A4	↳	I 0
A5	↕	0
A6	↳	0 II
A7	↕	0

↳ 1 – 20 (Individual lock mechanism no.)

# RMQ Titan

## Key-Operated Actuators for Master Key Systems

			Front ring titanium	Front ring black	
Function		Key can be withdrawn in position	Type Article no.	Type Article no.	Price See Price List
↳ = stay-put					
↳ = spring-return					
<b>Key-operated actuators IP 66<sup>1)</sup></b>					
Two positions, cannot be fitted with coding adapters with 2 keys <sup>2)</sup>	↳ 40°	0	M22-WS-SA(*)-* 216885	M22S-WS-SA(*)-* 216886	1 off
	↳ 60°	0	M22-WRS-SA(*)-* 216892	M22S-WRS-SA(*)-* 216893	
Three positions, cannot be fitted with coding adapters with 2 keys <sup>2)</sup>	↳ 40°	0	M22-WS3-SA(*)-* 216898	M22S-WS3-SA(*)-* 216899	
	↳ 60°	0	M22-WRS3-SA(*)-* 216905	M22S-WRS3-SA(*)-* 216906	
Standard key			M22-ES-SA(*)-* 217444	M22-ES-SA(*)-* 217444	

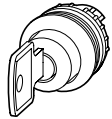
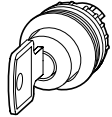

**Notes**

- 1) Master key systems: 6 – 8 weeks delivery time
  - 2) Example: M22-WS-SA(\*)-\* — Levels e. g. 2.3.1 — Standard key
    - ↳ Group master key
    - ↳ Master key
    - 0 = General master key
- for new orders = new  
For repeat orders = Master key system no. acc. security certificate

**Master key systems**

- 8000 different lock mechanisms
- Security certificate prevents unauthorized purchase of keys: enter with repeat orders
- Special key profile provided only by the manufacturer
- Moeller master key systems cannot be combined with domestic locks

**Lock plan**





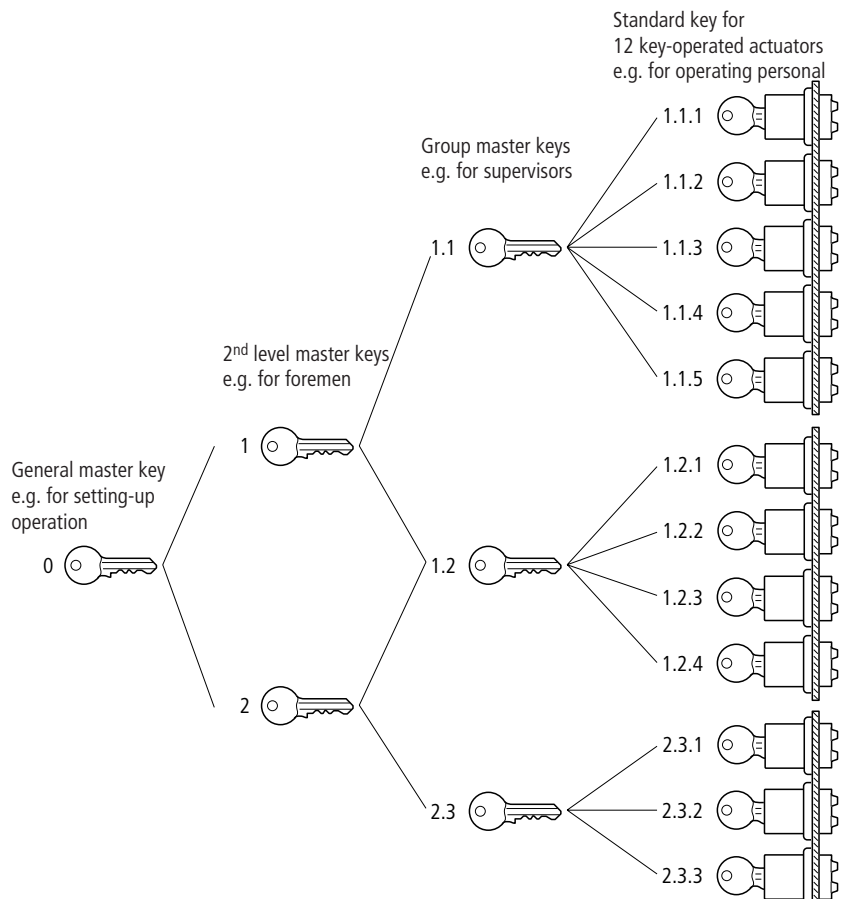







**Example of a GHS general master key system:**

The system consists of 12 individual locks and the associated different keys. At the first level the locks are combined to form 3 groups. For each of the 3 groups there is one master key that can open all locks in its groups. In the 2nd level, the 3 groups are combined to form 2 main groups, the 2nd level master keys can open all the locks from several groups. The general master key covers the 2 main groups can thus open all 12 locks of the master key system.











































## RMQ Titan Indicator Lights

		Front ring titanium		
	Actuator lens style	Type Article no.	Price See Price List	Std. pack
<b>Indicator light IP 66</b>				
<b>Flush</b>				
		M22-L-W 216771		10 off
		M22-L-R 216772		
		M22-L-G 216773		
		M22-L-Y 216774		
		M22-L-B 216775		
	Without lens	M22-L-X 216776		
	Without lens	M22-L-X-GVP 216777		50 off
<b>Extended</b>				
		M22-LH-W 216778		10 off
		M22-LH-R 216779		
		M22-LH-G 216780		
		M22-LH-Y 216781		
		M22-LH-B 216782		







## RMQ Titan Illuminated Push-Buttons

		Front ring titanium	Front ring black	
Actuator lens style		Type Article no.	Type Article no.	Price See Price List
				Std. pack
<b>Illuminated push-button actuators IP 66</b>				
Flush, spring-return  		M22-DL-W 216922	M22S-DL-W 216924	10 off
		M22-DL-R 216925	M22S-DL-R 216926	
		M22-DL-G 216927	M22S-DL-G 216928	
		M22-DL-Y 216929	M22S-DL-Y 216930	
		M22-DL-B 216931	M22S-DL-B 216932	
	Without	M22-DL-X 216933	M22S-DL-X 216935	
	Without	M22-DL-X-GVP 216934	–	50 off
		M22-DL-R-X0 216936	M22S-DL-R-X0 216937	10 off
		M22-DL-G-X1 216938	M22S-DL-G-X1 216939	5 off
		M22-DL-W-X1 216942	M22S-DL-W-X1 216943	
Flush, stay-put    Programmable stay-put/spring-return function		M22-DRL-W 216944	M22S-DRL-W 216945	5 off
		M22-DRL-R 216946	M22S-DRL-R 216947	
		M22-DRL-G 216948	M22S-DRL-G 216949	
		M22-DRL-Y 216950	M22S-DRL-Y 216951	
		M22-DRL-B 216952	M22S-DRL-B 216953	
	Without	M22-DRL-X 216954	M22S-DRL-X 216956	
	Without	M22-DRL-X-GVP 216955	–	50 off
		M22-DRL-R-X0 216957	M22-DRL-R-X0 216958	5 off
		M22-DRL-G-X1 216959	M22S-DRL-G-X1 216960	
		M22-DRL-W-X1 216963	M22S-DRL-W-X1 216964	

## RMQ Titan Illuminated Push-Buttons

		Front ring titanium	Front ring black	
Actuator lens style		Type Article no.	Type Article no.	Price See Price List
<b>Illuminated push-button actuators IP 66</b>				
Extended, spring-return  		M22-DLH-W 216965	M22S-DLH-W 216966	5 off
		M22-DLH-R 216967	M22S-DLH-R 216968	
		M22-DLH-G 216969	M22S-DLH-G 216970	
		M22-DLH-Y 216971	M22S-DLH-Y 216972	
		M22-DLH-B 216973	M22S-DLH-B 216974	
		M22-DLH-R-X0 216975	M22S-DLH-R-X0 216976	
		M22-DLH-G-X1 216977	M22S-DLH-G-X1 216978	
		M22-DLH-W-X0 216979	M22S-DLH-W-X0 216980	
		M22-DLH-W-X1 216981	M22S-DLH-W-X1 216982	
Extended, stay-put    Programmable stay-put/spring-return function		M22-DRLH-W 216788	M22S-DRLH-W 216791	5 off
		M22-DRLH-R 216789	M22S-DRLH-R 216792	
		M22-DRLH-G 216796	M22S-DRLH-G 216798	
		M22-DRLH-Y 216799	M22S-DRLH-Y 216801	
		M22-DRLH-B 216802	M22S-DRLH-B 216803	
		M22-DRLH-R-X0 216804	M22S-DRLH-R-X0 216808	
		M22-DRLH-G-X1 216805	M22S-DRLH-G-X1 216809	
		M22-DRLH-W-X0 216806	M22S-DRLH-W-X0 216810	
		M22-DRLH-W-X1 216807	M22S-DRLH-W-X1 216811	

# RMQ Titan Illuminated Selector Switch Actuators

				Front ring titanium	Front ring black	
		Function	Thumb-grip colour	Type	Type	Price
		↳ = stay-put		Article no.	Article no.	See Price List
		↳ = spring-return				Std. pack
<b>Illuminated selector switch actuators, thumb-grip handle IP 66</b>						
<b>Two positions</b>						
 Spring-return	↳	40°	○	M22-WLK-W 216812	M22S-WLK-W 216813	5 off
	↳	40°	●	M22-WLK-R 216814	M22S-WLK-R 216815	
	↳	40°	●	M22-WLK-G 216816	M22S-WLK-G 216817	
	↳	40°	●	M22-WLK-Y 216818	M22S-WLK-Y 216819	
	↳	40°	●	M22-WLK-B 216820	M22S-WLK-B 216821	
 Stay-put	↳	60°	○	M22-WRLK-W 216823	M22S-WRLK-W 216824	
	↳	60°	●	M22-WRLK-R 216825	M22S-WRLK-R 216826	
	↳	60°	●	M22-WRLK-G 216827	M22S-WRLK-G 216828	
	↳	60°	●	M22-WRLK-Y 216829	M22S-WRLK-Y 216830	
	↳	60°	●	M22-WRLK-B 216831	M22S-WRLK-B 216832	
<b>Three positions</b>						
 Spring-return	40°	↔	40°	○	M22-WLK3-W 216833	5 off
	40°	↔	40°	●	M22-WLK3-R 216835	
	40°	↔	40°	●	M22-WLK3-G 216837	
	40°	↔	40°	●	M22-WLK3-Y 216839	
	40°	↔	40°	●	M22-WLK3-B 216841	
 Stay-put	60°	↔	60°	○	M22-WRLK3-W 216843	
	60°	↔	60°	●	M22-WRLK3-R 216845	
	60°	↔	60°	●	M22-WRLK3-G 216847	
	60°	↔	60°	●	M22-WRLK3-Y 216849	
	60°	↔	60°	●	M22-WRLK3-B 216851	
Stay-put, spring-return <sup>1)</sup>	40°	↔	60°	M22-WRLK3-*/ 217438	M22S-WRLK3-*/ 216439	
<b>Coding adapters, for all selector switch actuators</b>						
For converting between stay-put and spring-return functions						
				M22-XC-Y 216407	M22-XC-Y 216407	10 off

**Notes**

<sup>1)</sup> Example: M22-WRLK3-\*/\*

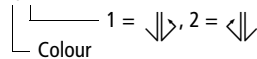

# RMQ Titan

## Fixing Adapters, Contact Elements

Contacts<sup>1)</sup>  
 M = Make, B = Break, ⊕ = Positive  
 opening safety function to  
 IEC/EN 60 947-5-1

Configuration<sup>2)</sup>

**Type**  
 Article no.

**Price**  
 See Price List

Std. pack

### Fixing adapter (front fixing)

for M22-K contact elements.  
 Sequence numbers on fixing adapter

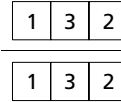
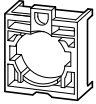

M22-A 216374	50 off
M22-A-GVP 216375	500 off

### Contact elements with screw terminals

Front fixing

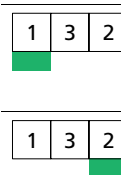
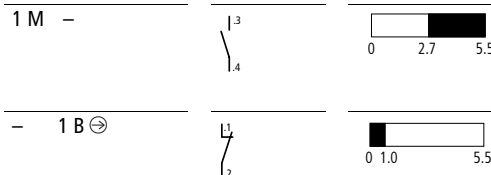
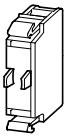

M22-K10 216376	50 off
M22-K10-GVP 216377	500 off
M22-K01 216378	50 off
M22-K01-GVP 216379	500 off

Base fixing

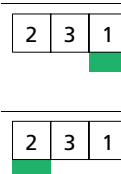
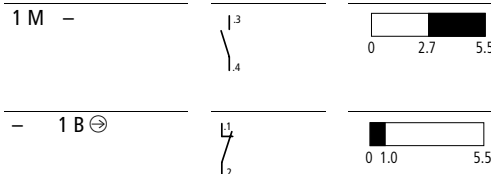
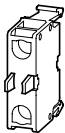

M22-KC10 216380	20 off
M22-KC10-GVP 216381	200 off
M22-KC01 216382	20 off
M22-KC01-GVP 216383	200 off

### Contact elements with cage clamp<sup>3)</sup>

Front fixing

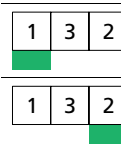
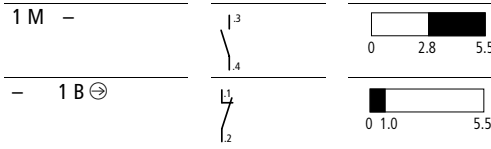
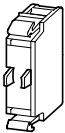

M22-CK10 216384	10 off
M22-CK01 216385	10 off

Base fixing

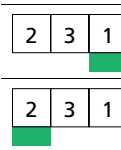
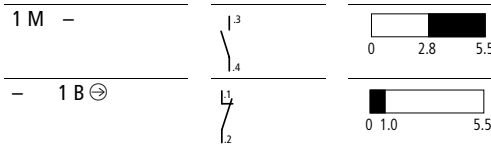
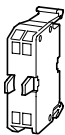

M22-CKC10 216386	10 off
M22-CKC01 216387	10 off

### Complete modules

Combination of contact element and fixing adapter,  
 Front fixing

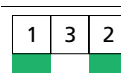
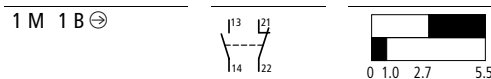
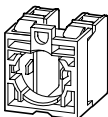

M22-AK11 216505	5 off
--------------------	-------

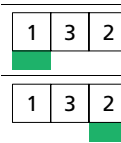
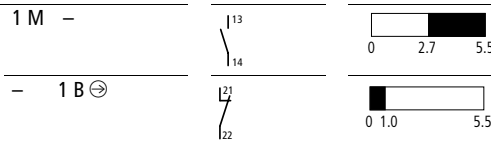
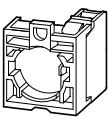



M22-AK10 216504	
M22-AK01 216503	

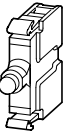
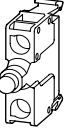
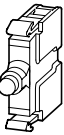

### Notes

- <sup>1)</sup>  $\begin{matrix} |_{xy} \\ |_{xy} \end{matrix}$  x = Sequence numbers on fixing adapter  
 y = Function numbers on contact element
- <sup>2)</sup> Configuration of fixing adapter with sequence numbers to EN 50 013
- <sup>3)</sup> Cage Clamp is a registered trademark of Wago Contact Technik GmbH, Minden

## RMQ Titan LED Elements

	Rated operational voltage	Rated operational current	Rated lifespan at $T_a = +25^\circ\text{C}$	Colour	Type Article no.	Price See Price List	Std. pack
<b>LED elements with screw terminals</b>							
<b>Front fixing</b>							
	18 – 30 V AC/DC	8 – 15 mA	100,000 h	○	M22-LED-W 216557		20 off
				●	M22-LED-R 216558		
				●	M22-LED-G 216559		
				●	M22-LED-B 218057		
<b>Base fixing</b>							
	18 – 30 V AC/DC	8 – 15 mA	100,000 h	○	M22-LEDC-W 216560		20 off
				●	M22-LEDC-R 216561		
				●	M22-LEDC-G 216562		
				●	M22-LEDC-B 218058		
<b>Front fixing</b>							
	85 – 264 V AC	5 – 15 mA	100,000 h	○	M22-LED230-W 216563		20 off
				●	M22-LED230-R 216564		
				●	M22-LED230-G 216565		
				●	M22-LED230-B 218059		
<b>Base fixing</b>							
	85 – 264 V AC	5 – 15 mA	100,000 h	○	M22-LEDC230-W 216566		20 off
				●	M22-LEDC230-R 216567		
				●	M22-LEDC230-G 216568		
				●	M22-LEDC230-B 218060		

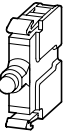
## RMQ Titan LED Elements

	Rated operational voltage	Rated operational current	Rated lifespan at $T_a = +25\text{ °C}$	Colour	Type Article no.	Price See Price List	Std. pack
<b>LED elements with Cage Clamp<sup>1)</sup></b>							
<b>Front fixing</b>							
	18 – 30 V AC/DC	8 – 15 mA	100,000 h	○	M22-CLED-W 216569		10 off
				●	M22-CLED-R 216570		
				●	M22-CLED-G 216571		
				●	M22-CLED-B 218061		
<b>Base fixing</b>							
	18 – 30 V AC/DC	8 – 15 mA	100,000 h	○	M22-CLEDC-W 216572		10 off
				●	M22-CLEDC-R 216573		
				●	M22-CLEDC-G 216574		
				●	M22-CLEDC-B 218062		
<b>Front fixing</b>							
	85 – 264 V AC	5 – 15 mA	100,000 h	○	M22-CLED230-W 216575		10 off
				●	M22-CLED230-R 216576		
				●	M22-CLED230-G 216577		
				●	M22-CLED230-B 218063		
<b>Base fixing</b>							
	85 – 264 V AC	5 – 15 mA	100,000 h	○	M22-CLEDC230-W 216578		10 off
				●	M22-CLEDC230-R 216579		
				●	M22-CLEDC230-G 216580		
				●	M22-CLEDC230-B 218064		

**Notes**

<sup>1)</sup> Cage Clamp is a registered trademark of Wago Contact Technik GmbH, Minden

## RMQ Titan



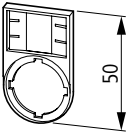
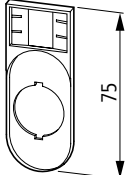

















### Label Mounts Complete, Insert Plates

	Type	Price	Std.
	Article no.	See Price List	pack
<b>Complete Legend Plates</b>			
30 × 50 mm, round, black			
0 I	M22S-ST-X88 216485		10 off
I 0 II	M22S-ST-X89 216486		
0 I	M22S-ST-X93 218147		
STOP	M22S-ST-GB0 216494		
START	M22S-ST-GB1 216495		
Aus	M22S-ST-D5 218299		
OFF	M22S-ST-GB5 218300		
Ein	M22S-ST-D6 216487		
ON	M22S-ST-GB6 216496		
Störung	M22S-ST-D8 216489		
FAULT	M22S-ST-GB8 216498		
Betrieb	M22S-ST-D7 216488		
RUN	M22S-ST-GB7 216497		
HAND AUTO	M22S-ST-D11 216492		
MAN. AUTO	M22S-ST-GB11 216500		
Aus Ein	M22S-ST-D10 216490		
OFF ON	M22S-ST-GB10 216499		
HAND 0 AUTO	M22S-ST-D12 216493		
MAN. 0 AUTO	M22S-ST-GB12 216501		
<b>Insert plates for label mounts, 18 × 27 mm</b>			
	Aluminium blank	M22-XST 216480	100 off
	Aluminium blank	M22-XST-GVP 216481	500 off
	With individual text	M22-XST-* 216482	1 off
			Letter height mm
			No. of lines max.
			Characters per line max.
			3
			3
			5
			2
			8
<b>Legend plates, without labels</b>			
Round, black, 30 mm wide			
	M22S-ST-X 216392		100 off
	M22S-ST-X-GVP 216393		500 off
For double actuators	M22S-STDD-X 216394		10 off
			



## RMQ Titan

### Button Plates, Button Lenses, Lenses

For use with	Colour	Style: Flush Type Article no.	Price See Price List	Style: Extended Type Article no.	Price See Price List	Std. pack
<b>Button plates, Push-button actuator</b>						
M22(S)-D-X M22(S)-DR-X		M22-XD-S 216421		M22-XDH-S 216428		1 off
		M22-XD-W 216422		M22-XDH-W 216429		
		M22-XD-R 216423		M22-XDH-R 216430		
		M22-XD-G 216424		M22-XDH-G 216431		
		M22-XD-Y 216425		M22-XDH-Y 216432		
		M22-XD-B 216426		M22-XDH-B 216433		
	With individual text <sup>1)</sup>	M22-XD-*. * 216427		M22-XDH-*. * 216434		
<b>Button lenses, Push-button actuator</b>						
M22(S)-DL-X M22(S)-DRL-X		M22-XDL-W 216441		M22-XDHL-W 216447		10 off
		M22-XDL-R 216442		M22-XDHL-R 216448		
		M22-XDL-G 216443		M22-XDHL-G 216449		
		M22-XDL-Y 216444		M22-XDHL-Y 216450		
		M22-XDL-B 216445		M22-XDHL-B 216451		
	With individual text <sup>1)</sup>	M22-XDL-*. * 216446		M22-XDHL-*. * 216452		1 off
<b>Button plates, Mushroom actuator</b>						
M22-L-X M22-LC-X		M22-XDP-S 216435		–		10 off
		M22-XDP-W 216436		–		
		M22-XDP-R 216437		–		
		M22-XDP-G 216438		–		
		M22-XDP-Y 216439		–		
	With individual text <sup>1)</sup>	M22-XDP-*. * 216440		–		1 off
<b>Lens, Indicator light</b>						
		M22-XL-W 216453		M22-XLH-W 216459		10 off
		M22-XL-R 216454		M22-XLH-R 216460		
		M22-XL-G 216455		M22-XLH-G 216461		
		M22-XL-Y 216456		M22-XLH-Y 216462		
		M22-XL-B 216457		M22-XLH-B 216463		
	With individual text <sup>1)</sup>	M22-XL-*. * 216458		–		1 off

## Notes

<sup>1)</sup> Example: M22-X...\*. \*.

Symbol (new or designator from library e. g. GB12)





Colour: e. g. -R, -G, -B, -W, -Y

Height of letters 3 mm: Max. 8 character in 1st line, 10 characters in 2nd line 8 characters in 3rd line

Height of letters 5 mm: Max. 5 characters in one line

## RMQ Titan

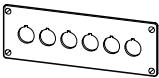

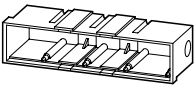
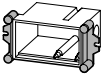







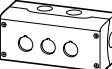

### Flush Mounting Plates, Shrouds

	Number of locations		Cable entry knockouts	Type Article no.	Price See Price List	Std. pack
	Number	Colour <sup>1)</sup>	Number × M20			
<b>Flush mounting panels IP 54</b>						
Legend plates cannot be used if push-buttons are fitted in vertical column Without apertures, if required						
						
Aluminium with yellow paint finish for Emergency-Stop buttons	1		–	<b>M22-EY1</b> 2165472		5 off
Aluminium, light anodized	1		–	<b>M22-E1</b> 216541		
	2		–	<b>M22-E2</b> 216543		
	3		–	<b>M22-E3</b> 216544		
	4		–	<b>M22-E4</b> 216545		1 off
	5		–	<b>M22-E5</b> 216546		
	6		–	<b>M22-E6</b> 216547		
						
<b>Shrouds, IP 40</b>						
Plastic, light grey						
	1		3	<b>M22-H1</b> 216548		1 off
	2		4	<b>M22-H2</b> 216549		
	3		4	<b>M22-H3</b> 216550		
	4		4	<b>M22-H4</b> 216551		
	5		5	<b>M22-H5</b> 216552		
	6		6	<b>M22-H6</b> 216553		
						
<b>Set of plaster keys</b>						
Consists of two plaster keys as an aid to flush mounting of shrouds in plaster						
	–	–	–	<b>M22-UPE</b> 216554		1 off

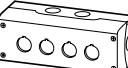
#### Notes

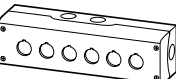
<sup>1)</sup> yellow RAL 1004,  
light gray RAL 7035

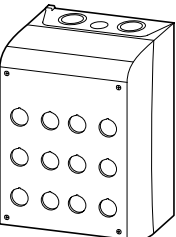







## RMQ Titan Surface Mounting Enclosures

	Number of locations	Cable entry knockouts		Colour <sup>1)</sup>	Type Article no.	Price See Price List	Std. pack
		Bottom	Sides:				
		Number	Number × M...				
<b>Surface mounting enclosure IP66</b> <small>totally insulated</small>							
With stainless steel screws							
For Emergency-Stop actuator	1	2 × 16	2 × 25/20 1 × 20		<b>M22-IY1</b> 216536		2 off
	1	2 × 16	2 × 25/20 1 × 20		<b>M22-I1</b> 216535		2 off
	2	2 × 16	1 × 20 2 × 25/20		<b>M22-I2</b> 216537		1 off
	3	2 × 16	2 × 25/20 2 × 20		<b>M22-I3</b> 216538		
	4	2 × 16	2 × 25/20 2 × 20		<b>M22-I4</b> 216539		
	6	2 × 16	2 × 25/20 2 × 20		<b>M22-I6</b> 216540		
<b>Surface mounting enclosure IP 65</b> <small>totally insulated</small>							
	12	2 × 32/25	4 × 32/25 2 × 20		<b>M22-I12</b> 222688		1 off





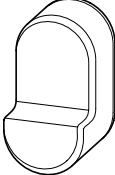
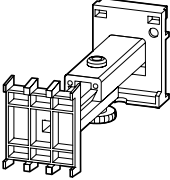
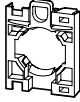
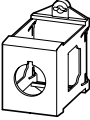







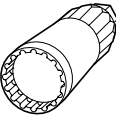
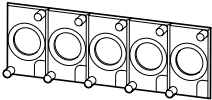

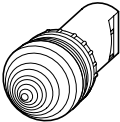

**Notes**

<sup>1)</sup> Colour: yellow RAL 1004, enclosure cover light grey RAL 7035, enclosure base anthracite RAL 9005

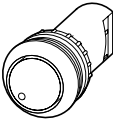
## RMQ Titan Accessories

For use with	Colour	Type Article no.	Price See Price List	Std. pack
<b>Blanking plugs, IP 66</b>				
For blanking off reserve locations				
Round design				
		<b>M22S-B</b> 216390		50 off
		<b>M22S-B-GVP</b> 216391		250 off
		<b>M22-B</b> 216388		50 off
		<b>M22-B-GVP</b> 216389		250 off
<b>Actuator diaphragms for IP 67</b>				
Transparent diaphragms for severe environmental conditions and use in the food industry. Do not use with label mounts since degree of protection is not guaranteed				
		Push-button actuators M22(S)-D(R)-... Illuminated push-button actuators M22(S)-DL-..., M22(S)-DRL-... Indicator light, flush M22(S)-L(C)-...	<b>M22-T-D</b> 216395	10 off
		Double actuators M22(S)-DD(L)-...	<b>M22-T-DD</b> 216396	10 off
<b>Telescopic clip</b>				
For adjusting depth of rear mounting devices in CI enclosures and panels with a mounting depth of 125 – 157mm. Stepless adjustment from 64 – 95 mm, screw and snap fastener. Maximum of 10 × M22-TC per CI enclosure, five of which can hold stay-put actuators. Do not use with Emergency-Stop actuators.				
			<b>M22-TC</b> 216398	10 off
<b>Centring adapter</b>				
for use with M22-TC telescopic clips				
			<b>M22-ZA</b> 216399	10 off
<b>IVS top-hat rail adapter</b>				
For front fixing				
			<b>M22-IVS</b> 216400	1 off
<b>Plunger bridge</b>				
For medium contact (1 piece), black				
			<b>M22-XW</b> 216405	10 off

## RMQ Titan Accessories

	For use with	Colour	Type Article no.	Price See Price List	Std. pack	
<b>Threaded ring</b> M22 × 1,5 mm 			M22-GR 216401		50 off	
			M22-GR-GVP 216404		500 off	
<b>Adapter ring set 30/22.5 mm</b> Black, consisting of adapter ring and lock nut 	for mounting of $\varnothing$ 22.5 units in $\varnothing$ 30.5 holes		M22S-R30 216408		10 off	
<b>Combination box spanner</b> 	For front ring and lock nuts as well as illuminated actuator lens assemblies	–	M22-MS 216402		5 off	
<b>Fixing plate</b> 	For fixing shrouds (M22-H...) to M22-E... flush mounting panel, for 5 locations		M22-XE5 218945		1 off	
<b>Indicator light, compact IP 66</b> Flush, with BA 9s lamp socket 			M22-LC-W 216907		10 off	
			M22-LC-R 216908			
			M22-LC-G 216909			
			M22-LC-Y 216910			
			M22-LC-B 216911			
		Without lens	M22-LC-X 216912			
	Extended, with BA 9s lamp socket 			M22-LCH-W 216914		
				M22-LCH-R 216915		
				M22-LCH-G 216916		
				M22-LCH-Y 216917		
		M22-LCH-B 216918				
<b>Acoustic indicator, IP 40</b> Front black incl. buzzer 18 – 30 V DC			M22-AM 216913		10 off	
<b>Bulb extractor</b> 	for compact indicator light M22-LC(H)...	–	M22-LG 216403		5 off	

# RMQ Titan

## Technical Data

				Contact elements	LED elements	Push-button actuators Mushroom actuators	Double actuators	Selector switch actuators Illuminated selector actuators
<b>General</b>								
Standards				IEC/EN 60 947, VDE 0660				
Lifespan, mechanical	Operations	$\times 10^6$	10	–	5	0.2	0.1	
Maximum operating frequency		Ops/h	3600	–	3600	3600	2000	
Operating force		N	$\leq 5$	–	$\leq 5$	$\leq 5$	–	
Operating torque		Nm	–	–	–	–	$\leq 0,3$	
Degree of protection to IEC/EN 60 529			IP 20	IP 20	IP 66	IP 66	IP 66	
Climatic proofing				Damp heat, constant, to IEC 60 068-2-3 Damp heat, cyclical, to IEC 60 068-2-30				
Ambient temperature								
	Min./Max.	$^{\circ}\text{C}$	–25/+70	–25/+70 <sup>1)</sup>	–25/+70	–25/+70	–25/+70	
Mounting position				As required				
Mechanical shock resistance (shock duration 11 ms) to IEC 60 068-2-27				g				
			> 30	> 30	> 30	> 30	> 30	
Terminal capacity								
Solid	Min./Max.	mm <sup>2</sup>	0.75/2.5	0.75/2.5	–	–	–	
Stranded	Min./Max.	mm <sup>2</sup>	0.5/1.5	0.5/1.5	–	–	–	
Dimensions				→ Page 34	–	→ Page 33	→ Page 33	→ Page 33
<b>Contacts</b>								
Rated impulse withstand voltage $U_{\text{imp}}$				V	6000	4000	–	–
Rated insulation voltage $U_i$				V	500	250	–	–
Overvoltage category/pollution degree				III/3	III/3	–	–	–
Control circuit reliability at								
24 V DC/5 mA	Fault probability $H_F$		< $10^{-7}$ , < 1 fault in $10^7$ operations					
5 V DC/1 mA	Fault probability $H_F$		> $\times 10^{-6}$ , < 1 fault in $5 \times 10^6$ operations					
Max. short-circuit protective device								
Fuseless	Type		PKZM0–10/ FAZ-B6	–	–	–	–	
Fuse	A gL/gG		10	–	–	–	–	
<b>Switching capacity</b>								
Rated operational current $I_e$								
AC-15	115 V	A	6	–	–	–	–	
	230 V	A	6	–	–	–	–	
	400 V	A	4	–	–	–	–	
	500 V	A	2	–	–	–	–	
DC-13	24 V	A	3	–	–	–	–	
	42 V	A	1.7	–	–	–	–	
	60 V	A	1.2	–	–	–	–	
	110 V	A	0.8	–	–	–	–	
	220 V	A	0.3	–	–	–	–	
Lifespan, electrical								
AC-15	230 V/0.5 A	Operations	$\times 10^6$	1.6	–	–	–	
	230 V/1.0 A	Operations	$\times 10^6$	1.0	–	–	–	
	230 V/3.0 A	Operations	$\times 10^6$	0.7	–	–	–	
DC-13	12 V/2.8 A	Operations	$\times 10^6$	1.2	–	–	–	

**Notes**

1) &gt; 200 V AC/60 Hz: –25/+55 °C

## RMQ Titan

### Technical Data

				Key-operated actuators	Indicator lights	Illuminated push-button actuators, Push-button actuators Mushroom actuators Stay-put	Emergency-Stop actuators
<b>General</b>							
Standards				IEC/EN 60 947, VDE 0660			
Lifespan, mechanical	Operations	$\times 10^6$		0.1	–	3 <sup>2)</sup>	0.1
Maximum operating frequency		Ops/h		100	–	1800	600
Operating force		N		–	–	$\leq 5$	$\leq 50$
Operating torque		Nm		$\leq 0.5$	–	–	–
Degree of protection to IEC/EN 60 529				IP 66	IP 66	IP 66	IP 66
Climatic proofing				Damp heat, constant, to IEC 60 068-2-3 Damp heat, cyclical, to IEC 60 068-2-30			
Ambient temperature							
	Min./Max.	°C		–25/+70	–25/+70	–25/+70	–25/+70
Mounting position				As required	As required	As required	As required
Mechanical shock resistance (shock duration 11 ms) to IEC 60 068-2-27				g	> 30	> 30	> 50
Terminal capacity							
Solid	Min./Max.	mm <sup>2</sup>		–	–	–	–
Stranded	Min./Max.	mm <sup>2</sup>		–	–	–	–
Dimensions				→ Page 33	→ Page 33	→ Page 33	→ Page 33

**Notes**

2) 0.3 for M22-DRL-...

# RMQ Titan Dimensions

## Actuators and indicators

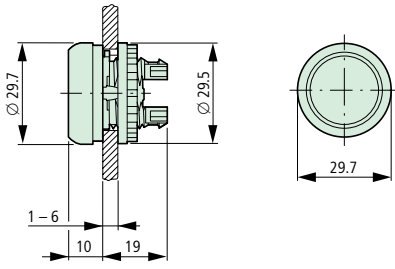

## Push-button actuators

M22-D

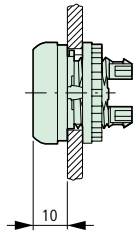

M22-DH

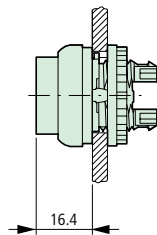

M22-DG

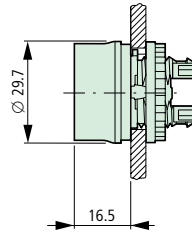

M22-DD

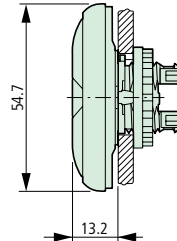

Push-button actuator in base fixing

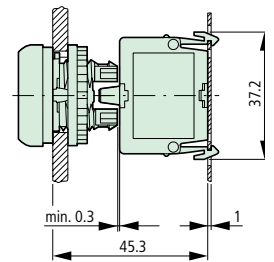

## Selector switch actuators

M22-W(R)...

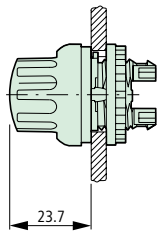

M22-W(R)K...  
M22-W(R)LK...

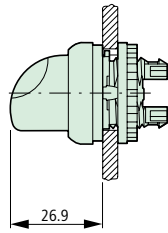

## Key-operated actuators Individual lock mechanism

M22(S)-W(R)S-(MS...)

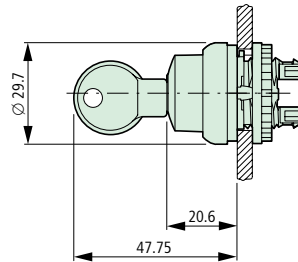

## Master key systems

M22(S)-W(R)S-SA...

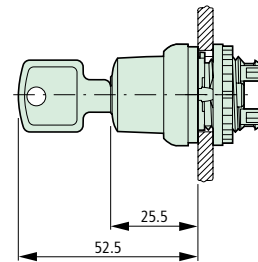

## Indicator lights

M22-LH

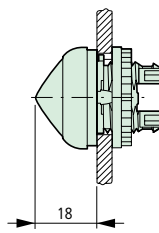

M22-L

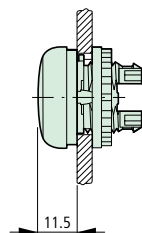

## Illuminated push-button actuators

M22-DL

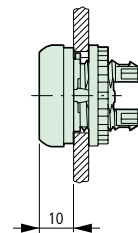

M22-DLH

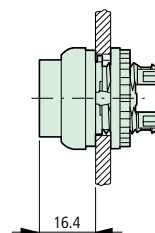

## Mushroom actuators

M22-DP

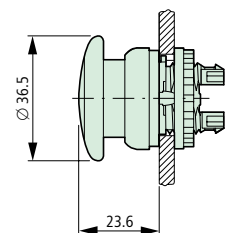

## Emergency-Stop actuator

M22-PV, M22S-PV  
M22-PVL, M22-PVS-...

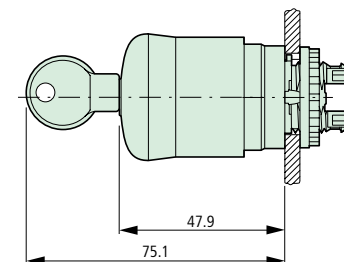



# RMQ Titan Dimensions

Front fixing (style: flush mounting)

## Fixing adapter

M22-A

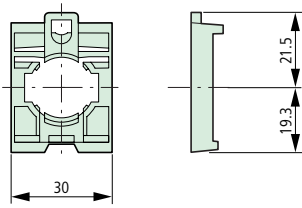

## Centring adapter

M22-ZA

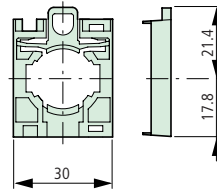

## Actuator with M22-(C)K...

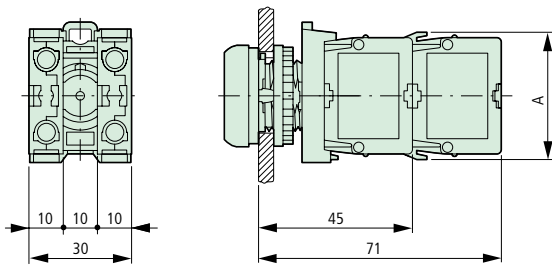

## Indicator light/Illuminated actuator

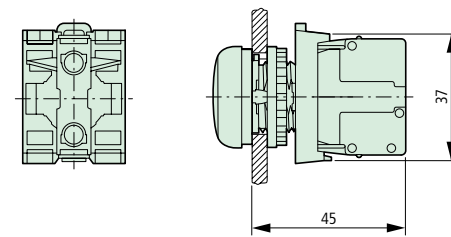

	1 × M22-K...	2 × M22-K...	1 × M22-CK...	2 × M22-CK...
A	37.2	37.2	39	39

## IVS Top-hat rail adapter

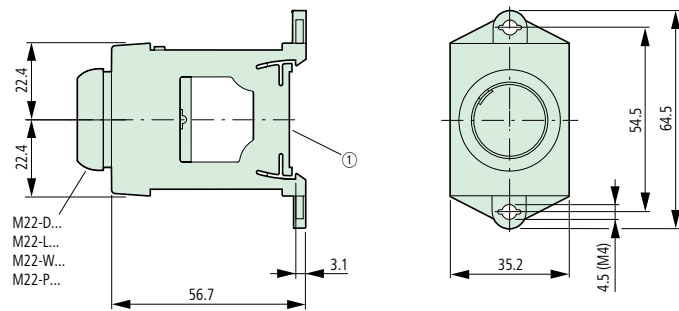

① For top-hat rails to EN 50 022

## Button, illuminated push-button, indicator light With telescopic clip

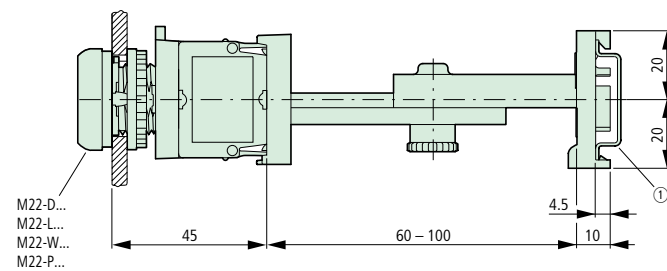

① Top-hat rail to EN 50 022

# RMQ Titan Dimensions

## Front fixing (style: flush mounting)

### Flush mounting panel M22-E...

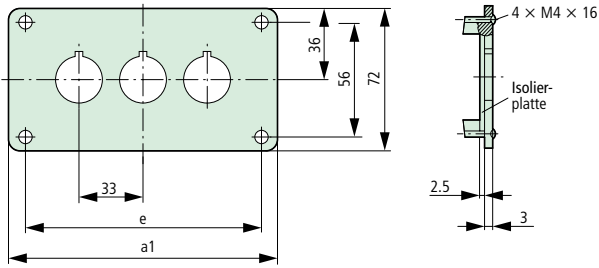

Type	a1	e
E (Y) 1	72	56
E 2	105	89
E 3	138	122
E 4	171	155
E 5	204	188
E 6	237	221

## Base fixing (style: surface mounting)

### Surface mounting enclosure M22-I...

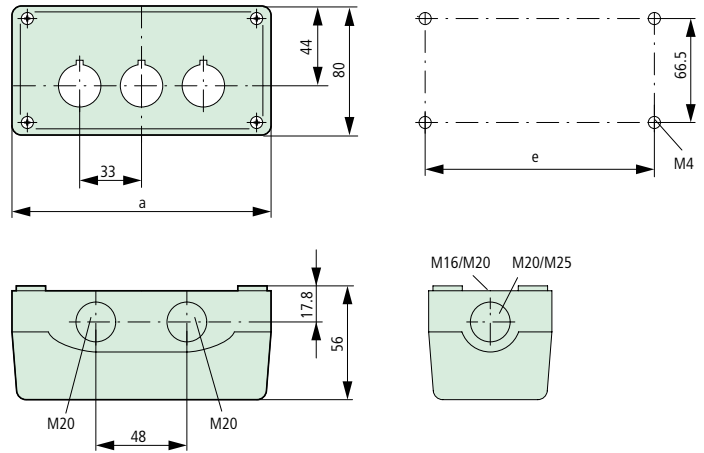

Type	Number of locations	a	e	Cable entries		
M22-I (Y) 1	1	72	58.5	2 × M16	3 × M20	2 × M25
M22-I2	2	120	106.5	2 × M16	3 × M20	2 × M25
M22-I3	3	153	139.5	2 × M16	2 × M25	4 × M20
M22-I4	4	186	172.5	2 × M16	2 × M25	4 × M20
M22-I6	6	252	238.5	2 × M16	2 × M25	4 × M20

## Shroud M22-H...

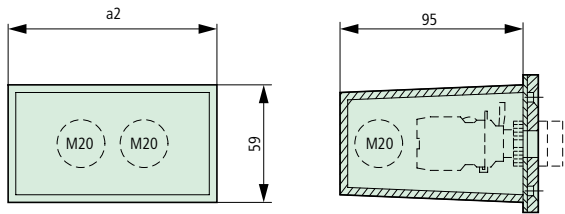

Type	a2	Cable entry	Style
H 1	42	3 × M20	One-part
H 2	75	4 × M20	
H 3	108	4 × M20	
H 4	141	4 × M20	Multi-part
H 5	174	5 × M20	
H 6	207	6 × M20	

## Shroud with plaster keys M22-UPE

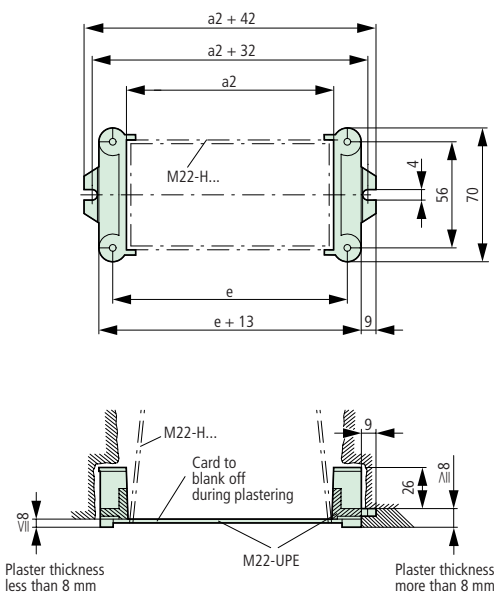

## Surface mounting enclosure for 12 locations M22-I12

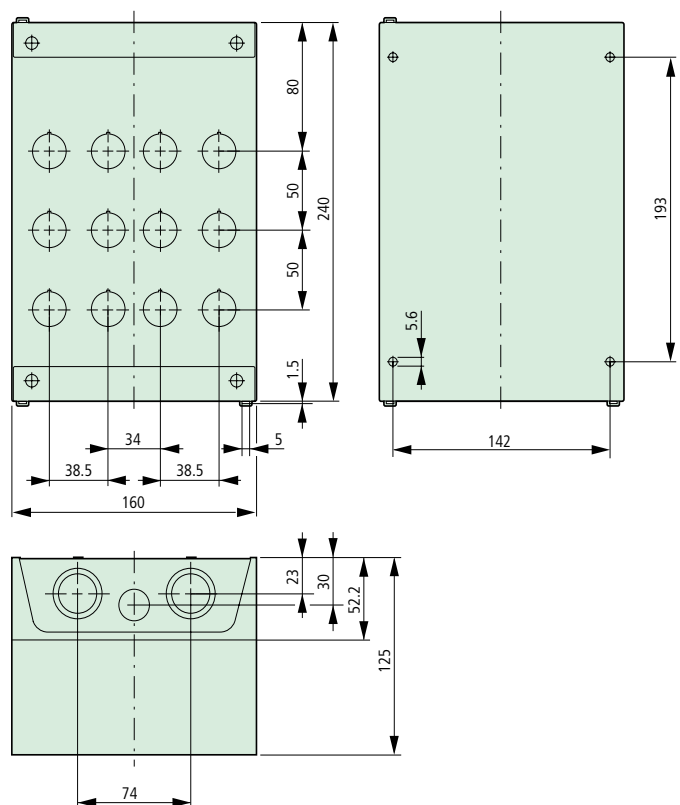

# RMQ Titan Dimensions

## Label mounts

M22-ST

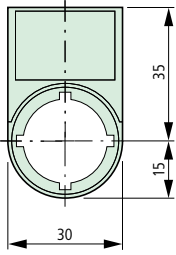

Grid dimension to IEC/EN 60 947

M22-STDD

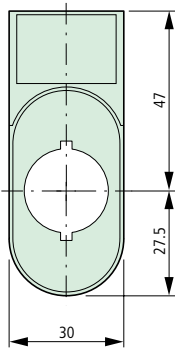

Minimal grid dimension

## Mounting holes with/without lug slot

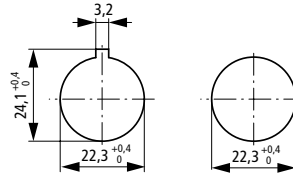

Grid dimension for different combinations

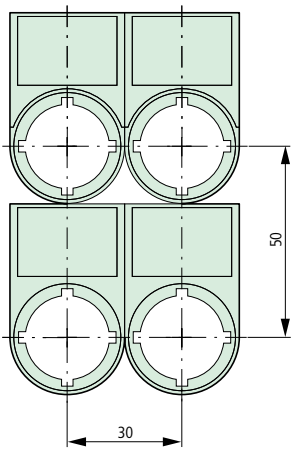

Grid dimension for M22-DD...

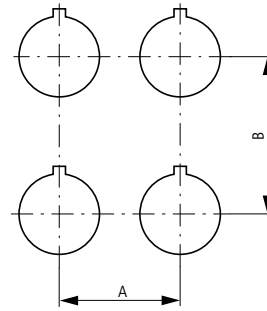
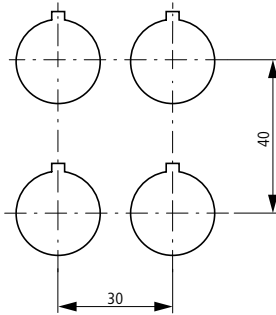

Do not use actuator diaphragm with label mounts since the mounts do not conform to IP 67.

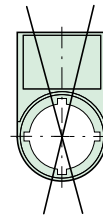

	A ≙	B ≙
IEC/EN 60 947	30	50
RMQ Titan min.	30	40
D + T-D	33	
DP	37	
D+DP	30	
PV	38	
PV+PL-PV	48	56
DD	30	55
DD+T-DD	33	58
DD+STDD	30	75

Grid dimension for QDD double actuators plus MT-DD diaphragms

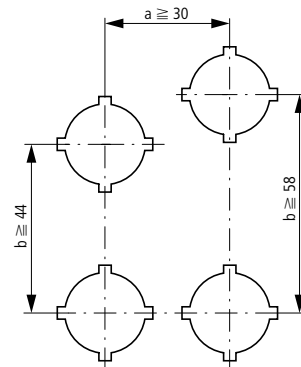
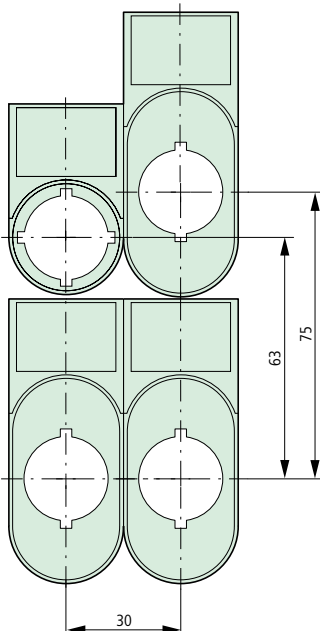

Do not use actuator diaphragm with label mounts since the mounts do not conform to IP 67.

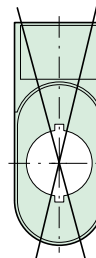

# RMQ Titan Dimensions

## Accessories

M22-PL-PV

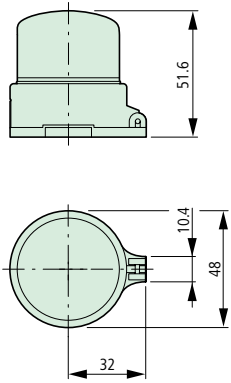

M22-B

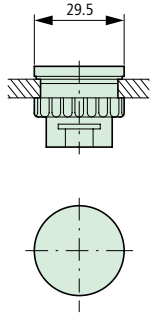

M22-T-D

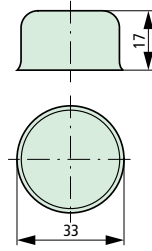

M22-T-DD

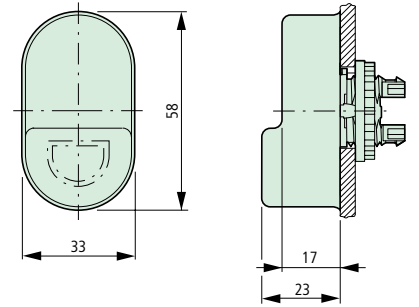

## Emergency-Stop label

M22-XAK

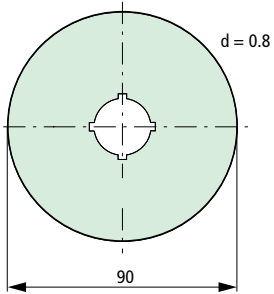

M22-XZK...

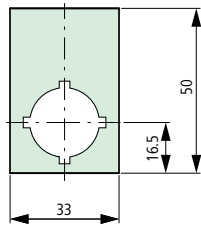

M22-XBK1

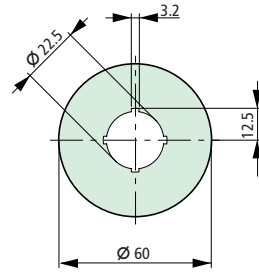

M22-XYK1

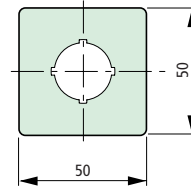

## RMQ Titan Conversion Table

Unit	Type RMQ22	New type RMQ Titan	Unit	Type RMQ22	New type RMQ Titan
<b>Push-button actuators</b>			<b>Double actuators</b>		
Flush, spring-return	RD-01	M22-D-S	Non-illuminated	QDD-X	M22-DD-GR
	RD-02	M22-D-W		QDD-11/10	M22-DD-GR-X1/X0
	RD-03	M22-D-R		QDD-111/110	M22-DD-GR-GB1/GB0
	RD-04	M22-D-G		QDD-X	M22-DD-WS
	RD-05	M22-D-Y		QDD-20/19	M22-DD-WS-X1/X0
	RD-06	M22-D-B		QDD-122/112	M22-DD-WS-GB1/GB0
	RD-X	M22-D-X		QDD-32/32	M22-DD-S-X7/X7
				QDD-37/38	M22-DD-S-X4/X5
	RD-10	M22-D-R-X0	Illuminated	QDDL-X	M22-DDL-GR
	RD-11	M22-D-G-X1		QDDL-11/10	M22-DDL-GR-X1/X0
	RD-19	M22-D-S-X0		QDDL-111/110	M22-DDL-GR-GB1/GB0
	RD-20	M22-D-W-X1		QDDL-X	M22-DDL-WS
				QDDL-20/19	M22-DDL-WS-X1/X0
				QDDL-122/112	M22-DDL-WS-GB1/GB0
		QDDL-32/32		M22-DDL-S-X7/X7	
		QDDL-37/38		M22-DDL-S-X4/X5	
Flush, stay-put	–	M22-DR-S	<b>Mushroom actuators</b>		
	–	M22-DR-W	Spring-return	RP-SW01	M22-DP-S
	–	M22-DR-R		RP-RT03	M22-DP-R
	–	M22-DR-G		RP-GN04	M22-DP-G
	–	M22-DR-Y		RP-GE05	M22-DP-Y
	–	M22-DR-B			
	–	M22-DR-X		RP-RT10	M22-DP-R-X0
	–	M22-DR-R-X0		RP-RT11	M22-DP-G-X1
	–	M22-DR-G-X1		RP-SW19	M22-DP-S-X0
	–	M22-DR-S-X0		RP-SW20	M22-DP-W-X1
	–	M22-DR-W-X1			
	Extended, spring-return	RDH-SW01	M22-DH-S	RP-SW-X	M22-DP-S-X
		–	M22-DH-W	RP-RT-X	M22-DP-R-X
		RDH-RT03	M22-DH-R	RP-GN-X	M22-DP-G-X
RDH-GN04		M22-DH-G	RP-GE-X	M22-DP-Y-X	
RDH-GE05		M22-DH-Y			
–		M22-DH-B	Stay-put	–	M22-DRP-S
RDH-RT10		M22-DH-R-X0		–	M22-DRP-R
RDH-GN11		M22-DH-G-X1		–	M22-DRP-G
RDH-SW19		M22-DH-S-X0		–	M22-DRP-Y
RDH-SW20		M22-DH-W-X1		–	M22-DRP-R-X0
		–		M22-DRP-G-X1	
		–		M22-DRP-S-X0	
		–		M22-DRP-W-X1	
		–		M22-DRP-S-X	
		–		M22-DRP-R-X	
Extended, stay-put	–	M22-DRH-S	–	M22-DRP-G-X	
	–	M22-DRH-W	–	M22-DRP-Y-X	
	–	M22-DRH-R			
	–	M22-DRH-G			
	–	M22-DRH-Y			
	–	M22-DRH-B			
	–	M22-DRH-R-X0			
	–	M22-DRH-G-X1			
	–	M22-DRH-S-X0			
	–	M22-DRH-W-X1			
With guard ring	RDK-X	M22-DG-X			
Emergency-Stop actuators	RPV	M22-PV			
	–	M22-PVL			
Emergency-Stop Key-operated actuators	RPSR	M22-PVS			
	RPSR-KMS...	M22-PVS-MS*			

## RMQ Titan Conversion Table

Unit	Type RMQ22	New type RMQ Titan	Unit	Type RMQ22	New type RMQ Titan	
<b>Illuminated push-button actuators</b>			<b>Illuminated selector switch actuators</b>			
Flush, spring-return	RLT-WS	M22-DL-W	Thumb-grip, Two positions, spring-return	RLWK1-WS	M22-WLK-W	
	RLT-RT	M22-DL-R		RLWK1-RT	M22-WLK-R	
	RLT-GN	M22-DL-G		RLWK1-GN	M22-WLK-G	
	RLT-GE	M22-DL-Y		RLWK1-GE	M22-WLK-Y	
	RLT-BL	M22-DL-B		RLWK1-BL	M22-WLK-B	
	–	M22-DL-X	Thumb-grip, Two positions, stay-put	RLWK1R-WS	M22-WRLK-W	
	–	M22-DL-R-X0		RLWK1R-RT	M22-WRLK-R	
	–	M22-DL-G-X1		RLWK1R-GN	M22-WRLK-G	
	–	M22-DL-W-X0		RLWK1R-GE	M22-WRLK-Y	
	RLT-WS11	M22-DL-W-X1		RLWK1R-BL	M22-WRLK-B	
Flush, stay-put	RLTR-WS	M22-DRL-W	Thumb-grip, Three positions, spring-return	RLWK3-WS	M22-WLK3-W	
	RLTR-RT	M22-DRL-R		RLWK3-RT	M22-WLK3-R	
	RLTR-GN	M22-DRL-G		RLWK3-GN	M22-WLK3-G	
	RLTR-GE	M22-DRL-Y		RLWK3-GE	M22-WLK3-Y	
	RLTR-BL	M22-DRL-B		RLWK3-BL	M22-WLK3-B	
	–	M22-DRL-X	Thumb-grip, Three positions, stay-put	RLWK3R-WS	M22-WRLK3-W	
	–	M22-DRL-R-X0		RLWK3R-RT	M22-WRLK3-R	
	–	M22-DRL-G-X1		RLWK3R-GN	M22-WRLK3-G	
	–	M22-DRL-W-X0		RLWK3R-GE	M22-WRLK3-Y	
	–	M22-DRL-W-X1		RLWK3R-BL	M22-WRLK3-B	
Extended, spring-return	RLTH-WS	M22-DLH-W	RLWK3R-...	M22-WRLK3-*/*		
	RLTH-RT	M22-DLH-R	<b>Indicator lights</b>			
	RLTH-GN	M22-DLH-G	Flush	RLF-WS	M22-L-W	
	RLTH-GE	M22-DLH-Y		RLF-RT	M22-L-R	
	RLTH-BL	M22-DLH-B		RLF-GN	M22-L-G	
	–	M22-DLH-R-X0		RLF-GE	M22-L-Y	
	–	M22-DLH-G-X1		RLF-BL	M22-L-B	
	–	M22-DLH-W-X0		–	M22-L-X	
	Extended, stay-put	RLTH-WS11	M22-DLH-W-X1	Extended	RL-WS	M22-LH-W
		–	M22-DRLH-W		RL-RT	M22-LH-R
–		M22-DRLH-R	RL-GN		M22-LH-G	
–		M22-DRLH-G	RL-GE		M22-LH-Y	
–		M22-DRLH-Y	RL-BL		M22-LH-B	
–		M22-DRLH-B	Compact, flush	–	M22-LC-W	
–		M22-DRLH-R-X0		–	M22-LC-R	
–		M22-DRLH-G-X1		–	M22-LC-G	
–		M22-DRLH-W-X0		–	M22-LC-Y	
–		M22-DRLH-W-X1		–	M22-LC-B	
Extended, stay-put	–	M22-DRLH-W-X1	–	M22-LC-X		
	–	M22-DRLH-W-X1	Compact, extended	–	M22-LCH-W	
	–	M22-DRLH-W-X1		–	M22-LCH-R	
	–	M22-DRLH-W-X1		–	M22-LCH-G	
	–	M22-DRLH-W-X1		–	M22-LCH-Y	
–	M22-DRLH-W-X1	–		M22-LCH-B		
			<b>Acoustic indicator</b>			
			–	M22-AM		

## RMQ Titan Conversion Table

Unit	Type RMQ22	New type RMQ Titan	Unit	Type RMQ22	New type RMQ Titan
<b>Key-operated actuators</b>			<b>LED elements</b>		
Two positions	RS-KMS1-A1	M22-WS	Screw terminal	EF + GL24	M22-LED-W
	RS-KMS...-A1	M22-WS-MS*		EF + GL24	M22-LED-R
	RS-SA(...)	M22-WS-SA(*)-*		EF + GL24	M22-LED-G
	RS	M22-WRS		EF + GL24	M22-LED-B
	RS-KMS...	M22-WRS-MS*		EFC + GL24	M22-LEDC-W
	RS-KMS...	M22-WRS-MS*-A1		EFC + GL24	M22-LEDC-R
	RS-SA(...)	M22-WRS-SA(*)-*		EFC + GL24	M22-LEDC-G
Three positions	RS3-KMS1-A1	M22-WS3		EFC + GL24	M22-LEDC-B
	RS3-KMS...-A1	M22-WS3-MS*		EF3 + GL130	M22-LED230-W
	RS3-SA(...)	M22-WS3-SA(*)-*		EF3 + GL130	M22-LED230-R
	RS3	M22-WRS3		EF3 + GL130	M22-LED230-G
	RS3-KMS...	M22-WRS3-MS*		EF3 + GL130	M22-LED230-B
	RS3-KMS...	M22-WRS3-MS*-A*		EF3C + GL130	M22-LEDC230-W
	RS3-SA(...)	M22-WRS3-SA(*)-*	EF3C + GL130	M22-LEDC230-R	
<b>Replacement key</b>			EF3C + GL130	M22-LEDC230-G	
Individual lock mechanism MS1	ES-KMS1	M22-ES-MS1	EF3C + GL130	M22-LEDC230-B	
Individual lock mechanism MS2-20	ES-KMS...	M22-ES-MS*	Cage Clamp		
for SA(...)	ES-NS...	M22-ES-SA(*)-*	–	M22-CLED-W	
<b>Selector switch actuators</b>			–	M22-CLED-R	
Rotary head, Two positions	RW1	M22-W	–	M22-CLED-G	
	RW1R	M22-WR	–	M22-CLED-B	
	RW1R+92T	M22-WR-X92	–	M22-CLED230-W	
	RW1R+97T	M22-WR-X91	–	M22-CLED230-R	
Rotary head, Three positions	RW3	M22-W3	–	M22-CLED230-G	
	RW3R	M22-WR3	–	M22-CLED230-B	
Thumb-grip, Two positions	RWK1	M22-WK	–	M22-CLED230-W	
	RWK1R	M22-WRK	–	M22-CLED230-R	
Thumb-grip, Three positions	RWK3	M22-WK3	–	M22-CLED230-G	
	RWK3R	M22-WRK3	–	M22-CLED230-B	
	RWK3R-...	M22-WRK3-*	–	M22-CLED230-W	
V position	RWK1V	M22-WKV	–	M22-CLED230-R	
<b>Functional elements</b>			–	M22-CLED230-G	
Make contact, Screw terminal	EK10	M22-K10	–	M22-CLED230-B	
	EK10C	M22-KC10	<b>Functional elements</b>		
Break contact, Screw terminal	EK01	M22-K01	Make contact, Screw terminal	EK10	M22-K10
	EK01C	M22-KC01	Break contact, Screw terminal	EK10C	M22-KC10
Make contact, Cage Clamp	–	M22-CK10	Make contact, Cage Clamp	–	M22-CK10
	–	M22-CKC10	Break contact, Cage Clamp	–	M22-CKC10
Break contact, Cage Clamp	–	M22-CK01	Make contact, Cage Clamp	–	M22-CK10
	–	M22-CKC01	Break contact, Cage Clamp	–	M22-CKC10
Fixing adapter (front)	BE3, BE6	M22-A	<b>Functional elements</b>		

## RMQ Titan Conversion Table

Unit	Type RMQ22	New type RMQ Titan	Unit	Type RMQ22	New type RMQ Titan
<b>Enclosures</b>			<b>Button lenses, Illuminated</b>		
Surface mounting enclosure	I1M	M22-I1	Push-button actuator, flush	LLT-WS	M22-XDL-W
	IGE1M	M22-IY1		LLT-RT	M22-XDL-R
	I2M	M22-I2		LLT-GN	M22-XDL-G
	I3M	M22-I3		LLT-GE	M22-XDL-Y
	I4M	M22-I4		LLT-BL	M22-XDL-B
	I5M	M22-I6		Sond	M22-XDL-*. *
	I12M	M22-I12	Push-button actuator, extended	LLTH-WS	M22-XDLH-W
Flush mounting panel	E1M	M22-E1		LLTH-RT	M22-XDLH-R
	EGE1M	M22-EY1		LLTH-GN	M22-XDLH-G
	E2M	M22-E2		LLTH-GE	M22-XDLH-Y
	E3M	M22-E3		LLTH-BL	M22-XDLH-B
	E4M	M22-E4		Sond	M22-XDLH-*. *
	E5M	M22-E5	<b>Lenses, Indicator lights</b>		
	E6M	M22-E6	Flush	LLF-WS	M22-XL-W
Shroud	H1M	M22-H1		LLF-RT	M22-XL-R
	H2M	M22-H2		LLF-GN	M22-XL-G
	H3M	M22-H3		LLF-GE	M22-XL-Y
	H4M	M22-H4		LLF-BL	M22-XL-B
	H5M	M22-H5		Sond	M22-XL-*. *
	H6M	M22-H6	Extended	LL-WS	M22-XLH-W
Plaster Fixing key	UPE	M22-UPE		LL-RT	M22-XLH-R
	<b>Button plates, Non-illuminated</b>			LL-GN	M22-XLH-G
Push-button actuators, flush	01T	M22-XD-S		LL-GE	M22-XLH-Y
	02T	M22-XD-W		LL-BL	M22-XLH-B
	03T	M22-XD-R	<b>Emergency-Stop labels</b>		
	04T	M22-XD-G	1AK	M22-XAK	
	05T	M22-XD-Y	1AK-...	M22-XAK1	
	06T	M22-XD-B	1AK-...	M22-XAK2	
	Sond	M22-XD-*. *	1AK-...	M22-XAK3	
Push-button actuators, extended	01T	M22-XDH-S	1AK-...	M22-XAK4	
	02T	M22-XDH-W	Sond	M22-XAK-*	
	03T	M22-XDH-R	SR22	M22-XBK1	
	04T	M22-XDH-G	SQ22	M22-XYK1	
	05T	M22-XDH-Y	ZK05	M22-XZK	
	06T	M22-XDH-B	ZK-199	M22-XZK-D99	
	Sond	M22-XDH-*. *	ZK-299	M22-XZK-GB99	
Mushroom actuator	01T	M22-XDP-S	ZK-399	M22-XZK-F99	
	02T	M22-XDP-W	ZK-899	M22-XZK-199	
	03T	M22-XDP-R	ZK-599	M22-XZK-NL99	
	04T	M22-XDP-G	ZK-499	M22-XZK-S99	
	05T	M22-XDP-Y	ZK-699	M22-XZK-SF99	
	Sond	M22-XDP-*. *	ZK-1099	M22-XZK-DK99	
	Sond		Sond	M22-XZK-*	
Insert plate For label mounts				XB	M22-XST
				Sond	M22-XST-*



## RMQ Titan Conversion Table

Unit	Type RMQ22	New type RMQ Titan	Unit	Type RMQ22	New type RMQ Titan		
Legend plate complete	RBS-90	M22S-ST-X88	<b>Accessories</b>	Blanking plug	RB22G	M22-B	
	RBS-98	M22S-ST-X89		Blanking plug	RB22S	M22S-B	
	RBS-93	M22S-ST-X93		Legend plate Label mounts; without label	RBS-X	M22S-ST-X	
	RBS-117	M22S-ST-D5		Legend plate Label mounts f. DD(L)	QBS-X	M22S-STDD-X	
	RBS-121	M22S-ST-D6		Actuator protective diaphragm	MT-D	M22-T-D	
	RBS-183	M22S-ST-D7		Actuator protective diaphragm	MT-DD	M22-T-DD	
	RBS-150	M22S-ST-D8		Sealable shroud	PL-RPV	M22-PL-PV	
	RBS-196	M22S-ST-D10		Telescopic clip	TC-RMQ	M22-TC	
	RBS-195	M22S-ST-D11		Centring adapter	BE3Z	M22-ZA	
	RBS-197	M22S-ST-D12		IVS Top-hat rail adapter	–	M22-IVS	
	RBS-110	M22S-ST-GB0		Threading ring	GR22	M22-GR	
	RBS-111	M22S-ST-GB1		Combination box spanner	R22-MS	M22-MS	
	RBS-217	M22S-ST-GB5		Bulb extractor	R22-MS	M22-LG	
	RBS-221	M22S-ST-GB6		Plunger bridge	–	M22-XW	
	RBS-283	M22S-ST-GB7		Coding adapter	SP-RMQ-RT	M22-XC-R	
	RBS-250	M22S-ST-GB8		Coding adapter	SP-RMQ-GE	M22-XC-Y	
	RBS-296	M22S-ST-GB10		Set of adapter rings 30/22.5mm	R22/30-SW	M22S-R30	
	RBS-395	M22S-ST-GB11		Fixing plate	Z2116-171.03.5	M22-XE5	
	RBS-397	M22S-ST-GB12					
	Complete modules	BK01		M22-AK01			
		BK10		M22-AK10			
BK11		M22-AK11					
Complete units	QDD-11/10/K11	M22-DD-GR-X1/X0/K11					
	QDDL-11/10/K11/F	M22-DDL-GR-X1/X0/K11/230-W					
	RD-10/K01	M22-D-R-X0/K01					
	RD-10/K11	M22-D-R-X0/K11					
	RD-11/K10	M22-D-G-X1/K10					
	RD-11/K11	M22-D-G-X1/K11					
	RPSR/K01	M22-PVS/K01					
	RPV/K01	M22-PV/K01					
	RPV/K11	M22-PV/K11					
	RS/K11	M22-WRS/K11					
	RWK1R/K10	M22-WRK/K10					
	RWK1R/K11	M22-WRK/K11					
	RWK3R/K20	M22-WRK3/K20					
	RD-10/KC/I	M22-D-R-X0/KC11/I					
	RD-11/KC/I	M22-D-G-X1/KC11/I					
	RPSR/KC/I	M22-PVS/KC11/IY					
	RPV/K02C/I	M22-PV/KC02/IY					
	RPV/KC/I	M22-PV/KC11/IY					
	RS/KC/I	M22-WRS/KC11/I					
	1M/I	M22-I1-M1					
	1M/IGE	M22-I1Y-M1					
	R2M/I	M22-I2-M1					
	R3M/I	M22-I3-M1					
	R3M-L/I	M22-I3-M2					
	R4M/I	M22-I4-M1					

## X-ON Electronics

Largest Supplier of Electrical and Electronic Components

*Click to view similar products for [LED Lighting Mounting Accessories](#) category:*

*Click to view products by [Eaton](#) manufacturer:*

Other Similar products are found below :

[C16142\\_HEKLA-SOCKET-K](#) [3SU1401-1BF20-3AA0](#) [3SU1401-1BF60-3AA0](#) [3SU1900-0BC31-0AA0](#) [3SU1900-0BC31-0NB0](#) [2213118-2](#)  
[3SU1401-2BB20-1AA0](#) [3SU1401-2BB40-1AA0](#) [3SU1401-2BB60-1AA0](#) [3SU1401-2BB60-3AA0](#) [1SFA616921R2131](#) [1SFA616921R2132](#)  
[1SFA616921R2133](#) [1SFA611621R1033](#) [1SFA611621R1091](#) [23110022](#) [23110040](#) [23120022](#) [23130000](#) [68550022](#) [68550040](#) [70290000](#)  
[70290022](#) [70290040](#) [70300022](#) [76620000](#) [76990022](#) [77280022](#) [77980022](#) [77990001](#) [77990002](#) [77990040](#) [83130001](#) [83130040](#) [83150001](#)  
[83150022](#) [83150040](#) [83980001](#) [83980040](#) [83990001](#) [83990022](#) [83990040](#) [84040022](#) [84510002](#) [86050038](#) [86180003](#) [89080002](#) [89080022](#)  
[89140002](#) [89980002](#)