

loudity

SMT67



MATERIALS

Color - Black
Plastic Material - LCP
Terminal - SMD Type

Weight

approx. 0.5 gm.

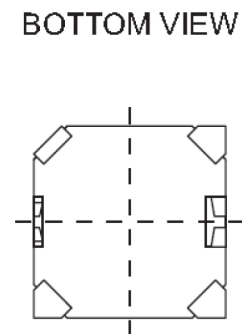
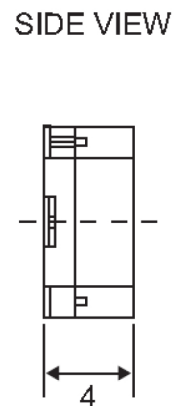
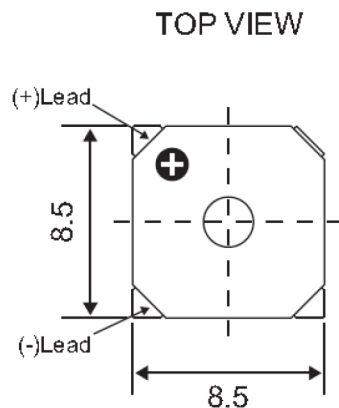

All dimensions are in mm
Unspecified Tolerance are +/-0.5mm

Model	Unit	LD-BZEL-T67-0808
Operating Voltage	Vo-p	2 ~ 4
Rated Voltage	Vo-p	3
* Max. Rated Current	mA.	80
Coil Resistance	ohm	16 +/- 3
* Min. Sound Output at 10cm	dBA	89
Resonant Frequency	Hz	2700
Operating Temperature	°C	-30 ~ +70

X-ON Electronics

Largest Supplier of Electrical and Electronic Components

Click to view similar products for [Audio Indicators & Alerts](#) category:

Click to view products by [Loudity](#) manufacturer:

Other Similar products are found below :

[M2BJ-BH24E](#) [6-4](#) [68S1240-PA](#) [MBA-624](#) [F/BC 40P-DR LF](#) [FDG111PLF](#) [F/NRMB 24 BLACK LF](#) [PF-35N29WQ](#) [PFD-27A35PQ](#) [PL-27A35PSQ](#) [PS-531Q](#) [AB2020B-2-LW1](#) [EBPT-401](#) [PB06SD12AP](#) [PB-1220PEQ](#) [S6109](#) [SC2036ACP](#) [SC616N-2](#) [SC628FW](#) [SC628MPG](#) [SC648D](#) [SCS045MD9DT3S](#) [AB2025B-LW50-R](#) [ESZ-25B-5-250B](#) [F/BC 35-DR LF](#) [FCM12PLF](#) [F/EB20P-DR LF](#) [F/HU110MP24V-IP67B LF](#) [AI-2835-TF-LW150-2-R](#) [AI-4228-TF-LW305-R](#) [FSMD8585JSLF](#) [FSS-26T](#) [F/SU 21-02 LF](#) [F/TCW 05 WITH LABEL LF](#) [F/UCW 03 WITH LABEL LF](#) [F/UCW 06 WITH LABEL LF](#) [PKM22EPPH40S1-B0](#) [PKM35-4A0](#) [PL-35N29WQ](#) [PLD-27A35PQ](#) [PS-552Q](#) [CM-5](#) [M2BJ-BH24E-D](#) [REF-202](#) [LSC628ANR](#) [5-100 PAL-328](#) [03-810.001](#) [RTO-1R07-001](#) [PL-21N31PQ](#) [PF-27A25PSQ](#)